





# TruVision Outdoor IP Camera Installation Manual

<b>Copyright</b>	© 2013 UTC Fire & Security Americas Corporation, Inc. Interlogix is part of UTC Climate Controls & Security, a unit of United Technologies Corporation. All rights reserved.
<b>Trademarks and patents</b>	The Product Name and logo are trademarks of United Technologies. Other trade names used in this document may be trademarks or registered trademarks of the manufacturers or vendors of the respective products.
<b>Manufacturer</b>	UTC Fire & Security Americas Corporation, Inc. 2955 Red Hill Avenue, Costa Mesa, CA 92626-5923, USA Authorized EU manufacturing representative: UTC Fire & Security B.V. Kelvinstraat 7, 6003 DH Weert, The Netherlands
<b>Certification</b>	 N4131
<b>FCC compliance</b>	<p><b>Class B:</b> This equipment has been tested and found to comply with the limits for a Class B digital device, pursuant to part 15 of the FCC Rules. These limits are designed to provide reasonable protection against harmful interference in a residential installation. This equipment generates, uses, and can radiate radio frequency energy and, if not installed and used in accordance with the instructions, may cause harmful interference to radio communications.</p> <p>There is no guarantee that interference will not occur in a particular installation. If this equipment does cause harmful interference to radio or television reception, which can be determined by turning the equipment off and on, the user is encouraged to try to correct the interference by one or more of the following measures:</p> <ul style="list-style-type: none"> <li>• Reorient or relocate the receiving antenna.</li> <li>• Increase the separation between the equipment and receiver.</li> <li>• Connect the equipment into an outlet on a circuit different from that to which the receiver is connected.</li> <li>• Consult the dealer or an experienced radio/TV technician for help.</li> </ul>
<b>ACMA compliance</b>	<b>Notice!</b> This is a Class A product. In a domestic environment this product may cause radio interference in which case the user may be required to take adequate measures.
<b>Canada</b>	This Class A digital apparatus complies with Canadian ICES-003. Cet appareil numérique de la classe A est conforme à la norme NMB-0330 du Canada.
<b>European Union directives</b>	<p><b>12004/108/EC (EMC directive):</b> Hereby, UTC Fire &amp; Security declares that this device is in compliance with the essential requirements and other relevant provisions of Directive 2004/108/EC.</p> <p><b>2002/96/EC (WEEE directive):</b> Products marked with this symbol cannot be disposed of as unsorted municipal waste in the European Union. For proper recycling, return this product to your local supplier upon the purchase of equivalent new equipment, or dispose of it at designated collection points. For more information see: <a href="http://www.recyclethis.info">www.recyclethis.info</a>.</p>
<b>Contact information</b>	  <p>For contact information, see <a href="http://www.interlogix.com">www.interlogix.com</a> or <a href="http://www.utcssecurityproducts.eu">www.utcssecurityproducts.eu</a>.</p>

# Content

## **Introduction 3**

Product overview 3

Features 4

## **Installation 4**

Installation environment 4

Package contents 5

Cable requirements 5

Camera description 6

Setting up the camera 7

Connecting the devices 8

Accessing the SD card 9

Mounting the dome camera 9

Mounting the bullet camera 13

Using the camera with an Interlogix NVR or Hybrid DVR or another system 15

Using the camera with TruVision Navigator 15

## **Specifications 15**

TruVision outdoor IP dome cameras 15

TruVision outdoor IP bullet cameras 16

## **Pin definitions 17**

# Introduction

## **Product overview**

This is the user manual for TruVision Outdoor IP camera models:

- TVC-N225E-2M-N(-P) (IP bullet camera)
- TVC-M1245E-2M-N(-P) (1.3MPX WDR bullet camera)
- TVC-M3245E-2M-N(-P) (3MPX WDR bullet camera)
- TVC-M5225E-3M-N(-P) (5MPX bullet camera)
- TVD-N225E-2M-N(-P) (IP dome camera)
- TVD-M1245E-2M-N(-P) (1.3MPX WDR dome camera)
- TVD-M3245E-2M-N(-P) (3MPX WDR dome camera)
- TVD-M5225E-3M-N(-P) (5MPX dome camera)

## Features

This section describes the camera features.

- Supports TCP/IP, HTTP, DHCP, DNS, DDNS, RTP/RTSP, PPPoE, SMTP, NTP, UPnP, ICMP, IGMP, SNMP, FTP, 802.1x, QoS, HTTPS protocols
- Programming and setup through a browser interface
- Live viewing over the network
- 50/60 Hz selectable flicker control
- 120dB Wide Dynamic Range (WDR models only)
- Motorized lens with zoom function
- Auto focus
- Supports remote upgrades and maintenance
- H.264 video compression with dual capability
- Supports HD (5MPX, 3MPX and 1.3MPX models), VGA,
- IP66 weather proof
- Micro SD card for local storage (dome cameras only)
- Designed to ONVIF and PSIA open standards



## Installation

This chapter provides information on how to install the cameras.

### Installation environment

When installing your product, consider these factors:

- **Electrical:** Install electrical wiring carefully. It should be done by qualified service personnel. Always use a proper PoE switch or a 12 VDC UL listed Class 2 or CE certified power supply to power the bullet camera, and a proper PoE / PoE+ switch, a 24 VAC UL listed Class 2, or CE certified power supply to power the camera. Do not overload the power cord or adapter.
- **Ventilation:** Ensure that the location planned for the installation of the camera is well ventilated.
- **Temperature:** Do not operate the camera beyond the specified temperature, humidity or power source ratings. The operating temperature of the camera is between -10 to +60°C (14 to 140°F). Humidity is below 90%.

- **Moisture:** Do not expose the camera to rain or moisture, or try to operate it in wet areas. Turn the power off immediately if the camera is wet and ask a qualified service person for servicing. Moisture can damage the camera and also create the danger of electric shock.
- **Servicing:** Do not attempt to service this camera yourself. Any attempt to dismantle or remove the covers from this product will invalidate the warranty and may also result in serious injury. Refer all servicing to qualified service personnel.
- **Cleaning:** Do not touch the sensor modules with fingers. If cleaning is necessary, use a clean cloth with some ethanol and wipe the camera gently. If the camera will not be used for an extended period of time, put on the lens cap to protect the sensors from dirt.

## Package contents

Check the package and contents for visible damage. If any components are damaged or missing, do not attempt to use the unit; contact the supplier immediately. If the unit is returned, it must be shipped back in its original packaging.

Package contents:

- Camera
- Hex wrench
- Installation manual
- CD with Configuration Manual and TruVision Device Finder

---

**CAUTION:** Use direct plug-in UL listed power supplies marked Class 2/CE certified or LPS (limited power source) of the required output rating as listed on the unit.

---

## Cable requirements

For proper operation, adhere to the following cable and power requirements for the cameras. Category 5 cabling or better is recommended. All network cabling must be installed according to applicable codes and regulations.

Table 1 below lists the requirements for the cables that connect to the camera.

**Table 1: Recommended power cable requirements**

---

Bullet camera:	12 VDC power jack or PoE (802.3af)
Dome camera:	24 VAC power jack or High PoE (802.3at)

---

## Camera description

Figure 1: Outdoor IP dome camera

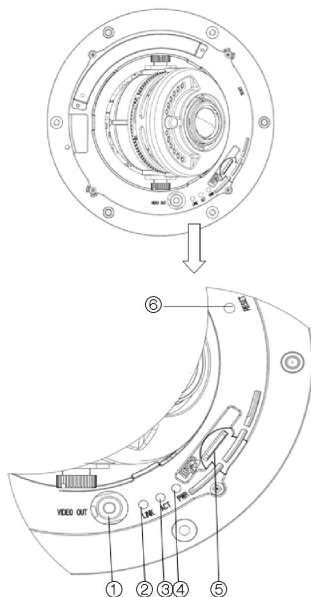

1. Video output interface
2. LINK LED: The yellow LED is lit when the network is connected.
3. ACT LED: The blue LED blinks when the network is correctly functioning.
4. PWR LED: The red LED is lit when the camera is powered up.
5. Micro SD card slot
6. Reset switch.

**Figure 2: Outdoor IP bullet camera**

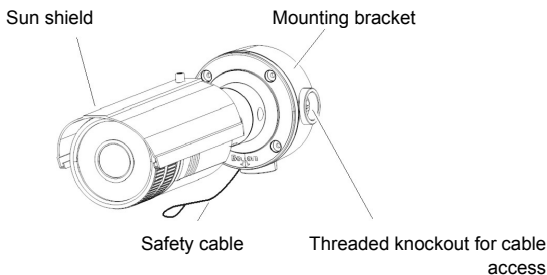

## Setting up the camera

**Note:** If the light source where the camera is installed experiences rapid, wide-variations in lighting, the camera may not operate as intended.

### To quickly put the dome camera into operation:

1. Prepare the mounting surface.
2. Connect the power cable (optional), alarm I/O cables, and network cable to the camera. See “Connecting the devices” on page 8.
3. Mount the camera to the ceiling using the appropriate fasteners. See “Mounting the dome camera” on page 9.
4. Set up the camera’s network and streaming parameters so that the camera can be controlled over the network. For further information, please refer to the “TruVision IP Camera Configuration Manual”.
5. Program the camera to suit its location. For further information, please refer to the “TruVision IP Camera Configuration Manual”.

### To quickly put the bullet camera into operation:

1. Prepare the mounting surface.
2. Connect the power and network cables to the camera. See “Connecting the devices” on page 8.
3. Mount the camera to the ceiling using the appropriate fasteners. See “Mounting the bullet camera” on page 13.
4. Set up the camera’s network and streaming parameters so that the camera can be controlled over the network. For further information, please refer to the “TruVision IP Camera Configuration Manual”.
5. Program the camera to suit its location. For further information, please refer to the “TruVision IP Camera Configuration Manual”.

## Connecting the devices

A qualified service person, complying with all applicable codes, should perform all required hardware installation.

**Note:** Do not attempt to extend the power/data cable connection using RJ45 couplers and Cat5 cable. Only use the data cable connection provided.

**Note:** Use 24 VAC or PoE/PoE+. The built-in heater requires the camera to be powered by 24 VAC or PoE+ in order to operate. When powered by standard PoE, the heater is disabled but the camera still functions normally.

**Figure 3: Connections on the base of the dome and IR dome cameras**

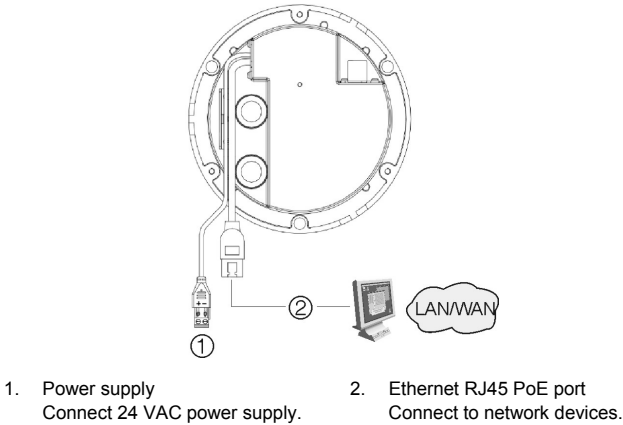

**Figure 4: Connections of the bullet cameras**

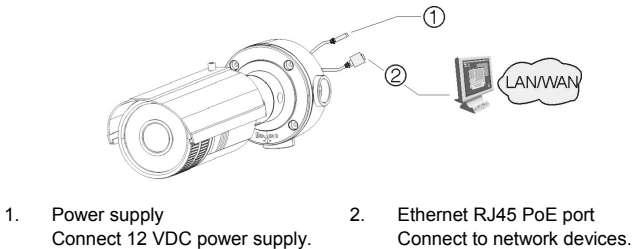



## Accessing the SD card

Insert a Micro SD card up to 32GB for local storage as a backup in case the network fails, for example (see Figure 1 on page 6). The card is not supplied with the camera.

Video and log files stored on the Micro SD card can only be accessed via the Web browser. You cannot access the card using TruVision Navigator or a recording device.

**Note:** There is no Micro SD card slot in the bullet cameras.

## Mounting the dome camera

Mount the dome camera on a ceiling or wall.

**To mount the dome on a ceiling:**

1. Use the supplied template to mark out the mounting area. Drill the screw holes on the ceiling. If you need to route the cables from the camera base, cut a cable hole in the ceiling.

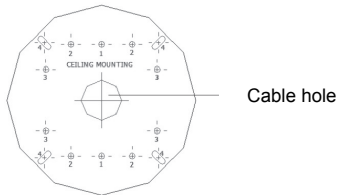

2. Secure the housing to the ceiling with screws.

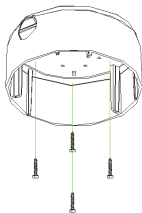
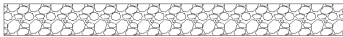

3. Loosen the screws on the dome enclosure (1) using the supplied hex wrench and remove the enclosure and the dome liner (2).

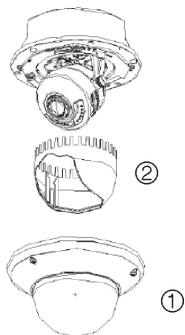

4. Insert the dome module into the housing and pull the camera's cables through the threaded knockout on the base of the housing.

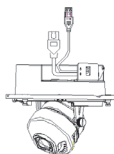

**Note:** The cables can also be passed through the threaded side knockout of the housing. Use a waterproof conduit for the cables and seal all joints to ensure so that no moisture can leak into the mounting surface.

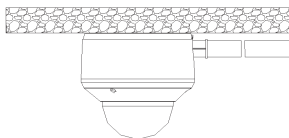

Side knockout

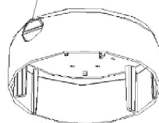

5. Connect the network and power cables.
6. While viewing the video on the monitor, adjust horizontally and vertically the camera pan and tilt. Adjust the lens focus to get optimal video effect.

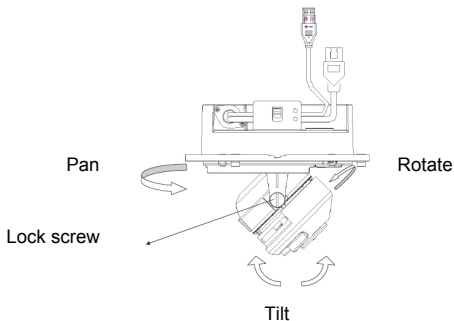

7. Reattach the dome liner and enclosure.

**To mount the dome on a wall:**

1. Use the supplied template to mark out the mounting area. Drill the screw holes on the wall. If you need to route the cables from the camera base, cut a cable hole in the wall.

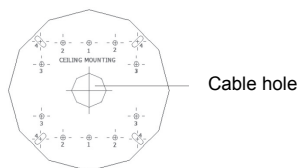

2. Secure the housing to the wall with screws.

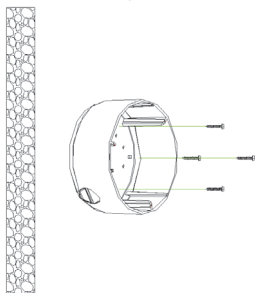

**Note:** Position the threaded side knockout facing downwards to prevent moisture from entering the camera.

3. Loosen the screws on the dome enclosure (1) using the supplied hex wrench and remove the enclosure and the dome liner (2).

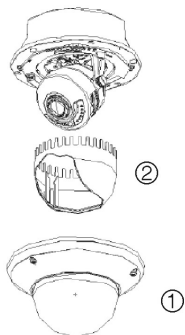

4. Insert the dome module into the housing and pull the camera's cables through the threaded knockout on the base of the housing.

**Note:** The cables can also be passed through the threaded side knockout of the housing. Use a waterproof conduit for the cables and seal all joints to ensure so that no moisture can leak into the mounting surface.

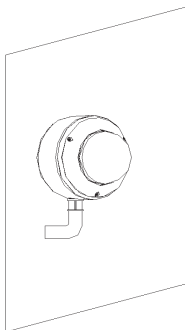

5. While viewing the video on the monitor, adjust horizontally and vertically the camera pan and tilt. Adjust the lens focus to get optimal video effect.

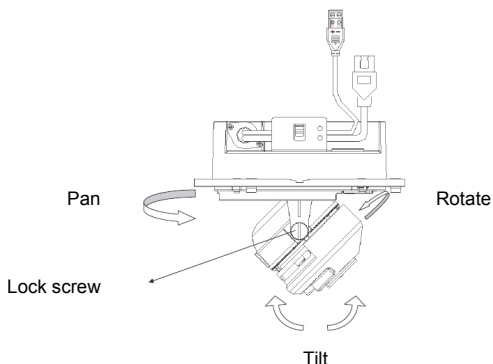

6. Reattach the dome liner and enclosure.

## Mounting the bullet camera

To mount the camera on a pole:

1. Securely fasten TVD-M-PMA pole mount accessory to the pole at desired mounting place, with cables prepared near to the camera.

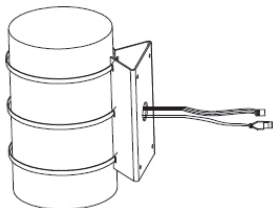

2. Connect a Cat5e cable to the network cable, and connect a 12 VDC power supply to the power cable.
3. Use TVD-M-PMA enclosed TM4\*16mm screws to attach the camera.
4. Adjust the camera position and angle as required.

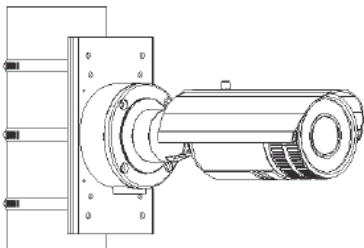

**To mount the camera on a wall:**

1. Use the mounting bracket as a template to mark out the mounting area.
2. Drill the screw holes on the wall. If you need to route the cables from the camera base, cut a cable hole in the wall.
3. Connect a Cat5e cable to the network cable, and connect a 12 VDC power supply to the power cable.
4. Secure the mounting bracket to the wall with screws.
5. Fix the camera to the mounting base with screws.

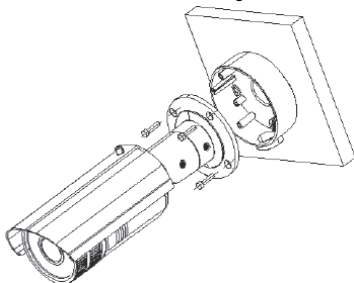

6. Adjust the camera position and angle as required.

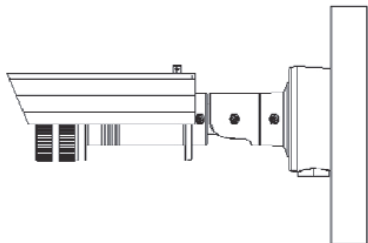

## Using the camera with an Interlogix NVR or Hybrid DVR or another system

Please refer to the NVR/DVR user manuals for instructions on connecting and operating the camera with these systems.

## Using the camera with TruVision Navigator

A camera must be connected to an Interlogix NVR or hybrid DVR in order to be operated by TruVision Navigator. Please refer to the TruVision Navigator user manual for instructions on operating the camera with the TruVision Navigator.

## Specifications

### TruVision outdoor IP dome cameras

---

#### Electrical

---

Voltage input	24 VAC $\pm$ 10% PoE (IEEE 802.3af - heater will be disabled) High PoE (802.3at)
Power consumption	Max. 12 W (w/o heater) Max. 24 W (heater on)

---

#### Miscellaneous

---

Connectors	AC jack flying lead, RJ45 flying lead
Operating temperature	-40 to 60 °C (-40 to 140 °F) with heater and fan on
Dimensions (D $\times$ H)	$\Phi$ 159.8 $\times$ 146 mm ( $\Phi$ 6.29 $\times$ 5.75 in.)
Weight	2100 g (4.62 lbs)
Environmental rating	IP66

---

#### Network

---

Protocols	TCP/IP, HTTP, DHCP, DNS, DDNS, RTP/RTSP, PPPoE, SMTP, NTP, UPnP, ICMP, IGMP, SNMP, FTP, 802.1x, QoS, HTTPS
-----------	--

---

---

**PC requirements**

---

Intel-based PC	1 GHz or faster
Memory	1 GB RAM
Operating system	Windows® XP, Vista or Windows 7
CGI	Direct X 9.0 or later
Browser	Microsoft Internet Explorer 6.0 or later

---

---

**TruVision outdoor IP bullet cameras**

---

**Electrical**

---

Voltage input	12 VDC, PoE (IEEE 802.3af)
Power consumption	Max. 12 W

---

**Miscellaneous**

---

Connectors	DC jack flying lead, RJ45 flying lead
Operating temperature	-10 to 60 °C (14 to 140 °F)
Dimensions (L × W × H)	98 × 88.58 × 328.79 mm (3.86 × 3.49 × 12.94 in.)
Weight	1700 g (3.75 lbs)
Environmental rating	IP66

---

**Network**

---

Protocols	TCP/IP, HTTP, DHCP, DNS, DDNS, RTP/RTSP, PPPoE, SMTP, NTP, UPnP, ICMP, IGMP, SNMP, FTP, 802.1x, QoS, HTTPS
-----------	--

---

**PC requirements**

---

Intel-based PC	1 GHz or faster
Memory	1 GB RAM
Operating system	Windows® XP, Vista or Windows 7
CGI	Direct X 9.0 or later
Browser	Microsoft Internet Explorer 6.0 or later









---



















## Pin definitions

There are eight wires on a standard UTP/STP cable and each wire is color-coded. The following shows the pin allocation and color of straight and crossover cable connection:

**Figure 5: Straight-through cable**

1	White/Orange		White/Orange	1
2	Orange		Orange	2
3	White-Green		White-Green	3
4	Blue		Blue	4
5	White/Blue		White/Blue	5
6	Green		Green	6
7	White/Brown		White/Brown	7
8	Brown		Brown	8

**Figure 6: Cross-over cable**

1	White/Orange			White/Orange	1
2	Orange			Orange	2
3	White-Green			White-Green	3
4	Blue			Blue	4
5	White/Blue			White/Blue	5
6	Green			Green	6
7	White/Brown			White/Brown	7
8	Brown			Brown	8

Please make sure your connected cables have the same pin assignment and color as above before deploying the cables in your network.





