

OPERATING INSTRUCTIONS



IP30



IP65

AR207

DATA RECORDER



Thank you for choosing our product. These instructions will facilitate operating the device and enable safe use of the controller at its full capacity. Prior to the installation and startup of the device, please become familiar with these instructions. In the event of any additional questions, please contact our technical adviser.

CONTENTS

- 1. SAFETY PRINCIPLES 3
- 2. INSTALLATION GUIDELINES..... 3
- 3. GENERAL CHARACTERISTICS OF THE MULTI-CHANNEL RECORDER 4
- 4. CONTENTS OF THE SET..... 5
- 5. TECHNICAL DATA 5
- 6. ENCLOSURE DIMENSIONS AND INSTALLATION DATA..... 7
- 7. DESCRIPTION OF TERMINAL STRIPS AND ELECTRICAL CONNECTIONS 7
- 8. CONNECTING TO A COMPUTER AND INSTALLATION OF USB DRIVERS..... 9
- 9. INSTALLATION OF SOFTWARE 10
- 10. FUNCTIONS OF HARDWARE AND SCREEN BUTTONS 10
- 11. DESCRIPTION OF DATA PRESENTATION ON THE LCD DISPLAY 12
 - 11.1. UPPER AND LOWER STATUS BAR..... 12
 - 11.2. VIEW OF A MEASUREMENT GROUP (TEXT ONLY) 13
 - 11.3. VIEW OF A MEASUREMENT GROUP (TEXT AND A BAR GRAPH)..... 13
 - 11.4. VIEW OF A MEASUREMENT GROUP (ANALOG INDICATOR)..... 14
 - 11.5. SINGLE MEASUREMENT (CHART)..... 14
- 12. SETTING PARAMETERS AND OPERATIONS ON FILES (MAIN MENU) 14
 - 12.1. MEANING OF ICONS IN THE MENU ITEMS..... 16
 - 12.2. RECORDING SETTINGS..... 16
 - 12.3. MEMORY OPTIONS AND OPERATIONS ON FILES..... 17
 - 12.4. UNIVERSAL AND ANALOG MEASUREMENT INPUTS CONFIGURATION..... 18
 - 12.5. PULSE MEASUREMENT INPUTS CONFIGURATION 18
 - 12.6. CONFIGURATION OF ALARM OUTPUTS..... 21
 - 12.6.1. E-MAIL ALARM NOTIFICATIONS..... 22
 - 12.7. DISPLAY SETTINGS..... 23
 - 12.8. SERIAL RS485, USB, AND ETHERNET COMMUNICATION SETTINGS 23
 - 12.8.1. DYNAMIC DNS (DDNS) SERVER CLIENT..... 25
 - 12.9. ACCESS AND OTHER SETTINGS 26
 - 12.10. DATE AND TIME..... 26

12.11. DEVICE INFORMATION.....	27
13. USE AND FUNCTIONS OF USB MEMORY (PENDRIVE)	27
14. VIEWING RECORDED MEASUREMENTS AND EVENTS	27
15. MESSAGE AND ERROR SIGNALING	28
16. IMPORTANT COMMENTS PERTAINING TO OPERATION	28
17. RS485 COMMUNICATION INTERFACE (acc. to EIA RS-485)	29
18. MODBUS–RTU SERIAL TRANSMISSION PROTOCOL (SLAVE)	29
19. MODBUS–TCP SERIAL TRANSMISSION PROTOCOL.....	30
20. MAP OF DEVICE REGISTERS FOR THE MODBUS-RTU/TCP	30
21. USER'S NOTES	32



Please pay particular attention to the text marked with this sign.

The manufacturer reserves the right to make changes to the design and the programming of the device without any deterioration of the technical parameters (some features may not be available in older versions)

1. SAFETY PRINCIPLES



Before you start to use the device, become familiar with the present instructions.

- a) in order to avoid electrocution or damage to the device, its mechanical and electrical installation must be performed by qualified staff;
- b) before switching on the power supply, make sure that all cables and wires are properly connected;
- c) before making any modifications to the wire and cable connections, switch off the power supply of the device;
- d) ensure proper operating conditions compliant with the technical specification of the device (chapter 5, power supply voltage, humidity, temperature, etc.); do not expose the device to direct and strong impact of thermal radiation.

2. INSTALLATION GUIDELINES



The device is designed so as to ensure an appropriate level of immunity to most interferences that may occur in industrial and household environments. In environments of unknown level of interferences, it is recommended to implement the following measures so as to prevent potential interference with the operation of the device:

- a) do not supply the device from the same lines as high-power equipment without using appropriate power line filters;
- b) use cable shields on power supply cables, sensor cables, and signal cables, whereby the earthing of the shield should be single-point and located as close to the device as possible;
- c) avoid running instrument (signal) cables in the direct vicinity of and parallel to power distribution and power supply cables;
- d) it is recommended to twist the signal wires in pairs or to use a finished twisted-pair cable;
- e) in the case of sensing resistors in 3-wire connections, use identical wires;
- f) avoid locating remotely controlled, electromagnetic meters, and high-power loads, loads with phase or group power control, and other devices producing large impulse interferences close to one another;
- g) ground or zero metal rails on which rail-mounted devices are installed.

Make sure to remove the protective film from the LCD display before the first use of the device.

3. GENERAL CHARACTERISTICS OF THE MULTI-CHANNEL RECORDER

- measurement and recording of temperature from thermoresistance sensors and thermocouples and other physical values (humidity, pressure, level, flow, speed, etc.) processed to a standard electrical signal (0/4÷20mA, 0÷10V, 0÷60mV, 0÷850Ω)
- 16 analog measurement inputs (mA, V) or 8 universal inputs (thermoresistance, thermocouple and analog) or 8 pulse inputs or 8 mixed inputs (4 universal and 4 pulse), not galvanically insulated
- 4 alarm/regulation outputs with sound and visual operating status signaling and e-mail notifications, programmable characteristics, and the possibility to assign any measurement channels that trip the alarm
- saving data in standard text files stored in the recorder's internal memory (4 GB) or in a USB memory in the FAT system with possible edition in spreadsheets in such software as Microsoft Excel and OpenOffice Calc
- rich standard equipment with serial interfaces: USB (cooperation with a computer and USB memories), RS485 and Ethernet (100base-T, TCP/IP protocols), MODBUS-RTU and MODBUS-TCP
- a web server for cooperation with any web browser (Opera, IE, Firefox, etc.), the site contains information on active measurement channels, time, status of outputs, recording, etc., with the possibility to present charts using the Google Chart API service (permanent Internet access is required to present charts)
- the DDNS service, which enables easy access over the Internet a recorder connected to a network that has no fixed public IP address, through a friendly Internet address defined by the user; the service is available only for registered users of popular DDNS services, such as DynDNS (www.dyndns.org), No-IP (www.no-ip.com), and DNS-O-Matic (www.dnsomatic.com)
- possibility to transfer archive data and configuration data onto a USB memory using a USB port of the computer or over the Ethernet
- a color graphic display, LCD TFT, 320x240 points (QVGA) with a touch screen, brightness adjustment, and programmable background color for individual measurement channels
- intuitive use, quick configuration, and clear signaling of device operating statuses and menu position
- a programmable language of the menu (Polish, English), which also covers the version of the site saved on the web server
- graphic and text methods of presentation of the measured values (numerical values, bar graph, counter, graph)
- grouping of measurement channels to be displayed, with automatic formatting of the screen
- programmable F button for quick selection of one of the available functions: stop/start of recording, copying or transfer of archives into USB memory, blocking of outputs, sound alarms or touch screen and keypad, device and internet services status
- a broad selection of methods of initiation of recording (continuous, limited by date and time, repeated daily, over or under a permission threshold connected with any measurement channel)
- internal real time clock with a battery backup power supply (up to 8 years of continuous operation)
- an integrated 24 V DC power supply supplying the field transducers;
- compensation of line resistance for resistance sensors (automatic or permanent)
- compensation of thermocouple cold tip temperature (automatic or permanent)
- enclosed free software enabling graphic or text presentation of recorded result (ARSOFT-WZ3) and configuration of parameters (ARSOFT-WZ1)
- programmable types of inputs, ranges of indications, alphanumeric description of channels and measurement groups, options of recording, alarms, display, communication, access, and other configuration parameters
- access to configuration parameters protected with a user password or not protected with a password
- parameter configuration methods:
 - from the film keypad and a touch screen located on the front panel of the device
 - via the USB, the RS485, or the Ethernet and the ARSOFT-WZ1 free software (Windows 2000/XP/Vista/7/8) or a user's application, the MODBUS-RTU and MODBUS-TCP communication protocols
 - from configuration files saved in the USB memory or on a computer disk
- available protection of measurement data from unauthorized modification (check sum)
- possibility to distinguish archives from many recorders of the same time thanks to individual assignment of an

identification number (ID)

- clearly visible status of operation of recording, memory, USB port, alarms, file and disk operations, serial transmission (USB, RS485, Ethernet), etc.
- recording of data until the memory is full (at least 300 days of continuous operation with recording of 16 channels every 1 s)
- simultaneous recording of data from all active measurement inputs
- enclosure for panel installation, leak-tightness from the front side IP65 or IP30 (depending on the version)
- high accuracy and immunity to interferences
- possibility to latest firmware upgrade via USB memory
- available accessories:
 - a USB memory (2 or 4 GB)

NOTE:



- **before starting to work with the recorder, you must become familiar with these operating instructions, properly prepare the electrical system and the mechanical system, and correctly configure the parameters**
- **do not use sharp-edged objects to work with the touch screen**

4. CONTENTS OF THE SET

- the recorder
- a USB cable for connecting the device to a computer, 2 m long
- a CD with the drivers and the software (Windows 2000/XP/Vista/7/8)
- the operating instructions and the warranty card

5. TECHNICAL DATA

Number of measurement inputs	16 analog or 8 universal/pulse inputs, not galvanically isolated		
Universal inputs (programmable, 16 types), measurement ranges (1)			
- Pt100 (RTD, 3- or 2-wire)	-200 ÷ 850 °C	- thermocouple R (TC, PtRh13-Pt)	-40 ÷ 1600 °C
- Ni100 (RTD, 3- or 2-wire)	-50 ÷ 170 °C	- thermocouple T (TC, Cu-CuNi)	-25 ÷ 350 °C
- Pt500 (RTD, 3- or 2-wire)	-200 ÷ 620 °C	- thermocouple E (TC, NiCr-CuNi)	-25 ÷ 850 °C
- Pt1000 (RTD, 3- or 2-wire)	-200 ÷ 620 °C	- thermocouple N (TC, NiCrSi-NiSi)	-35 ÷ 1300 °C
- thermocouple J (TC, Fe-CuNi)	-40 ÷ 800 °C	- current (mA, R _{in} = 100 Ω)	0/4 ÷ 20 mA
- thermocouple K (TC, NiCr-NiAl)	-40 ÷ 1200 °C	- voltage (V, R _{in} = 180 kΩ)	0 ÷ 10 V
- thermocouple S (TC, PtRh10-Pt)	-40 ÷ 1600 °C	- voltage (mV, R _{in} > 2 MΩ)	0 ÷ 60 mV
- thermocouple B (TC, PtRh30PtRh6)	300 ÷ 1800 °C	- resistance (R, 3-wire or 2-wire)	0 ÷ 850 Ω
Current analog input (mA, programmable, 2 types)		0/4 ÷ 20 mA (R _{in} = 100 Ω) (2)	
Voltage analog input (V, programmable, 2 types)		0/2 ÷ 10 V (R _{in} = 200 kΩ) (2)	
Response time (10 ÷ 90%)		1 ÷ 5 s (programmable)	
Resistance of leads (RTD, R)		R _d < 25 Ω (for each line), compensation of resistance	
Resistance input current (RTD, R)		650 μA (Pt100, Ni100, 850Ω), 150 μA (Pt500, Pt1000), multiplexed	
Pulse inputs	Supported sensor output	- open collector NPN type	
		- open collector PNP type	
		- contact (reed)	
	Frequency range	0.035Hz ÷ 10kHz (3)	
Voltage input levels (for pulse inputs „IN” and auxiliary inputs „R”)	high level	0 ÷ 0.7 V (±0.1V) and 13 ÷ 24V (±0.1V)	
	Low level	0.8 ÷ 13 V (±0.1V)	

	Minimum duration of low/high level		25 μ s (3)
Processing errors (at ambient temperature of 25 °C):			
- basic	- for RTD, mA, V, mV, R		$\leq 0.1\%$ of the measurement range ± 1 digit
	- for thermocouples (TC)		$\leq 0.2\%$ of the measurement range ± 1 digit
	- for pulse inputs		$\leq 0.05\% \pm 1$ digit
- additional for thermocouples			≤ 2 °C (compensation of temperature of cold tips)
- additional from ambient temperature changes			$\leq 0.005\%$ of the input range /°C
Range of indications (resolution of analog inputs)			-9999 ÷ 99999, programmable
			0 ÷ 99999 (4)
Resolution of indications/position of the decimal point			programmable, for thermometric inputs 0.1°C or 1 °C, for other inputs 0 ÷ 0.000
Real time clock (RTC) (backup supply: CR1220 lithium battery)			quartz, date, time, takes leap years into account)
Communication interfaces	- USB (A4 socket type, IP30 version also accessible from the front, programmable mode of operation)	- slave mode (device)	communication with a computer, drivers for the Windows 2000/XP/Vista/7/8 system: exchangeable disk (mass memory, readout speed approx. 335kB/s) + virtual COM serial port (MODBUS-RTU protocol)
		- master mode (host)	support of USB memory (pendrive) up to 4 GB, writing speed approx. 135kB/s (depending on the type of the memory)
	- RS485 (MODBUS-RTU protocol, SLAVE)		speed 2.4÷115.2 kbit/s, sign format 8N1, galvanic separation
	- Ethernet (type 100base-T, RJ45 socket)		web server, MODBUS-TCP, e-mail client (SMTP), DDNS server client, TCP/IP protocols: DHCP (client, server), SMTP, NetBIOS, ICMP, UDP, TCP, data transfer up to 135 kB/s (depending on the network)
Data recording interval			programmable 1 s to 8 hours (5)
Data storage memory (non-volatile, recording of approx. 27 million measurements from 16 channels and 4 GB memory):			
- internal (micro SDHC card, industrial, MLC)		4 GB, FAT32 file system	
- external USB memory (pendrive, A4 type socket)		FAT16, FAT32, maximum size 4 GB	
Outputs (4 independent)	- relay		5A / 250VAC (for resistance loads), SPST
	- SSR (transistor, type NPN OC, optional)		24V, internal resistance 850 Ω
Display (LCD TFT, 320x240 points - QVGA)			3.5" (diagonal), background brightness adjustment
Power supply:	- 230 VAC		85 ÷ 260 VAC/ 7 VA
	- 24 VAC/DC (option)		20 ÷ 50 VAC/ 7 VA, 22 ÷ 72 VDC/ 7 W
Power supply of field transducers			24 VDC / 200 mA (100 mA in the case of the 24 VAC/DC supply)
Rated operating conditions			0 ÷ 50 °C, <100% RH (no condensation)
Operating environment			air and neutral gases, no dust
Protection rating			IP65 or IP30 from the front, IP20 from the side of the connections
Weight			approx. 420 g
Electromagnetic compatibility (EMC)			immunity: according to the PN-EN 61000-6-2:2002(U) standard
			emissivity: according to the PN-EN 61000-6-4:2002(U) standard

Notes: (1) - applies only to the recorder version with universal inputs
(2) - applies only to the recorder version with analog inputs (current or voltage)
(3) - for simultaneously measured flow and flow balance from the same sensor: 50 μ s (5kHz) or 100 μ s (2,5kHz)
(details in chapter 12.5. PULSE MEASUREMENT INPUTS CONFIGURATION)

(4) - applies only to the recorder version with pulse inputs

(5) - in the case of recording interval of 1 s, the recording may be uneven during the transfer of the archive over the Ethernet and also due to the excessive number of files, their size, and the type and brand of the USB (pendrive) memory used

6. ENCLOSURE DIMENSIONS AND INSTALLATION DATA

Enclosure type	panel, Incabox XT L57	
Material	self-extinguishing NORYL 94V-0, polycarbonate	
Enclosure dimensions	96 x 96 x 79 mm	
Panel window	92 x 89 mm	
Fixing methods	grips on the side of the enclosure	
Conductor cross-sections (separable connectors)	2.5 mm ² (supply and alarm outputs), 1.5 mm ² (others)	

7. DESCRIPTION OF TERMINAL STRIPS AND ELECTRICAL CONNECTIONS

Location, numbering, and description of the connections on the back panel and method of connecting sensors and measurement signals:

a) measurement connections in the version with universal inputs, AR207/8 (RTD, TC, mA, V, mV, R), INPUT1÷INPUT8, parameters configuration described in chapter 12.4

21	22	23	24	25	26	27	28	29	30	31	32	33	34	35	36	37	38	39	40
IN1	IN2	IN3	GND	+24 V	IN1	IN2	IN3	GND	+24 V	IN1	IN2	IN3	GND	+24 V	IN1	IN2	IN3	GND	+24 V
INPUT 5				INPUT 6				INPUT 7				INPUT 8							
1	2	3	4	5	6	7	8	9	10	11	12	13	14	15	16	17	18	19	20
IN1	IN2	IN3	GND	+24 V	IN1	IN2	IN3	GND	+24 V	IN1	IN2	IN3	GND	+24 V	IN1	IN2	IN3	GND	+24 V
INPUT 1				INPUT 2				INPUT 3				INPUT 4							

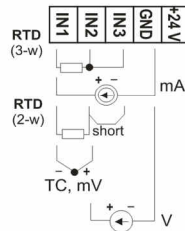

Terminal clamps (connections)	Description
IN1-IN2-IN3	RTD and R (Pt100, Pt500, Pt1000, Ni100, 850Ω) inputs, in a 2- and 3-wire connection
IN1-IN2	thermocouple input TC (J, K, S, B, R, T, E, N) and voltage input 0÷60 mV
IN1-GND	current input 0/4÷20 mA
IN2-GND	voltage input 0÷10 V
+24 V	output +24 V (in relation to the GND) of the integrated power supply of field transducers

a.1) connection of the 2- and 3-wire transducer (I_{out} – output current, U_{out} – output voltage)

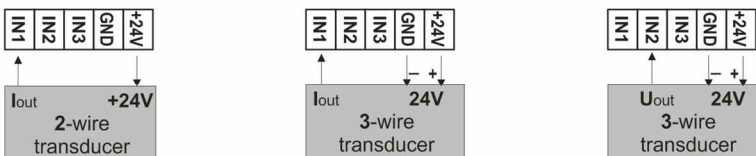

b) measurement connections in the version with analog inputs (mA or V), IN1÷IN16, parameters configuration described in chapter 12.4

21	22	23	24	25	26	27	28	29	30	31	32	33	34	35	36	37	38	39	40
IN	GND			GND			IN	GND		IN	GND			GND			IN	GND	
IN9	IN10	IN11	IN12	+24V						IN13	IN14	IN15	IN16	+24V					
1	2	3	4	5	6	7	8	9	10	11	12	13	14	15	16	17	18	19	20
IN	GND			GND			IN	GND		IN	GND			GND			IN	GND	
IN1	IN2	IN3	IN4	+24V						IN5	IN6	IN7	IN8	+24V					

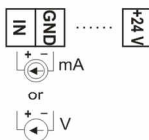

Terminal clamps (connections)	Description
IN-GND	current output 0/4÷20 mA or voltage output 0/2÷10 V
+24 V	output +24 V (in relation to the GND) of the integrated power supply of field transducers

b.1) connection of the 2- and 3-wire transducer (I_{out} – output current, U_{out} – output voltage)

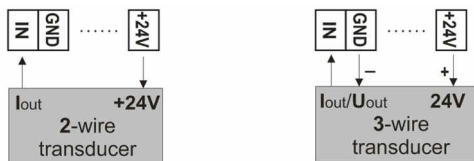

c) measurement connections in the version with pulse inputs, AR207/8P, WEJŚCIE1÷WEJŚCIE8, parameters configuration described in chapter 12.5

21	22	23	24	25	26	27	28	29	30	31	32	33	34	35	36	37	38	39	40
GND		IN	+24V	R	GND			GND	R	GND		IN	+24V	R	GND			IN	R
WEJŚCIE 5					WEJŚCIE 6					WEJŚCIE 7					WEJŚCIE 8				
1	2	3	4	5	6	7	8	9	10	11	12	13	14	15	16	17	18	19	20
GND		IN	+24V	R	GND			GND	R	GND		IN	+24V	R	GND			IN	R
WEJŚCIE 1					WEJŚCIE 2					WEJŚCIE 3					WEJŚCIE 4				

Terminal clamps (connections)	Description
GND	ground for measured inputs and for power supply 24V
IN	pulse input 0.035Hz ÷ 10kHz
+24V	output +24 V (in relation to the GND) of the integrated power supply of field transducers
R	auxiliary input

c.1) connections for flow meters with open collector NPN or PNP type and with contact output

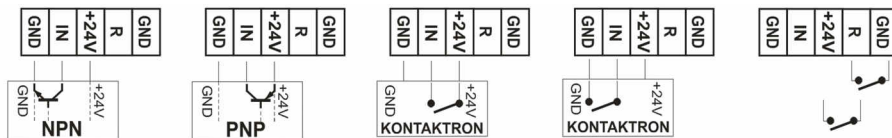

d) measurement connections in the version with 4 universal inputs and 4 pulse inputs (AR207/4P4), parameters configuration described in chapter 12.4 and 12.5

- INPUT1 ÷ INPUT4 (bottom universal inputs module) according to point **7.a)** above
- INPUT5 ÷ INPUT8 (top pulse inputs module) according to point **7.c)** above

e) other connections

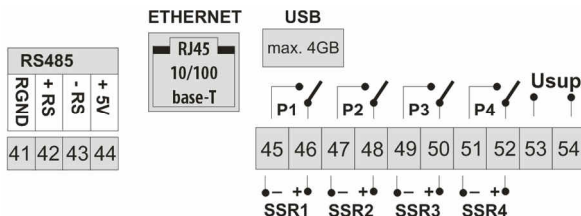

NOTE: In the IP30 version, the USB connection is also available on the front panel.

DO NOT USE SIMULTANEOUSLY WITH THE BACK CONNECTION!

Terminal clamps (connections)	Description
41÷44	RS485 serial interface (MODBUS-RTU transmission protocol)
45÷52	relay outputs P1, P2, P3, and P4 or SSR1, SSR2, SSR3, and SSR4
53-54	power supply input 230 VAC or 24 VAC/DC
ETHERNET	serial Ethernet interface (type 100base-T, RJ45 socket, TCP/IP protocols)
USB	serial USB interface (programmable operation mode: device or host, chapter 12.8, in the IP30 version, do not use two USB sockets at the same time)

8. CONNECTING TO A COMPUTER AND INSTALLATION OF USB DRIVERS

Connecting the recorder to a USB port of a computer may be useful in order to configure the names of channels, groups, measurement units, and other parameters of the device, and to download files with recorded data. The available support software is described further in the present instructions.

Before connecting the cable to the USB port of a computer, make sure that the **USB operation mode** parameter is set to **Available for a computer** (chapter 12.8, **Communication settings** menu). After you connect for the first time, the Windows (2000/XP/Vista/7/8) system detects the recorder named "**Apar Composite Device**" and demands installation of drivers of the virtual COM serial port (MODBUS-RTU protocol, also used by the ARSOFT-WZ1 software). In the device manager or the new device wizard, **manually** indicate the location of the drivers (the CD-ROM, the **DRIVERS** folder, or the drivers downloaded from the www.apar.pl website).

Always skip automatic downloading of the driver software from the Windows Update website.

In the Windows 7 system, from the **Device Manager** level, the installation is performed in the following manner:

1. Right-click the "**Apar Composite Device**" position and select the "**Update Driver Software...**" option, and then the "**Browse my computer for driver software**" option.
2. Use the "**Browse...**" button to indicate the location on the disk (the **DRIVERS** folder) where the drivers are and click the "**Continue**" button.
3. The virtual COM port "**USB Serial Port**" is installed; press the "**Finish**" button.

4. Additionally, in the "**Disc drives**" branch, the system detects and installs the "**Microchip Mass Storage USB Device**." After the installation is completed, the recorder is listed in the system as an exchangeable 4 GB disk with the label **AR207** and a virtual COMx serial port (x - port number: 1, 2, etc.). The serial port uses the MODBUS-RTU protocol. In the internal memory two configuration text files are shown: **AR207.cfg** and **AR207.txt** (chapter 12).

Communication with the device can also be established using the Ethernet and the RS485 interfaces, which are a part of the recorder's standard equipment and do not require installation of additional drives. However, if an RS485 converter for USB is used in the computer, it is necessary to install the serial port drivers provided by the manufacturer.

NOTE:



- do not disconnect the device from the computer before completion of installation of the drivers
- when the recorder is connected to the USB port of a computer, recording is stopped until the cable is disconnected and the file operations accessible from the menu level and the transmission of files with the measurement data via the Ethernet from the ARSOFT-WZ3 is stopped

9. INSTALLATION OF SOFTWARE

In the "**SOFTWARE**" folder of the CD-ROM that is provided with the device there is a free software installation set for the recorder. The installation set comprises the following applications (for Windows 2000/XP/Vista/7/8):

Name	Software description
ARSOFT-WZ1	<ul style="list-style-type: none"> - display of current measurement data, as well as the date and the time, configuration of the real time clock (RTC) and of other parameters, such as types of measurement inputs, names of measurement channels, units, and groups, ranges of indications, recording alarms, display, communication, access and other options (chapter 12), - creation of a disk with a ".cfg" extension, containing the current configuration of the parameters to be used again (duplication of configuration), - the program requires communication with the recorder via the USB, RS485 or Ethernet port (on-line configuration)
ARSOFT-WZ3	<p>graphic or text presentation of the recorded results with printing option; the input data is collected at one time from a text file with a ".scv" extension, created in the recorder in the internal memory or in the USB memory (chapter 14); the data can also be collected via the Ethernet network.</p>

The latest versions of the aforementioned programs are also available at the website (www.apar.pl, Download tab). The detailed descriptions of the aforementioned applications can be found in the installation folders.

10. FUNCTIONS OF HARDWARE AND SCREEN BUTTONS

Fig. 10. Description of the front panel using the example of the version with IP65 rating (the IP30 version has an additional USB socket on the front)

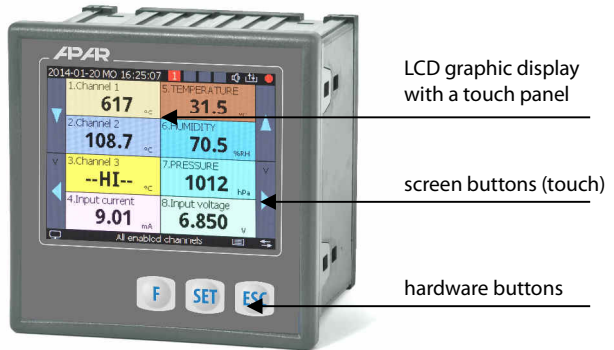





NOTE:



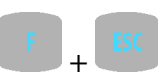

Do not use sharp-edged objects to work with the screen buttons and other screen objects

a) button functions in the measurement display mode (chapter 11)

Button	Description [and marking in the contents of the instructions]
	[SET] , hardware button: - input in the parameter configuration and file operations menu. If Password protection in the Access and other settings is on, then enter the password, chapter 12.9 - closing the message window appearing on the screen (chapter 15)
	[UP] or [DOWN] , screen buttons: change of the displayed measurement group or a single measurement channel in the CHART presentation mode
	[LEFT] or [RIGHT] , screen buttons: change of the measurement data presentation mode (TEXT, BAR GRAPH, ANALOG INDICATOR, CHART, chapter 11)
	[F] , hardware button: activation of a function programmed with a parameter F button function (chapter 12.9), active only in the measurement presentation mode, sub-item c
	[ESC] , hardware button: closing the message window appearing on the screen (chapter 15)
	[F] and [ESC] (simultaneously): Device status screen (hardware informations, parameters of the Ethernet interface and Internet services, current record number in the archive file csv, etc.), function is also available from [F] button (point c and chapter 12.9)

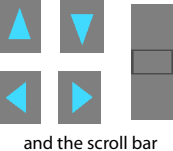
b) functions of the buttons in the parameter configuration and file operations mode (**Main Menu**, chapter 12)

Button	Description
	- selects the marked item in the menu (entering a lower menu level or edition of a parameter), action accessible also from the touch screen level - approves the edited parameter value (it is saved in the non-volatile internal memory after the user exits the <i>Main Menu</i> or disconnects the device from the computer's USB port) - closes the message window appearing on the screen (chapter 15)
 and the scroll bar	[UP] or [DOWN] and the screen scroll bar: - moves to the next or previous item in the menu - changes the value of the edited parameter (also [LEFT] or [RIGHT])
	- returns to the previous menu (higher level) - cancels the changes to the edited parameter - exits the Main Menu and returns to the measurement presentation mode - closes the message window appearing on the screen (chapter 15)

c) meaning of the function button **[F]** (active only in the measurement presentation mode)

Button	Description (depending on the value of the F button function parameter in the Access and other settings menu, chapter 12.9)	Status signaling /icon
	Device status - device status screen (factory setting, function available also via simultaneously pressed buttons [F] and [ESC] , described at point a, above)	screen
	Stop/Start of recording - change of the Recording type parameter to Off or Continuous (chapter 12.2), after the power supply is switched on, the recording is always on (continuous)	● or none
	Copy archives to the USB memory (operation accessible also in the Memory and files options menu, chapter 12.3)	messages

Move archives to the USB memory - the files in the recorder are deleted after they have been copied	messages
Disable/Enable sound alarm - change of the Alarm sound signal parameter to Disabled or Enabled (chapter 12.6, Outputs (alarm) configuration menu), after the power supply has been switched on, the sound signaling of all alarm is always on	🔊 or none
Block/Unblock all alarms – after the power supply has been switched on, all alarm outputs are always in operation in accordance with the programmed characteristics (chapter 12.6)	🔇 or none
Touch panel lock – display touch panel and hardware buttons lock (except [F])	🔒 or none

11. DESCRIPTION OF DATA PRESENTATION ON THE LCD DISPLAY

The recorder enables presentation of the measurement data in various modes in accordance with the following diagram:

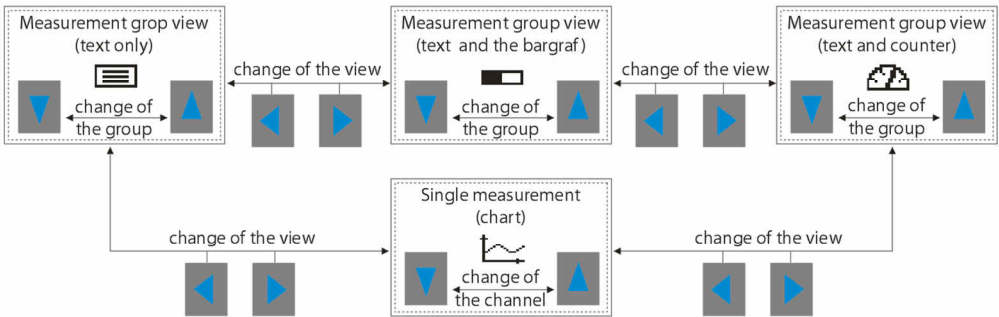

Fig. 11. Block diagram of the available measurement data presentation modes (the detailed descriptions are provided in the chapters below)

If the number of channels in a group exceeds the maximum value that enables presentation of all the graphic element of a given view on the screen, the view is automatically switched to the text mode.

11.1. UPPER AND LOWER STATUS BAR

The status bars can be seen in the upper and lower part of the display only in the measurement presentation modes. The meaning of the individual graphic elements is described below.

a) upper status bar



Fig. 11.1.1. Upper status bar

Object	Description [and marking in the contents of the instructions]
1	date (yyyy-mm-dd), day of the week and time (hh:mm:ss) on the real time clock (RTC, chapter 12.10)
2	status of alarm outputs, from the 1st to the 4th (chapter 12.6, Outputs (alarm) configuration menu) gray - the output is switched off (the alarm is inactive); red (with the numbers of the input channels that activate the alarm) - the output is switched on
3	🔊 parameter Alarm sound signal is set to the Enabled value (chapter 12.6) 🔇 all the alarm outputs blocked with the programmable [F] button (chapters 8 and 12.9)
4	[R/W] - signaling of writing to or reading from the internal memory or the USB memory
5	📁 signaling of ongoing recording in the internal memory or the USB memory (📁)

b) lower status bar



Fig. 11.1.2. Lower status bar

Object	Description [and marking in the contents of the instructions]			
6		no USB connection with the computer	the USB port is accessible for the computer (device)	signaling of the operation mode and the status of the USB port (chapter 12.8, Table 12.8, USB operation mode parameter)
		the USB port is connected to the computer		
		no USB memory, do not connect to the computer!	USB memory support (host), chapter 13	
		USB memory (pendrive) was detected		
7	measurement group name (up to 16 characters per group, taken from the AR207.txt file, chapter 12.4, 12.5)			
8		view of a measurement group (text only)	signaling of measurement data presentation mode (type of view)	
		view of a measurement group (text and a bar graph)		
		view of a measurement group (text and an analog indicator)		
	none	a single measurement (chart)		
9	[Tx/Rx] - signaling of presence of serial transmission (via the RS485, a USB port or the Ethernet)			
10	display touch panel and hardware buttons lock (one of [F] button functions), chapter 12.9			

11.2. VIEW OF A MEASUREMENT GROUP (TEXT ONLY)

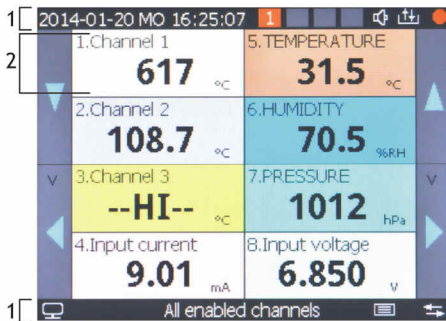

Object	Description
1	status bars (chapter 11.1)
2	measurement panel: number, name (up to 16 characters) and unit (up to 4 characters) of the measurement channel (name and unit taken from the AR207.txt file, chapter 12.4, 12.5), measured value with signaling of exceeded measurement range (chapters 12.4, 12.5 and 15)

Fig. 11.2. Appearance of the measurement group screen in the TEXT ONLY mode (possibility to present max. 16 channels)

11.3. VIEW OF A MEASUREMENT GROUP (TEXT AND A BAR GRAPH)

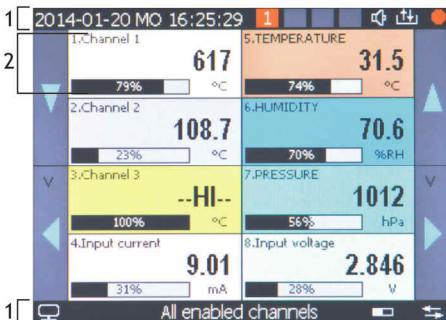

Object	Description
1	status bars (chapter 11.1)
2	measurement panel: number, name, measured value, and unit of the measurement channel (chapter 11.2), graphic presentation of the measurement (bar graph) works in the range set by the parameters Bottom of the indication range and Top of the indication range (chapter 12.4, 12.5)

Fig. 11.3. Appearance of the measurement group screen in the TEXT AND A BAR GRAPH mode (presentation max. 8 chan.)

11.4. VIEW OF A MEASUREMENT GROUP (ANALOG INDICATOR)

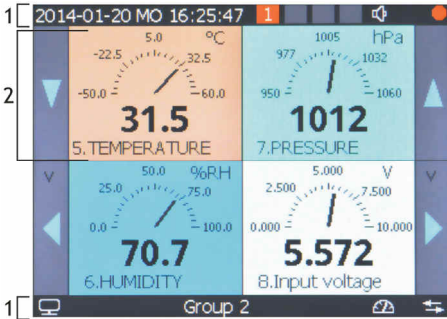

Object	Description
1	status bars (chapter 11.1)
2	measurement panel: number, name, measured value, and unit of the measurement channel (chapter 11.2), graphic presentation of the measurement (analog indicator) works in the range set by the parameters Bottom of the indication range and Top of the indication range (chapter 12.4, 12.5)

Fig. 11.4. Appearance of a single screen in the ANALOG INDICATOR (counter) mode (presentation maximum 6 channels)

11.5. SINGLE MEASUREMENT (CHART)

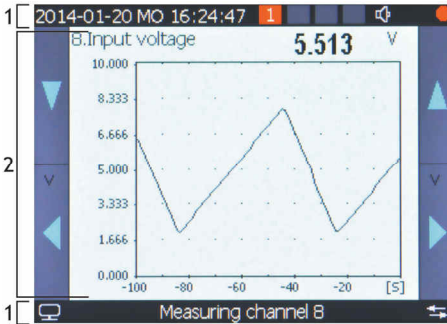

Object	Description
1	status bars (chapter 11.1)
2	measurement panel: number, name, measured value, and unit of the measurement channel (chapter 11.2), graphic presentation of the measurement (chart) works in the range set by the parameters Bottom of the indication range , Top of the indication range (chapter 12.4, 12.5), and Chart time range (chapter 12.7)

Fig. 11.5. Appearance of a single screen in the CHART mode

12. SETTING PARAMETERS AND OPERATIONS ON FILES (MAIN MENU)

All the configuration parameters and names of channels and groups, as well as measurement units of the recorder are stored in the non-volatile internal memory in two text files: *AR207.cfg* (parameters) and *AR207.txt* (names and units - changes can be implemented only using a computer in the ARSOFT-WZ1 software via the USB port or the Ethernet, as well as in any text editor, e.g. Windows Notebook).

When the device is switched on for the first time, an error message may be shown in the display due to the lack of a sensor or the fact that the sensor that is connected is not one that is factory-programmed. In such a situation, the proper sensor or analog signal must be connected and the configuration must be programmed.

As a standard, the parameter configuration can be performed using one of the following three methods (**do not use them at the same time**):

1. From the film keypad and a touch screen located on the front panel of the device:

- from the mode where the input measurements are displayed in the **Main Menu** ([SET] button). If **Password protection** in the **Access and other settings** is on, enter the password, the factory-set password is **1111**, chapter 12.9.

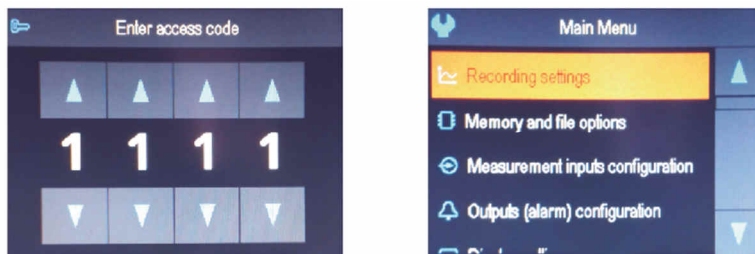

Fig. 12. Appearance of the password screen and the **Main Menu**

- use buttons **[UP]** or **[DOWN]**, or the scroll bar to select an appropriate sub-menu or parameter to be changed/viewed
- use the **[SET]** button or touch the selected item in the menu (also in order to edit the parameter)
- use the **[UP]**, **[DOWN]**, **[LEFT]**, or **[RIGHT]** button or the scroll bar to change the value of the edited parameter
- approve the changed value of the parameter by pressing the **[SET]** button or cancel it by pressing the **[ESC]** button

2. Use the USB or RS485 port, or the Ethernet and the ARSOFT-WZ1 software (on-line configuration):

- connect the recorder to a computer port and start and configure the ARSOFT-WZ1 application
- after the connection has been established, the current measured values and the internal time and date of the recorder are displayed in the software window; the icon **[Tx/Rx]** indicates presence of transmission (lower status bar, chapter 11.1)
- setting and viewing of the device parameters is possible in the parameter configuration window
- new parameter values must be approved with the **Approve changes** button
- the software enables synchronization of the time and the date with the computer
- the current configuration can be saved in a file on the disk or set using values read from a file
- **the recorder updates** the configuration files and **the displayed names after it is disconnected from the computer's USB port**
- on-line configuration via the USB port is possible only when the **USB operation mode** is set at **Available for a computer (device)**, chapter 12.8.

NOTE: 

- before disconnecting the device from a computer, press the **Disconnect device** button
- in the event of no response:
 - in the **Program options** check the configuration of the port and the **MODBUS Address of the device** (in the case of the RS485)
 - make sure that the serial port drivers have been installed correctly (chapter 8)
 - disconnect for a few seconds and then reconnect the recorder to the USB port
 - restart the computer

3. From the configuration file created in the ARSOFT-WZ1 software or copied from another recorder of the same type in order to duplicate the configuration, off-line configuration:

- in ARSOFT-WZ1 set the required parameters (except for the **RTC** and the identification number **ID**)
- a current configuration can also be prepared by modifying the values read from the existing files
- save the created configuration in an *AR207.cfg* or *AR207.txt* file and save it on a USB memory
- in the **Memory and file options** of the recorder, import the configuration from the USB memory, chapter 12.3
- after the configuration has been completed, the memory can be disconnected from the USB socket

As an alternative to the configuration methods described above, the user can prepare his own application using the available serial interfaces and the MODBUS-RTU or MODBUS-TCP communication protocol.

In the event of indications different than the actual value of the input signal, the zero and the sensitivity of a sensor can be adjusted in the **Measurement inputs configuration** menu: the **Offset calibration** and the **Slope calibration** (sensitivity) parameters, chapter 12.4, 12.5.



NOTE: 

Do not shut down the power supply during the configuration performed using the keypad or on-line (via the computer's USB port) because the changed parameter values are stored in the internal memory after the user exits the **Main Menu** (by pressing the **[ESC]** button) or disconnects the device from the USB socket.

12.1. MEANING OF ICONS IN THE MENU ITEMS

In order to improve the ease of use and configuration of the device, additional graphic descriptive elements were added to the menu in the form of icons (pictograms).







The shared meaning of some icons described the type of menu item is the following:

Icon	Type of menu item (parameter)
	parameter that can be modified using the buttons and the touch screen, saved in the internal memory
	informative item, not modified directly using the buttons and the touch screen
	file or disk action (operation) (chapter 12.3)

12.2. RECORDING SETTINGS

Data is archived in a text file with a csv extension in the internal memory or the USB memory; a detailed description of the storage format is given in chapter 14. Data is recorded until the memory is full (at least 300 days of continuous operation with recording from 16 channels every 1 s) and then the recording is stopped and the message "Memory full. Recording rejected" is displayed repeatedly (chapter 15). The recording must then be stopped (the **Recording type** must be set to the **Off** value, Table 12.2), the archive files must be copied for further analysis, and space must be freed up in the memory for future recordings. The selection of the memory for recording and the copying and deleting of existing csv files are accessible in the **Main Menu -> Memory and file options**, a detailed description of operations performed on files is given in chapter 12.3. The data recording interval must be adjusted according to the needs of a specific application.

Table 12.2. Configuration parameters in the **Recording settings** menu









Parameter 	Range of variability of the parameter and description		Factory settings
Data recording interval	1 s to 8 h (note 3 in the technical data, chapter 5) (1)		1 minute
Recording type (2) (chapter 14)	 Off	recording switched off permanently	Off
	 Continuous	recording switched on permanently	
	 Limited by date and time	recording is active within the range of the Date and the Time defined by the Start and End parameters of time limit	
	 Periodic daily (hourly)	recording is active within the range of the Time defined by the Start and End parameters of time limit	
	 Above the permission threshold	recording is active when the measured value of the channel defined by the Selection of permission channel is larger than the value of the Permission threshold value parameter	
 Below the permission threshold	recording is active when the measured value of the channel defined by the Selection of permission channel is smaller than the value of the Permission threshold value parameter		
Start of time limit	Date: 01.06.2008 ÷ 31.12.2099, Time: 00:00:00 ÷ 23:59:59, the parameter is active when the Recording type = Limited by date and time or Periodic daily		2013.06.01 00:00:00
End of time limit	Date: 01.06.2008 ÷ 31.12.2099, Time: 00:00:00 ÷ 23:59:59, the parameter is active when the Recording type = Limited by date and time or Periodic daily		2013.06.01 00:00:00
Selection of permission channel	Measurement channel 1 ÷ Measurement channel 8 (16) or All channels the parameter is active when Recording type = Above or Below the permission threshold		Measurement channel 1
Permission threshold value	-199.9 ÷ 1999.9°C, -9999 ÷ 19999 units (3) or -9999 ÷ 99999 units (4), the parameter is active when Recording type = Above or Below the permission threshold		50.0 °C or l/m (4)

- Notes:** (1) - the recording interval is counted from the moment the device is disconnected from the USB port
 (2) - the device does not record data in a file when it is connected to the computer's USB port
 (3) - applies to analog inputs (mA, V, mV, Ω)
 (4) - applies only to the recorder version with pulse inputs

12.3. MEMORY OPTIONS AND OPERATIONS ON FILES

The recorder enables performing standard operations on files and disks from the menu level. The list of possible actions is given in the table below (12.3). These functions are blocked after the device is connected to a computer's USB port, which is due to the principle service of exchangeable disks (mass memories) by the operating system (Windows).

Table 12.3. Configuration parameters and file operations in the **Memory and file options** menu

Parameter or file action (operation)	Description of the available file operations and parameters		Factory settings
 Memory status	Cancel		Fig. 12.3. Appearance of the internal memory status screen (recording interval 1 s for 8 channels) The field " Storage capacity: " takes into account the Data recording interval (chapter 12.2) and the number of active measurement inputs (12.4, 12.5)
	Internal memory		
	USB memory		
 Copy archives to the USB memory (1)	Cancel	return to the previous menu (higher level)	
	Copy	copy the archive (files with the csv extension) from the internal memory to the USB	
 Delete all archives	Cancel	return to the previous menu (higher level)	
	Internal memory	delete the archive (files with the csv extension) from the internal memory	
	USB memory	delete the archive (files with the csv extension) from the USB memory	
 Archive storage memory (2)	Internal only	archive files are created only in the internal memory	Internal memory only
	Auto select	archive files are created in the USB memory (when detected) or the internal memory (when there is no USB memory)	
 Identification number (ID)	0÷999	an individual device number entered into the initial records in the archive file (csv) in order to distinguish archives from different recorders of the same type; it should be set before the recording starts	0
 Copy configuration to the USB memory	Cancel	return to the previous menu (higher level)	
	Copy	copy the current settings (<i>AR207.cfg</i> and <i>AR207.txt</i>) into the USB memory	
 Configure from the USB memory	Cancel	return to the previous menu (higher level)	
	Parameters	copy the configuration parameters (<i>AR207.cfg</i>) from the USB memory	
	Names	copy the names of channels, groups, and units (<i>AR207.txt</i>) from the USB memory	
	All	copy all settings (<i>AR207.cfg</i> and <i>AR207.txt</i>) from the USB memory	
 Restore default	Cancel	return to the previous menu (higher level)	
	Parameters	set the default configuration parameters (<i>AR207.cfg</i>) in the recorder	
	Names	set the default names and units (<i>AR207_names.txt</i>) in the recorder	
	All	set the default parameters and names (<i>AR207.cfg</i> and <i>AR207_names.txt</i>)	

Format the memory (3)	Cancel	return to the previous menu (higher level)
	Internal memory	format the internal memory in the FAT32 system, preserving the current settings (parameters in the file <i>AR207.cfg</i> and names in <i>AR207_names.txt</i>)

- Notes:** (1) - in the case of a 90 MB file, the copying time is equal to approx. 11 min. (approx. 135 kB/s, also depending on the type of memory)
- (2) - **Archive storage memory = Internal only** prevents unintentional creation of an archive in the USB put in the port by accident, in order to perform file operations or by unauthorized persons
- (3) - formatting deletes all data from the memory (with the exception of the configuration files), it is recommended in the case of problems with access to data





- during operations on files or formatting of the memory **do not shut off power supply** and **do not take out the USB memory** as it leads to the risk of loss of the recorded data or the active configuration (parameters and names)
- until the file operations or the formatting of memory is completed, the recording and the transmission of files with the measurement data via the Ethernet from the ARSOFT-WZ3 level are stopped

12.4. UNIVERSAL AND ANALOG MEASUREMENT INPUTS CONFIGURATION

Depending on the order code, the recorder may be in several versions with different number of universal and analog inputs: AR207/8 (8 universal inputs), AR207/16A (16 current inputs), AR207/16U (16 voltage inputs) or AR207/4P4 (4 universal inputs + 4 impulse inputs; additional description can be found in section 12.5).

Table 12.4. Configuration parameters in the **Input configuration** menu for the selected measurement channel (numbers 1÷8 for AR207/8 version or 1÷16 for current and/or voltage inputs or 1÷4 for AR207/4P4 version)

Parameter 	Range of variability of the parameter and description		Factory settings
 Name, unit and group	edition of the name of the channel and the group (max. length 16 characters) and the measurement unit (4 characters) is possible on the computer (via the USB port or the Ethernet and the ARSOFT-WZ1 software or by copying of the configuration - chapter 12.3). The format of a single section in the <i>AR207.txt</i> file is the following: <i>[Chan1] Name=Channel 1, unit=°C, [Group1] Name=Group 1</i>		<i>Channel i</i> (for $i=1\div 16$), °C, <i>Group j</i> (for $j=1\div 8$)
Input type	Off	the measurement channel is absent in the presentation and the recording	
	4÷20 mA or 2÷10 V	4÷20 mA or 2÷10 V signal	4÷20 mA or 2÷10 V
	0÷20 mA or 0÷10 V	0÷20 mA or 0÷10 V signal	
	the menu items present only in the recorder version with analog inputs (current or voltage)		
	Pt100	thermoresistance sensor (RTD) Pt100 (-200 ÷ 850°C)	Pt 100
	Pt500	thermoresistance sensor (RTD) Pt500 (-200 ÷ 620°C)	
	Pt1000	thermoresistance sensor (RTD) Pt1000 (-200 ÷ 620°C)	
	Ni100	thermoresistance sensor (RTD) Ni100 (-50 ÷ 170°C)	
	J (Fe-CuNi)	thermoelectric sensor (thermocouple) type J (-40 ÷ 800°C)	
	K (NiCr-NiAl)	thermoelectric sensor (thermocouple) type K (-40 ÷ 1,200°C)	
	S (PtRh 10-Pt)	thermoelectric sensor (thermocouple) type S (-40 ÷ 1,600°C)	
	B (PtRh30PtRh6)	thermoelectric sensor (thermocouple) type B (-300 ÷ 1,800°C)	
	R (PtRh13-Pt)	thermoelectric sensor (thermocouple) type R (-40 ÷ 1,600°C)	
	T (Cu-CuNi)	thermoelectric sensor (thermocouple) type T (-25 ÷ 350°C)	
E (NiCr-CuNi)	thermoelectric sensor (thermocouple) type E (-25 ÷ 850°C)		
N (NiCrSi-NiSi)	thermoelectric sensor (thermocouple) type N (-35 ÷ 1,300°C)		
4÷20 mA	current signal 4...20 mA		



	0÷20 mA	current signal 0...20 mA		
	0÷10 V	voltage signal 0...10 V		
	0÷60 mV	voltage signal 0...60 mV		
	0÷850 Ω	resistance signal 0...850 Ω		
Line resistance (1)	0.00÷50.00 Ω	total resistance of leads for 2-wire RTD sensors and 850 Ω		0 Ω
Thermocouple cold tip temperature	Auto 0.1÷60.0 °C	automatic or constant compensation of temperature of the cold junction of thermocouples		Auto
Decimal dot position/resolution	None	0, no point (2)	or resolution 1 °C for temperature (4)	Position 1 (0.0/0.1°C)
	Position 1	0.0 (2)	or resolution 0.1 °C for temperature (4)	
	Position 2	0.00 (2)		
	Position 3	0.000 (2)		
Bottom of the indication range	-199.9 ÷ 1999.9 °C or -9999 ÷ 19999 units (2) – indication for 0 mA, 4 mA, 0 V, 2 V, 0 mV, 0 Ω - start of the input scale			0.0 °C -100.0 °C (4)
Top of the indication range	-199.9 ÷ 1999.9 °C or -9999 ÷ 19999 units (2) – indication form 20 mA, 10 V, 60 mV, 850 Ω - end of the input scale			100.0 °C 800.0 °C (4)
Filtration (3)	1 ÷ 10	digital filtration of measurements (response time)		1
Offset calibration	zero offset: -50.0 ÷ 50.0 °C or -500 ÷ 500 units (2)			0.0 °C
Slope calibration	sensitivity (gain): 85.0 ÷ 115.0 %			100.0 %
Assignment of alarm outputs	combinations of Alarm outputs 1 ÷ 4 or None , selection of alarm outputs activated by the measurement of the current channel, chapter 12.6			Alarm out. i (for i=1÷4),
Assignment of the measurement group	channel Belongs to all groups or only to one group in the range of 1 ÷ 8 , channel grouping is used in the measurement presentation modes			Group i (for i=1÷4),
Background color	selection of the background color in the measurement presentation modes, 23 colors are available			color

Notes: (1) - in the case of 3-wire sensors, the **Line resistance** parameter must be equal to **0.00 Ω** (automatic compensation)
(2) - applies to analog inputs (mA, V, mV, Ω)
(3) - in the case of **Filtration=1** the response time is equal to 1 s, in the case of **Filtration=10** it is equal to at least 5s. Higher degree of filtration means a more "smooth" measured value and a longer response time, which is recommended in the case of turbulent measurements (e.g. water temperature in a boiler without an agitator)
(4) - applies only to a recorder version with universal inputs

12.5. PULSE MEASUREMENT INPUTS CONFIGURATION

The recorder may be in one of two versions with impulse inputs AR207/8P (8 impulse inputs) or AR207/4P4 (4 universal inputs + 4 impulse inputs; additional description can be found in section 12.4).

Table 12.5. Configuration parameters in the **Input configuration** menu for the selected measurement channel (numbers 1÷8 for AR207/8P version or 5÷8 for AR207/4P4 version)

Parameter 	Range of variability of the parameter and description	Factory settings
 Name, unit and group	edition of the name of the channel and the group (max. length 16 characters) and the measurement unit (4 characters) is possible on the computer (via the USB port or the Ethernet and the ARSOFT-WZ1 software or by copying of the configuration - chapter 12.3). The format of a single section in the AR207.txt file is the following: [Chan1] Name= Channel 1 , unit=°C, [Group1] Name= Group 1 For the main input working in the Flow measurement or the Flow totalizer mode, the unit is taken from configuration parameters (Volume and Time unit). In the case of frequency measurement, the displayed unit is Hz.	Channel i (for i=1÷8), I/m, Group j (for j=1÷8)

 Totalizer/counter reset	Totalizer and counter reset		-
Main input mode	Off	the measurement channel is absent in the presentation and the recording	<i>Flow measurement</i>
	Flow measurement	Flow [Volume unit / Time unit]	
	Flow totalizer	Totalizer [Volume unit]	
	Frequency measurement	Frequency [Hz]	
	Pulse counting	Pulse/events counting	
	Bistable input	Sets the value of Bottom/Top range for graphics	
Auxiliary input mode	Off	Inactive input	<i>Off</i>
	Totalizer/counter reset	Totalizer and counter reset	
Flowmeter K factor	0.0 ÷ 9999.9 str/l The value of 0.0 is interpreted by the recorder as 10 000.0 str/l		<i>100.0 str/l</i>
Volume unit for flow and totalizer	liter [l]		<i>liter [l]</i>
	hectolitre [hl]		
	cubic meter [m3]		
Time unit for flow and totalizer	second [s]		<i>minute [m]</i>
	minute [m]		
	hour [h]		
Decimal dot position/resolution	None	0, no point	<i>Position 1</i>
	Position 1	0.0	
	Position 2	0.00	
	Position 3	0.000	
Waiting time for a pulse	0.1 ÷ 30.0 s Time after which the indications are reset		<i>1 s</i>
Switch debounce time	0.00 ÷ 50.00 ms - insensibility time for contacts. The parameter identifies the minimum duration of impulse. Impulse whose duration is shorter than the specified duration will be considered as interferences.		<i>0.50 ms</i>
Filtration for measurements (1)	1 ÷ 10	digital filtration of measurements (response time) (1)	<i>1</i>
Bottom range for graphics	0 ÷ 99999 units –start of the scale for graphical widgets (bargraf, counter, chart) and indication for low level when Main input mode = Bistable input		<i>0.0 l/m</i>
Top range for graphics	0 ÷ 99999 units –end of the scale for graphical widgets (bargraf, counter, chart) and indication for high level when Main input mode = Bistable input		<i>5000.0 l/m</i>
Slope calibration (2)	sensitivity (gain): 85.0 ÷ 115.0 % (2)		<i>100.0 %</i>
Assignment of alarm outputs	combinations of Alarm outputs 1 ÷ 4 or None , selection of alarm outputs activated by the measurement of the current channel, chapter 12.6		<i>Alarm out. i (for i=1÷4),</i>
Assignment of measurement group	channel Belongs to all groups or only to one group in the range of 1 ÷ 8 , channel grouping is used in the measurement presentation modes		<i>Group i (for i=1÷4),</i>
Background colour	selection of the background color in the measurement presentation modes, 23 colors are available		<i>color</i>

Notes: (1) - The response time is dependent on the degree of filtration and pulse frequency. Higher degree of filtration means a more "smooth" measured value and a longer response time

(2) - Taken into account only for **Flow measurement** and **Frequency measurement** mode

Additional information and tips concerning configuration of impulse inputs:





- In the case of incorrect configuration of the **Switch debounce time** parameter, incorrect values will be indicated. This parameter must be set based on the maximum frequency and the flow meter output signal filling coefficient. If the manufacturer does not provide information on the impulse filling coefficient, 10% of the maximum frequency at the flow meter output can be assumed and the correctness of the measurement must be



- checked by determining experimentally the value of the **Switch debounce time** parameter. The maximum impulse frequency can be calculated based on the measurement scope and the flow meter K-factor. Correct selection of the **Switch debounce time** parameter is of key importance to proper measurement and stability of the measured value. The value of the parameter must be other than zero value if the flow meter that is used has a contact output.
- For proper measurement of flow or frequency by the recorder, at least 4 impulses are required.
 - The impulse module does not work with sensors with complementary NPN-PNP (push-pull) outputs. In such a case, signal conversion is required, e.g. by serial connection of a diode, between the output of the flow meter and the input of the impulse module. The diode must be connected by a qualified person.
 - Do not connect a pull-up resistor of the flow meter output to the power supply plus (+) terminal for flow meters with the open collector (OC) output of the NPN type.
 - The units displayed in the **Flow measurement**, **Flow totalizer**, and **Frequency measurement** modes are set automatically. The units are defined by the **Volume unit** and **Time unit** parameters. In the **Frequency measurement** the unit is **Hz**. In the other operating modes, the units are configured by the user.
 - **--HI--** is displayed if the range of the measurement frequency specified in the technical data (chapter 5, **Measured frequency range**) is exceeded and if the display range (chapter 5, **Indication range**) is exceeded.
 - In order to ensure simultaneous measurement of flow and balance by one sensor, the two measurement channels must be connected in parallel. In the case of one such connection within one impulse module (inputs 1÷4 or 5÷8), the maximum measurement frequency drops by 50% (5 kHz, 50 μs); in the case of two such connections - it drops by 75% (2.5 kHz, 100 μs). In recorder versions with one impulse module (inputs 5÷8), input 5 should be configured as **Flow measurement**, and input 6 - as **Balance counting**; similarly, input 7 should be in the **Flow measurement** mode and input 8 - in the **Balance counting mode**. In versions with two impulse modules (inputs 1÷8), it is recommended to connect channels 1 and 5, 2 and 6, 3 and 7, and 4 and 8.

12.6. CONFIGURATION OF ALARM OUTPUTS

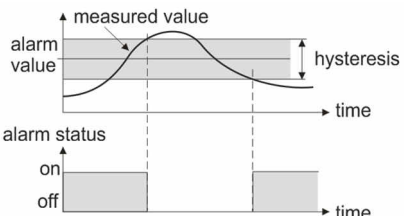
The **Outputs (alarm) configuration** menu comprises four identical sets of parameters grouped according to the output number described in the Table 12.6.1 and other items listed in the Table 12.6.2.

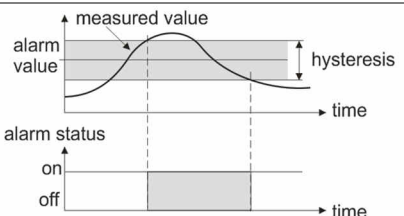

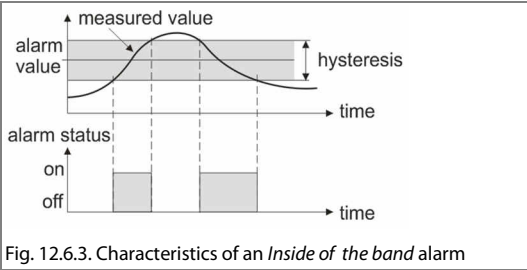
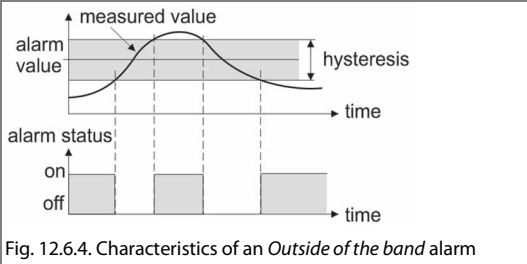
Table 12.6. Configuration parameters in the **Outputs (alarm) configuration** menu for the selected alarm output

Parameter	Range of variability of the parameter and description	Factory settings
 Assigned inputs	numbers of the measurement channels assigned to the selected alarm; the assignment is made in the Measurement inputs configuration menu (chapter 12.4, 12.5, parameter Assignment of alarm outputs)	1÷16 or None
Off	constantly switched off alarm output	Off
Inverted/heating 	 <p>Fig. 12.6.1. Characteristics of a <i>Heating</i> type alarm</p>	
Alarm type 		
Direct/cooling 	 <p>Fig. 12.6.2. Characteristics of a <i>Cooling</i> type alarm</p>	

	<p>Inside of the band</p> 	
	<p>Outside of the band</p> 	
<p> Alarm value</p>	<p>-199.9 ÷ 1999.9 °C, -9999 ÷ 19999 units (1) or -9999 ÷ 99999 units (2)</p>	<p>50.0 °C (l/m)</p>
<p> Hysteresis</p>	<p>0 ÷ 500.0 °C or 0 ÷ 5000 units (1)</p>	<p>0.0 °C (l/m)</p>

Notes: (1) – applies to analog inputs (mA, V, mV, Ω)
(2) – applies only to the recorder version with pulse inputs

Table 12.6.2: Other configuration parameters in the **Output (alarms) configuration** menu

Parameter	Range of variability of the parameter		Factory settings
<p> Alarm sound signal</p>	<p>Disabled</p>	<p>the parameter controls the operation of the integrated acoustic transducer (buzzer) which enables signaling of switching on of any of the alarm outputs. This parameter can also be controlled from the level of the [F] function button, chapter 10, item c.</p>	<p>Disabled</p>
<p>Enabled</p>	<p>Disabled</p>		
<p> E-mail alarm notifications</p>	<p>Disabled</p>	<p>a service that enables signalization of any alarm outputs being switched on via an email message; the description can be found in chapter 12.6.1</p>	<p>Disabled</p>
<p>Enabled</p>	<p> E-mail settings and status</p>		

12.6.1. E-MAIL ALARM NOTIFICATIONS

The use of the email service requires a properly configured Ethernet interface (as described in chapter 12.8 COMMUNICATION OPTIONS...) and access parameters to the email account (SMTP outgoing mail server). The configuration data of the email client is stored in the AR207.txt file. The way to access this data is described above in chapter 12.6, in Table 12.6.2, in item **Email settings and status**. In order to eventually start the configured

service, the **Email alarm notifications** must additionally be set to the **Enabled** value (chapter 12.6, Table 12.6.2). Message can be sent to multiple recipients at the same time. Notifications are sent whenever any of the alarm outputs is switched on.

The individual components of the email message are created in accordance with the following rules:

- the **Subject** field contains the *NetBIOS name* of the device (default value *AR207*; the description can be found in chapter 12.8, Table 12.8);
- the **From** (Sender) field contains the name (address) of the email (SMTP server) user;
- in the **body** of the message there are the numbers of the active alarm outputs and the numbers, names, units, and measured values of the measurement channels that caused the relevant alarms.

For the purpose of text representation, Windows-1250 code page is used.

If a new alarm occurs, the device attempts to send an email until it is successful or until the relevant alarm is switched off. Because the device only sends notifications about current alarms and does not create a queue (history) to be sent, one must keep in mind that if the mail server is not accessible the alarms taking place at that time may not be noticed.

The number of emails sent is displayed in the device status window (which can be called using the **[F]+[ESC]** buttons or the **[F]** button, see chapter 10) and in the menu item **Email settings and status** (Table 12.6.2).

By using online SMS gateways, the emails can also be sent in the form of text messages to cellphones operating in GSM networks.

NOTE: 

Before the *AR207.txt* file is modified manually in a text editor, make a backup copy of the file (to use later in the event of problems with improper configuration, when default settings were restored).

12.7. DISPLAY SETTINGS

Table 12.7. Configuration parameters in the **Display settings** menu





Parameter 	Range of variability of the parameter and description									Factory settings
Screen backlight time	0 ÷ 60 min., increase by 1 min., for the 0 value the illumination is on all the time, the time is counted from the last use of the keypad or the touch screen									0 min. (continuous illumination)
Brightness of the screen	20 ÷ 100 %, change by 5%									100%
Channel and group auto switch time	0 ÷ 60 s, change every 2 s, for the 0 value, the automatic change is off, the time of automatic change of the channel (chart) and the group in the measurement presentation modes									0 s
Chart time range	100 s	300 s	15 min.	30 min.	60 min.	150 min.	5 h	10 h	25 h	100 s
	50h	5days	10days							
Language	Polish, English, the language of the menu (also covers the version of the web server page)									Polish

12.8. SERIAL RS485, USB, AND ETHERNET COMMUNICATION SETTINGS

The available interfaces enable communication with the computer and, consequently, the readout of the measured value and configuration of the parameters and the names, as well as access to the archive files (with the exception of the RS485). Moreover, the Ethernet enables displaying information on the operating status and on measurements of the recorder in any web browser (Opera, IE, Firefox, etc.) via the local network or the Internet and sending e-mail alarm notifications (chapter 12.6.1). The web server uses the HTTP protocol on the standard port **80**. The Internet connection requires a permanent global IP number and router (modem) configuration. To facilitate access to the networks with varying public IP address, one can start the built-in DDNS server service (described in chapter 12.8.1). **The selection of the TCP and UDP port number used by the recorder and the forwarding of this port in the router and other network parameters configurations should be performed by**

a **qualified person (the network administrator)**. Moreover, one must make sure that the firewall does not block the ports and applications being used (ARSOFT-WZ1 and WZ3 and the MODBUS-TCP protocol).

Table 12.8. Configuration parameters in the **Communication settings** menu

Parameter 	Range of variability of the parameter and description				Factory settings
USB operation mode	 Available for a computer (device) (1)	in order to establish communication with the computer, drivers must be installed (chapter 8); the USB connection is indicated in the lower status bar (chapter 11.1, item b)			Available for a computer
	 USB memory support (host)	the presence of the USB memory is indicated in the lower status bar (chapter 11.1), do not connect to the computer's USB port			
Baud rate for the RS485	2,400 bit/s	4,800 bit/s	9,600 bit/s	19,200 bit/s	19,200 bit/s
	38,400 bit/s	57,600 bit/s	115,200 bit/s		
MODBUS-RTU address	1 ÷ 247	individual address of the device in the RS485 network (chapter 18)			1
Ethernet operation mode	Disabled	Ethernet constantly off (recommended when not in use)			Off
	Automatic configuration	the DHCP client is on, parameters IP address , Subnet mask , Default gateway and DNS server are set automatically			
	Manual configuration	the DHCP client is off, parameters IP address , Subnet mask , and Default gateway are set manually			
	DHCP server	useful for direct connection with a computer; do not use in networks with an existing DHCP server, after this option is set, the device must be restarted			
 NetBIOS name	a unique name of the recorder in the local network; may be used instead of the IP address in order to establish a connection with a computer. Edition of the name (no spaces, max. length 15 characters) is possible on the computer (via the USB port or the Ethernet and the ARSOFT-WZ1 software, or by copying of the configuration - chapter 12.3). The format of a section in the AR207.txt file is the following: [Ethernet] NetBIOSName=AR207. The changed name may not be available on the network immediately (the update time depends on the configuration of the network).				AR207
UDP and TCP ports	80 ÷ 32767 (except for 137)	the port number and the individual IP address of the device for communication using the MODBUS-TCP protocol and with the ARSOFT-WZ1 and -WZ3 software and the web browser (in the address field, enter http://IP address or NetBIOS name , e.g. http://192.168.0.207 or http://AR207)			30207
IP address	0.0.0.0 ÷ 255.255.255.255				192.168.0.207
Subnet mask	0.0.0.0 ÷ 255.255.255.255	IP address mask in the local network	255.255.255.0		
Default gateway	0.0.0.0 ÷ 255.255.255.255	IP address of the router in the local network	192.168.0.10		
DNS server	0.0.0.0 ÷ 255.255.255.255	domain name server address (DNS)	192.168.0.10		
Dynamic DNS server client (DDNS)	Disabled	a DDNS service that enables access over the Internet to a recorder connected to a network without a fixed public IP address; an active account in a DDNS service is required; the description can be found in chapter 12.8.1.			Disabled
	Enabled				
 Dynamic DNS settings and status	Configuration data and status of the DDNS service. The data can be changed on the computer (via the USB port or the Ethernet and the ARSOFT-WZ1 software, or by copying of the configuration - chapter 12.3). Available parameters of the service: DDNS server index, host name, username and password. The default section [DDNS] in the AR207.txt file is the following: <i>ServiceIndex=1</i> (0=DYNDNS_ORG, 1=NO_IP_COM, 2=DNSOMATIC_COM), <i>Host=AR207example.ddns.com</i> , <i>UserName= DDNSuser</i> , <i>Password= DDNSpassword</i>				

Website automatic refresh time	0 ÷ 60 s , change every 1 s, in the case of the 0 value, automatic refreshing is switched off (manual refreshing), it is used by the web server	5 s
 Ethernet MAC address	a unique permanent hardware address of the Ethernet interface (factory-assigned, non-modifiable)	

Notes: (1) - when the recorder is connected to a computer's USB port, the recording is stopped until the cable is disconnected and file operations accessible from the menu level and transmission of files with measurement data via the Ethernet from the ARSOFT-WZ3 level are stopped

NOTE: 

Do not connect the device in the **USB memory support (host)** mode to the USB port of a computer as this leads to the risk of damage to ports. **In the IP30 version, do not use two USB sockets at the same time.**

12.8.1. DYNAMIC DNS (DDNS) SERVER CLIENT

The DDNS service enables easy access over the Internet to a recorder connected to a network without a fixed public IP address using a friendly host name (Internet address) defined by the user. The service is available only to registered users of popular DDNS services, such as DynDNS (www.dyndns.org), No-IP (www.no-ip.com), and DNS-O-Matic (www.dnsomatic.com).

The use of the DDNS service requires a properly configured Ethernet interface (as described in chapter 12.8 COMMUNICATION OPTIONS...) and access parameters to the DNS server account. The configuration data of the DDNS service client is stored in the *AR207.txt* file. The way to access this data is described above in chapter 12.8, in Table 12.8, in item **DDNS client settings and status**. In order to eventually start the configured service, one must additionally set the **Dynamic DNS server client** to the value of **Enabled** (Table 12.8). In order for the changes in the DDNS configuration to be implemented immediately, switch off and on the DDNS service, disconnect the Ethernet cable for a brief moment, or restart the device; otherwise, the update will be implemented after not more than 10 minutes after the changes are made. Reliability of the service depends on the availability and load of the DDNS service and delays in the update of the address may reach several dozen minutes.

The public IP address of the network in which the recorder is operating and the status of the DDNS service are displayed in the device status window (which can be called using the **[F]+[ESC]** buttons or the **[F]** button, see chapter 10) and in the menu item **DDNS client settings and status** (Table 12.8). The *DDNS:OK* status indicates that the last update of the address in the DDNS service was implemented correctly; other codes may be of intermittent nature (e.g. *DDNS:17* means initiation and *DDNS:13* or *15* means temporary unavailability of the service) or permanent nature, which indicates inadequate Internet connection, improper configuration of the connection or service (codes 2 to 12, e.g. *DDNS:5* means invalid username or password, *DDNS:8* means invalid host name, and *DDNS:11* means unspecified error of the DDNS service).

Access to the Internet using a public IP address (host name) may be blocked by some Internet providers; in such cases, contact your operator's customer service office.

In order to use the services of other NO-IP (*ServiceIndex* =1 in *AR207.txt*) and DynDNS (*ServiceIndex* =0) service providers, configure an account in the Internet service DNS-O-Matic (*ServiceIndex* =2) and in the recorder (the host name can be set as *all.dnsomatic.com* or as the address of the host created in another service supported by DNS-O-Matic).

NOTE: 

Before the *AR207.txt* file is modified manually in a text editor, make a backup copy of the file (to use later in the event of problems with improper configuration, when default settings were restored).

12.9. ACCESS AND OTHER SETTINGS

Table 12.9. Configuration parameters in the *Access and other options* menu

Parameter 	Range of variability of the parameter and description		Factory settings
Password protection (1)	Disabled - entry into the <i>Main menu</i> and remote access are not password-protected		<i>Manual configuration and remote access</i>
	Manual configuration and remote access - the <i>Main menu</i> and remote access are protected		
	Manual configuration only - only the <i>Main menu</i> of the device is protected		
	Remote access only - only the remote access is protected		
Access password	0000 ÷ 9999	password for entry into the <i>Main menu</i> and for remote access	<i>1111</i>
F button function (chapter 10)	Device status - device status screen (available also via [F]+[ESC] buttons)		<i>Device status</i>
	Stop/Start of recording - change of the Recording type parameter to Off or Continuous (chapter 12.2), after the power supply is switched on, the recording is always on (continuous)		
	Copy archives to the USB memory (operation accessible also in the Memory and file options menu, chapter 12.3)		
	Move archives to the USB memory - the files in the recorder are deleted after they have been copied		
	Disable/Enable sound alarm - change of the Alarm sound signal parameter to Disabled or Enabled (chapter 12.6, Outputs (alarm) configuration menu), after the power supply has been switched on, the sound signaling of all alarm is always on		
	Block/Unblock all alarms – after the power supply has been switched on, all alarm outputs are always in operation in accordance with the programmed characteristics (chapter 12.6)		
	Touch panel lock – display touch panel and hardware buttons lock (except [F])		
Buttons and touch sounds	Disabled	no sound indicating selection of elements of the screen and of hardware buttons	<i>On</i>
	Enabled	the sound indicating selection of elements of the screen and of hardware buttons is active	

Notes: (1) - password protection of remote access pertains to communication with the ARSOFT-WZ1 (parameter configuration) and ARSOFT-WZ3 (downloading files with measurement via the Ethernet interface)

12.10. DATE AND TIME

The current time and date are displayed in the upper status bar (chapter 11.1) in all the modes of presentation of measurement data and are used as time markers for recording.

In order to maintain the operation of the internal clock (RTC) when there is no external power supply, the device is provided with a CR1220 lithium battery that is sufficient for 5 years of continuous operation.

Table 12.10. Configuration parameters in the *Date and time* menu

Parameter	Range of variability of the parameter
Date (yyyy-mm-dd)	2008-06-01 ÷ 2099-12-31
Time (hh:mm:ss)	00:00:00 ÷ 23:59:59

12.11. DEVICE INFORMATION



Element	Description
1	type of device (AR207), number of channels and type of available measurement modules
2	recorder's software (firmware) version

Fig. 12.11. Appearance of the **Device information** screen

13. USE AND FUNCTIONS OF USB MEMORY (PENDRIVE)

Due to the stationary (panel) installation of the recorder, it may be useful to use a USB memory to transfer archive data or configuration data.

All the available file and disk operations can be found in the **Main menu** -> **Memory and file options**, chapter 12.3. They enable copying and deleting archive and configuration files and checking the size of the memory and the file system. In the aforementioned operations, the presence of USB memory in the port is detected automatically.

Moreover, it is possible to select a USB memory for continuous storage of the archive. To do so, set the **Archive storage memory** parameter to the **Auto select** value (chapter 12.3) and also in the **Main menu** ->

Communication settings, set the **USB operation mode** to the **USB memory support (host)** value, chapter 12.8.

In conclusion, a USB memory that is correctly installed in the socket has the following functions:

- storage of files with saved data in the course of recording
- off-line configuration of the device's parameters (from files *AR207.cfg* and *AR207.txt*, see chapter 12, item 3)
- copying archive files with the "csv" extension from the internal memory

NOTE:



In the IP30 version, **do not use** two USB sockets at the same time from the front as this leads to the risk of damage to the equipment.

14. VIEWING RECORDED MEASUREMENTS AND EVENTS

In order to archive the data, the recorder creates text files with the "csv" extension in the internal memory or the USB memory. Further, the new csv files are created each time after power up, and at the start of a new recording (e.g. when the parameter **Recording type = Periodic daily (hourly)** new files are created every day). The file name contains the device type (AR207), the identification number (**ID**) (chapter 12.3), and the date and time of creation of the file, e.g. "AR207_1_2013-10-09_10-57-16.csv" (AR207, ID = 1, date = 2013-10-09, time = 10:57:16).

The format of a single data record is the following:

"successive number of the event;date;time;identifier of the event;argument 1;...;argument n;check sum", where n=number of channels (8 or 16).

An example of a record containing measurements:

"1;2013-10-09;10:57:16;5;49,5;26,2;19,80;1020;...;8BE2" (where the measured values are "49,5;26,2;19,80;1020;...").

The types and the identifiers of the recorded events are:

- measurement (identifier of event **5**)
- connection to the USB port (**0**, "USB;CONNECTED")
- disconnection from the USB port (**1**, "USB;DISCONN")
- loading of a new configuration (identifier of event **3**), values of arguments:
 - "NEW;ON-LINE" - parameter configuration via the USB port, the RS485 port, or the Ethernet (on-line)
 - "NEW;OFF-LINE" - parameter configuration by way of modification of the *AR207.cfg* file (off-line)

- "NEW;USER" - parameter configuration from the keypad and touch screen (user) level
- "NEW;CH_TEXT" - name configuration by way of modification of the AR207.txt file
- creation of a new "csv" file (4, "ID;xxxx", where xxxx - value of the **Identification number ID** parameter of the device, chapter 12.3, Table 12.3)

In order to make a graphic or text presentation, or to print the recorded results, one must import the data into the ARSOFT-WZ3 software via the USB or the Ethernet interface. The quickest possible method is to import the data via the computer's USB; it is recommended in case of very large files (hundreds of megabytes and larger). The ARSOFT-WZ3 software also enables detecting unauthorized modifications of the archive.

As an alternative, "csv" files can be edited in spreadsheet software (e.g. OpenOffice Calc, Microsoft Excel) and in text editors (Windows WordPad, Notepad++, etc.).

NOTE: 

When parameter **Archive storage memory = Auto select** (chapter 12.3) then if the USB memory is installed or removed in the course of recording, a new "csv" file is created where the successive numbers of events are continued from the previous file.

15. MESSAGE AND ERROR SIGNALING

The measurement errors present in the field of the measured values in all presentation modes:

- HI-- - the value set by the **Top of the indication range** is exceeded from the top (chapter 12.4, 12.5), the measurement range of a sensor is exceeded from the top or the sensor is damaged
- LO-- - the value set by the **Bottom of the indication range** is exceeded from the bottom (chapter 12.4, 12.5), the measurement range of a sensor is exceeded from the bottom or the sensor is damaged

Also, the recorder has a clear way of informing of its operating status and the status of the file or disk operations being performed. In order to close the message window appearing in the display, use the **[SET]** or **[ESC]** button.

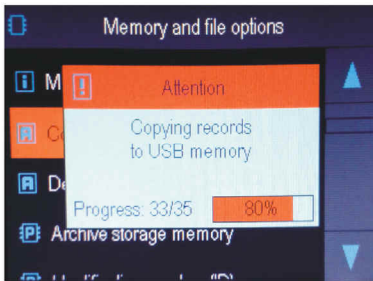

Fig. 15. Appearance of an example message window.

16. IMPORTANT COMMENTS PERTAINING TO OPERATION

In order to ensure problem-free and optimum operation of the recorder, please observe the following guidelines:

- do not disconnect the device from the computer in the course of communication via the USB interface, which is indicated with the **[R/W]** and **[Tx/Rx]** icons. USB communication is in place when the internal memory is serviced and in the course of operation of the ARSOFT-WZ1 software.
- delete unnecessary files from the internal memory or the USB memory before new recording start
- save security copies in external memories (USB, computer disks, etc.) of the current configuration files (AR207.cfg and AR207.txt) to be used in case of problems
- **do not allow power loss during recording of data** as it leads to the risk of errors in the FAT file system and, consequently, to problems with data recording/reading and loss of the current configuration of the recorder and restoration of the default (factory) configuration. If this happens, perform the following actions from the **Main menu** level of the device or using a computer connected via the USB port:
 1. copy (if possible) the existing archive files to an external memory (a USB memory or the computer's disk)
 2. format the internal memory
 3. configure the recorder (manually, on-line, or off-line by restoration of the copies of the configuration

files, if the user has made them)

- **do not** establish communication with the device **simultaneously** from many applications of the same type (ARSOFT-WZ1/WZ3)
- **do not use sharp-edged objects to work with the touch screen**
- avoid exposing the device to direct sunlight and other sources of intensive heat
- when the recorder is connected to the USB port of a computer, recording is stopped until the cable is disconnected and the file operations accessible from the menu level and the transmission of files with the measurement data via the Ethernet from the ARSOFT-WZ3 is stopped

17. RS485 COMMUNICATION INTERFACE (acc. to EIA RS-485)

The installation specification for the RS485 interface is the following:

- maximum cable length - 1 km (observe the installation guidelines, chapter 2, sub-items b, c, and d)
- maximum number of devices in a RS485 line - 30, in order to increase the number, use RS485/RS485 amplifiers
- termination and polarizing resistors when the MASTER is at the start of the line (Fig. 17):
 - at the start of the line - $2 \times 820 \Omega$ to the ground and +5 V of the MASTER and 150Ω between lines
 - at the end of the line - 150Ω between lines
- termination and polarizing resistors when the MASTER is in the center of the line:
 - at the converter - $2 \times 820 \Omega$, to the ground and +5 V of the converter
 - at both ends of the line - 150Ω each between lines

Equipment from different manufacturers that form the RS485 network (e.g. RS485 converters/USB) may have integrated polarizing and terminating resistors; in such a case there is no need to use external elements.

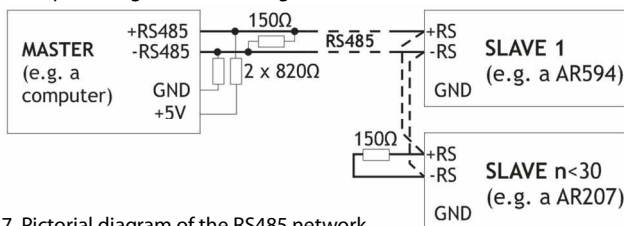

Fig. 17. Pictorial diagram of the RS485 network

18. MODBUS-RTU SERIAL TRANSMISSION PROTOCOL (SLAVE)

The MODBUS-RTU protocol is accessible to the RS485 interface and the USB (in the device mode). The parameters used by this service are described in chapter 12.8.

Character format: 8 bits, 1 stop bit, no parity bit

Available functions: READ - 3 or 4, WRITE - 6

Table 18.1. Request frame format for the READ function (frame length - 8 bytes):

address of the device	function 4 or 3	address of the read register from Table 20 (chapter 20)	number of read registers: $1 \div 32$ (0x0020)	CRC check sum
1 byte	1 byte	2 bytes (HB-LB)	2 bytes (HB-LB)	2 bytes (LB-HB)

Example 18.1. Reading of a register with address 0: 0x01 - 0x04 - 0x0000 - 0x0001 - 0x31CA

Table 18.2. Request frame format for the WRITE function (frame length - 8 bytes):

address of the device	function 6	address of the write register from Table 20 (chapter 20)	write register value	CRC check sum
1 byte	1 byte	2 bytes (HB-LB)	2 bytes (HB-LB)	2 bytes (LB-HB)

Example 18.2. Write in a register with address 10 (0xA) with the 0 value: 0x01 - 0x06 - 0x000A - 0x0000 - 0xA9C8

Table 18.3. Response frame format for the READ function (minimum frame length - 7 bytes):

address of the device	function 4 or 3	number of bytes in the data field (max. $32 \times 2 = 64$ bytes)	data field - register value	CRC check sum
1 byte	1 byte	1 byte	$2 \div 64$ bytes (HB-LB)	2 bytes (LB-HB)

Example 18.3. Response frame for register value equal to 0: 0x01 - 0x04 - 0x02 - 0x0000 - 0xB930

Table 18.4. Response frame format for the WRITE function (frame length - 8 bytes):

copy of the request frame for the WRITE function (Table 18.2)

Table 18.5. Special answer (errors: function field = 0x84 or 0x83 in the case of the READ function and 0x86 in the case of the WRITE function):

Error code (HB-LB in the data field)	Error description
0x0001	non-existing register address
0x0002	wrong write register value
0x0003	improper function number

Example 18.5. Error frame for a non-existing read register address: 0x01 - 0x84 - 0x02 - 0x0001 - 0x5130

19. MODBUS-TCP SERIAL TRANSMISSION PROTOCOL

The MODBUS-TCP protocol is accessible to the Ethernet (RJ45) interface and uses the TCP/IP transport layer. The parameters used by the service, to include the TCP port number, are described in chapter 12.8.

Available functions: READ - 3 or 4, WRITE - 6

Table 19.1. Request frame format of the MODBUS-TCP protocol for the READ and WRITE functions (length - 12B)

Heading of the MODBUS protocol (7 bytes)			Function code (READ or WRITE)	register address from Table 20 (chapter 20)	number of read registers (1-32) or value of read register
Transaction and protocol identifiers	Length field (value = 6)	Unit identifier			
4 bytes	2 bytes	1 byte	1 byte	2 bytes (HB-LB)	2 bytes (HB-LB)

Example 19.1. Reading of a register with address 0: 0x00-0x00-0x00-0x00-0x00-0x06-0xFF-0x04-0x0000-0x0001

Table 19.2. Response frame format for the READ function (minimum frame length - 11 bytes):

Heading of the MODBUS protocol (7 bytes)			Function code (READ)	number of bytes in the data field (2-64)	data field - register value (2B)
Transaction and protocol identifiers	Length field (maximum 67)	Unit identifier			
4 bytes	2 bytes	1 byte	1 byte	1 byte	2 ÷ 64 bytes (HB-LB)

Example 19.2. Response frame for register value equal to 0:

0x00 - 0x00 - 0x00 - 0x00 - 0x00 - 0x05 - 0xFF - 0x04 - 0x01 - 0x0000

Table 19.3. Response frame format for the WRITE function (frame length - 12 bytes)

copy of the request frame for the WRITE function (Table 19.1)

The error codes are the same as in the case of the MODBUS-RTU protocol (Table 18.5)

Example 19.4. Error frame for a non-existing read register address:

0x00 - 0x00 - 0x00 - 0x00 - 0x00 - 0x05 - 0xFF - 0x84 - 0x02 - 0x0001

20. MAP OF DEVICE REGISTERS FOR THE MODBUS-RTU/TCP

Table 20. Map of registers for the MODBUS-RTU and MODBUS-TCP protocols

Register address HEX (DEC)	Range of variability or value of the register (HEX or DEC)	Description of register and access type (R- read only register, R/W - read and write register)	
0x00 (0)	0	not used	R
0x01 (1)	2070 ÷ 20820	device type identifier (depending on the hardware version)	R
0x02 (2)	100 ÷ 999	recorder's software (firmware) version	R
0x03 (3)	-100 ÷ 700	internal device temperature (resolution 0.1°C), no decimal point	R
0x04 (4)	0 ÷ 15	current status of outputs 1, 2, 3, 4: bits 3, 2, 1, 0 bit=1 means the output is switched on	R
0x05 ÷ 0x0B	0	not used or reserved	R

0x0C ÷ 0x1B	-9999 ÷ 19999	measurement value (U2 code)	channel 1÷16 (1 register/chan, 16-bit)	no decimal point (for thermometric inputs resolution 0,1°C)	R
	-9999 ÷ 99999 (3)		channel 1÷8 (2 registers/chan, 32-bit)		
0x1C (28)	0 ÷ 6	day of the week in the internal RTC clock (counted based on the date)			R
0x1D (29)	0x0101 ÷ 0x630C	years (HB) and months (LB)	Internal real time clock (RTC , chapter 12.10)		R/W
0x1E(30)	0x0100 ÷ 0x1F17	days (HB) and hours (LB)			R/W
0x1F (31)	0x0000 ÷ 0x3B3B	minutes (HB) and seconds (LB)			R/W
0x20 (32)	0x0101 ÷ 0x630C	years (HB) and months (LB)			Parameter Start of the time limit (chapter 12.2)
0x21 (33)	0x0100 ÷ 0x1F17	days (HB) and hours (LB)	R/W		
0x22 (34)	0x0000 ÷ 0x3B3B	minutes (HB) and seconds (LB)	R/W		
0x23 (35)	0x0101 ÷ 0x630C	years (HB) and months (LB)	Parameter End of the time limit (chapter 12.2)	R/W	
0x24 (36)	0x0100 ÷ 0x1F17	days (HB) and hours (LB)		R/W	
0x25 (37)	0x0000 ÷ 0x3B3B	minutes (HB) and seconds (LB)		R/W	
0x26 (38)	1 ÷ 28800	Parameter Data recording interval (chapter 12.2) – number of seconds			R/W
0x27 (39)	0 ÷ 5	Parameter Recording type (chapter 12.2)			R/W
0x28 (40)	0 ÷ 7 (1) lub 0 ÷ 15	Parameter Selection of permission channel (chapter 12.2)			R/W

Map of registers according to recorder version

Register address HEX (DEC)				Range of variability of the register	Description of register (R/W type configuration parameters)
Version AR207/8	16-channel version (2)	Version AR207/8P	Version AR207/4P4		
0x29 (41)	0x29 (41)	0x29 ÷ 0x2A	0x29 ÷ 0x2A	-9999÷19999, -9999÷99999 (3)	Permission threshold value (chapter 12.2), 2 registers for pulse inputs
0x2A (42)	0x2A (42)	0x2B (43)	0x2B (43)	0 ÷ 2	Archive storage memory (chapter 12.2)
Configuration parameters for the measurement channel numbered CN = 0÷7 or 0÷15 (2), 0= channel 1, 7= channel 8, etc.					
0x2B + CN*12	0x2B + CN*10	-	0x2C + CN*12 (4)	0 ÷ 17	Input type (chapter 12.4)
0x2C + CN*12	-	-	0x2D + CN*12 (4)	0 ÷ 5000	Line resistance (chapter 12.4) (1)
0x2D + CN*12	-	-	0x2E + CN*12 (4)	0 ÷ 600	Thermocouple cold tip temper. (12.4) (1)
-	-	0x2C + CN*18	0x5C+(CN-4)*18 (5)	0 ÷ 5	Main input mode (chapter 12.5) (3)
-	-	0x2D + CN*18	0x5D+(CN-4)*18 (5)	0 ÷ 1	Auxiliary input mode (chapter 12.5) (3)
-	-	0x2E + CN*18	0x5E+(CN-4)*18 (5)	0 ÷ 99999	Flowmeter K factor (12.5) (3), 2 registers
-	-	0x30 + CN*18	0x60+(CN-4)*18 (5)	0 ÷ 2	Volume unit (chapter 12.5) (3)
-	-	0x31 + CN*18	0x61+(CN-4)*18 (5)	0 ÷ 2	Time unit (chapter 12.5) (3)
0x2E + CN*12	0x2C + CN*10	0x32 + CN*18	0x2F + CN*12 (4), 0x62+(CN-4)*18 (5)	0 ÷ 3	Decimal dot position/resolution (12.4, 12.5)
-	-	0x33 + CN*18	0x63+(CN-4)*18 (5)	1 ÷ 300	Waiting time for a pulse (chap.12.5) (3)
-	-	0x34 + CN*18	0x64+(CN-4)*18 (5)	0 ÷ 5000	Switch debounce time (chap.12.5) (3)
0x2F + CN*12	0x2D + CN*10	0x35 + CN*18	0x30 + CN*12 (4), 0x65+(CN-4)*18 (5)	-9999 ÷ 19999 -9999÷99999 (3)	Bottom of the indication range (chapter 12.4, 12.5), 2 registers for pulse inputs
0x30 + CN*12	0x2E + CN*10	0x37 + CN*18	0x31 + CN*12 (4), 0x67+(CN-4)*18 (5)	-9999 ÷ 19999 -9999÷99999 (3)	Top of the indication range (chapter 12.4, 12.5), 2 registers for pulse inputs
0x31 + CN*12	0x2F + CN*10	0x39 + CN*18	0x32 + CN*12 (4), 0x69+(CN-4)*18 (5)	0 ÷ 10	Filtration (chapter 12.4, 12.5)
0x32 + CN*12	0x30 + CN*10	-	0x33 + CN*12 (4)	-500 ÷ 500	Offset calibration (chapter 12.4, 12.5)
0x33 + CN*12	0x31 + CN*10	0x3A + CN*18	0x34 + CN*12 (4), 0x6A+(CN-4)*18 (5)	850 ÷ 1150	Slope calibration (chapter 12.4, 12.5)
0x34 + CN*12	0x32 + CN*10	0x3B + CN*18	0x35 + CN*12 (4), 0x6B+(CN-4)*18 (5)	0 ÷ 8	Assignment of alarm outputs (chapter 12.4, 12.5)

0x35 + CN*12	0x33 + CN*10	0x3C + CN*18	0x36 + CN*12 (4), 0x6C+(CN-4)*18 (5)	0 ÷ 8	Assignment of measurement group (chapter 12.4, 12.5)	
0x36 + CN*12	0x34 + CN*10	0x3D + CN*18	0x37 + CN*12 (4), 0x6D+(CN-4)*18 (5)	0 ÷ 22	Background color (chapter 12.4, 12.5)	
Configuration parameters of an alarm channel numbered AN = 0 ÷ 3 (0= channel 1, 3= channel 4)						
0x8B + AN*3	0xCB + AN*3	0xBC + AN*4	0xA4 + AN*4	0 ÷ 4	Type of alarm (chapter 12.6)	
0x8C + AN*3	0xCC + AN*3	0xBD + AN*4	0xA5 + AN*4	0 ÷ 5000	Hysteresis (chapter 12.6)	
0x8D + AN*3	0xCD + AN*3	0xBE + AN*4	0xA6 + AN*4	-9999 ÷ 19999, -9999÷99999 (3)	Alarm value (chapter 12.6), 2 registers for pulse inputs	
0x97 (151)	0xD7 (215)	0xCC (204)	0xB4 (180)	0 ÷ 1	Sound alarm signaling (chapter 12.6)	
0x98 (152)	0xD8 (216)	0xCD (205)	0xB5 (181)	0 ÷ 1	E-mail alarm notifications (12.6.1)	
0x99 (153)	0xD9 (217)	0xCE (206)	0xB6 (182)	0 ÷ 6	F button function (chapter 12.9)	
0x9A (154)	0xDA (218)	0xCF (207)	0xB7 (183)	0 ÷ 1	Buttons and touch sounds (12.9)	
0x9B (155)	0xDB (219)	0xD0 (208)	0xB8 (184)	0 ÷ 3	Password protection (chapter 12.9)	
0x9C (156)	0xDC (220)	0xD1 (209)	0xB9 (185)	0 ÷ 9999	Access password (chapter 12.9)	
0x9D (157)	0xDD (221)	0xD2 (210)	0xBA (186)	0 ÷ 9999	Identification number ID (chapter 12.3)	
0x9E (158)	0xDE (222)	0xD3 (211)	0xBB (187)	0 ÷ 60	Screen backlight time (chapter 12.7)	
0x9F (159)	0xDF (223)	0xD4 (212)	0xBC (188)	20 ÷ 100	Brightness of the screen (chapter 12.7)	
0xA0 (160)	0xE0 (224)	0xD5 (213)	0xBD (189)	0 ÷ 60	Channel and group auto switch time (12.7)	
0xA1 (161)	0xE1 (225)	0xD6 (214)	0xBE (190)	0 ÷ 11	Chart time range (chapter 12.7)	
0xA2 (162)	0xE2 (226)	0xD7 (215)	0xBF (191)	0 ÷ 1	Language (chapter 12.7)	
0xA3 (163)	0xE3 (227)	0xD8 (216)	0xC0 (192)	0 ÷ 1	USB operation mode (chapter 12.8)	
0xA4 (164)	0xE4 (228)	0xD9 (217)	0xC1 (193)	1 ÷ 247	MODBUS-RTU address (chapter 12.8)	
0xA5 (165)	0xE5 (229)	0xDA (218)	0xC2 (194)	0 ÷ 6	Baud rate for the RS485 (chapter 12.8)	
0xA6 (166)	0xE6 (230)	0xDB (219)	0xC3 (195)	0 ÷ 3	Ethernet operation mode (chapter 12.8)	
0xA7 (167)	0xE7 (231)	0xDC (220)	0xC4 (196)	80 ÷ 32767	UDP and TCP ports (chapter 12.8)	
0xA8 (168)	0xE8 (232)	0xDD (221)	0xC5 (197)	0x0000 ÷ 0xFFFF	Octet4 (HB), Octet3 (LB)	IP address (chapter 12.8)
0xA9 (169)	0xE9 (233)	0xDE (222)	0xC6 (198)	0x0000 ÷ 0xFFFF	Octet2 (HB), Octet1 (LB)	
0xAA (170)	0xEA (234)	0xDF (223)	0xC7 (199)	0x0000 ÷ 0xFFFF	Octet4 (HB), Octet3 (LB)	Subnet mask (chapter 12.8)
0xAB (171)	0xEB (235)	0xE0 (224)	0xC8 (200)	0x0000 ÷ 0xFFFF	Octet2 (HB), Octet1 (LB)	
0xAC (172)	0xEC (236)	0xE1 (225)	0xC9 (201)	0x0000 ÷ 0xFFFF	Octet4 (HB), Octet3 (LB)	Default gateway (12.8)
0xAD (173)	0xED (237)	0xE2 (226)	0xCA (202)	0x0000 ÷ 0xFFFF	Octet2 (HB), Octet1 (LB)	
0xAE (174)	0xEE (238)	0xE3 (227)	0xCB (203)	0x0000 ÷ 0xFFFF	Octet4 (HB), Octet3 (LB)	DNS server (rozdział 12.8)
0xAF (175)	0xEF (239)	0xE4 (228)	0xCC (204)	0x0000 ÷ 0xFFFF	Octet2 (HB), Octet1 (LB)	
0xB0 ÷ 0xB1	0xF0 ÷ 0xF1	0xE5 ÷ 0xE6	0xCD ÷ 0xCE	0	not used	
0xB2 (178)	0xF2 (242)	0xE7 (231)	0xCF (207)	0 ÷ 1	Dynamic DNS server client (12.8.1)	
0xB3 (179)	0xF3 (243)	0xE8 (232)	0xD0 (208)	0 ÷ 60	Website automatic refresh time (12.8)	

- Notes:** (1) – applies only to the recorder version with universal inputs (AR207/8)
(2) – applies only to the recorder version with analog inputs (AR207/16A, AR207/16U and AR207/8A8U)
(3) – applies only to the recorder version with pulse inputs (AR207/8P and AR207/4P4)
(4) – applies only to measurement channel number CN=0÷3 (inputs 1÷4) for recorder version AR207/4P4
(5) – applies only to measurement channel number CN=4÷7 (inputs 5÷8) for recorder version AR207/4P4

21. USER'S NOTES