

Panasonic

System Controller Operating Instructions

Model No. **WV-CU161C**

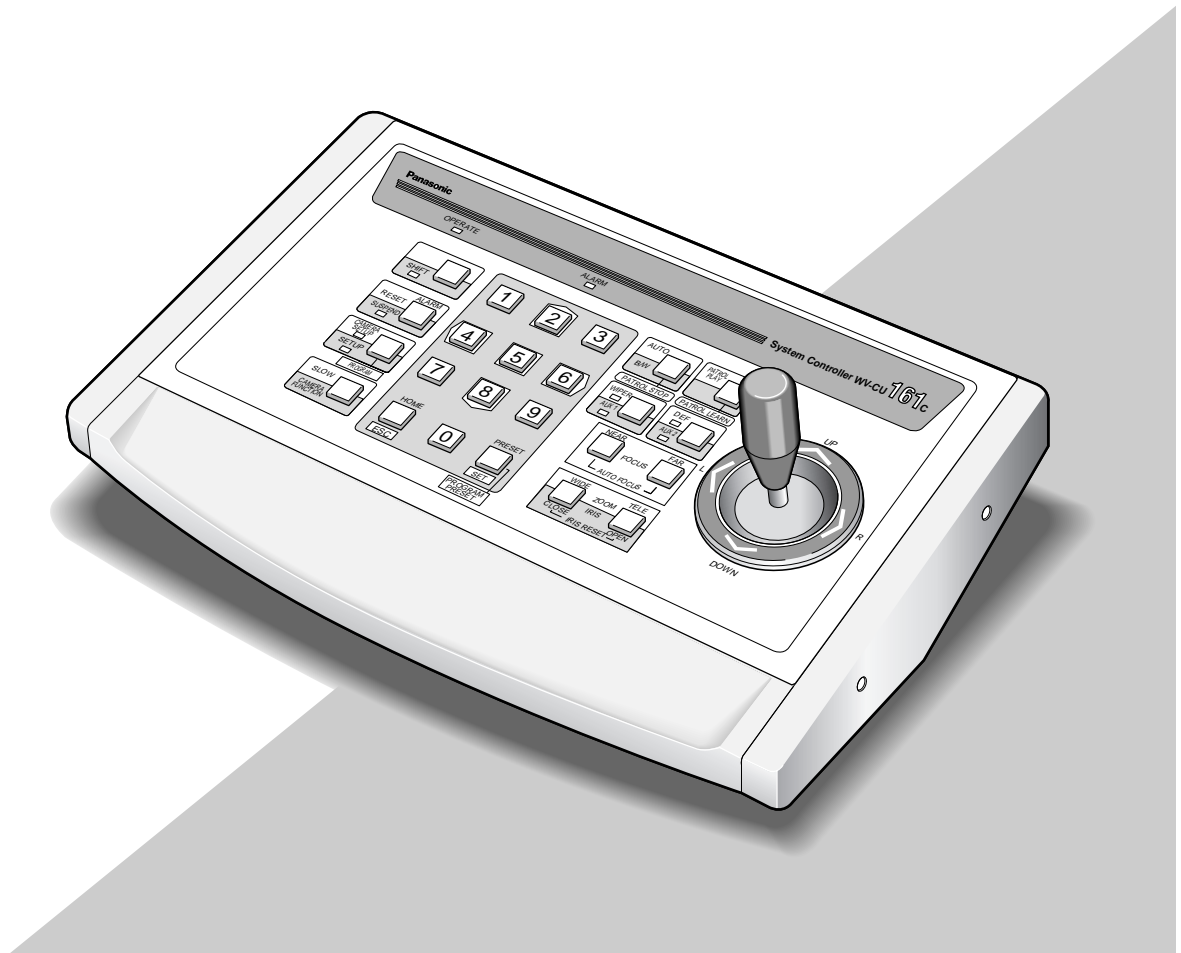

Before attempting to connect or operate this product,
please read these instructions carefully and save this manual for future use.

ENGLISH VERSION

Caution:

Before attempting to connect or operate this product, please read the label on the bottom.

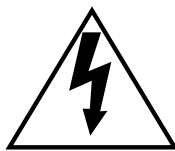
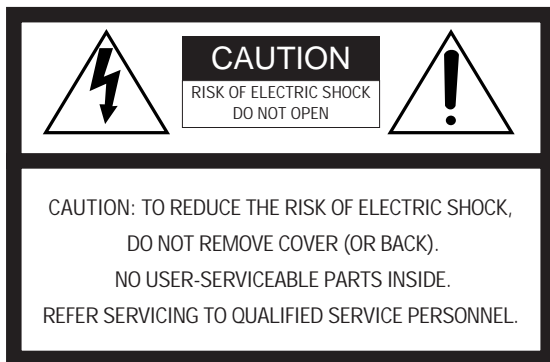

SA 1965

The lightning flash with arrowhead symbol, within an equilateral triangle, is intended to alert the user to the presence of uninsulated "dangerous voltage" within the product's enclosure that may be of sufficient magnitude to constitute a risk of electric shock to persons.



SA 1966

The exclamation point within an equilateral triangle is intended to alert the user to the presence of important operating and maintenance (servicing) instructions in the literature accompanying the appliance.

For U.S.A.

NOTE: This equipment has been tested and found to comply with the limits for a Class A digital device, pursuant to Part 15 of the FCC Rules. These limits are designed to provide reasonable protection against harmful interference when the equipment is operated in a commercial environment. This equipment generates, uses, and can radiate radio frequency energy and, if not installed and used in accordance with the instruction manual, may cause harmful interference to radio communications.

Operation of this equipment in a residential area is likely to cause harmful interference in which case the user will be required to correct the interference at his own expense.

FCC Caution: To assure continued compliance, (example - use only shielded interface cables when connecting to computer or peripheral devices). Any changes or modifications not expressly approved by the party responsible for compliance could void the user's authority to operate this equipment.

The serial number of this product may be found on the bottom of the unit.

You should note the serial number of this unit in the space provided and retain this book as a permanent record of your purchase to aid identification in the event of theft.

Model No. _____

Serial No. _____

WARNING:

To reduce the risk of fire or electric shock, do not expose this appliance to rain or moisture.

IMPORTANT SAFETY INSTRUCTIONS

- 1) Read these instructions.
- 2) Keep these instructions.
- 3) Heed all warnings.
- 4) Follow all instructions.
- 5) Do not use this apparatus near water.
- 6) Clean only with dry cloth.
- 7) Do not block any ventilation openings. Install in accordance with the manufacturer's instructions.
- 8) Do not use near any heat sources such as radiators, heat registers, stoves or other apparatus (including amplifiers) that produce heat.
- 9) Do not defeat the safety purpose of the polarized or grounding-type plug. A polarized plug has two blades with one wider than the other. A grounding-type plug has two blades and a third grounding prong. The wide blade or the third prong are provided for your safety. If the provided plug does not fit into your outlet, consult an electrician for replacement of the obsolete outlet.
- 10) Protect the power cord from being walked on or pinched particularly at plugs, convenience receptacles and the points where they exit from the apparatus.
- 11) Only use attachments/accessories specified by the manufacturer.
- 12) Use only with the cart, stand, tripod, bracket or table specified by the manufacturer or sold with the apparatus. When a cart is used, use caution when moving the cart/apparatus combination to avoid injury from tip-overs.



- 13) Unplug this apparatus during lightning storms or when unused for long periods of time.
- 14) Refer all servicing to qualified service personnel. Servicing is required when the apparatus has been damaged in any way, such as power-supply cord or plug is damaged, liquid has been spilled or objects fallen into the apparatus, the apparatus has been exposed to rain or moisture, does not operate normally, or has been dropped.

CONTENTS

IMPORTANT SAFETY INSTRUCTIONS	3
FEATURES	5
PREFACE	5
PRECAUTIONS	6
MAJOR OPERATING CONTROLS AND THEIR FUNCTIONS	7
■ Front View	7
■ Rear View	9
INSTALLATION	10
■ Mounting in the Rack	10
CONNECTION & SETTING	11
■ System Connection	11
■ Connection with a Time Lapse VCR	14
■ Cable-loss Compensation Setting	14
■ RS-485 Connection	15
■ Switch Setting	16
SETUP MENU	19
■ Displaying the Setup Menu	19
■ Buttons & Controls used in Setup Menu	19
■ Alarm Setup	20
■ System Setup	22
■ Preset Data Loading	22
■ Communication Setup	25
OPERATING PROCEDURES	26
CAMERA CONTROL FUNCTIONS	26
■ Pan/Tilt Control	26
■ Lens Control	26
■ Operation of Combination Camera	27
■ Camera Housing Control	30
■ External Device Control	30
ALARM CONTROL FUNCTIONS	31
■ Alarm Operation	31
■ Alarm Reset	31
■ Alarm Suspend	31
CAMERA SETUP	32
ALL RESET	34
SPECIFICATIONS	35

PREFACE

The WV-CU161C System Controller is designed for one-to-one use with a Combination Camera or WV-RC100/WV-RC150 Receiver that is provided with camera control functions. You can operate the pan/tilt head, lens and patrol play function from the controller in normal operations. The camera setup upload/download and other functions are also available on the setup menus. The distance between the camera and controller may vary depending on the system. The controller can transmit camera control commands via an RS-485 line or a coaxial cable. A time lapse VTR (VCR), alarm sensors and a video monitor can be connected to the controller.

FEATURES

The WV-CU161C offers the following features when used with a combination camera.

- Pan/tilt control: Manual Pan/Tilt Slow ON/OFF, Auto Panning ON/OFF, Sequence Sort/Random
- Lens control: Iris, Zoom, Focus with Auto-focus
- Preset position memories: Up to 64 positions including HOME
- Patrol: Learning/Play
- Image selection: Color/Black and White
- Alarm control: Suspension ON/OFF, Reset

Note: The WV-CU161C will not perform audio communications even if an audio board is installed in the connected Receiver.

PRECAUTIONS

- **Refer all work related to the installation of this product to qualified service personnel or system installers.**
- **Do not block the ventilation opening or slots on the cover.**

Place the appliance at least 5 cm (2 inches) away from the wall to prevent the appliance from heating up.
- **Do not drop metallic parts through the slots as this could permanently damage the appliance.**

Turn the power off immediately and refer servicing to qualified service personnel if any foreign parts fall through the slots.
- **Do not attempt to disassemble the appliance.**

Do not remove any screws or covers as doing so can cause electric shocks.
There are not any user-serviceable parts inside. Refer maintenance to qualified service personnel.
- **Handle the appliance with care.**

Do not strike or shake the appliance as this may damage the appliance.
- **Do not expose the appliance to water or moisture. Do not try to operate it in wet areas.**

Take immediate action if the appliance becomes wet. Turn the power off and refer servicing to qualified service personnel. Moisture can damage the appliance and can also cause electric shocks.
- **Do not use strong or abrasive detergents to clean the outside of the appliance.**

Use a dry cloth to clean the appliance when it is dirty. If the dirt is hard to remove, then use a mild detergent and wipe gently.
- **Do not operate the appliance beyond its specified temperature, humidity or power source ratings.**

Do not use the appliance in an extreme environment where there are high temperatures or high humidity. Use the appliance at temperatures within -10°C and $+50^{\circ}\text{C}$ (14°F to 122°F) and where the humidity below 90 %.
The input power source for this appliance is 120 V AC 60 Hz.

MAJOR OPERATING CONTROLS AND THEIR FUNCTIONS

■ Front View

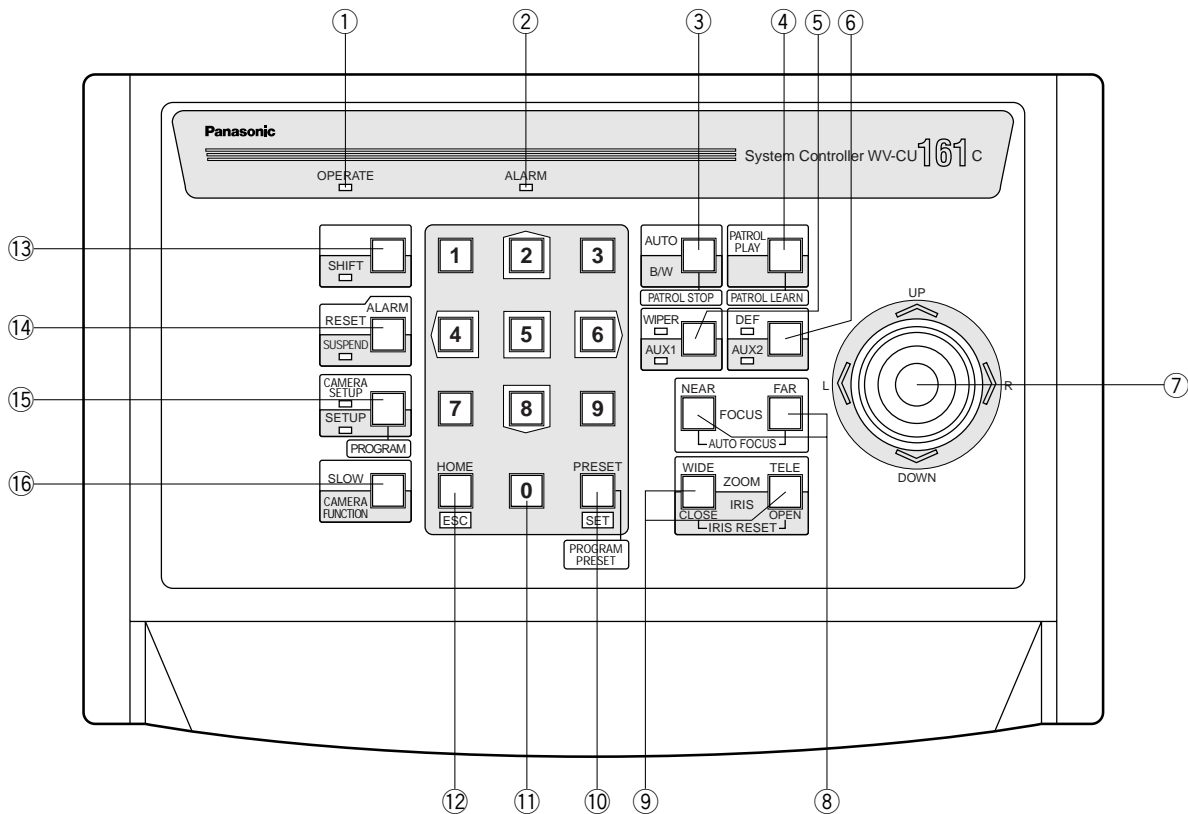

① Operate Indicator (OPERATE)

Lights up while the System Controller power is on.

② Alarm Indicator (ALARM)

Blinks when an alarm is activated.
The blink changes to a steady light when the alarm is automatically reset.
Press the ALARM RESET button to turn the indicator off.

③ Auto Panning/Black and White Selection/Patrol Stop Button (AUTO/B/W/PATROL STOP)

AUTO: Pressing this button will activate the auto panning function of cameras that are provided with this feature.

B/W: Pressing this while the SHIFT indicator is lit will display the picture in black and white on the monitor.

PATROL STOP: Pressing this button while holding down the CAMERA SETUP button will stop programming the camera patrol learning function.

The four following Auto Panning modes can be selected by pressing the AUTO button in combination with buttons 1 to 4

For further information, refer to the Operating Instructions for the individual combination cameras.

AUTO PAN ON or Functions set on a combination camera: Simply press this button or press button 1 and then this button.

AUTO SORT ON: Press button 2 and then this button.

AUTO SEQ ON: Press button 3 and then this button.

RANDOM PAN ON: Press button 4 and then this button.

④ Patrol Play/Patrol Learn Button (PATROL PLAY/ PATROL LEARN)

Pressing this button will start the camera patrol play function. Pressing this button while holding down the CAMERA SETUP button will start to program the camera patrol learning function.

⑤ **Wiper/Auxiliary 1 Button (WIPER/AUX1)**

Pressing this button will turn the housing wipers on or off for cameras provided with this function. Pressing this while the SHIFT indicator is lit will turn on or off the AUX1 function controlling accessories that are connected to the camera or the specified receiver.

The indicator next to the respective button is lit while the wiper or AUX1 operates.

⑥ **Defroster/Auxiliary 2 Button (DEF/AUX2)**

Pressing this button will turn the housing defroster on or off for cameras provided with this function. Pressing this while the SHIFT indicator is lit will turn on or off the AUX2 function controlling accessories that are connected to the camera or the specified receiver.

The indicator next to the respective button is lit while the defroster or AUX2 operates.

⑦ **Joystick Controller (UP/DOWN/L/R)**

This joystick manually operates the Pan/Tilt Head and moves the cursor in the Setup menu on the monitor screen.

UP: Upward
DOWN: Downward
L: Left
R: Right

⑧ **Focus Buttons (FOCUS: NEAR/FAR)**

These buttons are used to adjust the lens focus of cameras equipped with the specified lens.

When these buttons are pressed simultaneously, the lens focus is set automatically when the specified camera is used.

⑨ **Zoom/Iris Buttons**

(ZOOM: WIDE/TELE, IRIS: CLOSE/OPEN)

These buttons are used to zoom the camera image in (TELE) and out (WIDE).

The lens iris is adjusted by pressing the OPEN or CLOSE button while the SHIFT indicator is lit. Hold down these buttons simultaneously for 1 second while the SHIFT indicator is lit in order to reset the iris back to the factory setting.

⑩ **Preset/Set/Program Preset Button (PRESET/SET/PROGRAM PRESET)**

PRESET: This button is used combined with the numeric buttons to move a specific camera to a preset position.

SET: This button is used to execute the currently highlighted setting in the Setup menu.

PROGRAM PRESET: Pressing this while holding down the CAMERA SETUP/SETUP/PROGRAM button will program a preset position.

⑪ **Numeric Buttons (0-9)**

These buttons are used for the numeric input of preset numbers and for executing parameters on the Camera Setup menu.

⑫ **Home/Escape Button (HOME/ESC)**

HOME: This button is used to return a specific camera to the home position.

ESC: This button is used to escape from the currently highlighted selection and return to the previous menu of the Setup Menu.

⑬ **Shift button (SHIFT)**

Pressing this button will enter or quit the shift mode. While the SHIFT indicator is lit, press or hold down a button that is assigned to a special function in the shift mode in order to activate or deactivate the function.

⑭ **Alarm Reset/Suspend Button (ALARM RESET/SUSPEND)**

Pressing this button while the alarm function is activated will reset the system alarm.

Pressing this button while the SHIFT indicator is lit will activate or deactivate the alarm suspension mode.

The LED next to the button is lit while the alarm suspension mode operates.

⑮ **Camera Setup/Setup/Program Button (CAMERA SETUP/SETUP/PROGRAM)**

Pressing this button for 2 seconds or more will open or close the Camera Setup menu.

Pressing this button for 2 seconds or more while the SHIFT indicator is lit will open or close the controller setup menu. The indicator next to the respective button is lit while the setup window is operated.

This button is also used to program the camera patrol learning and preset position functions.

⑯ **Slow/Camera Function Button (SLOW/CAMERA FUNCTION)**

The pan/tilt speed will decrease if this button is pressed while the joystick controller is moved.

Pressing this combined with the numeric buttons while the SHIFT indicator is lit will execute the camera functions.

■ Rear View

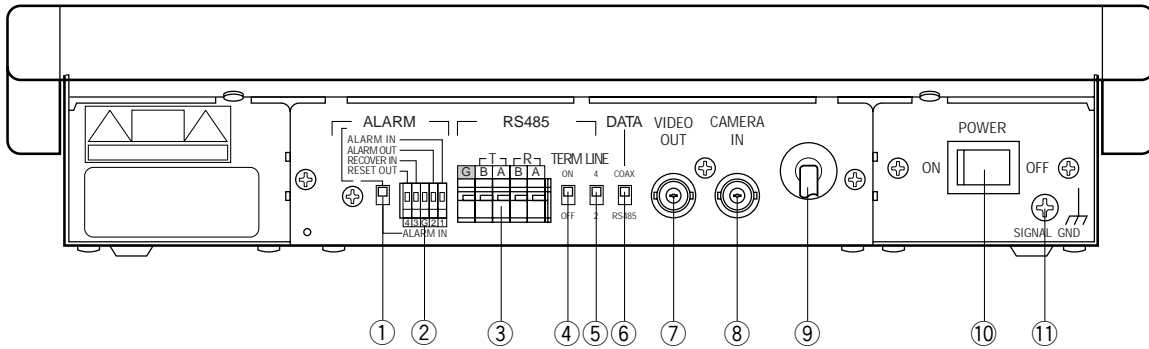

① Alarm Switch

This switch is used to specify the functions for the 5-pin terminal adjacent to the switch. When the switch is set to the upper position, the terminals supply and accept the alarm related signals with a Time Lapse VCR. When the switch is in the lower position, the terminals accept alarm inputs 1, 2, 3 and 4.

② Alarm Terminals

Terminal functions are specified by the alarm switch position as shown in the table. Refer to page 14 for connection with a Time Lapse VCR.

Pin #	Switch Position	
	Up	Down
1	Alarm Input	Alarm Input 1
2	Alarm Output	Alarm Input 2
G	Signal ground	Signal ground
3	Recover Input	Alarm Input 3
4	Reset Output	Alarm Input 4

③ RS-485 Terminal

This terminal is used to exchange control data with the camera site.

④ Termination Switch (TERM ON/OFF)

This switch is used to terminate the RS-485 communication lines.

It should normally be kept in the ON position.

⑤ Line Selection Switch (LINE 4/2)

This switch is used to select full-duplex (4-lines) or half-duplex (2-lines) for the communication lines.

⑥ Data Selection Switch (DATA COAX/RS485)

This switch selects the data communication route from among the multiplexing data on a coaxial cable or when using an RS-485 line.

⑦ Video Output Connector (VIDEO OUT)

This connector supplies composite video signals from the camera.

⑧ Camera Input Connector (CAMERA IN)

This connector accepts the multiplexed video and control data signals from the specified camera or a specified receiver.

⑨ AC Cord

⑩ Power Switch (POWER)

This switch is used to turn the System Controller power on and off.

Caution: In the following cases, disconnect the AC cord from the service outlet, or switch off an ALL-POLE MAIN SWITCH with a contact separation of at least 3 mm in each pole incorporated in the electrical insulation of the building.

This is to be used when the controller needs to be isolated from the AC mains, when the controller will not be used for a long time, and when there is lightning.

⑪ Signal Ground Terminal (SIGNAL GND)

INSTALLATION

CAUTION

- Installation should be performed by qualified service personnel or system installers according to the following instructions.
- Disconnect the power cord from the service outlet before installation.

■ Mounting in the Rack

1. Remove the Connector Panel and Bottom Cover from the controller by removing the four screws.
2. Mount the Connector Panel onto the bottom by using the two screws that were removed above.
3. Mount the Bottom Cover onto the rear by using the two screws that were removed above.
4. Remove the side panels by removing the four screws.
5. Remove the Palm Rest Panel by removing the two screws.
6. Fix the Rack Mounting Angles onto both sides by using the four screws.
7. Mount the controller in the EIA standard 19-inch rack.

Note: Always keep the temperature in the rack within 45°C (122°F).

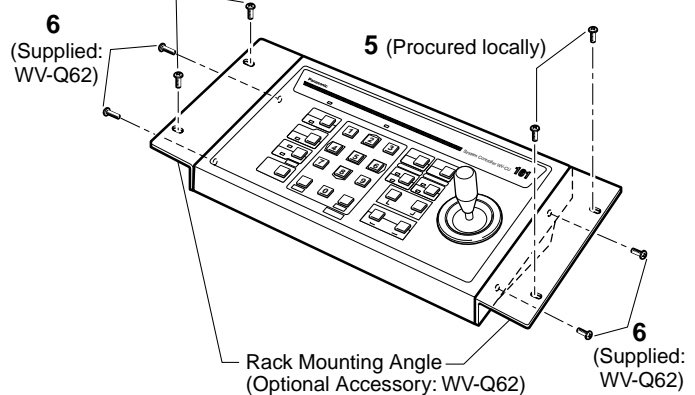
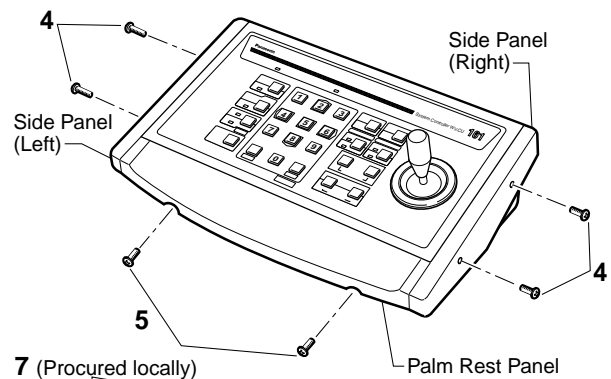
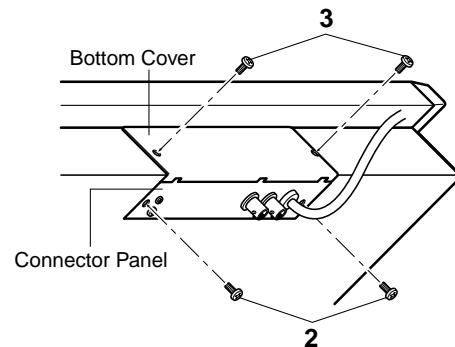
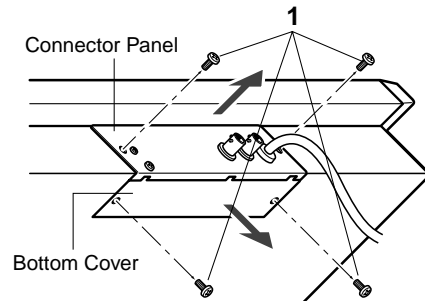

CONNECTION & SETTING

■ System Connection

● Basic Connection

The WV-CU161C can be connected with a camera, a Time Lapse VCR and a video monitor as in the typical system configuration shown below.

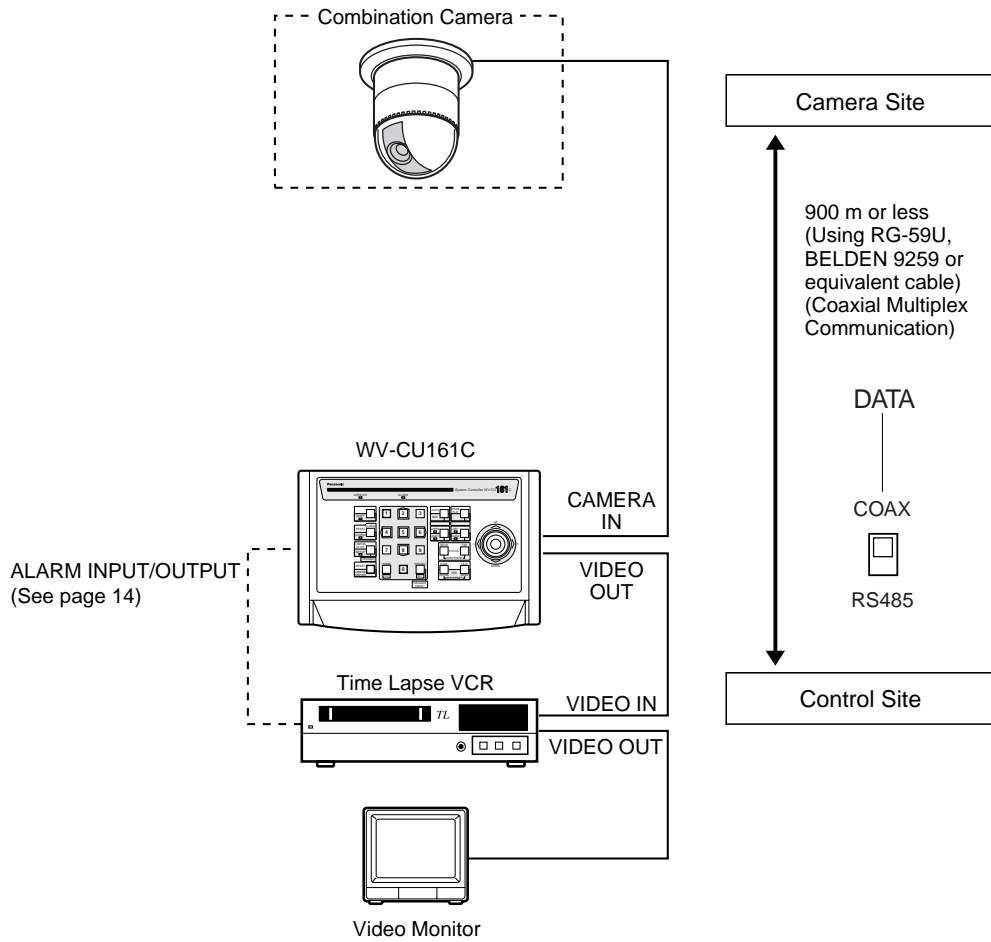

Note: Refer to the operating instructions of each system component for connection and operation.

● Connecting more Cameras

A bi-directional video switcher purchased separately can be installed when connecting more than one camera. Video signal reception, camera control and alarm input reception are only available between the camera selected and the controller due to the nature of the switcher.

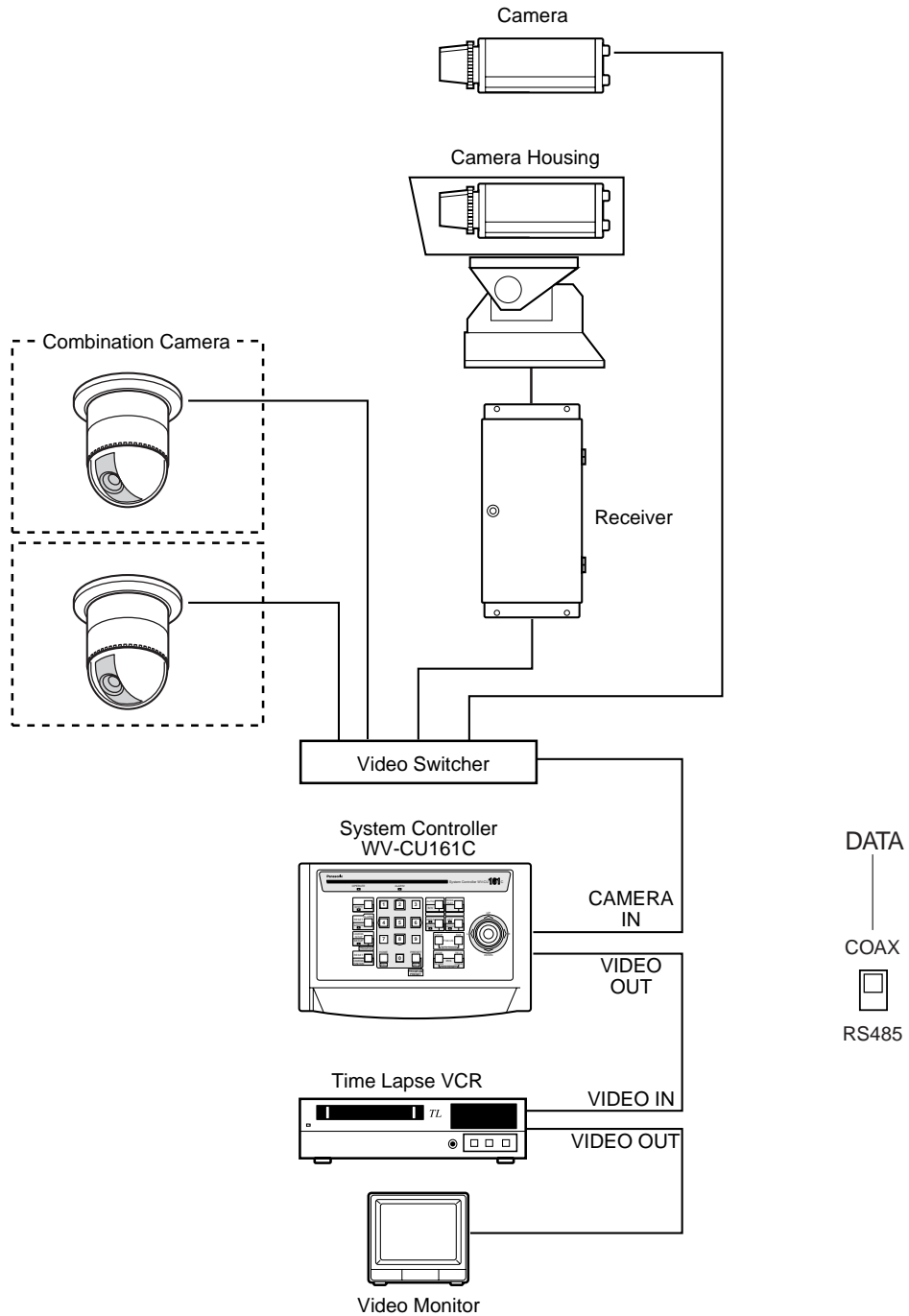

Note: Refer to the operating instructions of each system component for connection and operation.

● Connecting with a Distant Camera Site

Using two Network Interface Units, that is a Transmitter and a Receiver, will help to extend the distance between the camera and control sites. An RS-485 is used when the communication line is extended for more than 1200 m (400 ft).

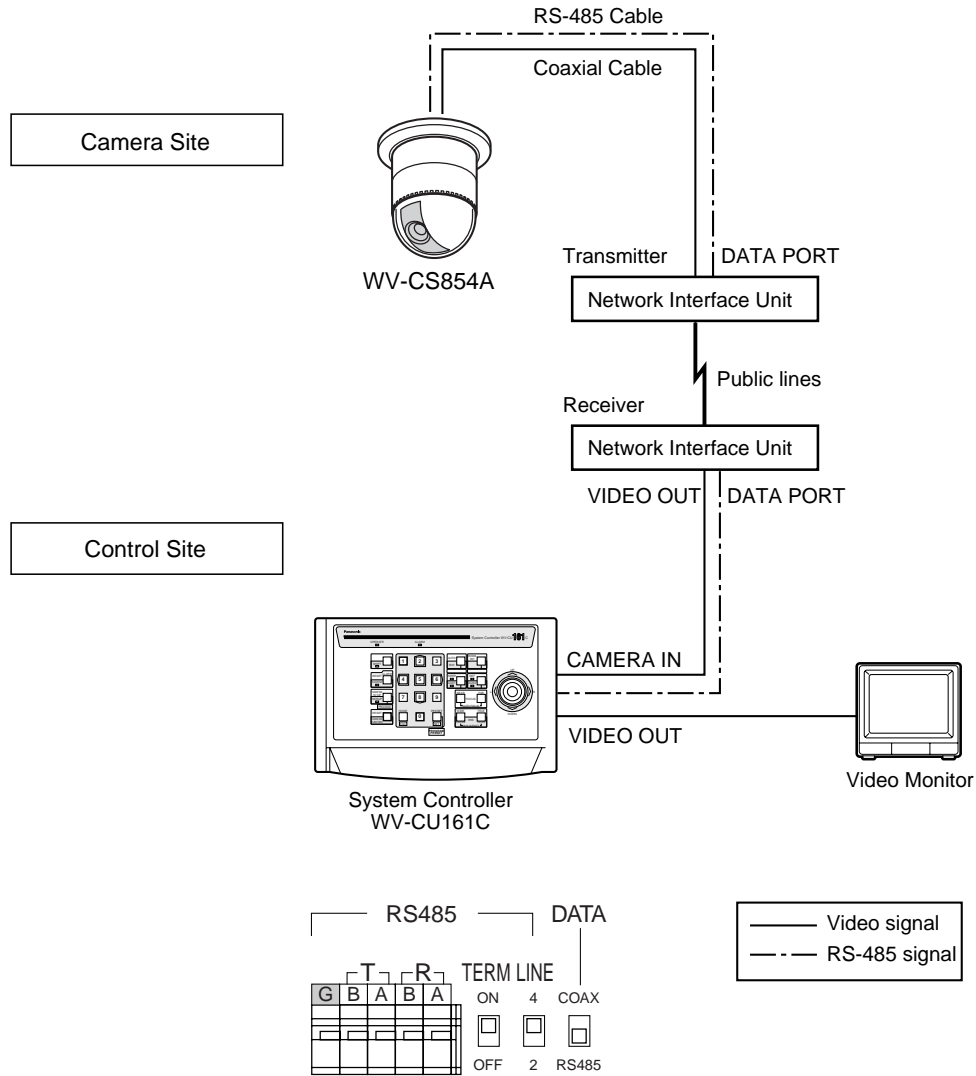

Notes:

- Refer to the operating instructions for each system component for connecting and operating them.
- If the public line is busy, then it may cause instability for the system operation.

■ Connection with a Time Lapse VCR

Alarm in/out and recover-reset in/out are connected between the time lapse VCR and the rear of the controller.

Note: Use a relay as shown below when connecting an indicator such as a buzzer that exceeds 16 V DC 100 mA.

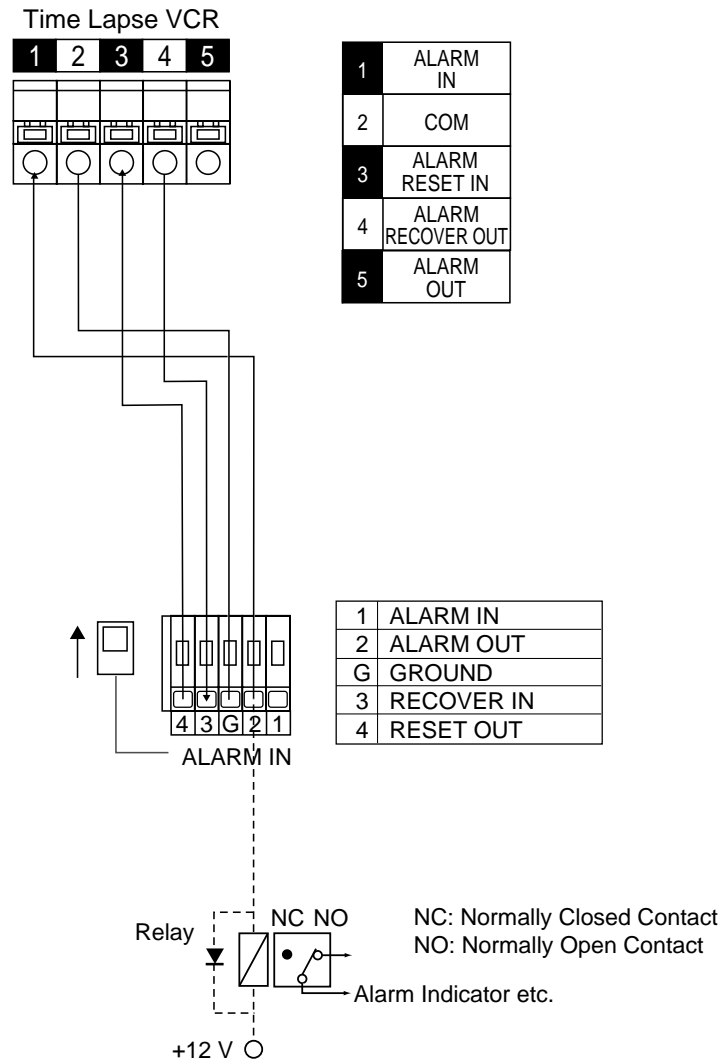

■ Cable-loss Compensation Setting

The maximum allowable cable length between a camera and a controller is 900 m (3 000 ft) when using an RG-59U BELDEN or equivalent cable. Cable loss compensation can be adjusted in the setup menu as S, M or L.

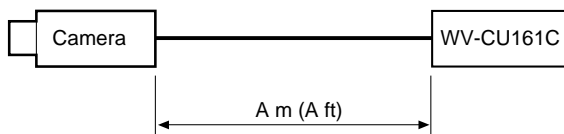

Cable length (with RG-59U BELDEN 9259 or equivalent) Unit: m (ft)	Cable compensation parameter in WV-CU161C Setup menu
0 (0) ≤ A < 400 m (1 300 ft)	→ S
400 (1 300) ≤ A < 700 m (2 300 ft)	→ M
700 (2 300) ≤ A < 900 m (3 000 ft)	→ L

■ RS-485 Connection

Control data is transmitted and received between the controller and other peripherals. Use a shielded cable of data communication grade, consisting of two twisted pairs suitable for RS485. Cable length may be extended up to 1 200 m (4 000 ft).

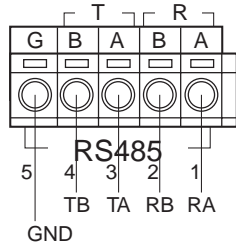

● Internal Diagram

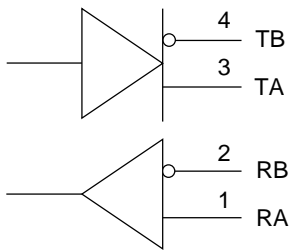

Note: Make sure to turn the DATA switch on the rear of the controller to RS-485 position.

■ Switch Setting

There are four switches on the rear of the controller for specifying the terminal definition and data communication conditions. A signal form selection switch (SW1) and a character display mode switch (SW100) are mounted inside the controller. These inner switches do not need to be adjusted when the controller is used with the factory default settings.

● Rear Panel Setting

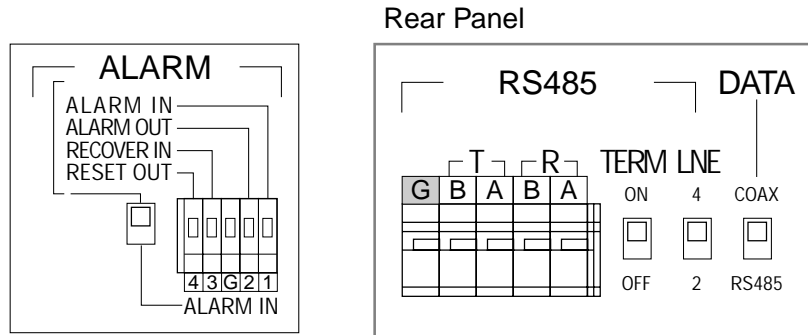

Alarm Terminal Definition Switch

This switch specifies the functions for the 5-pin terminal. The default setting is the upper position.

Upper position: Used when connecting with a Time Lapse VCR. The terminals function as ALARM IN, ALARM OUT, RECOVER IN and RESET OUT.

Lower position: Used when connecting with multiple alarm sensors. The terminals function as ALARM IN 1-4.

Termination Switch

This switch opens or terminates the RS-485 line. The default setting is ON.

ON: Used when connecting one to one. The line is terminated by a 150-ohm resistor.

OFF: The line is open.

Line Switch

This switch specifies the RS-485 communication mode. Match it to the mode used by the connected devices. The default setting is 4.

4: 4-line full duplex

2: 2-line half duplex

Data Switch

This switch specifies the data communication route between the controller and the camera. The default setting is COAX.

COAX: Control commands and status information are transmitted and received through a coaxial cable.

RS485: Commands and status are transmitted and received through an RS-485 cable connected to the RS-485 terminal.

● Internal Switch Setting

Caution:

- The internal switch setting should be performed by qualified service personnel or system installers.
- Unplug the controller power cord from the electric outlet before setting the internal switch in order to reduce the risk of electric shocks.

The internal switches, SW1 and SW100, can be readjusted to change the recover output signal form or character display mode from the default settings.

Recover Output Switch (SW1)

1. Remove the bottom cover by removing the two screws.
The SW1 mounted inside the controller can be seen.
2. Set the SW1 to the desired position. The default setting is 0/5V.

0/5V: 0V or 5V output, active when it is 5 V.

O.C: Open collector output, active when it is low.
Control capacity is 16 V 500 mA maximum.

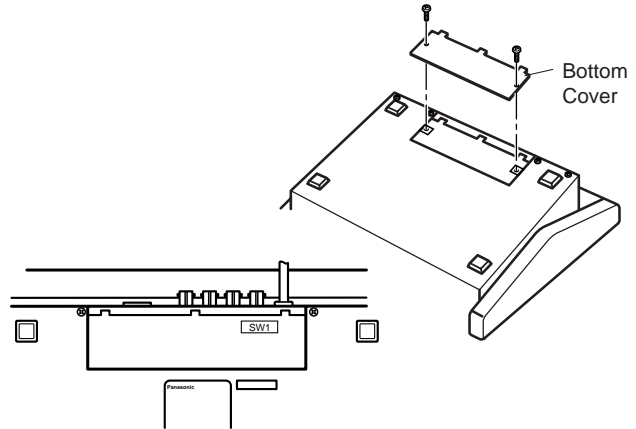
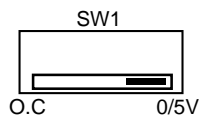

3. Place the bottom cover as it was before and fasten the two screws.

Display mode Switch (SW100)

1. Remove the bottom cover as described above.
2. Remove the two side panels and the bottom panel by removing the twelve screws. The SW100 mounted inside the controller can be seen.

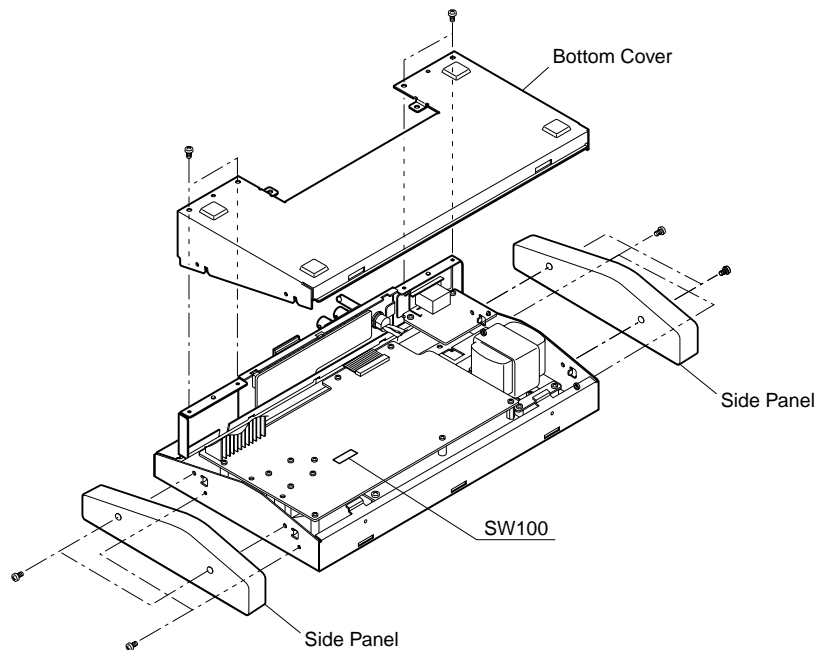

3. Set the SW100 to the desired position. The default setting is NOR.

NOR: White letters are displayed with a black border.

REV: Black letters are displayed with a white border.

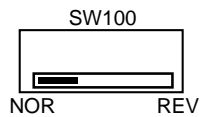

4. Place the side panels, bottom panel and bottom cover in their previous positions and fasten the screws that were previously removed.

SETUP MENU

The SETUP MENU has four main submenus: Alarm Setup, System Setup, Preset Data Load and Communication. All of these main menus are further divided into submenus.

SETUP MENU

- ALARM SETUP Page 20
- SYSTEM SETUP Page 22
- PRESET DATA LOAD Page 22
- COMMUNICATION Page 25

■ Displaying the Setup Menu

1. Check that the camera, monitor and peripherals are correctly and securely connected.
2. Switch all the system components on.
The operation indicator of the WV-CU161C lights up, and the picture of the camera appears on the monitor.
3. Press the CAMERA SETUP/SETUP/PROGRAM button for 2 seconds or more while the SHIFT indicator is lit.
4. The SETUP MENU appears.

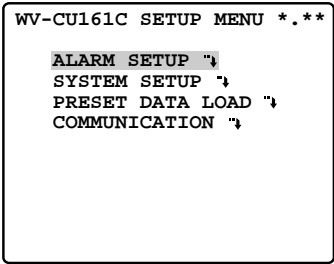

Note: The COMMUNICATION parameter appears when the DATA switch is set to RS-485 (See page 16).

■ Buttons & Controls used in the Setup Menu

SHIFT button + CAMERA SETUP/SETUP/PROGRAM button:

Press the CAMERA SETUP/SETUP/PROGRAM button for 2 seconds or more while the SHIFT indicator is lit.

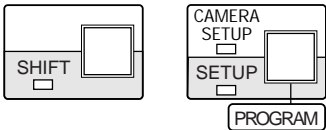

PRESET/SET/PROGRAM PRESET button:

Press this button to confirm the parameter selection or to enter a submenu for an item marked with "↵".

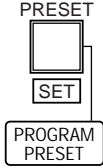





HOME/ESC button:

Press this button to return to the previous menu.

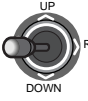

• Joystick Controller

-  Up: To select a setup item.
-  Down: To select a setup item.
-  Left: To decrease the parameter.
-  Right: To increase the parameter.

• Closing Setup Menu

Press the PRESET/SET/PROGRAM PRESET button for 2 seconds or more while the SHIFT indicator is lit. The SETUP indicator goes off.

Note: The new settings are not saved if the WV-CU161C power is turned off before completing the setup. Return to the WV-CU161C SETUP MENU, complete the setup, and then turn the power off to save the new settings.

■ Alarm Setup

Alarm related functions are set up.

1. Display the WV-CU161CC SETUP MENU.
2. Move the cursor to ALARM SETUP \rightarrow , and then press the SET button.

The setup menu appears depending on the ALARM switch setting on the rear of the controller.

ALARM PRESET appears on the bottom of the menu when the ALARM switch is set to the upper position to connect with a time lapse VCR.

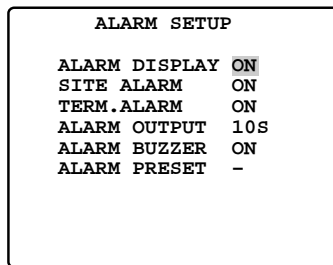

ALARM TERMINAL \rightarrow appears on the bottom of the menu when the ALARM switch is set to the lower position to connect with four sensors.

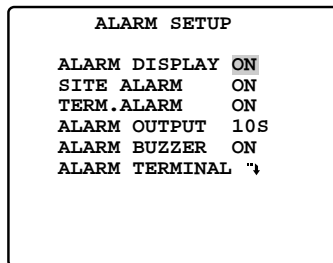

Alarm Display Setting

This item lets you select whether or not to display an "ALARM" text line on the monitor when an alarm is activated.

1. Display the ALARM SETUP menu.
2. Move the cursor to ALARM DISPLAY.
3. Select ON or OFF using the joystick, and then press the SET button. The factory setting is ON.

ON: Display is enabled.

OFF: Display is disabled.

Note: The display time differs depending on the Alarm Output Setting.

Site Alarm Setting

This item lets you enable or disable the controller to receive the camera site alarm.

1. Display the ALARM SETUP menu.
2. Select SITE ALARM by moving the joystick up or down.
3. Select SITE ALARM ON or OFF by moving the joystick to the right or left.

The initial factory setting is ON.

ON: The controller receives the site alarm (Video Motion Detection: VMD) issued by the camera.

OFF: The site alarm is disabled.

Terminal Alarm Setting

This item lets you enable or disable the controller to receive the alarm signal from the alarm connector.

1. Display the ALARM SETUP menu.
2. Select TERM.ALARM by moving the joystick up or down.
3. Select TERM.ALARM ON or OFF by moving the joystick to the right or left.

The initial factory setting is ON.

ON: Alarm activation through the terminal is received.

OFF: Alarm activation through the terminal is not received.

Alarm Output Setting

This item lets you select the duration that the following three functions continue working for after an alarm activation.

- The ALARM is displayed on the monitor (ALARM DISPLAY ON mode).
- The alarm is output to external devices (from the ALARM OUTPUT connector).
- The buzzer sounds (ALARM BUZZER ON mode).

1. Display the ALARM SETUP menu.
2. Select ALARM OUTPUT by moving the joystick up or down.
3. Select the desired alarm output duration of 1S-30S, 40S, 50S, 1MIN, 2MIN, 3MIN, 4MIN, 5MIN EXT or OFF by moving the joystick to the right or left.

The initial factory setting is 10S.

EXT: The alarm signal continues to be output from the alarm output connector until the alarm is reset. The alarm is not automatically reset.

1S-5MIN: The alarm signal is only supplied from the alarm output connector for the set time. The alarm is automatically reset after the set time. The ALARM indicator changes from blinking to a steady light.

OFF: No alarm output signal is supplied. (The alarm is deactivated.)

Alarm Buzzer Setting

This item lets you select whether or not to sound the alarm buzzer when an alarm is activated.

1. Display the ALARM SETUP menu.
2. Select ALARM BUZZER by moving the joystick up or down.
3. Select ALARM BUZZER ON or OFF by moving the joystick to the right or left.

The initial factory setting is ON.

Note: The alarm buzzer time differs depending on (4) alarm output setting.

Alarm Preset Position Setting

This item lets you preset a camera position to an alarm input. The camera will move its pan/tilt head to the position when the alarm operates.

- The menu below appears when the ALARM switch on the rear of the controller is set to the upper position to connect with a Time Lapse VCR.

ALARM SETUP	
ALARM DISPLAY	ON
SITE ALARM	ON
TERM.ALARM	ON
ALARM OUTPUT	10S
ALARM BUZZER	ON
ALARM PRESET	-

1. Display the ALARM SETUP menu.
2. Select ALARM PRESET by moving the joystick up or down.
3. Move the joystick to the right or left to select the desired preset numbers of the picture on the monitor in the range from 1-64 or [-] if no preset numbers are assigned.
The initial factory setting is - (No assignment).

1-64: Preset numbers

-: No assignment

Note: ALARM PRESET is only available when a combination camera is connected.

Alarm Terminal

The menu below appears when the ALARM switch on the rear of the controller is set to the lower position to receive the four sensor inputs.

ALARM SETUP	
ALARM DISPLAY	ON
SITE ALARM	ON
TERM.ALARM	ON
ALARM OUTPUT	10S
ALARM BUZZER	ON
ALARM TERMINAL	"↓"

1. Display the ALARM SETUP menu.
2. Select ALARM TERMINAL by moving the joystick up or down.
3. Press the PRESET/SET/PROGRAM PRESET button.
The ALARM TERMINAL menu opens.

ALARM TERMINAL	
ALARM	PRESET
1	▣
2	-
3	-
4	-

4. Select the alarm terminal number by moving the joystick up or down.
5. Move the joystick to the right or left to select the desired preset numbers.
The initial factory setting is - (No assignment).

1-64: Preset numbers

-: No assignment

6. Press the HOME/ESC button to return to the previous menu.

Notes:

- ALARM TERMINAL is only available when a combination camera is connected.
- If the camera has the Preset Alarm ON/OFF mode, then set it to OFF.

■ System Setup

1. Display the WV-CU161C SETUP MENU.
2. Select SYSTEM SETUP by moving the joystick up or down.
3. Press the PRESET/SET/PROGRAM PRESET button.
The SYSTEM SETUP menu appears on the monitor.

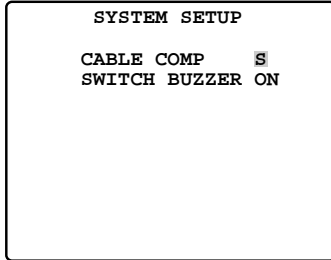

Cable Compensation Setting

This item lets you select a compensation level to match to transmission loss caused by cable extension.

1. Display the SYSTEM SETUP menu.
2. Select CABLE COMP by moving the joystick up or down.
3. Select the most appropriate cable length by moving the joystick to the right or left.
The initial factory setting is S.

S: Less than 400 m (1 300 ft)

M: 400 m (1 300 ft) to 700 m (2 300 ft)

L: 700 m (2 300 ft) to 900 m (3 000 ft)

(When using RG-59U, BELDEN 9259 or equivalent cable)

Switch Buzzer Setting

This item lets you select whether or not to sound the switch buzzer when a button is pressed.

1. Display the SYSTEM SETUP menu.
2. Select SWITCH BUZZER by moving the joystick up or down.
3. Select the ON or OFF mode by moving the joystick to the right or left.
The initial factory setting is ON.

■ Preset Data Loading

The data settings preset to the camera are downloaded to the controller. A set of preset data can be given a title by the controller operation. The preset data with the title can be uploaded to other cameras.

1. Display the WV-CU161C SETUP MENU.
2. Select PRESET DATA LOAD by moving the joystick up or down.
3. Press the PRESET/SET/PROGRAM PRESET button.
The PRESET DATA LOAD screen appears on the monitor as shown below.

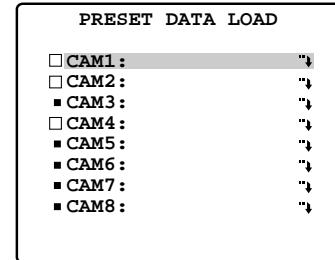

: Data saved.

: No Data saved. (The factory default setting for all cameras from CAM1 to CAM8 is)

Downloading

1. Display the PRESET DATA LOAD menu.
2. Select a camera number between CAM1 and CAM8 by moving the joystick up or down.
3. Press the PRESET/SET/PROGRAM PRESET button.
The camera number and download menu appear on the monitor as shown below.

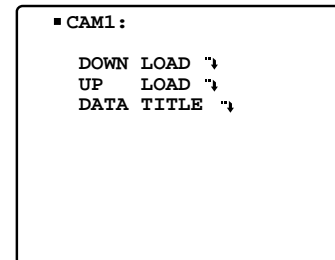

4. Select DOWN LOAD by moving the joystick up or down.
5. Press the PRESET/SET/PROGRAM PRESET button.
Downloading starts.

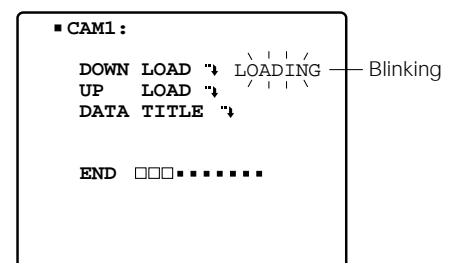

6. The text line **LOADING** blinks on the right while downloading.
The bar graph changing from ■ to □ displays the downloading progress.
7. **END** appears on the right after downloading has been completed. The progress bar disappears.
8. Editing the **DATA TITLE**.
For further information, refer to Data Title on the next page.

Notes:

- Preset data for up to 8 cameras can be downloaded.
- Downloading time is approximately 2 minutes per camera.
- Any previously preset data is overwritten by the downloaded data.
- Press the HOME/ESC button while downloading to terminate downloading. **ERROR 3** appears. The progress bar disappears.
- **END** and error messages remain on the menu until the next operation is performed.
- Check that the right unit address is selected for the combination camera when the RS-485 mode is used. If the numbers do not agree, the camera cannot be operated.
Therefore, preset data cannot be downloaded.

• **Error Display**

The following messages appear on the monitor when an error occurs during downloading.

Message	Cause	Note
ERROR 2	Lack of memory	Memory capacity was exceeded while downloading.
ERROR 3	Causes except above	Downloading not possible for some reason other than the above.

Uploading

1. Display the **PRESET DATA LOAD** menu.
2. Select a camera number between **CAM1** and **CAM8** by moving the joystick up or down.
3. Press the **PRESET/SET/PROGRAM PRESET** button.
The camera number and upload menu appear on the monitor as shown below.

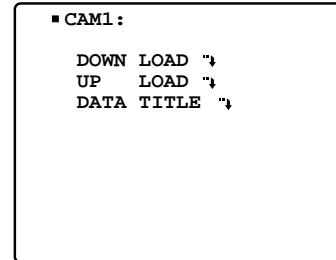

4. Select **UP LOAD** by moving the joystick up or down.
5. Press the **PRESET/SET/PROGRAM PRESET** button.
Uploading starts.

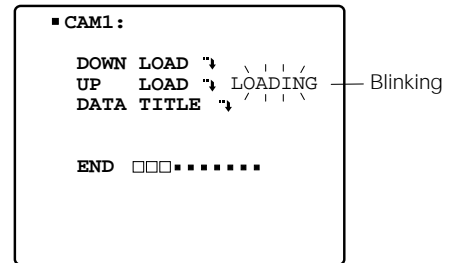

6. The text line **LOADING** appears on the right while uploading.
The bar graph changing from ■ to □ displays the uploading progress.
7. **END** appears on the right after the uploading has been completed. The progress bar disappears.

Notes:

- Preset data for up to 8 cameras can be uploaded.
- The uploading time is approximately 2 minutes per camera. When uploading is completed, combination cameras such as the WV-CS854 will move during the initial periods to fit the new settings.
- The camera picture may change as a result of uploaded data. Access the Camera Setup menu to make any necessary settings.
- Any previous preset data is overwritten by the uploaded data.
- Press the HOME/ESC button to terminate uploading. **ERROR 3** appears and the progress bar disappears.
- **END** and error messages remain on the menu until the next operation is performed.

- Check that the right unit address is selected for the combination camera when using the RS-485 mode. The camera cannot be operated if the numbers do not agree. Therefore, preset data cannot be uploaded.

• Error Display

The following messages appear on the monitor when errors occur during uploading.

Message	Cause	Note
ERROR1	Incompatibility	Incompatibility detected between transmission data and camera model while uploading.
ERROR 3	Causes except above	Uploading not possible for some reason other than the above.

Data Title

1. Display the PRESET DATA LOAD menu.
2. Select the desired CAM1-CAM8 position by moving the joystick up or down.
3. Press the PRESET/SET/PROGRAM PRESET button. The camera number and data title menu appear on the monitor as shown below.

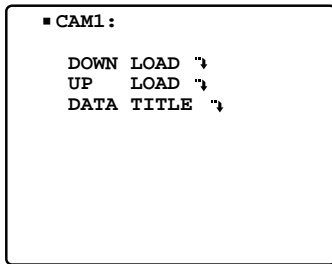

4. Select DATA TITLE by moving the joystick up or down. Press the PRESET/SET/PROGRAM PRESET button. The menu shown below appears on the monitor.

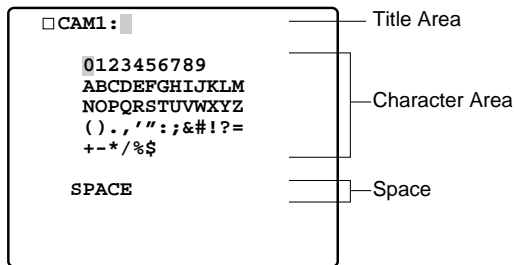

5. Move the cursor to the desired character symbol in the character symbol area by moving the joystick up, down, right or left, and then pressing the PRESET/SET/PROGRAM PRESET button. The selected character is displayed in the title area.

6. Repeat step 5 to complete the data title. A title of up to 12 characters can be selected.

7. After setting all data titles, press the HOME/ESC button to return to the Preset Data Menu.

To replace a specific character

1. Move the cursor to the title area by moving the joystick.
2. Move the cursor on the character to be replaced by moving the joystick right or left.
3. Move the cursor from there to the desired character in the character area by moving the joystick up or down, and move the cursor to the desired character by moving the joystick up, down, right or left.
4. Press PRESET/SET/PROGRAM PRESET button. The character selected in the title area is replaced with the correct character.

To delete a specific character

A specific character can be deleted by selecting "SPACE" to replace it in the character area.

1. Move the cursor to the title area by moving the joystick.
2. Move the cursor on the character to be deleted by moving the joystick right or left.
3. Move the cursor from there to "SPACE" in the character area by moving the joystick up or down.
4. Press the PRESET/SET/PROGRAM PRESET button. The character selected in the title area is deleted. [•] (space mark) appears in place of the deleted character.

■ Communication Setup

Note: The COMMUNICATION menu appears when the DATA switch is set to RS-485.

COMMUNICATION	
UNIT ADDRESS	1
BAUD RATE	19200
DATA BIT	8
PARITY CHECK	NONE
STOP BIT	1
WAIT TIME	OFF
DELAY TIME	OFF
XON/XOFF	NOT USE

Unit Address

This item lets you set the unit address assigned to the camera for RS-485 communication. Be sure to confirm the camera unit address before setting up this item.

1. Display the COMMUNICATION menu.
2. Select UNIT ADDRESS by moving the joystick up or down.
3. Select the unit address assigned to the combination camera in the range from 1 to 96 by moving the joystick to the right or left.

The initial factory setting is 1.

Note: The camera cannot be operated if an address different from that set on the camera is selected.

Baud Rate

This item lets you set the baud rate for RS-485 communication.

1. Display the COMMUNICATION menu.
2. Select BAUD RATE by moving the joystick up or down.
3. Select 19200, 9600, 4800 or 2400 bps for the baud rate by moving the joystick to the right or left.

The initial factory setting is 19200 bps.

Notes:

- The data response may be unstable at the baud rate of 2400 bps for some functions such as resetting alarms.
- This setting must be compatible with the peripherals connected.

Data Bit

This item lets you set the number of data bits for RS-485 communication.

1. Display the COMMUNICATION menu.
2. Select DATA BIT by moving the joystick up or down.
3. Select 7 or 8 bits for the number of data bits by moving the joystick to the right or left.

The initial factory setting is 8 bits.

Note: This setting must be compatible with the peripherals connected.

Parity Check

This item lets you set the parity check mode for RS-485 communication.

1. Display the COMMUNICATION menu.
2. Select PARITY CHECK by moving the joystick up or down.
3. Select NONE, EVEN or ODD for the parity check by moving the joystick to the right or left.

The initial factory setting is NONE.

Note: This setting must be compatible with the peripherals connected.

Stop Bit

This item lets you set the number of stop bits for RS-485 communication.

1. Display the COMMUNICATION menu.
2. Select STOP BIT by moving the joystick up or down.
3. Select 1 or 2 for the number of stop bits by moving the joystick to the right or left.

The initial factory setting is 1 bit.

Note: This setting must be compatible with the peripherals connected.

Wait Time

This item lets you set the waiting time in milliseconds (ms) until the next RS-485 communication retry.

1. Display the COMMUNICATION menu.
2. Select WAIT TIME by moving the joystick up or down.
3. Select OFF, 100, 200, 400 or 1000 ms for the wait time by moving the joystick to the right or left.

The initial factory setting is OFF (No retry).

Delay Time

This item lets you set the minimum delay time from the reception of data to the reply for RS-485 communication.

1. Display the COMMUNICATION menu.
2. Select DELAY TIME by moving the joystick up or down.
3. Select OFF, 20, 40 or 100 ms for the delay time by moving the joystick to the right or left.

The initial factory setting is OFF.

XON/XOFF

This item lets you set the flow control for RS-485 communication.

1. Display the COMMUNICATION menu.
2. Select XON/OFF by moving the joystick up or down.
3. Select the NOT USE or USE mode by moving the joystick to the right or left.

The initial factory setting is NOT USE.

OPERATING PROCEDURES

CAMERA CONTROL FUNCTIONS

Camera control functions are operable.

It is necessary to set up the camera before using the camera control functions. For further information, refer to the Operating Instructions for the respective combination camera (See page 33). You can also set it up from the Camera Setup menu during operating the system.

■ Pan/Tilt Control

A combination camera or an ordinary camera with pan/tilt head can be controlled.

Move the pan/tilt head in the desired direction using the joystick.

Joystick

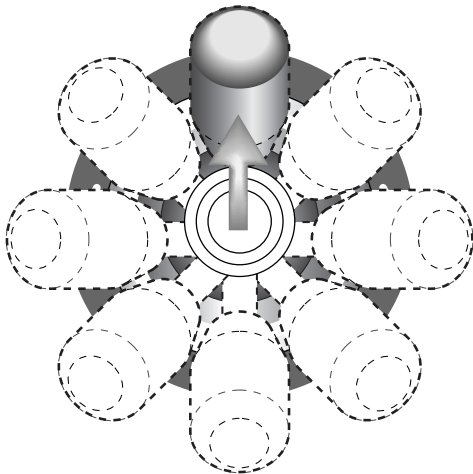

To move the pan/tilt head slowly, move the joystick while holding down the **SLOW/CAMERA FUNCTION** button.

Note: The SLOW/CAMERA FUNCTION button only works in combination with cameras or pan/tilt heads that are provided with more than 8-step speeds.

■ Lens Control

A motorized lens can be controlled.

1. Press the **FOCUS NEAR** or **FOCUS FAR** button to adjust the lens focus while watching the monitor.

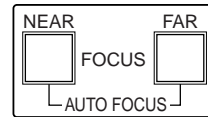

If you are using a camera with an auto focus feature, then the lens focus can be automatically adjusted by simultaneously pressing the **FOCUS NEAR** and **FOCUS FAR** buttons.

2. Press the **ZOOM TELE** button to zoom in on the object or press the **ZOOM WIDE** button to zoom out from the scene.

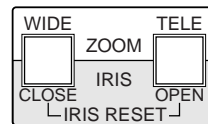

The focal length differs depending on the lens installed on the camera.

3. Press the **SHIFT** button.

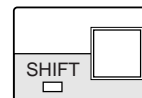

4. Press the **ZOOM/IRIS** buttons to adjust the lens iris while watching the monitor.

If the **IRIS CLOSE** and **IRIS OPEN** buttons are simultaneously pressed for approximately 1 second or more, then the iris is reset to the default values.

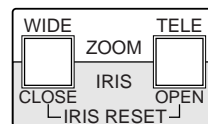

■ Operation of Combination Camera

It is necessary to set up the combination camera before operating it. For further setup information, refer to the Operating Instructions for the combination camera (See page 30). You can also set it up from the Camera Setup menu during operating the system.

● Moving to a Preset Position

The combination camera is moved to a position preset beforehand.

Select a preset number using the numeric buttons, and then press the **PRESET/SET/PROGRAM PRESET** button.

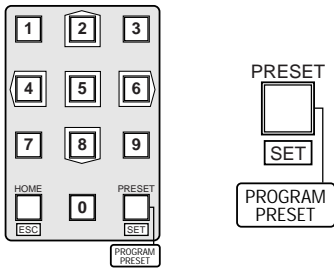

The picture of the camera in that position appears on the monitor.

● Moving to the Home Position

The combination camera is moved to the home position preset beforehand.

Press the **HOME/ESC** button.

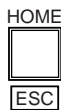

The picture in that position appears on the monitor.

● Auto Pan

The combination camera starts a specific panning mode preset beforehand.

1. Press the **AUTO/B/W/PATROL STOP** button.

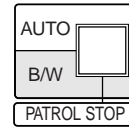

The auto panning function is activated.
The picture appears on the monitor.

The following functions may be also available depending on the combination camera.

AUTO PAN ON or functions set in the combination camera: Press the numeric button 1 and then press this button.

AUTO SORT ON: Press the numeric button 2 and then press this button.

AUTO SEQ ON: Press the numeric button 3 and then press this button.

RANDOM PAN ON: Press the numeric button 4 and then press this button.

For further information, refer to the Operating Instructions for the combination camera.

2. To stop auto pan, move the joystick.

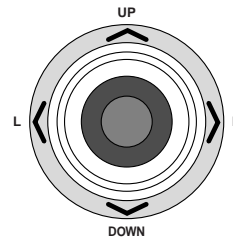

● Patrol Play

The combination camera reproduces a series of pan/tilt movements and lens controls that have been preset beforehand in Patrol Learning.

See page 33 to program the camera patrol learning function.

1. Press the **PATROL PLAY/PATROL LEARN** button.

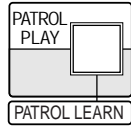

The camera patrol picture appears on the monitor.

2. To stop the patrol play function, move the joystick.

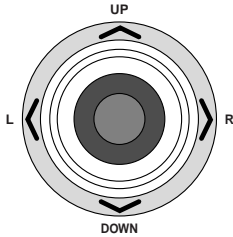

● Color or Black & White

A black and white image is easier to view in dark places while a colored image is better to use in the daylight. Changing from color to B/W and B/W to color can be done manually.

1. Press the **AUTO/B/W/PATROL STOP** button, while the SHIFT indicator is lit, to change from color to a black and white picture. The black and white picture appears on the monitor.



2. Press the **AUTO/B/W/PATROL STOP** button while the SHIFT indicator is lit to change back from black and white to a color picture.



Note: This function is disabled when the B/W is set to AUTO in the camera setup. Set the B/W to ON or OFF to make manual operations possible.

● Combination Camera Shortcuts

The combination camera is controlled using the hundred shortcuts shown in the table. While the SHIFT indicator is lit, type a number using the numeric buttons, and then press the CAMERA FUNCTION button. [CAM FUNC] in the table below is an abbreviation for the CAMERA FUNCTION button. For more details, refer to the Operating Instructions included with the camera.

Function	Key	Function	Key
Selecting a PRESET position	From #1 to #64	EL-ZOOM	
#1	[1] + [CAM FUNC]	On	[9] + [8] + [CAM FUNC]
#10	[1] + [0] + [CAM FUNC]	Off	[9] + [9] + [CAM FUNC]
#64	[6] + [4] + [CAM FUNC]	RESTART	
AUTO PAN		Begin	[1] + [0] + [0] + [CAM FUNC]
ON	[6] + [5] + [CAM FUNC]	Memorize PRESET	From #1 to #64**
OFF	[6] + [6] + [CAM FUNC]	Position #1	[1] + [0] + [1] + [CAM FUNC]
Speed Up	[6] + [7] + [CAM FUNC]	Position #10	[1] + [1] + [0] + [CAM FUNC]
Speed Down	[6] + [8] + [CAM FUNC]	Position #64	[1] + [6] + [4] + [CAM FUNC]
Setting Start Point	[6] + [9] + [CAM FUNC]	PATROL	
Setting End Point	[7] + [0] + [CAM FUNC]	PLAY	[1] + [6] + [5] + [CAM FUNC]
Setting PAN Reverse	[7] + [4] + [CAM FUNC]	STOP	[1] + [6] + [6] + [CAM FUNC]
AUTO MODE		LEARN(Start)	[1] + [6] + [7] + [CAM FUNC]
MODE Off	[7] + [1] + [CAM FUNC]	IRIS	
SEQ On	[7] + [2] + [CAM FUNC]	Open	[1] + [6] + [9] + [CAM FUNC]
SORT On	[7] + [3] + [CAM FUNC]	Close	[1] + [7] + [0] + [CAM FUNC]
ENDLESS PAN		EL-SHUTTER	
On	[7] + [6] + [CAM FUNC]	On	[1] + [7] + [1] + [CAM FUNC]
Off	[7] + [7] + [CAM FUNC]	Off	[1] + [7] + [2] + [CAM FUNC]
DIGITAL FLIP CS854A		Speed Up	[1] + [7] + [3] + [CAM FUNC]
On	[7] + [8] + [CAM FUNC]	Speed Down	[1] + [7] + [4] + [CAM FUNC]
Off	[7] + [9] + [CAM FUNC]	AGC	
PROP. PAN/TILT CS854A		On	[1] + [7] + [5] + [CAM FUNC]
On	[8] + [0] + [CAM FUNC]	Off	[1] + [7] + [6] + [CAM FUNC]
Off	[8] + [1] + [CAM FUNC]	SENS UP CS854A	
SUPER-D2		On	[1] + [7] + [7] + [CAM FUNC]
On	[8] + [4] + [CAM FUNC]	Off	[1] + [7] + [8] + [CAM FUNC]
Off	[8] + [5] + [CAM FUNC]	Up	[1] + [7] + [9] + [CAM FUNC]
AUTO FOCUS		Down	[1] + [8] + [0] + [CAM FUNC]
STOP AF On*	[8] + [6] + [CAM FUNC]	SENS UP AUTO CS854A	
STOP AF Off*	[8] + [7] + [CAM FUNC]	On	[1] + [8] + [1] + [CAM FUNC]
AF On (Activate)	[8] + [8] + [CAM FUNC]	Off	[1] + [8] + [2] + [CAM FUNC]
HOME POSITION		Up	[1] + [8] + [3] + [CAM FUNC]
Move to HOME	[8] + [9] + [CAM FUNC]	Down	[1] + [8] + [4] + [CAM FUNC]
B/W or C/L CS854A		LL SYNC phase	
B/W On*	[9] + [0] + [CAM FUNC]	INC	[1] + [8] + [5] + [CAM FUNC]
B/W Off*	[9] + [1] + [CAM FUNC]	DEC	[1] + [8] + [6] + [CAM FUNC]
B/W AUTO*	[9] + [2] + [CAM FUNC]	PAN	
CAMERA ID		180° turn	[1] + [8] + [7] + [CAM FUNC]
On	[9] + [3] + [CAM FUNC]	CLEANING	
Off	[9] + [4] + [CAM FUNC]	On	[1] + [8] + [8] + [CAM FUNC]
AREA TITLE CS854A		Off	[1] + [8] + [9] + [CAM FUNC]
NESW On	[9] + [5] + [CAM FUNC]	BW SW AUTO CS854A	
USER On	[9] + [6] + [CAM FUNC]	30 sec.	[1] + [9] + [0] + [CAM FUNC]
TITLE Off	[9] + [7] + [CAM FUNC]	60 sec.	[1] + [9] + [1] + [CAM FUNC]
		300 sec.	[1] + [9] + [2] + [CAM FUNC]
		600 sec.	[1] + [9] + [3] + [CAM FUNC]

Notes:

- Shortcut operations marked with * will only change the parameter settings. Actual operations take place when the conditions for changing the settings are met.
- **, "NO REGS. ; FLIP ON" may appear on the monitor. Re-enter the shortcut.
- Shortcuts may be ignored while PAN/TILT, ZOOM or FOCUS is in operation.
- PATROL LEARN only saves [1] through [6]+[4], [1]+[6]+[9] and [1]+[7]+[0] in the memory.
- PATROL PLAY stops when a shortcut other than [1]+[6]+[9] or [1]+[7]+[0] is entered.

■ Camera Housing Control

● Wiper Control

The camera housing provided with the wiper is controlled.

1. Press the **WIPER/AUX1** button to operate the wiper on the selected camera.

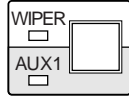

The **WIPER** indicator lights up.

2. Press the **WIPER/AUX1** button to cancel the wiper control function.
The **WIPER** indicator goes off.

Caution: Be sure to turn off the wiper whenever it is not needed or before selecting another camera for viewing in order to prevent the wipers from quickly wearing out.

● Defroster Control

The camera housing provided with the defroster is controlled.

1. Press the **DEF/AUX2** button to operate the defroster for the selected camera.

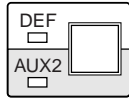

The **DEF** indicator lights up.

2. To cancel the defroster control function, press the **DEF/AUX2** button.
The **DEF** indicator goes off.

■ External Device Control

● Auxiliary Control

An auxiliary device connected to the Receiver or a camera is controlled.

1. Press the **WIPER/AUX1** or **DEF/AUX2** button while the **SHIFT** indicator is lit, to activate the connected device to the receiver.

The **AUX1** or **AUX2** indicator lights up.



2. To cancel the auxiliary control function, press the **WIPER/AUX1** or **DEF/AUX2** button while the **SHIFT** indicator is lit.

The **AUX1** or **AUX2** indicator goes off.

ALARM CONTROL FUNCTIONS

When the WV-CU161C receives an alarm signal from a camera site, an alarm is activated. The WV-CU161C can handle the following alarms.

● Camera Site Alarm

Coaxial Multiplex Communication:

Alarm is multiplexed with video signals from the camera.

RS-485 Site Communication

Alarm is transmitted via RS-485.

● Terminal Alarm

Alarm is input via the alarm input terminal on the rear panel from external devices such as sensors.

■ Alarm Operation

[ALARM] appears on the monitor screen when the alarm signal is supplied in the Alarm On mode

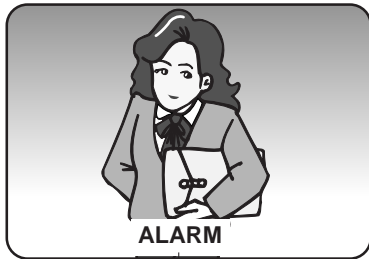

Character display
(ALARM DISPLAY ON)

The alarm indicator starts to blink and the buzzer sounds. (ALARM BUZZER is preset to ON at the factory.)

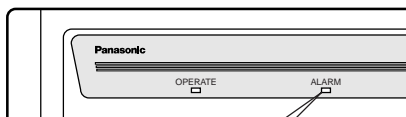

ALARM □	Blinking: Alarm has been activated.
	Light on: Alarm has been reset automatically, or by input signal from external devices (when the alarm switch is in the upper position).
	Light off: Alarm has been reset manually, or the ALARM RESET/SUSPEND button has been pressed while the alarm indicator is on.

If the preset number is set for the ALARM PRESET or ALARM TERMINAL parameter in ALARM SETUP menu, then the camera moves to the preset position when an alarm is activated. The camera picture at that position is displayed on the monitor.

The alarm output signal is supplied to the time lapse VCR until the alarm is reset.

Notes:

- Alarm display On/Off and Buzzer On/Off mode can be selected. (See page 20 and 21.)
- The camera or receiver control can be continued even when an alarm is generated.

■ Alarm Reset

Automatic or manual resetting can be selected.

When the alarm is reset, [ALARM] disappears from the monitor screen and the alarm reset signal is output to the time lapse VCR.

● Automatic Reset

The alarm is automatically reset after the programmed alarm output time has elapsed.

The alarm indicator changes from blinking to steady light, and [ALARM] disappears from the monitor screen.

Press the ALARM RESET/SUSPEND button to turn off the steady light.

Note: Alarm can also be reset by input of the alarm recover signal (no-voltage contact) from the time lapse VCR. The reset mode in this case is the same as for automatic reset.

● Manual Reset

Press the **ALARM RESET/SUSPEND** button.

The alarm indicator goes off, [ALARM] disappears from the monitor screen, and alarm is reset.

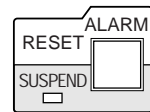

■ Alarm Suspend

The alarm suspension function allows you to suspend the alarm function while setting up the camera or the WV-CU161C.

1. Press the **ALARM RESET/SUSPEND** button while the SHIFT indicator is lit. The **ALARM SUSPEND** indicator lights up.



Alarm input is ignored while the ALARM SUSPEND indicator is lit.

2. To cancel the alarm suspension, press the **ALARM RESET/SUSPEND** button while the SHIFT indicator is lit. The **ALARM SUSPEND** indicator goes off.

CAMERA SETUP

The camera setup operations are available using the WV-CU161C controller on the CAMERA SETUP menus. For further information, refer to the Operating Instructions for the individual combination cameras.

● Camera Setup

1. Hold down the **CAMERA SETUP/SETUP/PROGRAM** button for 2 seconds or more to access the Camera Setup menu. The **CAMERA SETUP** indicator lights up.

(Example of Camera Setup menu)

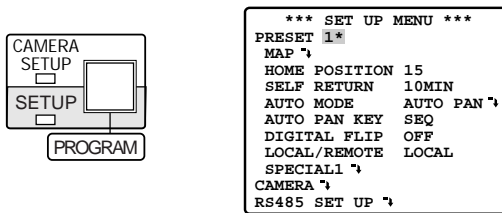

2. Select an item and parameter by pressing numeric buttons **2, 4, 6** and **8**.

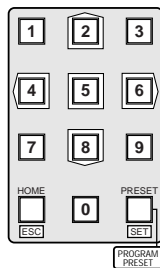

3. Press the **PRESET/SET/PROGRAM PRESET** button to execute the parameter or enter a submenu.

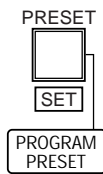

4. Press the **HOME/ESC** button to return to the previous menu.



5. Hold down the **CAMERA SETUP/SETUP/PROGRAM** button for 2 seconds or more to complete the Camera Setup.

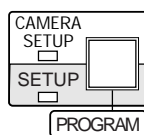

Notes:

- To display the special menu, move the cursor to [SPECIAL] on the setup menu and simultaneously hold down numeric buttons **4** and **6** for 2 seconds or more.
- To restore all default values, move the cursor to [CAMERA RESET]* on the setup menu and simultaneously hold down buttons **4, 5** and **6** for 2 seconds or more.
- The menu for restoring the camera defaults differs depending on the camera type. For example, [SPECIAL] for the WV-CS654, [SPECIAL 2] for the WV-CS854, and [END] for fixed cameras.
- If camera setup is started using the buttons on the camera, then all future setup operations must be performed with the buttons. If camera setup is started using the System Controller, then all future setup operations must be performed using the same controller.
- For further information, refer to the Operating Instructions for the selected camera.

● Keys Used in the Camera Setup Menu

CAMERA SETUP/SETUP/PROGRAM button:

Hold down this button for 2 seconds or more to display the camera SETUP MENU.

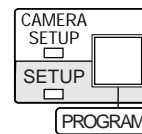

Numeric buttons:

To move the cursor.

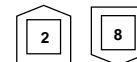

To select modes.

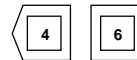

PRESET/SET/PROGRAM PRESET

To enter a submenu.

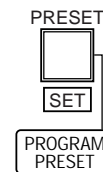

HOME/ESC button:

To return to the previous menu.



● Camera Patrol Learning

There are two ways of setting the camera patrol learning. One is to use the setup menu and the other is to operate the camera.

Follow the procedures described below to set the camera patrol learning up while operating the combination camera.

1. Press the **PATROL LEARN** button while holding down the **PROGRAM** button.

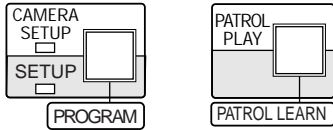

[LEARNING] appears on the monitor.

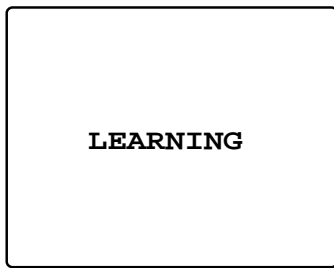

Note: Pressing the PROGRAM button alone for 2 seconds will change the screen to the WV-CU161C SETUP MENU or camera SETUP MENU.

2. Operate the camera using the following controls so that it traces the routine course that is the most frequently patrolled. The learning is programmed for 30 seconds.
 - Pan/Tilt (Joystick)
 - Iris (Open/Close)
 - Focus (Near/Far)
 - Zoom (Tele/Wide)
 - Preset position

Note: The memorized parameters may differ somewhat depending on the camera type. Refer to the manual included with the camera.

3. To stop the learning, press the **PATROL STOP** button while holding down the **PROGRAM** button.

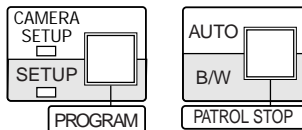

[LEARNING] appears on the monitor.

● Camera Preset Position

There are two ways of presetting camera positions. One is to use the setup menu of the combination camera and the other is to operate the camera.

Follow the procedures described below to set up the camera preset position while operating the combination camera.

1. Move the camera to the position you wish to preset using the joystick.

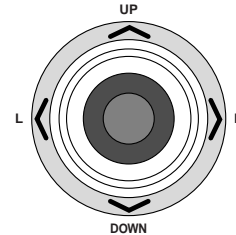

Adjust the picture using the following controls.

- Iris (Open/Close)
- Focus (Near/Far)
- Zoom (Tele/Wide)

Note: The memorized parameters may differ somewhat depending on the camera type. Refer to the manual included with the camera.

2. Type a number with the numeric buttons for the preset position. The typed number appears in the CAMERA section of the LED display.

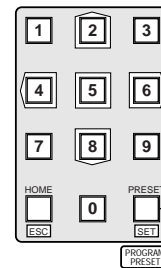

3. Press the **PRESET/SET/PROGRAM PRESET** button while holding down the **CAMERA SETUP/SETUP/PROGRAM** button.

The position and its number are memorized for future recall.

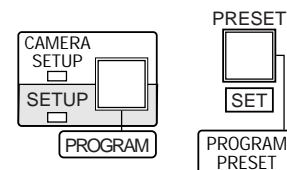

ALL RESET

The WV-CU161C System Controller can be reset to the default settings as follows:

1. Turn off the Power Switch.
2. Turn on the Power Switch while simultaneously pressing numeric buttons **2**, **4** and **6**.

3. Resetting has been completed when all LEDs light up for a few seconds and then go off (except for the Operate Indicator).

Note: The downloaded data for the camera remains as it is.

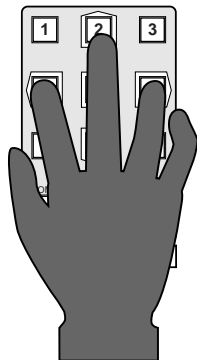

SPECIFICATIONS

Power Source:	120 V AC, 60 Hz
Power Consumption:	6 W
Camera Input:	Composite Video Signal: 1 V[p-p]/75 Ω
Alarm Input:	No-voltage contact
Alarm Recover Input:	No-voltage contact
Video Output:	Composite Video Signal: 1 V[p-p]/75 Ω
Alarm Output:	Open collector: 16 V DC, 100 mA max.
Alarm Reset Output:	Open collector: 16 V DC 100 mA max. Pulse (VCR): +5 V DC approx. 500 m sec. internally switchable
Data Input/Output:	Equivalent to RS-485: 4-Line (Full-Duplex)/2-Line (Half-Duplex) switchable
Lens Control:	Zoom: Tele/Wide Focus: Near/Far/Auto Focus Iris: Open/Close/Preset
Pan/Tilt Control:	Manual Pan/Manual Tilt: 8-directions, 8-steps/4-steps (slow) speed Auto Pan: On/Off Random Pan: On/Off
Housing Control:	Wiper: On/Off Defroster: On/Off AUX 1 - 2
Camera Control:	Position Select: Preset Position, Home Position Camera Patrol: Learn/Play/Stop Electronic Zoom Color/Black and white selectable Camera function Camera Setup Camera Data Upload/Camera Data Download (Up to eight video cameras)
Alarm:	Alarm Buzzer: On/Off Alarm Title Display: On/Off Auto Alarm Reset/Manual Alarm Reset Alarm Suspension/Alarm Suspension Reset
Ambient Operating Temperature:	-10°C - +50°C (14°F - 122°F)
Ambient Operating Humidity:	Less than 90 %
Dimensions:	330 mm (W) x 74.5 mm (H) x 221 (D) mm 13" (W) x 2-15/16" (H) x 8 11/16" (D)
Weight:	2.4 kg (5.3 lbs.)

Dimensions and weight are approximate.
Specifications are subject to change without notice.

Panasonic Security and Digital Imaging Company
A Division of Matsushita Electric Corporation of America

Executive Office: One Panasonic Way 3E-7, Secaucus, New Jersey 07094

Regional Offices:

Northeast: One Panasonic Way, Secaucus, NJ 07094 (201) 348-7303
Southern: 1225 Northbrook Parkway, Suite 1-160, Suwanee, GA 30024 (770) 338-6838
Midwest: 1707 North Randall Road, Elgin, IL 60123 (847) 468-5211
Western: 6550 Katella Ave., Cypress, CA 90630 (714) 373-7840

Panasonic Canada Inc.

5770 Ambler Drive, Mississauga,
Ontario, L4W 2T3 Canada (905)624-5010

Panasonic Sales Company
Division of Matsushita Electric of Puerto Rico Inc.

Ave. 65 de Infanteria. Km. 9.5
San Gabriel Industrial Park, Carolina,
Puerto Rico 00985 (809)750-4300