

Invacare® Comet

SERVICE MANUAL



These instructions contain information about:

testing work

repair work

Edition:11.04.08

A	Mobitec Mobilitätshilfen GmbH Herzog Odilostrasse 101 A-5310 Mondsee Austria	☎ Fax: @: @: WWW:	+43 - 6232 - 55 35 0 +43 - 6232 - 55 35 4 office@mobitec-austria.com austria@invacare.com www.mobitec-austria.com
B	Invacare® n.v. Autobaan 22 B-8210 Loppem (Brugge) Belgium	☎ Fax: @: WWW:	+32 - (0)50 - 83 10 10 +32 - (0)50 - 83 10 11 belgium@invacare.com www.invacare.be
CH	Mobitec Rehab AG Benkenstraße 260 CH-4108 Witterswil Switzerland	☎ Fax: @: @: WWW:	+41 - (0)61 - 48 77 08 0 +41 - (0)61 - 48 77 08 1 office@mobitec-rehab.ch switzerland@invacare.com www.mobitec-rehab.ch
D	Invacare Aquatec Alemannenstraße 10 88316 Isny Deutschland	☎ Fax: @: WWW:	0 75 62 / 7 00 - 251 08 00 / 6 73 81 72 info@invacare-aquatec.de www.invacare-aquatec.de
DK	Invacare® A/S Sdr. Ringvej 39 DK-2605 Brøndby Danmark	☎ (Kundeservice): Fax (Kundeservice): @: WWW:	+45 - (0)36 - 90 00 00 +45 - (0)36 - 90 00 01 denmark@invacare.com www.invacare.dk
E	Invacare® SA c/ Areny, s/n Poligon Industrial de Celrà 17460 Celrà (Girona) ESPAÑA	☎ : Fax: @: WWW:	+34 - (0)972 - 49 32 00 +34 - (0)972 - 49 32 20 contactsp@invacare.com www.invacare.es
F	Invacare® Poirier SAS Route de St Roch F-37230 Fondettes France	☎ : Fax : @: WWW:	+33 - (0)247 - 62 64 66 +33 - (0)247 - 42 12 24 contactfr@invacare.com www.invacare.fr
GB	Invacare® Ltd South Road Bridgend Industrial Estate Mid Glamorgan - CF31-3PY United Kingdom	☎ (Customer Service): Fax (Customer Service): @: @: WWW:	+44 - (0)1656 - 664 321 +44 - (0)1656 - 667 532 uk@invacare.com eire@invacare.com www.invacare.co.uk

I	Invacare Mecc San s.r.l.	☎	+39 - 0445 - 38 00 59
	Via Dei Pini, 62	Fax:	+39 - 0445 - 38 00 34
	I - 36016 Thiene (VI)	@:	italia@invacare.com
	ITALIA	WWW:	www.invacare.it

IE	Invacare Ireland Ltd.	☎	+353 - 18 10 70 84
	Unit 5 Seatown Business Campus	Fax:	+353 - 18 10 70 85
	Seatown Rd, Swords	@:	eire@invacare.com
	County Dublin		
	Ireland		

N	Invacare® AS	☎ (Kundeservice):	+47 - (0)22 57 95 10
	Grensesvingen 9	Fax (Kundeservice):	+47 - (0)22 57 95 01
	Postboks 6230	@:	norway@invacare.com
	N-0603 Oslo	WWW:	www.invacare.no
	Norge		

NL	Invacare® B.V.	☎ :	+31 - (0)318 - 69 57 57
	Celsiusstraat 46	Fax:	+31 - (0)318 - 69 57 58
	NL-6716 BZ Ede	@:	csede@invacare.com
	The Netherlands	WWW:	www.invacare.nl

P	Invacare® PORTUGAL Lda	☎ :	+351-225105946
	Rua Senhora de Campanhã 105	Fax:	+351-225105739
	P-4369-001 Porto	@:	portugal@invacare.com
	PORTUGAL	WWW:	www.invacare.pt

**Aterförsäljare:****Invacare® AB**

Fagerstagatan 9

S-163 91 Spånga

Sverige

☎ (Kundtjänst): +46 - (0) 8 761 70 90

Fax (Kundtjänst): +46 - (0) 8 761 81 08

@: sweden@invacare.com

@: finland@invacare.com

WWW: www.invacare.se

Tillverkare:**Invacare® Deutschland GmbH**

Kleiststraße 49

D-32457 Porta Westfalica

Deutschland**MÖLNDAL**

☎ +46 - (0) 31 – 86 36 00

Fax: +46 - (0) 31 – 86 36 06

@: ginvacare@invacare.com

LANDSKRONA

☎ +46 - (0) 418 – 285 40

Fax: +46 - (0) 418 – 180 89

@: linvacare@invacare.com

OSKARSHAMN

☎ +46 - (0) 491 – 101 40

Fax: +46 - (0) 491 – 101 80

@: oinvacare@invacare.com

Table of Contents

Chapter		Page
1	INTRODUCTION	7
1.1	General information	7
1.2	Notes on transport	7
1.3	Important symbols in this manual	7
2	SAFETY AND ASSEMBLY INSTRUCTIONS	9
2.1	Before any inspection or repair work	9
2.2	General safety information and notes on assembly / disassembly	9
3	TIGHTENING TORQUES	11
4	SERVICE PLAN (1X ANNUALLY)	12
5	OPERATIONAL FAULTS	14
5.1	Operational faults	14
5.1.1	Drive fault diagnosis	14
5.2	Error Codes and Diagnostic Codes	15
6	REPAIR WORK	19
6.1	General warning information on installation work	19
6.2	Replacing the drive motor	19
6.3	Replacing wheel suspension	22
6.4	Replacing shock absorber	24
6.5	Replacing front axle	26
6.6	Replacing steering column/fork 3-wheel	28
6.7	Replacing brakes	32
6.8	Replacing brake cable	34
6.9	Replacing lifter/lifter electronics	35

6.10	Replacing steering linkage/steering rod	37
6.11	Replacing operating console	39
6.12	Replacing bend speed reducer	41
6.13	Replacing the potentiometer	43
6.14	Replacing front headlight (lamp)	46
6.15	Replacing the front direction indicators	48
6.16	Replacing centre brake light	49
6.17	Replacing rear lights/direction indicators	51
6.18	Replacing the electronics module	53
6.19	Updating software	56

1 Introduction

1.1 General information

- All maintenance and overhaul work must be carried out in accordance with these repair instructions.
- Please observe all safety instructions.
- Information about operation or about general maintenance and care work should be taken from the electric vehicle Operating Manual.
- You can find information about ordering spare parts in the spare parts catalogue.
- Use only genuine Invacare® spare parts. Using parts from any other source will void the warranty!
- We reserve the right to make any alterations on the grounds of technical improvements.
- The electric vehicle may only be maintained and overhauled by qualified personnel.
- The minimum requirement for service technicians is relevant training, such as in the cycle or orthopaedic mechanics fields, or suitably long-term job experience.
 - Experience and knowledge of electrical measuring devices (Multimeter) is also a requirement.
 - Special Invacare training sessions are recommended.
- Alterations to the electric vehicle which occur as a result of incorrectly or improperly executed maintenance or overhaul work lead to the exclusion of all liability on the part of INVACARE.
- If you have any problems or questions please contact INVACARE SERVICE.

1.2 Notes on transport

- If the electric vehicle has to be shipped back to the manufacturer for major repairs, you should always use the original packaging for transport.
- You should also include as accurate a fault description as possible.

1.3 Important symbols in this manual



WARNING!

This symbol warns you of danger!

- *Always follow these instructions to avoid injury to the user or damage to the product!*
-



EXPLOSION HAZARD!

This symbol warns you of an explosion hazard, an example of which can be caused by excessive tyre pressure in a pneumatic tyre!

- *Always follow the instructions to avoid injury to the user or damage to the product!*
-



BURN HAZARD!

This symbol warns you of burns due, for example, to leaking battery acid!

- *Always follow the instructions to avoid injury to the user or damage to the product!*
-



NOTE:

This symbol identifies general information which is intended to simplify working with your product and which refers to special functions.



Requirements:

- This symbol identifies a list of various tools, components and items which you will need in order to carry out certain work.
-

2 Safety and assembly instructions

These safety instructions are intended to prevent accidents during work and it is imperative that they are observed.

2.1 Before any inspection or repair work

- Read and observe this repair manual and the associated operating manual!
- Observe the minimum requirements for carrying out the work (see chapter entitled "General information")!

2.2 General safety information and notes on assembly / disassembly



Danger of injury by crushing!

- *Please note the heavy weight of some components. This applies especially to removal of drive units and batteries!*
 - *Prop up the lifted electric vehicle with appropriate supports before starting the disassembly or assembly!*
-



Danger of fire and burns due to electrical short-circuit!

- *The electric vehicle must be switched off before removal of voltage-carrying components! To do this, disconnect the batteries!*
 - *When making measurements on voltage-carrying components, avoid short-circuiting the contacts. Danger of fire and combustion!*
-



Danger of injury and damage to the vehicle can result from incorrect or incomplete maintenance!

- *Only ever use tools which are undamaged in good condition!*
 - *Some moving parts have Teflon bushings! These parts must never be lubricated with grease!*
 - *Never use standard nuts instead of self-locking nuts!*
 - *Always use correctly dimensioned washers or spacers!*
 - *Cable binders which have been cut off during disassembly should be replaced with new ones during reassembly!*
 - *After completing maintenance work and before operating the electric vehicle, make sure all fixations are correctly secured! Check all parts for correct interlocking!*
 - *Only operate the electric vehicle with correct tyre pressure (see Technical Specifications)!*
 - *Check electrical components for correct functioning, incorrect polarity of cables can result in damage to the electronics!*
 - *As a last check, always carry out a test-drive!*
-



Notes

Mark all current settings for the electric vehicle (seat, armrests, backrest etc.), and the cable connecting plugs associated, before any removals. This makes reassembly easier. All plugs are fitted with mechanical safety devices which prevent release of the connecting plugs during operation. To release the connecting plugs the safety devices must be pressed in. When reassembling, ensure that these safety devices are correctly engaged.



WARNING: Any alteration to the drive programme can influence vehicle handling and the tipping stability of the electric vehicle!

- *Alterations to the drive programme may only be carried out by trained Invacare® dealers!*
 - *Invacare® supplies all electric vehicles from the factory with a standard drive programme. Invacare® can only assume a warranty for the safe vehicle handling of the electric vehicle – in particular tipping stability - for this standard drive programme!*
-

3 Tightening torques

The tightening torques stated in the following table are dependent on the thread diameters for the nuts and bolts for which no special values are determined. All values apply to dry and grease-free threads.

Thread	M4	M5	M6	M8	M10	M12	M14	M16
Tightening torque in Nm $\pm 10\%$	3 Nm	6 Nm	10 Nm	25 Nm	49 Nm	80 Nm	120 Nm	180 Nm

Caution: All other nuts or plastic connectors not noted here must be tightened FINGERTIGHT!

4 Service plan (1x annually)

Component	Check	Remedy	Notes	✓
Seat:	<ul style="list-style-type: none"> Welded seams, fixings and upholstery 	<ul style="list-style-type: none"> Tighten screws, replace parts if damaged 		
Frames (chassis) / battery mounting	<ul style="list-style-type: none"> Check fixings, welded seams and battery mounting Check battery fixing straps 	<ul style="list-style-type: none"> Tighten screws, replace parts if damaged 		
Wheel suspension and wheels	<ul style="list-style-type: none"> Check drive wheels for tight fit 	<ul style="list-style-type: none"> Tighten hub nuts, replace if necessary 		
	<ul style="list-style-type: none"> Check steering wheels for tight fit, float and side play 	<ul style="list-style-type: none"> Adjust / replace 		
	<ul style="list-style-type: none"> Pneumatic tyre 	<ul style="list-style-type: none"> Repair or replace if damaged 	See operating manual	
	<ul style="list-style-type: none"> Check tracking and steering linkage. 	<ul style="list-style-type: none"> Tighten screws Check tracking and steering 		
Brake	<ul style="list-style-type: none"> Test brake function in pushing mode 	<ul style="list-style-type: none"> Adjust or replace brake 		
Shock absorber	<ul style="list-style-type: none"> Check shock absorber 	<ul style="list-style-type: none"> Adjust or replace shock absorber 		
Drive units, coupling mechanism	<ul style="list-style-type: none"> Check functions in drive and push modes Check clutch mechanism 	<ul style="list-style-type: none"> Replace motor if necessary Tighten screws / nuts, adjust or replace 		
Lighting	<ul style="list-style-type: none"> Check function Check cable/plug connections 	<ul style="list-style-type: none"> Replace lightbulbs or cable 		
Batteries	<ul style="list-style-type: none"> Check batteries for damage 	<ul style="list-style-type: none"> Replace batteries 	See operating manual	
	<ul style="list-style-type: none"> Check battery voltage 	<ul style="list-style-type: none"> charge batteries 	See operating manual	
	<ul style="list-style-type: none"> Check contacts and terminals 	<ul style="list-style-type: none"> Clean contacts and terminals 		
Drive electronics	<ul style="list-style-type: none"> Status display flashing Fixing Cable, connecting plug Drive lever function Power supply 	<ul style="list-style-type: none"> Evaluate blinking code Tighten or replace fixing. Replace cable, connecting plug. Replace drive lever Replace cable, connecting plug or console 		

Component	Check	Remedy	Notes	✓
Drive program	<ul style="list-style-type: none"> • Check drive electronics program version Newer version available? 	<ul style="list-style-type: none"> • Update software 		
Speed reduction in bends	<ul style="list-style-type: none"> • Check cable and connecting plug • Check function 	<ul style="list-style-type: none"> • Adjust or replace sensor on relay. 		

5 Operational Faults

5.1 Operational faults

Please proceed as follows if you have any problems:

- First assess the possible cause of the problem using the following table.
- Check the drive console status display. Evaluate the blink error code.
- Carry out the necessary checks and repairs as recommended in the following table.

5.1.1 Drive fault diagnosis

PROBLEM	OTHER SYMPTOMS	POSSIBLE CAUSE	SOLUTION	Documentation
Scooter will not start	Status display on operating console does not illuminate	batteries defective	<ul style="list-style-type: none"> • Replace batteries 	See operating manual
		completely discharge battery	<ul style="list-style-type: none"> • Pre-charge batteries 	
		Power supply to operating console possibly interrupted	<ul style="list-style-type: none"> • Check master fuse 	See operating instructions for main fuse position
			<ul style="list-style-type: none"> • Check cable between modules for loose connections or damage 	See " Replacing the electronics module " on page 53
	Operating console defective	<ul style="list-style-type: none"> • Replace operating console 	See " Replacing operating console " on page 39	
Operating unit status display blinking	Various causes	<ul style="list-style-type: none"> • Assess error code 	See " Error Codes and Diagnostic Codes " on page 15	

PROBLEM	OTHER SYMPTOMS	POSSIBLE CAUSE	SOLUTION	Documentation
Scooter judders in drive mode	None	Drive motor defective	<ul style="list-style-type: none"> Replace motor(s) 	See " Replacing the drive motor " on page 19
		Drive lever potentiometer defective	<ul style="list-style-type: none"> Replacing the potentiometer 	See " Replacing the potentiometer " on page 43
Batteries not being charged	None	batteries defective	<ul style="list-style-type: none"> Replace batteries 	See operating manual
	LEDs blinking on charging unit	Charging unit defective	<ul style="list-style-type: none"> Replace charging unit 	See charging unit operating manual
Scooter runs too slowly	None	Operating console defective	<ul style="list-style-type: none"> Replace operating console 	See " Replacing operating console " on page 39
		batteries defective	<ul style="list-style-type: none"> Replace batteries 	See operating manual
Scooter does not reduce speed on bends.	None	Speed reducer for bend travel not adjusted.	<ul style="list-style-type: none"> Adjust speed reducer 	
		Speed reducer defective	<ul style="list-style-type: none"> Replace speed reducer 	See chapter "Replacing speed reducer".

5.2 Error Codes and Diagnostic Codes

Blink code	Fault	Consequence for the Scooter	Comments
1	Battery must be charged	Continues to drive	<ul style="list-style-type: none"> The batteries are discharged. Charge the battery as soon as possible.
2	Battery voltage too low	Stops driving	<ul style="list-style-type: none"> The batteries are depleted. Charge batteries. If you switch the Scooter off for a few minutes, the battery can often recuperate to such a stage that a short journey is still possible.
3	Battery voltage too high	Stops driving	<ul style="list-style-type: none"> The battery voltage is too high. If the battery charger is connected, disconnect it from the Scooter. The electronic system charges the batteries when running downhill and when braking. This fault is caused when the battery voltage becomes too high during this process. Switch the Scooter off and on again.

Blink code	Fault	Consequence for the Scooter	Comments
4	Power time exceeded	Stops driving	<ul style="list-style-type: none"> The maximum current was exceeded over too long a period, probably because the motor was overloaded or has been working against an immovable resistance. Switch the scooter off, wait a few minutes and then switch on again. The electronic system has determined a motor short-circuit. Check the wiring harness for short-circuit and check the motor. Contact your Invacare® dealer.
5	Brake failure	Stops driving	<ul style="list-style-type: none"> Ensure that the disconnection lever is pressed in. There is a defect in the braking coil or in the cabling. Check the magnetic brake and cabling for open or short-circuited circuitry. Contact your Invacare® dealer.
6	No neutral position when switching Scooter on.	Stops driving	<ul style="list-style-type: none"> Drive lever is not in neutral when the keyswitch was turned. Put the drive lever in neutral, turn the power off and then turn on again. It may be necessary to recalibrate the drive lever. Contact your Invacare® dealer.
7	Fault in speed potentiometer	Stops driving	<ul style="list-style-type: none"> The drive lever electronics could be faulty or incorrectly connected. Check the cabling for open or short-circuited circuitry. Potentiometer is not correctly adjusted. Put the potentiometer into the centre position.
8	Motor voltage error	Stops driving	<ul style="list-style-type: none"> The motor or its cabling is defective. Check the cabling for open or short-circuited circuitry.
9	Miscellaneous internal fault	Stops driving	<ul style="list-style-type: none"> Contact your Invacare® dealer.
10	Push/freewheel mode error	Stops driving	<ul style="list-style-type: none"> The Scooter has exceeded the permissible maximum speed during pushing or freewheeling. Switch the electronics system off and on again.

Blink code	Fault	Consequence for the Scooter	Comments
1	Battery must be charged	Continues to drive	<ul style="list-style-type: none"> The batteries are discharged. Charge the battery as soon as possible.

Blink code	Fault	Consequence for the Scooter	Comments
2	Battery voltage too low	Stops driving	<ul style="list-style-type: none"> The batteries are depleted. Charge batteries. If you switch the Scooter off for a few minutes, the battery can often recuperate to such a stage that a short journey is still possible.
	Speed reduction for driving round bends activated.	Reduced driving speed	
3	Battery voltage too high	Stops driving	<ul style="list-style-type: none"> The battery voltage is too high. If the battery charger is connected, disconnect it from the Scooter. The electronic system charges the batteries when running downhill and when braking. This fault is caused when the battery voltage becomes too high during this process. Switch the Scooter off and on again.
4	Power time exceeded	Stops driving	<ul style="list-style-type: none"> The maximum current was exceeded over too long a period, probably because the motor was overloaded or has been working against an immovable resistance. Switch the scooter off, wait a few minutes and then switch on again. The electronic system has determined a motor short-circuit. Check the wiring harness for short-circuit and check the motor. Contact your Invacare® dealer.
5	Brake failure	Stops driving	<ul style="list-style-type: none"> Ensure that the disconnection lever is pressed in. There is a defect in the braking coil or in the cabling. Check the magnetic brake and cabling for open or short-circuited circuitry. Contact your Invacare® dealer.
6	No neutral position when switching Scooter on.	Stops driving	<ul style="list-style-type: none"> Drive lever is not in neutral when the keyswitch was turned. Put the drive lever in neutral, turn the power off and then turn on again. It may be necessary to recalibrate the drive lever. Contact your Invacare® dealer.
7	Fault in speed potentiometer	Stops driving	<ul style="list-style-type: none"> The drive lever electronics could be faulty or incorrectly connected. Check the cabling for open or short-circuited circuitry. Potentiometer is not correctly adjusted. Put the potentiometer into the centre position.

Blink code	Fault	Consequence for the Scooter	Comments
8	Motor voltage error	Stops driving	<ul style="list-style-type: none"> The motor or its cabling is defective Check the cabling for open or short-circuited circuitry.
9	Miscellaneous internal fault	Stops driving	<ul style="list-style-type: none"> Contact your Invacare® dealer.
10	Push/freewheel mode error	Stops driving	<ul style="list-style-type: none"> The Scooter has exceeded the permissible maximum speed during pushing or freewheeling. Switch the electronics system off and on again.

6 Repair Work

6.1 General warning information on installation work



CAUTION: Risk of damage to the vehicle! Collisions can be caused if shim rings are removed from the drive wheels during installation work!

- *Shim rings are frequently placed between the drive shaft and the wheel hub to compensate tolerances. Collisions can be caused if these shim rings are removed and not re-installed! Please install all shim rings in exactly the same positions they were in before dismantling.*

6.2 Replacing the drive motor



CAUTION! If the scooter is supported by the support wheels, it will no longer be braked by the motor brake. The scooter can roll away out of control.

- *Place the scooter rear frame on a piece of supporting wood before removing the wheels.*



CAUTION! Accident hazard.

- *Secure the scooter against rolling away.*



NOTE:

When disassembling, note the position of small parts such as screws and washers. Put small parts down so that they can be reassembled in the right sequence.



NOTE:

The plugs on the electronic module cannot be wrongly connected because all plugs have a different size and only fit in one socket.



Requirements:

- Open spanner, 10 mm.
- Open spanner, 17 mm.
- oblique pliers
- Rubber hammer
- Phillips screwdriver
- Supporting wooden block

- Secure the scooter against rolling away.
- Place supporting wooden block under the frames at battery holder height.
- Remove the seat.
- Remove motor cover.
- Disconnect both battery plugs (1).



- **From the operating manual:**

- Unscrew the rear wheel fixing bolts.
- Remove rear wheels.

- Disconnect plugs (1, 2, 3) from electronic module.
- Disconnect brake light plug (4).
- Disconnect motor brake plug (5).

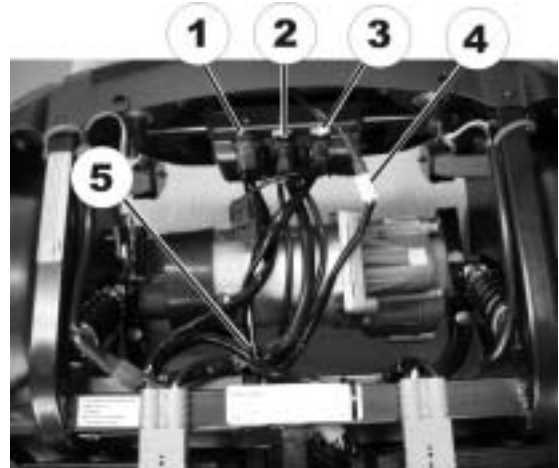

- Remove the bolt (2) on the wheel cover.
- Remove wheel cover (1).

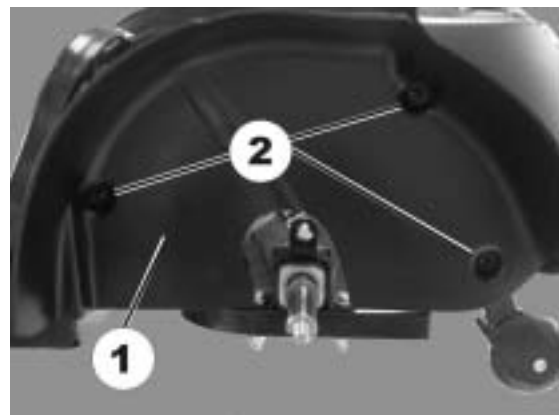

- Place a supporting block of wood under the motor link fork.
- Remove screws (1) on shock absorber (2).
- Remove screws (3) from the drive holder (4).
- Remove drive holder (4).

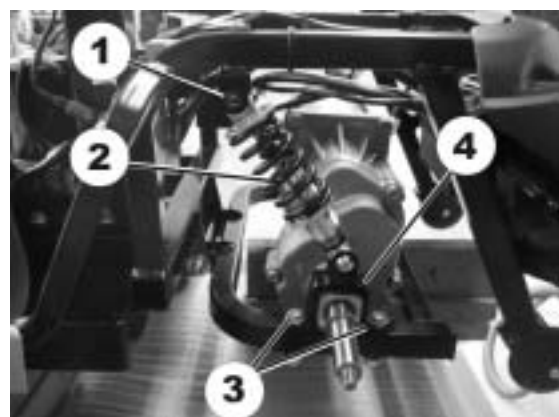

- Remove screws (1) on disengaging lever (2).
- Remove disengaging lever (2).

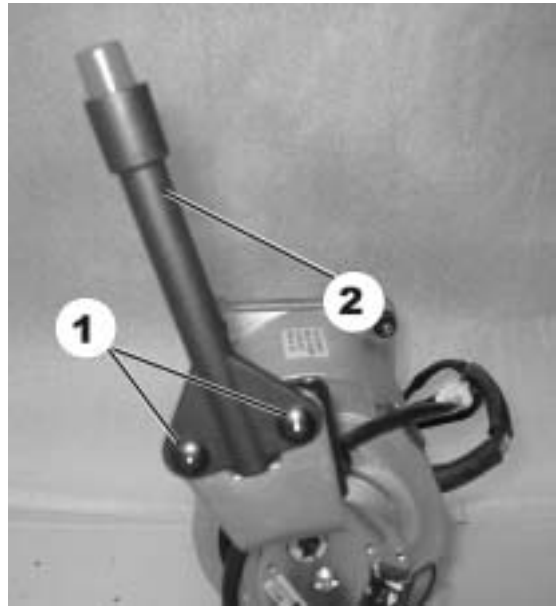

- Lifted drive out of its holder and take it out of the frames to the side.
- Replace drive unit.
- Reassembly of the drive takes place in reverse order
- Check all functions (trial run).

6.3 Replacing wheel suspension



CAUTION! Accident hazard.

- *Secure the scooter against rolling away.*
-

**NOTE:**

When disassembling, note the position of small parts such as screws and washers. Put small parts down so that they can be reassembled in the right sequence.

**Requirements:**

- Open spanner, 32 mm.
 - Phillips screwdriver
 - Supporting wooden block
-

- Remove the seat.
- Remove motor cover.
- Disconnect battery cable (1).

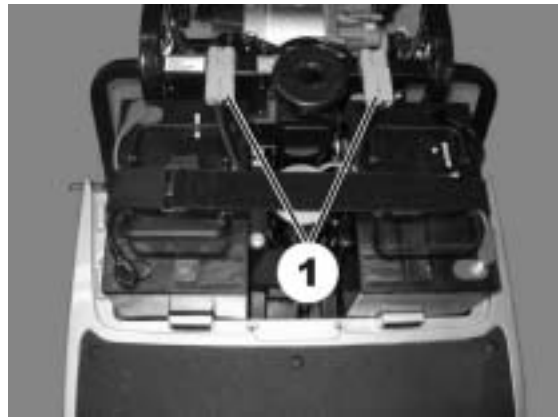

- Dismantle chassis and steering column (see chapter "Replacing steering column/forks).
- Dismantle steering linkage and steering rod (see chapter "Replacing steering link/steering rod").
- Loosen wheel suspension screw (1).
- Loosen knurled screw (2).
- Replace wheel suspension



- Reassembly takes place in the reverse order.
- Apply brake and hold, tighten wheel bolts at same time.
- Adjust tracking (see chapter "Replacing steering linkage/steering rod").
- Check function (trial run).

6.4 Replacing shock absorber



CAUTION! If the scooter is supported by the support wheels, it will no longer be braked by the motor brake. The scooter can roll away out of control.

- Place the scooter rear frame on a piece of supporting wood once you have removed the wheels.



CAUTION! Accident hazard.

- Secure the scooter against rolling away.



NOTE:

When disassembling, note the position of small parts such as screws and washers. Put small parts down so that they can be reassembled in the right sequence.



NOTE:

The drive motor needs to be removed before you can replace the left-hand shock absorber. If the right-hand shock absorber is to be replaced, you do not need to remove the drive motor.



Requirements:

- Open spanner, 10 mm.
- Open spanner, 17 mm.
- Phillips screwdriver
- 2 Allen keys 5m
- Supporting wooden block

- Remove wheel (see operating manual)
- Dismantle wheel cover (see chapter "Replacing drive motor")

• **Replacing rear shock absorber:**

- Remove top screw (1) on shock absorber (2).
- Remove both screws (4) from motor bracket (5).
- Remove shock absorber (2) with motor bracket (5).
- Remove bottom screw (6) on shock absorber (2).
- Replace shock absorber (2).

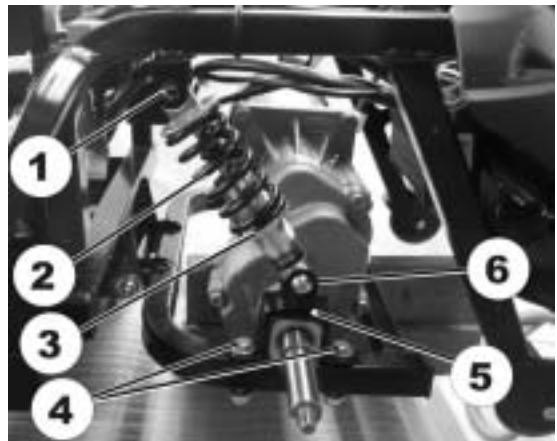

- **Replacing front shock absorber:**
- Remove top screw (1) on shock absorber (2).
- Remove bottom screw (4) on shock absorber (2).
- Replace shock absorber (2).

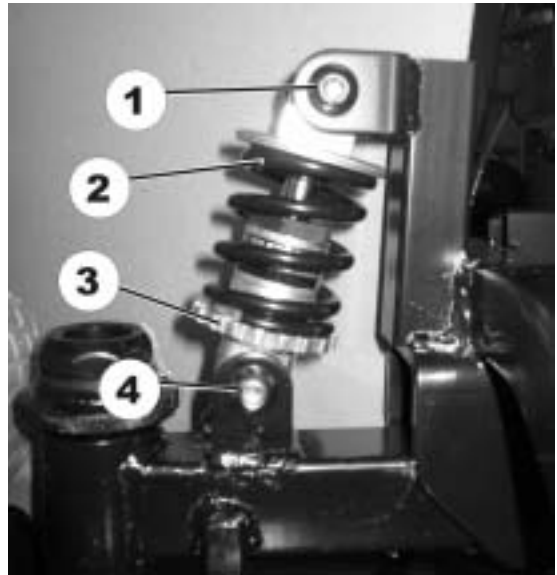

- Reassembly of the shock absorber takes place in reverse order.
- Use setting screw (3) to set the spring hardness.
- Check function (trial run).

6.5 Replacing front axle



CAUTION! Accident hazard.

- *Secure the scooter against rolling away.*



NOTE:

When disassembling, note the position of small parts such as screws and washers. Put small parts down so that they can be reassembled in the right sequence.



NOTE:

The front axle can only be replaced on the 3-wheel version. The 4-wheel version does not have a replaceable axle.



Requirements:

- Open spanner, 17 mm.
 - Open spanner, 19 mm.
 - Supporting wooden block
-
- Place a supporting wooden block under the front part of the frame so that the front wheel is no longer touching the floor.
 - Loosen axle bolts (1) simultaneously on both sides.
-
- Slacken brake cable (see chapter entitled "Replacing brake cables").
 - Disconnect the brake cable at the wheel (1).
 - Remove screws (3) on spacer (2).
 - Remove screws (6) on shock absorber (5).
 - Loosen axle bolts (4) simultaneously on both sides.
 - Pull front axle slowly out.

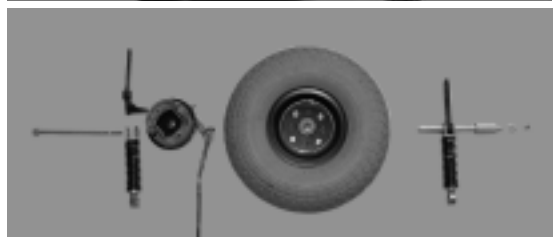
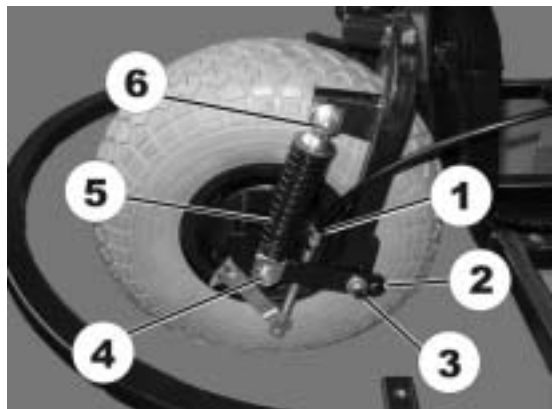
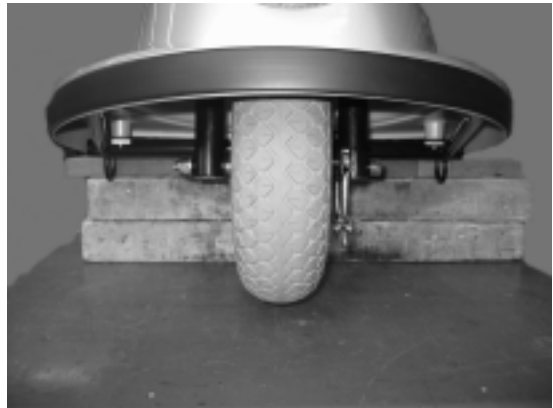

- Reassembly of the axle takes place in reverse order
- Operate brake and hold, tighten axle bolts at same time.
- Check function (trial run).

6.6 Replacing steering column/fork 3-wheel



CAUTION! Accident hazard.

- *Secure the scooter against rolling away.*
-

**NOTE:**

When disassembling, note the position of small parts such as screws and washers. Put small parts down so that they can be reassembled in the right sequence.

**Requirements:**

- Open spanner, 10 mm.
 - Open spanner, 17 mm.
 - Open spanner, 19 mm.
 - Open spanner, 32 mm.
 - Phillips screwdriver
 - Supporting wooden block
-

- Remove the seat.
- Remove motor cover.
- Separate battery cable.



- Place a supporting wooden block under the front part of the frame so that the front wheel is no longer touching the floor.

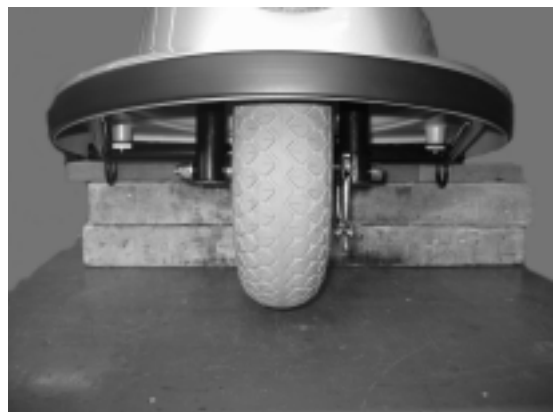

- **Replacing steering column:**
- Remove drive lever screws (3).
- Remove drive lever (2).
- Unscrew the bolts (1) on the drive console.
- Remove drive console.

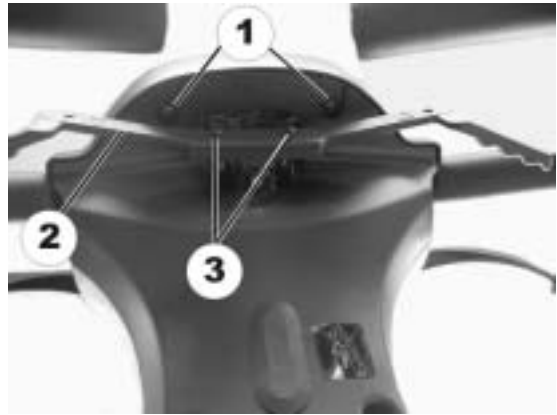

- Remove screws (1) on rear steering column cladding.
- Remove steering column cladding.



- Loosen screws on front basket holder.
- Remove basket holder.
- Remove spacer bushes.

- Disconnect cable (1, 2) from wiring harness.
- Remove screws (3) on front steering column cladding.
- Remove the front steering column cladding.

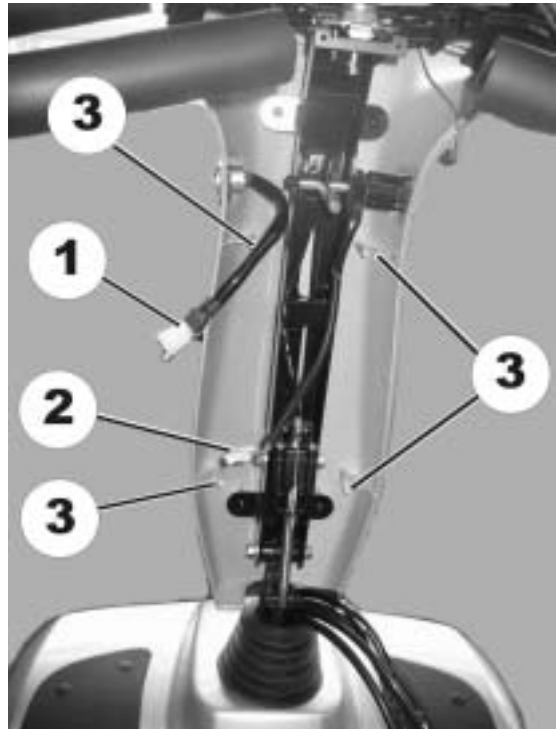

- Loosen the brake cable. (see Chapter "Replacing brakes")
- Unscrew screw at clamp (1).
- Unscrew fixing bolt for steering column and remove.
- Pull steering column out upwards.

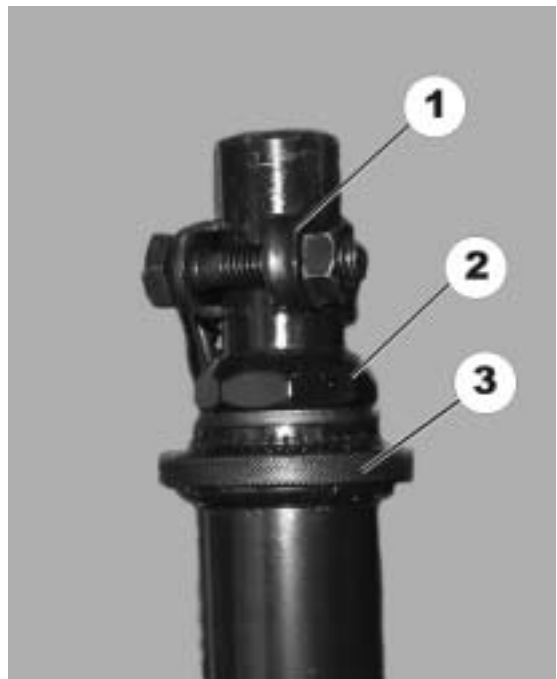

- **Replacing fork 3-wheel:**
- Remove rubber mat in foot well.
- Loosen screws in chassis below mat.
- Remove chassis upwards.

- Dismantle front wheel (see chapter "Replace front axle").

- Pull off clamp (1).
- Loosen fork bolt (2).
- Loosen knurled screw (3).
- Replace fork.

- Reassembly takes place in the reverse order.
- Operate brake and hold, tighten axle bolts at same time.
- Check functions (trial run).

6.7 Replacing brakes



CAUTION! Accident hazard.

- Secure the scooter against rolling away.



NOTE:

When disassembling, note the position of small parts such as screws and washers. Put small parts down so that they can be reassembled in the right sequence.



NOTE:

The front axle can only be replaced on the 3-wheel version. The 4-wheel version does not have a replaceable axle.



Requirements:

- Open spanner, 12 mm.
 - Open spanner, 13 mm.
 - Philips screwdriver
 - Allen key 5 mm
 - Supporting wooden block
-
- Remove the seat.
 - Remove motor cover.
 - Separate battery cable.
-
- Place a supporting wooden block under the front part of the frame so that the front wheel is no longer touching the floor.

- **3-wheel version:**

- Slacken brake cable (see chapter entitled "Replacing brake cables").
- Disconnect the brake cable at the wheel (1).
- Remove screws (3) on spacer (2).
- Remove screws (6) on shock absorber (5).
- Loosen axle bolts (4) simultaneously on both sides.
- Pull front axle slowly out.

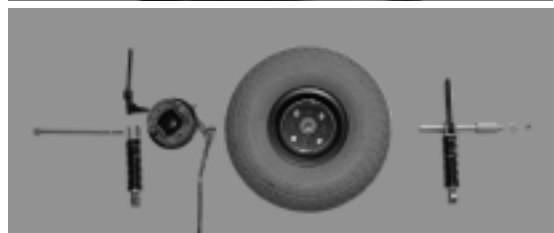
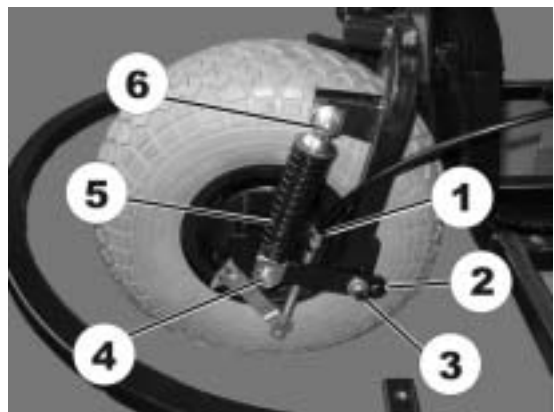

- **4-wheel version:**
- Slacken both brake cables.
- Disconnect brake cable at affected wheel.
- Loosen wheel bolt.
- Pull wheel and brake off shaft.

- Pull brake out of brake drum.
- Replace brake lining or complete brake.



- Reassemble wheel and brake.
- Push wheel and brake onto shaft, or push axle through.
- Apply brake so that brake shoes can align.

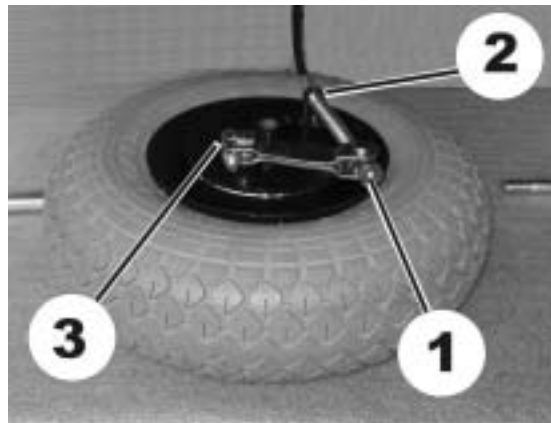

- Reassembly of the brake takes place in reverse order
- Adjust braking force on wheel using brake lever setting screw.
- Check braking function while pushing.

6.8 Replacing brake cable



CAUTION! Accident hazard.

- *Secure the scooter against rolling away.*
-

**NOTE:**

When disassembling, note the position of small parts such as screws and washers. Put small parts down so that they can be reassembled in the right sequence.

**Requirements:**

- Open spanner, 10 mm.
 - Phillips screwdriver
-

- Decrease the brake tension on the wheel using the setting screw (1).
- Disconnect the brake cable at the wheel (2).
- Disconnect brake cable at steering wheel brake lever.
- Route the brake cable through the cladding.
- Loosen brake lever screw (3) at wheel.
- Replace brake cable.

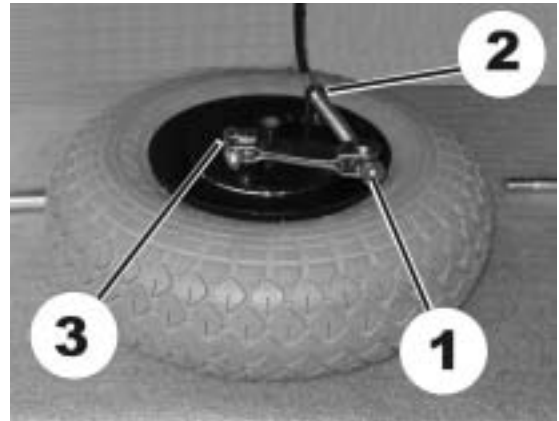

- Reassembly of the brake cable takes place in reverse order.
- Check braking function while pushing.

6.9 Replacing lifter/lifter electronics



CAUTION! Accident hazard.

- Secure the scooter against rolling away.



NOTE:

When disassembling, note the position of small parts such as screws and washers. Put small parts down so that they can be reassembled in the right sequence.



Requirements:

- Open spanner, 14 mm.
- Phillips screwdriver

- Secure the scooter against rolling away.
- Remove the seat.
- Remove motor cover.
- Disconnect both battery plugs (1).

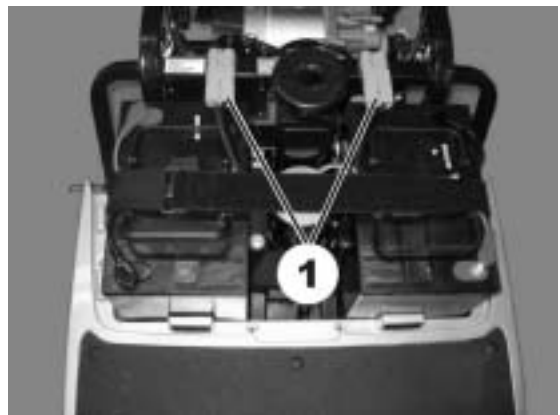

- **Replacing lifter:**
- Remove batteries.
- Disconnect lifter cable at wiring harness connecting plug in motor enclosure.
- Remove screws (1) on lifter (2).
- Replace lifter.

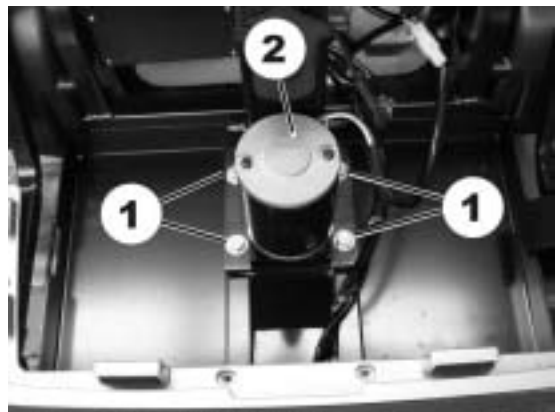

- **Replacing lifter electronics:**
- Remove both screws (1) from the lifter electronics (2).
- Replace lifter electronics (2).

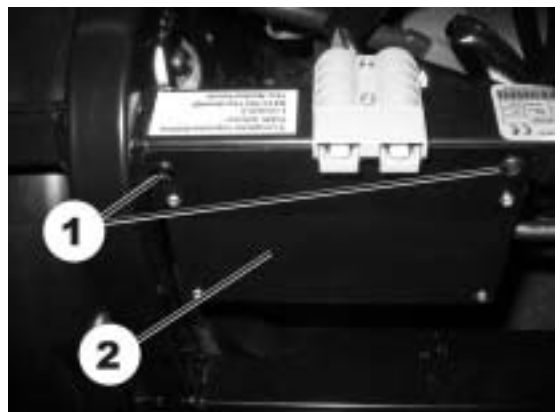

- **Replacing fuses in lifter electronics:**
- Unscrew lifter electronics cover.
- Replace fuse (1).

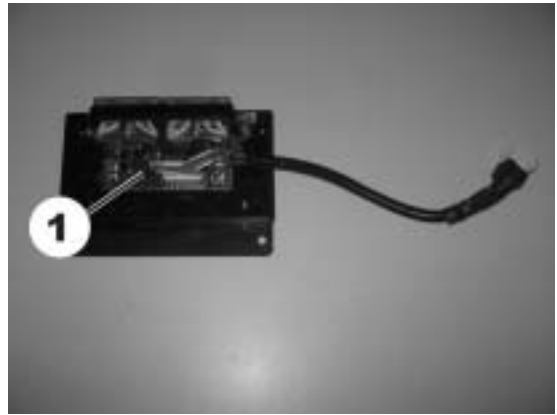

- Reassembly takes place in the reverse order.
- Check function

6.10 Replacing steering linkage/steering rod



CAUTION! Accident hazard.

- *Secure the scooter against rolling away.*
-



NOTE:

When disassembling, note the position of small parts such as screws and washers. Put small parts down so that they can be reassembled in the right sequence.



Requirements:

- Open spanner, 10 mm.
 - Open spanner, 12 mm.
 - Open spanner, 13 mm.
 - Phillips screwdriver
 - Circlip pliers
 - Supporting wooden block
-

- Remove the seat.
- Remove motor cover.
- Disconnect battery cable (1).

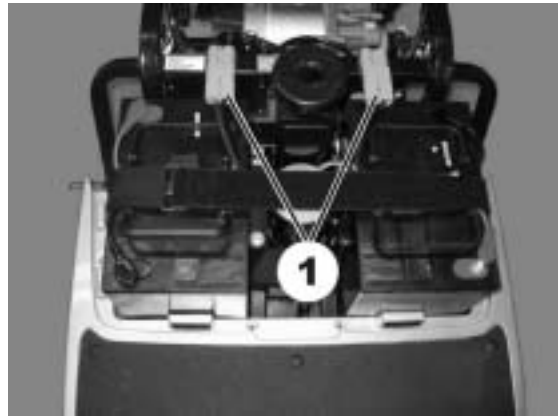

- Dismantle the steering column and the chassis (see chapter "Replacing steering column/forks).

- **Replacing steering link:**
- Remove circlip (1) on steering link (2).
- Replace steering link.
- Adjust length of steering link using setting screws (3).
- **Replacing steering rod:**
- Remove circlip (4) on steering rod (5).
- Replace steering rod.
- Adjust tracking by 1° inwards using setting screw (6). (See sketch).

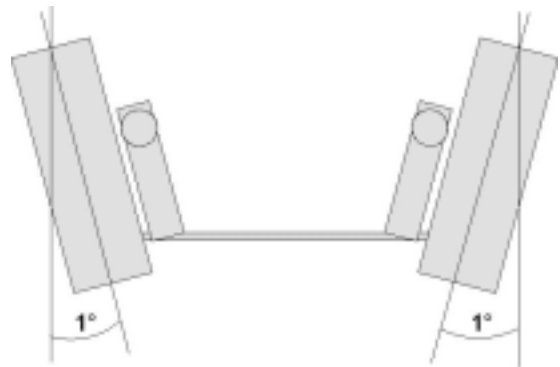
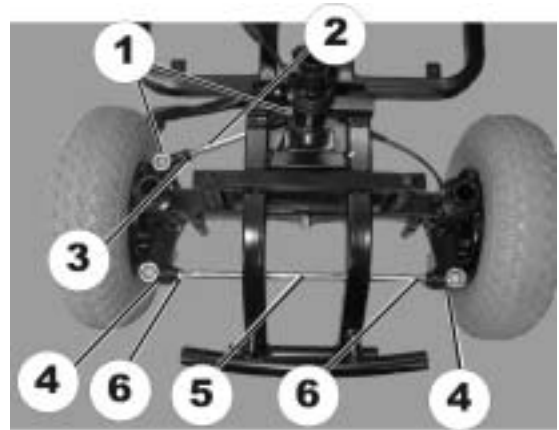

- Reassembly of the steering linkage and/or steering rod takes place in reverse order.
- Check function (trial run).

6.11 Replacing operating console



CAUTION! Burn and scald hazard if power cable is short-circuited!

- *Interrupt the power supply by removing the battery plugs before you start work on the electronic system.*
-

**NOTE:**

The plugs on the operating console cannot be wrongly connected because all plugs have a different size and only fit in one socket.

**Requirements:**

- Phillips screwdriver
-

- Remove the seat.
- Remove motor cover.
- Disconnect battery cable (1).



- Remove screws (1) below operating console.
- Remove operating console and fold upwards.
- Remove screws (3) on drive lever (2) and remove drive lever.

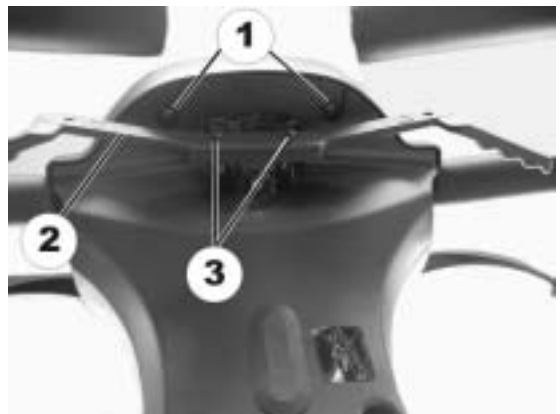

- Disconnect plug from operating console circuit board.
- Replace operating console.
- Reconnect plug with circuit board on new operating console.

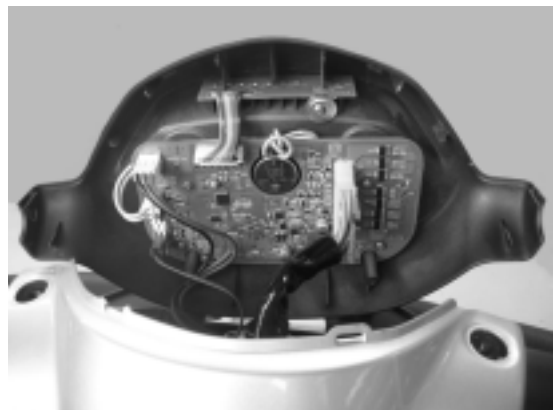

- Reassembly of the operating console takes place in reverse order
- Check all functions (trial run).

6.12 Replacing bend speed reducer



CAUTION! Accident hazard.

- *Secure the scooter against rolling away.*
-

**NOTE:**

When disassembling, note the position of small parts such as screws and washers. Put small parts down so that they can be reassembled in the right sequence.

**Requirements:**

- Phillips screwdriver
 - Open spanner, 32 mm.
-

- Remove the seat.
- Remove motor cover.
- Separate battery cable.

- Remove front and rear steering column cladding, steering column and housing. (See chapter entitled "Replacing steering column").

- **Replacing sensors (5) without mounting:**
 - Loosen screws.
 - Replace sensor.
- **Replacing sensors (5) with mounting:**
 - Loosen fork bolt (1).
 - Replace sensors (5) with mounting:
- **Replacing regulating unit (4):**
 - Loosen screws.
 - Remove sensor (5).
 - Loosen screws (3).
 - Replace regulating unit (4).

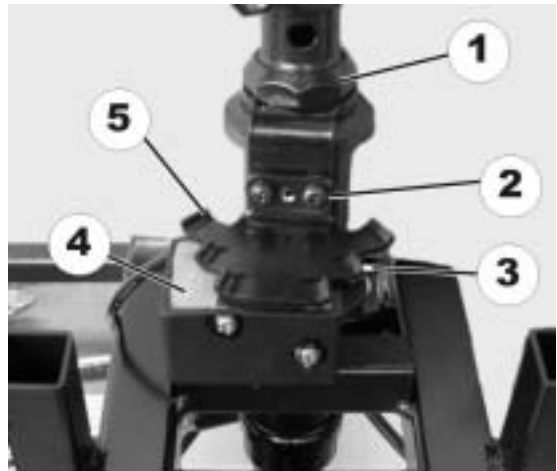

- **Adjusting:**
- Set steering to straight ahead.
- Align sensor straight using regulating unit.
- Take hold of the sensor and tighten the fork screw.
- **Check:**
- Turn the steering completely to the right and then the left.
- When the steering is turned to its limit, the 3 regulating unit switches should be visible.

- Reassembly takes place in the reverse order.
- Check functions (trial run).

6.13 Replacing the potentiometer



CAUTION! Burn and scald hazard if power cable is short-circuited!

- *Interrupt the power supply by removing the battery plugs before you start work on the electronic system.*
-

**CAUTION! Risk of accidents!**

- *The new potentiometer must be set to the middle position before inserting. Potentiometers which are not in the middle position can result in dangerous driving situations!*
-

**Requirements:**

- Phillips screwdriver
 - Digital multimeter
 - Allen key 2m
-

- Remove the seat.
- Remove motor cover.
- Disconnect battery cable (1).



- Remove screws (1) below operating console.
- Remove operating console and fold upwards.
- Remove screws (3) on drive lever (2) and remove drive lever.

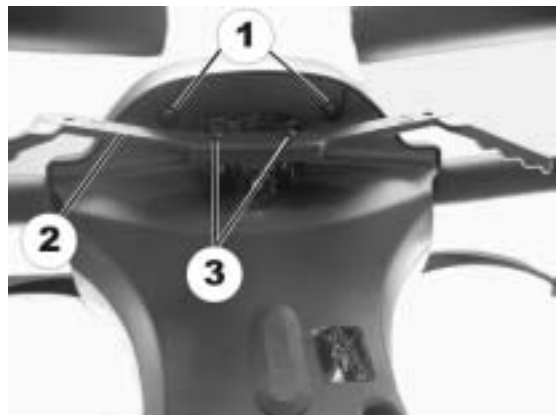

- Disconnect potentiometer plug (1) from the operating console.



- Remove screws (1) on potentiometer.
- Replace potentiometer

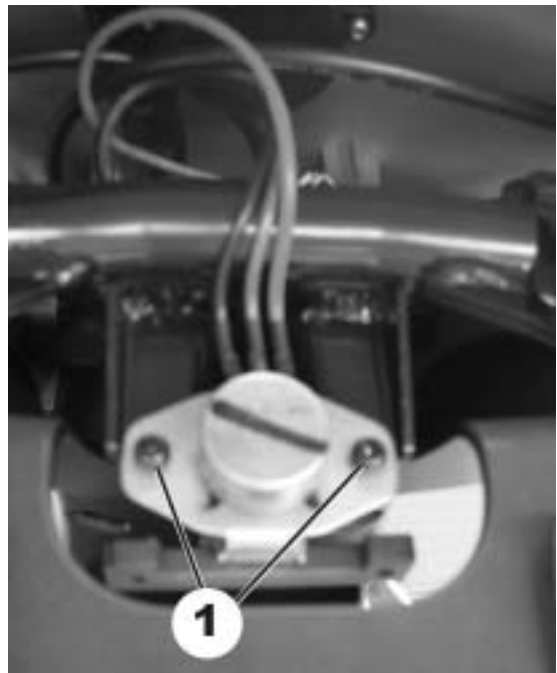

- Reconnect potentiometer plug (1) with operating console.



- **Setting the potentiometer to the middle position:**
- Loosen the bolts (1) on the drive lever mounting.
- Twist the potentiometer shaft (2) until the same resistance (approx. 5kOhm) is measured between the central connection cable (3) and both outputs (4).
- Retighten the bolts on the drive lever mounting.
- Check settings and repeat the adjustment if necessary.

- Reassembly of the operating console takes place in reverse order
- Check all functions (trial run).

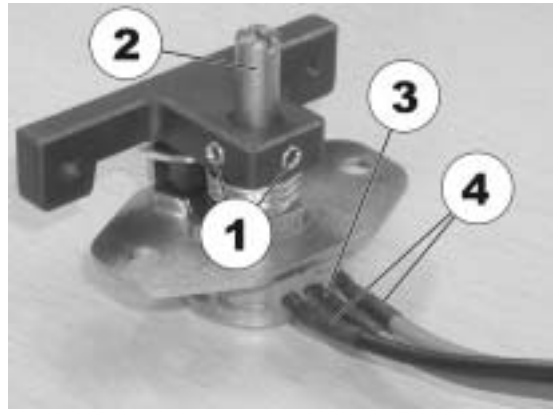

6.14 Replacing front headlight (lamp)



NOTE:

You can replace the headlight without removing the chassis. If, however, the working space is too small, you can remove the chassis as described in chapter "Replacing steering column/forks".



Requirements:

- Phillips screwdriver

- Remove the seat.
- Remove motor cover.
- Disconnect battery cable (1).



- Remove rear steering column cladding (see chapter "Replacing steering column/forks").

- **3-wheel version**

- Remove screw (1) on front headlight under front cladding.
- Disconnect direction indicator cable (2) at wiring harness behind steering column cladding.



- **4-wheel version**
- Remove screws (1) on front headlight under front cladding.
- Disconnect direction indicator cable (2) at wiring harness behind steering column cladding.

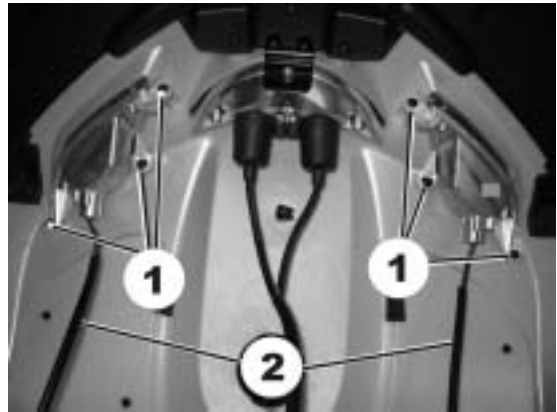

- Remove headlight.
- Remove screws (1) on headlight glass.
- Remove headlight glass.
- Replace bulb (2) in headlight.

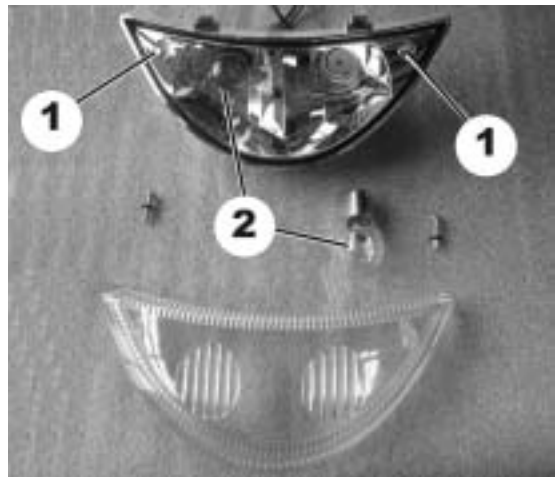

- Reassembly of the headlight takes place in reverse order.
- Check function

6.15 Replacing the front direction indicators



Requirements:

- Phillips screwdriver.

- Remove the seat.
- Remove motor cover.
- Separate battery cable.

• 3-wheel version

- Remove direction indicator screw (1).
- Disconnect direction indicator cable (2) from wiring harness.
- Replace direction indicator.
- Reassembly of the direction indicators takes place in reverse order
- Check functions.

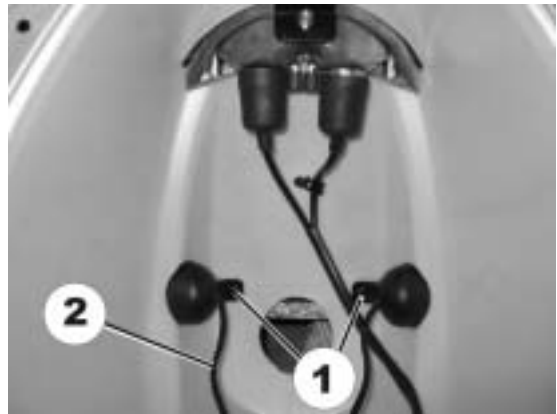

• 4-wheel version

- Remove direction indicator screw (1) on housing.
- Disconnect direction indicator cable (2) from wiring harness.
- Remove screws (3) on indicator glass.
- Remove indicator glass.
- Loosen screws (4) on orange-coloured cap (5) and remove cap.
- Replace lightbulb.
- Reassembly of the direction indicators takes place in reverse order
- Check functions.

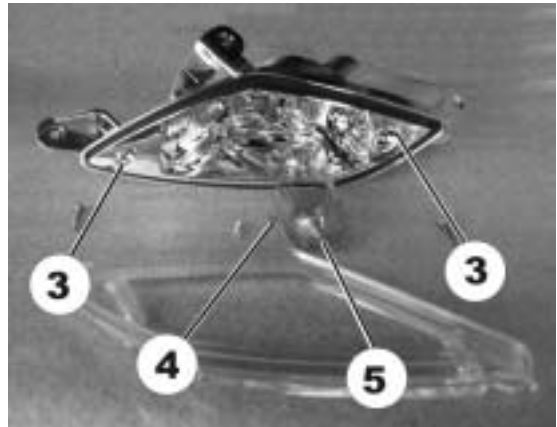
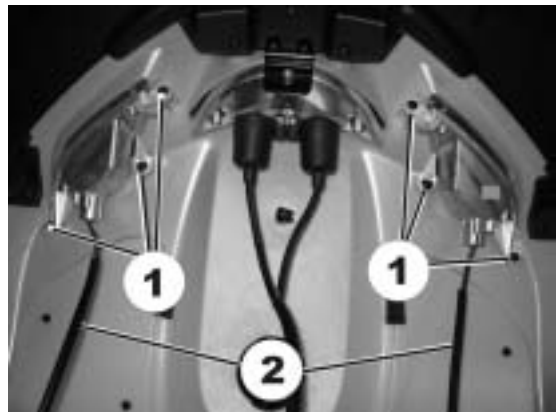

6.16 Replacing centre brake light



CAUTION! Danger of electric shock.

- *Interrupt the power supply by removing the battery plugs before you start work on electric components.*
-

**NOTE:**

When disassembling, note the position of small parts such as screws and washers. Put small parts down so that they can be reassembled in the right sequence.

**Requirements:**

- Phillips screwdriver
-

- Remove the seat.
- Remove motor cover.
- Disconnect both battery plugs (1).

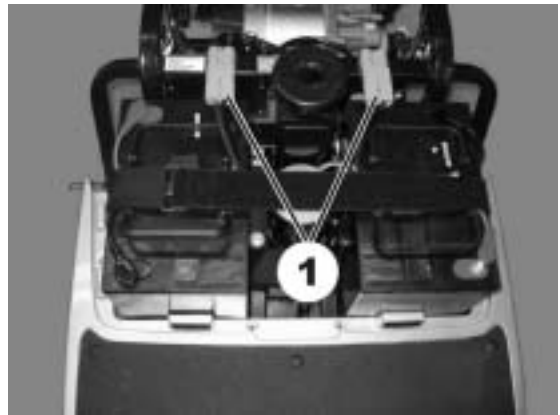

- Disconnect the plug (4).

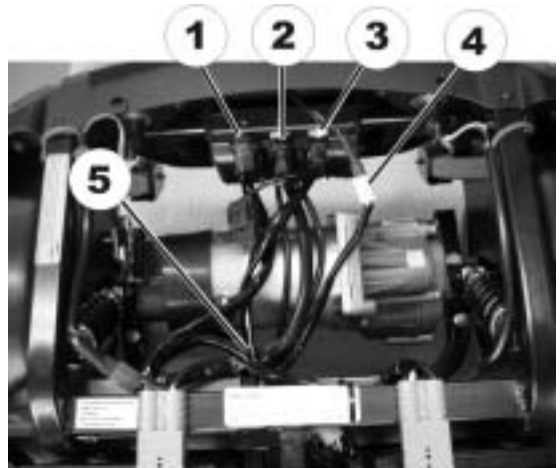

- Remove the bolt (1) on the rear panelling.

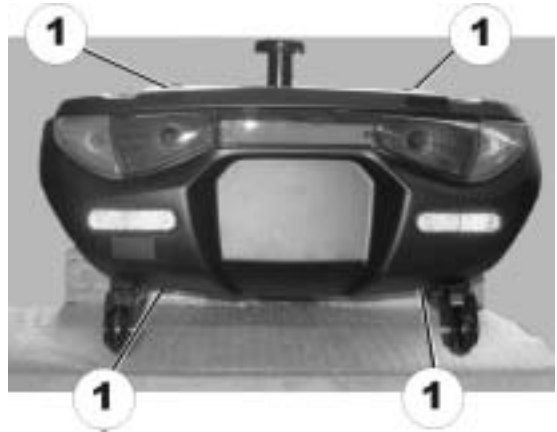

- Lift the rear panelling upwards.
- Remove screws (1) on brake light.
- Replace brake light.



- Reassembly of the brake light takes place in reverse order.
- Check functions (trial run).

6.17 Replacing rear lights/direction indicators



CAUTION! Danger of electric shock.

- *Interrupt the power supply by removing the battery plugs before you start work on electric components.*



NOTE:

When disassembling, note the position of small parts such as screws and washers. Put small parts down so that they can be reassembled in the right sequence.



Requirements:

- Phillips screwdriver

- Remove the seat.
- Remove motor cover.
- Disconnect both battery plugs (1).

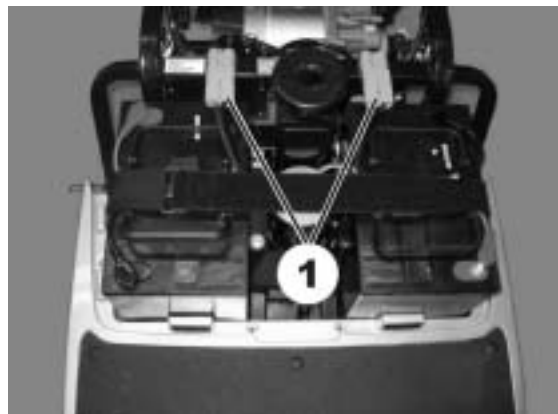

- Remove the bolt (1) on the rear panelling.



- Lift the rear panelling upwards.
- Remove screws (1) on rear light.



- Remove rear light.
- Remove screws (1) on rear light glass.

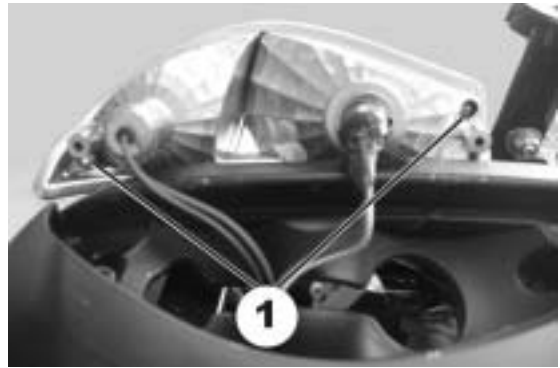

- Remove rear light glass (1).
- Replace lightbulbs (2).

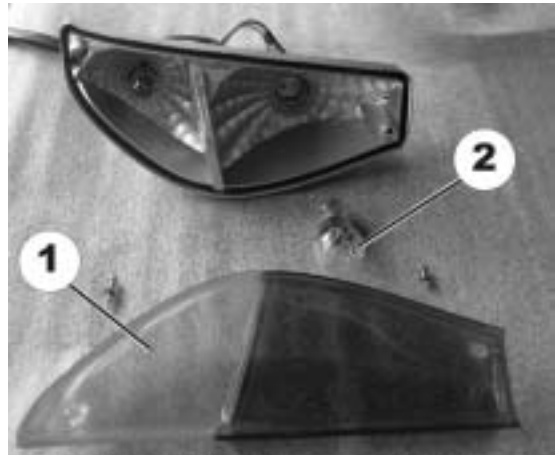

- Reassembly of the rear light/direction indicator takes place in reverse order.
- Check function

6.18 Replacing the electronics module



CAUTION! If the scooter is supported by the support wheels, it will no longer be braked by the motor brake. The scooter can roll away out of control.

- *Place the scooter rear frame on a piece of supporting wood before removing the wheels.*
-



CAUTION! Burn and scald hazard if power cable is short-circuited!

- *Interrupt the power supply by removing the battery plugs before you start work on the electronic system.*
-



CAUTION: Any modifications made to the drive program can affect the drive behaviour and tipping stability!

- *Changes to the drive program may only be carried out by trained Invacare® specialist dealers!*
 - *Invacare can only provide a guarantee for safe driving - especially tipping stability - for unmodified standard drive programs.*
-



CAUTION! Accident hazard.

- *Secure the scooter against rolling away.*
-



NOTE:

The electronic system is supplied with a standard drive program. If you have carried out customer-specific modifications to the drive program, you will have to make these changes again after installing the new electronics module.



NOTE:

When disassembling, note the position of small parts such as screws and washers. Put small parts down so that they can be reassembled in the right sequence.



NOTE:

The plugs on the electronic module cannot be wrongly connected because all plugs have a different size and only fit in one socket.



Requirements:

- Open spanner, 10 mm.
 - Open spanner, 17 mm.
 - Rubber hammer
 - Phillips screwdriver
 - Supporting wooden block
 - To adapt the drive program: programming software or hand programming device and electronics system installation manual, available from Invacare®.
-

- Secure the scooter against rolling away.
- Place supporting wooden block under the frames at battery holder height.
- Remove the seat.
- Remove motor cover.
- Disconnect both battery plugs (1).



- **From the operating manual:**
- Unscrew the rear wheel fixing bolts.
- Remove rear wheels.
- Remove the drive unit. See chapter entitled "Replacing drive motor".

- Remove screws (1) on electronics module.
- Replace electronics module (2).

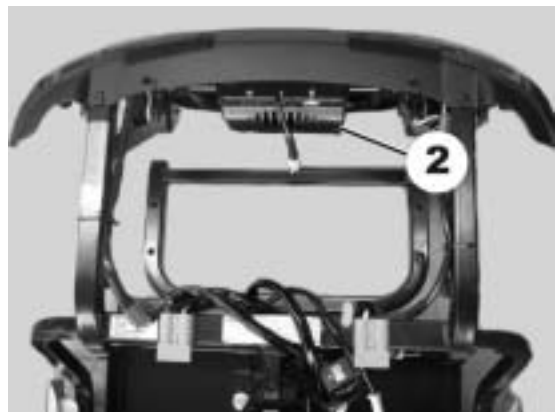
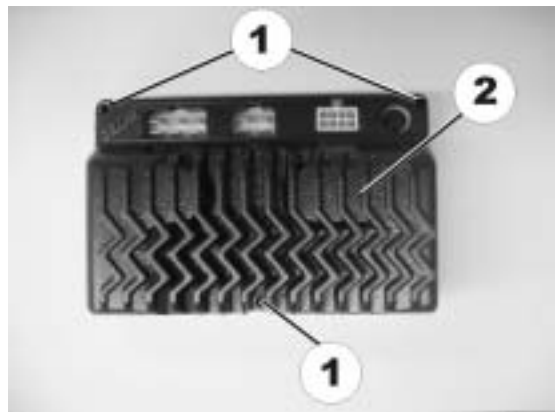

- Reassembly of the drive and the electronics module takes place in reverse order.
- Load drive program onto electronics module. See electronics software description.
- Check all functions (trial run).

6.19 Updating software

Invacare is continuously carrying out further development and improvements to drive programs for electric vehicles. For this reason, you should always check whether the drive program version number is up-to-date when carrying out any repairs or regular maintenance. If a newer version is available, the drive program must be updated. The procedure for updating the drive program is described in the wizard software operating manual.



NOTE:

The electronic system is supplied with a standard drive program. If you have carried out customer-specific modifications to the drive program, you will have to make these changes again after installing the new electronics module.



CAUTION: Any modifications made to the drive program can affect the drive behaviour and tipping stability!

- *Changes to the drive program may only be carried out by trained Invacare® specialist dealers!*
 - *Invacare can only provide a guarantee for safe driving - especially tipping stability - for unmodified standard drive programs.*
-



Requirements:

- Dynamic® Wizard software
 - Operating manual for Wizard software
 - Further requirements, such as a minimum system configuration for the PC used for programming, required programming cables etc. can be taken from the Wizard software operating manual.
-