



# SL-70

## 2-3NM+ Solar Marine Lantern Installation & Service Manual

# SL-70

## 2-3NM+ Solar Marine Lantern

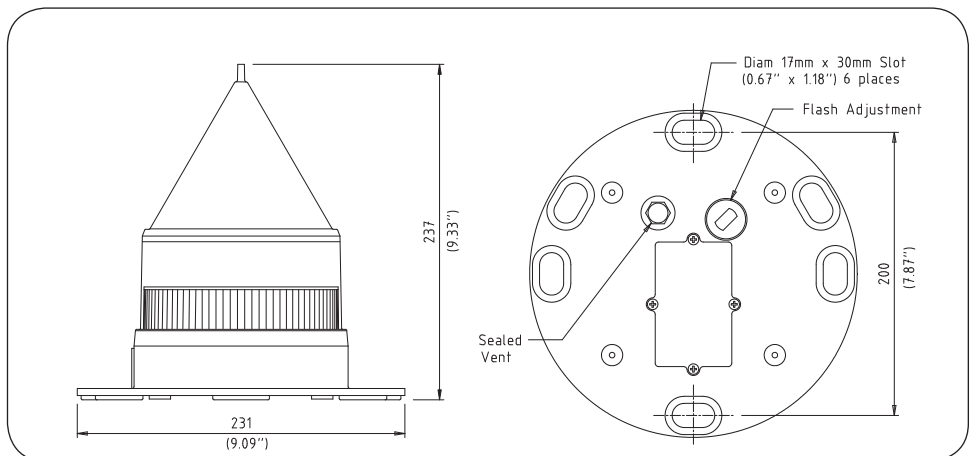
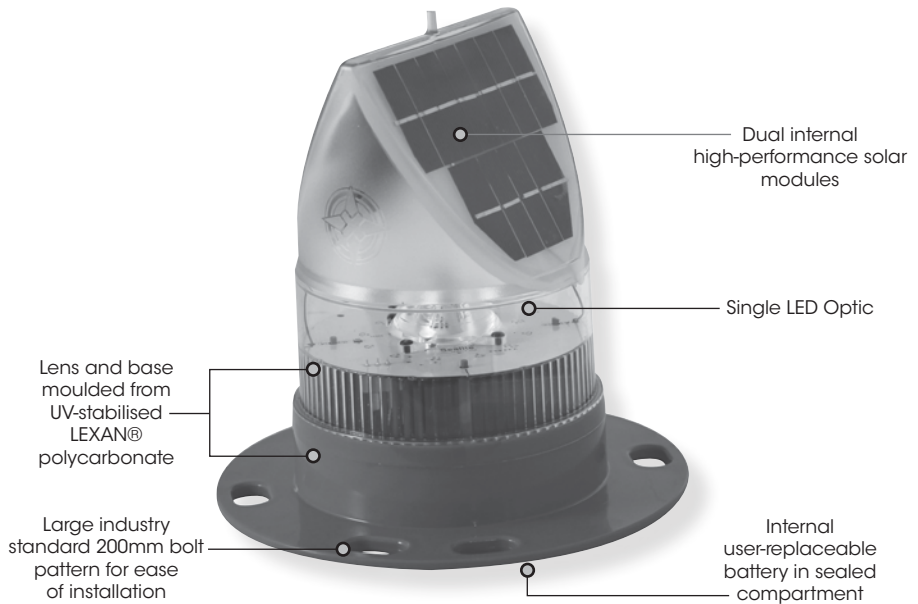

## Table of Contents

<b>Introduction</b> .....	Page 4
<b>Operating Principle</b> .....	Page 4
<b>Technology</b> .....	Page 4
<b>SL-70 Model</b> .....	Page 5
<b>Installation</b> .....	Page 6
<b>Selecting an Intensity/Power Setting</b> .....	Page 7
<b>Selecting a Flash Code</b> .....	Page 7
<b>Flash Codes</b> .....	Page 8
<b>Optional IR Remote Control</b> .....	Page 13
<b>Sealite IR Controller / Universal Remote Compatibility</b> .....	Page 13
<b>IR Controller Functions</b> .....	Page 14
Test Mode / Configure.....	Page 14
Normal Operation.....	Page 14
Read .....	Page 14
Flash Code.....	Page 15
Flash Code Numbers .....	Page 15
Intensity.....	Page 15
Battery Status .....	Page 15
Lux .....	Page 16
Error / Acknowledge Indication .....	Page 17
Configuration Settings.....	Page 17
Hibernation Mode (Advanced Users).....	Page 18
Storage Mode (Advanced Users).....	Page 20
<b>Optional GPS Synchronisation</b> .....	Page 21
<b>Optional AvMesh® Monitoring &amp; Control System</b> .....	Page 22
<b>Optional RF Synchronisation</b> .....	Page 22
<b>Maintenance and Servicing</b> .....	Page 23
<b>Trouble Shooting</b> .....	Page 24
<b>Sealite LED Light Warranty</b> .....	Page 26

Version No.	Description	Date	Approved
3.3	Re launch Catalogue	July 2009	K. Paton
3.4	Logo and Warranty Update	July 2010	K. Paton
3.5	Update: Spec Table	May 2012	J. Dore
3.6	Update: Photometrics	August 2012	J. Dore
4.0	Single LED	May 2014	D. Tomaszewicz
4.1	Spec table update	February 2015	J. Dore

## Introduction

**Congratulations! By choosing to purchase a Sealite lantern you have become the owner of one of the most advanced LED marine lanterns in the world.**

Sealite Pty Ltd has been manufacturing lanterns for over 25 years, and particular care has been taken to ensure your lantern gives years of service.

As a commitment to producing the highest quality products for our customers, Sealite has been independently certified as complying with the requirements of ISO9001:2008 quality management system.

Sealite lanterns comply with requirements of the US Coast Guard in 33 CFR part 66 for Private Aids To Navigation.

By taking a few moments to browse through this booklet, you will become familiar with the versatility of your lantern, and be able to maximise its operating function.

## Operating Principle

The solar module of the lantern converts sunlight to an electrical current that is used to charge the battery. The battery provides power to operate the lantern at night.

The flasher unit has very low current requirements. A microprocessor drives an ultra bright LED through a through a DC/DC converter, which enables the LED's to operate within the manufacturer's specifications. The battery is protected from over-charging within the circuit to ensure maximum battery life.

On darkness, the microprocessor will initiate a program check and after approximately 1 minute begin flashing to the set code

## Technology

***Sealite is the world's fastest growing manufacturer of marine aids to navigation. We employ leading mechanical, optical, hardware & software engineers to create innovative products to service the needs of our customers worldwide, and offer the widest range of solar-powered LED lanterns in the marketplace.***

### Electronics

Sealite employs leading in-house electronic engineers in the design and development of software and related circuitry. All individual electronic components are sourced directly by Sealite procurement staff ensuring that only the highest quality components are used in our products.

### LED Technology

All marine lanterns use the latest advancements in LED (Light Emitting Diode) technology as a light source. The major advantage of LED's over traditional light sources is well established in that they typically have an operational life in excess of 100,000 hours, resulting in substantial savings to maintenance and servicing costs.

### Precision Construction

Commitment to investing in the design and construction of injection-moulded parts including optic lenses, light bases and a range of other components ensures that all Sealite products are of a consistent & superior quality.

### Optical Performance

Sealite manufactures a range of marine LED lenses moulded from multi-cavity dies. The company has superior in-house lens manufacturing capabilities to support outstanding optical performance.

### Award-winning, Patented Technology

Several United States and Australian patent registrations are held on Sealite's range of innovative designs, with other regional patents pending in Canada, United Kingdom and Europe.

# SL-70 Model

*The Sealite SL-70 is exceptional in its unique ability to be able to 'track the sun' and operate reliably in low sunlight conditions. The SL-70 has been proven to operate as a 2-3+ nautical mile compact buoy lantern in various low sunlight environments such as Britain, Canada and Europe.*

## SPECIFICATIONS \* \*

## SL-70

### Light Characteristics

Light Source  
Available Colours  
Typical Maximum Intensity (cd) †  
Visible Range (NM)

Horizontal Output (degrees)  
Vertical Divergence (degrees)  
Available Flash Characteristics  
Intensity Adjustments  
LED Life Expectancy (hours)

### Electrical Characteristics

Current Draw (mA)  
Circuit Protection  
Nominal Voltage (V)  
Autonomy (days)  
Temperature Range

### Solar Characteristics

Solar Module Type  
Output (watts)

### Power Supply

Battery Type  
Battery Capacity (Ah)  
Nominal Voltage (V)

### Physical Characteristics

Body Material  
Lens Material  
Lens Diameter (mm/inches)  
Lens Design  
Mounting  
Height (mm/inches)  
Width (mm/inches)  
Mass (kg/lbs)  
Product Life Expectancy

### Certifications

CE  
  
IALA  
Quality Assurance  
Waterproof

### Intellectual Property

Trademarks  
Warranty \*

### Options Available

LED  
Red, Green, White, Yellow, Blue  
Red - 24.7 Green - 26.6 White - 29.2 Yellow - 18.8  
AT @ 0.74: 2-3+  
AT @ 0.85: 2.3-3.5+  
360  
7  
Up to 256 IALA recommended (user adjustable)  
Multiple intensity settings  
>100,000

Refer to Sealite Power Calculator  
Integrated  
3.6  
>30 (14 hour darkness, 12.5% duty cycle)  
-40 to 80°C

Multicrystalline  
2.5 (2 x 1.25watt)

High grade NiMH  
8  
3.6

LEXAN® Polycarbonate - UV-stabilised  
LEXAN® Polycarbonate - UV-stabilised  
150 / 5<sup>7</sup>/<sub>8</sub>  
Single LED Optic  
200mm bolt pattern  
240 / 9<sup>1</sup>/<sub>2</sub>  
231 / 7<sup>1</sup>/<sub>8</sub>  
1.4 / 3<sup>1</sup>/<sub>8</sub> (SL-70-16AH 1.6 / 3<sup>1</sup>/<sub>2</sub>)  
Up to 12 years

ANSI C63.4-2009. EN61000-6-3:2007. EN1000-6-1:2007.  
IEC61000-4-6:2008. IEC61000-4-3:2010. IEC61000-4-6:2008.  
IEC61000-4-2:2008. MIL-STD-810F. MIL-STD-202G  
Signal colours compliant to IALA E-200-1  
ISO9001:2008  
IP68

SEALITE® is a registered trademark of Sealite Pty Ltd  
3 years

- IR Programmer
- GPS Synchronisation
- 16Ah battery
- 50mm pole mount adapter plate



• Specifications subject to change or variation without notice  
\* Subject to standard terms and conditions  
† Intensity setting subject to solar availability

## Installation

### Charging the Battery

*New lanterns should be left in the sun for 1-2 days to ensure battery is charged before placing in service. Please note, lantern will re-charge even when toggle switch is turned to 'OFF' position.*

### Preferred Installation Location

*For best lantern performance, ensure solar modules are not covered and are in clear view of the sky with no shadows.*

### Lantern Operation

Lantern is activated by ON/OFF Switch. Intensity and flash settings need to be set prior to activation.

1. Remove the marked flash adjustment bung from the base of the lantern and set internal toggle switch to 'ON'.
2. The power and range settings of the lantern are adjusted by setting the DIP switches inside the lantern. Your lantern is normally set to maximum range (see 'Selecting an Intensity/Power Setting' section of this manual).
3. Set rotary switches to the required flash code (see 'Selecting a Flash Code' section of this manual).
4. Replace flash adjustment bung.
5. A sealed vent on the base allows air transfer without moisture intake, and should not be disturbed.
6. To test place dark cover (towel or jacket) on top of lantern to activate sensor, lantern will come on.
7. Ensure that the unit is bolted to an even, flat surface.

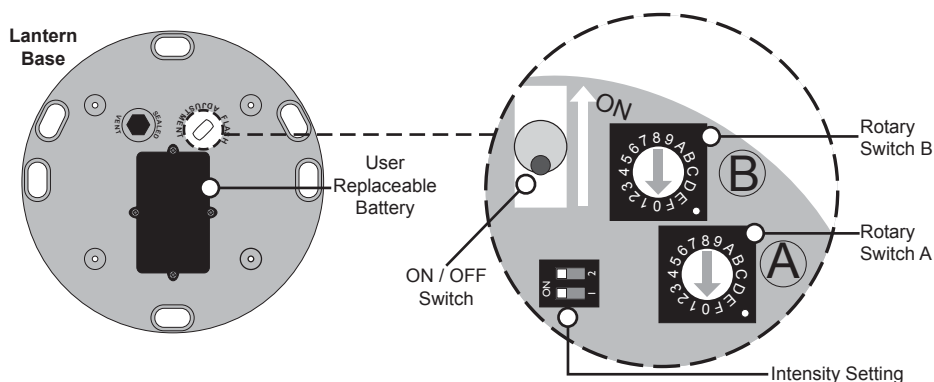

## Selecting an Intensity/Power Setting

Intensity/power settings on Sealite lanterns operate via DIP switches, located near the rotary switches on the flasher unit. The intensity/power settings may be used to reduce the power consumption and intensity of the lantern. Setting the lantern to 25% intensity will reduce the power consumption to 25% of the normal 100% setting and the range by 20% - 40% depending on the maximum intensity. Refer to Sealite power calculator to confirm reduced range.. This setting may be used to adjust the current draw of the light to local sunlight conditions.

The following diagrams indicate intensity/power settings:-

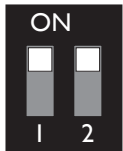

100%

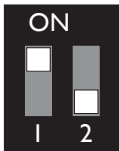

75%



50%



25%

Intensity Setting	Power mA / hour
100%	85mA
75%	64mA
50%	43mA
25%	22mA

### Power Consumption Calculator

<b>Night Hours</b> (use 13.7 if unknown)	<b>Power</b> mA/hour	<b>Duty Cycle</b> (e.g. 20% = 0.2)	<b>Total power used per night</b> (mA)
X		X	=

<b>Total power used per night</b> (mAh)	<b>Solar Panel Charge (mA)</b>	<b>Number of full sunlight hours required to break even</b> (the amount of time it will take for the solar to replace what the light took out overnight)
/	279	=

If the number of Full Sunlight hours is less than 2.5-3.0 hours, please consider reducing the intensity (Power) or reducing the Duty Cycle.

## Selecting a Flash Code - Rotary Switches A & B

All lanterns have 2 rotary switches marked A and B on the flasher unit. Turning the small arrows to the appropriate number or letter will set the code (see 'Flash Codes' section, of this manual). The unit may take up to one minute to activate a new flash code. A comprehensive list of available flash codes is listed on pages in the 'Flash Codes' section of this manual.

Example:

SWITCH	FLASH CODE	ON	OFF
A	B		
A	0	FL 3 S	0.3 2.7

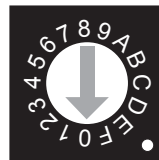

**B**

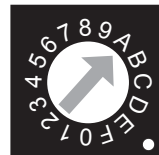

**A**

## Flash Codes

The Sealite SL-70 may be set to any of 256 IALA recommended flash settings which are user-adjustable onsite without the need for external devices.

**SEALITE® code reference is listed by number of flashes**

**For the latest version of this document visit [www.sealite.com](http://www.sealite.com),  
or email [info@sealite.com](mailto:info@sealite.com)**

### Symbols

FL	Flash followed by number Eg. FL 1 S, one flash every second
F	Fixed
Q	Quick flash
VQ	Very quick flash
OC	Occulting; greater period on than off
ISO	Isophase; equal period on and off
LFL	Long flash long
MO	Morse code ( ) contains letter

For example, VQ (6) + LFL 10 S means 6 very quick flashes followed by a long flash, during a 10-second interval.

The amount of power your lantern draws through the night depends on the duty cycle, i.e. the amount of time on as a proportion to the timing cycle. For example, 0.5 seconds on and 4.5 seconds off equals a 10% duty cycle.

It is best to operate at the lowest duty cycle appropriate to the actual needs of the application.

### Recommended Rhythm for Flashing Light - IALA Regions A and B

MARK DESCRIPTION	RHYTHM
<b>Port Hand &amp; Starboard Marks:</b>	Any, other than Composite Group Flashing (2+1)
<b>Preferred Channel Starboard:</b>	Composite Group Flashing (2+1)
<b>Preferred Channel Port:</b>	Composite Group Flashing (2+1)
<b>North Cardinal Mark:</b>	Very quick or quick
<b>East Cardinal Mark:</b>	Very quick (3) every 5 seconds or quick (3) every 10 seconds
<b>South Cardinal Mark:</b>	Very quick (6) + long flash every 10 seconds or quick (6) + long flash every 15 seconds
<b>West Cardinal Mark:</b>	Very quick (9) every 10 seconds or quick (9) every 15 seconds
<b>Isolated Danger Mark:</b>	Group flashing (2)
<b>Safe Water Mark:</b>	Isophase, occulting, one long flash every 10 seconds or Morse Code "A"
<b>Special Marks:</b>	Any, other than those described for Cardinal, Isolated Danger or Safe Water Marks



SWITCH	FLASH CODE	ON	OFF
A	B		
0	0 F (Steady light)		
D	3 VQ 0.5 S	0.2	0.3
E	3 VQ 0.6 S	0.2	0.4
F	3 VQ 0.6 S	0.3	0.3
7	3 Q 1 S	0.2	0.8
8	3 Q 1 S	0.3	0.7
9	3 Q 1 S	0.4	0.6
A	3 Q 1 S	0.5	0.5
8	4 Q 1 S	0.8	0.2
B	3 Q 1.2 S	0.3	0.9
9	4 Q 1.2 S	0.5	0.7
C	3 Q 1.2 S	0.6	0.6
F	4 FL 1.5 S	0.2	1.3
1	0 FL 1.5 S	0.3	1.2
0	5 FL 1.5 S	0.4	1.1
0	4 FL 1.5 S	0.5	1.0
2	0 FL 2 S	0.2	1.8
3	0 FL 2 S	0.3	1.7
4	0 FL 2 S	0.4	1.6
5	0 FL 2 S	0.5	1.5
6	0 FL 2 S	0.7	1.3
7	0 FL 2 S	0.8	1.2
1	2 ISO 2 S	1.0	1.0
8	0 FL 2.5 S	0.3	2.2
9	0 FL 2.5 S	0.5	2.0
D	6 FL 2.5 S	1.0	1.5
1	5 FL 3 S	0.2	2.8
A	0 FL 3 S	0.3	2.7
2	5 FL 3 S	0.4	2.6
B	0 FL 3 S	0.5	2.5
3	5 FL 3 S	0.6	2.4
C	0 FL 3 S	0.7	2.3
D	0 FL 3 S	1.0	2.0
2	2 ISO 3 S	1.5	1.5
5	4 OC 3 S	2.0	1.0
E	2 OC 3 S	2.5	0.5
4	6 OC 3.5 S	2.5	1.0
4	5 FL 4 S	0.2	3.8
5	5 FL 4 S	0.3	3.7
E	0 FL 4 S	0.4	3.6
F	0 FL 4 S	0.5	3.5
6	5 FL 4 S	0.6	3.4
0	1 FL 4 S	0.8	3.2
1	1 FL 4 S	1.0	3.0
2	1 FL 4 S	1.5	2.5
3	2 ISO 4 S	2.0	2.0
3	6 OC 4 S	2.5	1.5
F	2 OC 4 S	3.0	1.0
3	1 FL 4.3 S	1.3	3.0
8	5 FL 5 S	0.2	4.8
4	1 FL 5 S	0.3	4.7
5	1 FL 5 S	0.5	4.5
9	5 FL 5 S	0.9	4.1
6	1 FL 5 S	1.0	4.0

SWITCH	FLASH CODE	ON	OFF
A	B		
7	1 FL 5 S	1.5	3.5
4	2 ISO 5 S	2.5	2.5
8	2 LFL 5 S	2.0	3.0
0	3 OC 5 S	3.0	2.0
1	3 OC 5 S	4.0	1.0
2	3 OC 5 S	4.5	0.5
C	6 FL 6 S	0.2	5.8
B	5 FL 6 S	0.3	5.7
C	5 FL 6 S	0.4	5.6
8	1 FL 6 S	0.5	5.5
9	1 FL 6 S	0.6	5.4
A	1 FL 6 S	1.0	5.0
7	5 FL 6 S	1.2	4.8
B	1 FL 6 S	1.5	4.5
5	2 ISO 6 S	3.0	3.0
9	2 LFL 6 S	2.0	4.0
6	4 OC 6 S	4.0	2.0
3	3 OC 6 S	4.5	1.5
4	3 OC 6 S	5.0	1.0
A	4 FL 7 S	1.0	6.0
9	6 FL 7 S	2.0	5.0
5	6 OC 7 S	4.5	2.5
D	5 FL 7.5 S	0.5	7.0
C	1 FL 7.5 S	0.8	6.7
E	5 FL 8 S	0.5	7.5
B	4 FL 8 S	1.0	7.0
6	2 ISO 8 S	4.0	4.0
A	2 LFL 8 S	2.0	6.0
6	6 OC 8 S	5.0	3.0
B	2 LFL 8 S	3.0	5.0
F	5 FL 9 S	0.9	8.1
C	4 FL 9 S	1.0	8.0
7	6 OC 9 S	6.0	3.0
0	6 FL 10 S	0.2	9.8
1	6 FL 10 S	0.3	9.7
D	1 FL 10 S	0.5	9.5
2	6 FL 10 S	0.8	9.2
E	1 FL 10 S	1.0	9.0
1	4 FL 10 S	1.5	8.5
C	2 LFL 10 S	2.0	8.0
D	2 LFL 10 S	3.0	7.0
7	2 ISO 10 S	5.0	5.0
2	4 LFL 10 S	4.0	6.0
8	6 OC 10 S	6.0	4.0
5	3 OC 10 S	7.0	3.0
6	3 OC 10 S	7.5	2.5
F	1 FL 12 S	1.2	10.8
D	4 FL 12 S	2.5	9.5
3	4 LFL 12 S	2.0	10.0
0	2 FL 15 S	1.0	14.0
4	4 LFL 15 S	4.0	11.0
7	4 OC 15 S	10	5.0
A	6 LFL 20 S	2.0	18.0
E	4 FL 26 S	1.0	25.0

SWITCH	FLASH CODE	ON	OFF	ON	OFF
<b>A</b>	<b>B</b>				
0	A FL (2) 4 S	0.5	1.0	0.5	2.0
E	B VQ (2) 4 S	0.2	1.0	0.2	2.6
1	A FL (2) 4.5 S	0.3	1.0	0.3	2.9
2	A FL (2) 4.5 S	0.4	1.0	0.4	2.7
3	A FL (2) 4.5 S	0.5	1.0	0.5	2.5
F	9 FL (2) 5 S	0.2	0.8	0.2	3.8
2	C FL (2) 5 S	0.2	1.2	0.2	3.4
4	A FL (2) 5 S	0.4	0.6	0.4	3.6
0	7 FL (2) 5 S	0.5	1.0	0.5	3.0
1	7 FL (2) 5 S	1.0	1.0	1.0	2.0
9	B Q (2) 5 S	0.3	0.7	0.3	3.7
2	9 Q (2) 5 S	0.5	0.5	0.5	3.5
5	A FL (2) 5.5 S	0.4	1.4	0.4	3.3
7	8 FL (2) 6 S	0.3	0.6	1.0	4.1
A	A FL (2) 6 S	0.3	0.9	0.3	4.5
6	A FL (2) 6 S	0.3	1.0	0.3	4.4
7	A FL (2) 6 S	0.4	1.0	0.4	4.2
9	9 FL (2) 6 S	0.5	1.0	0.5	4.0
2	8 FL (2) 6 S	0.8	1.2	0.8	3.2
3	7 FL (2) 6 S	1.0	1.0	1.0	3.0
3	9 Q (2) 6 S	0.3	0.7	0.3	4.7
A	9 FL (2) 7 S	1.0	1.0	1.0	4.0
7	B FL (2) 8 S	0.4	0.6	2.0	5.0
8	A FL (2) 8 S	0.4	1.0	0.4	6.2
4	7 FL (2) 8 S	0.5	1.0	0.5	6.0
8	8 FL (2) 8 S	0.8	1.2	2.4	3.6
5	7 FL (2) 8 S	1.0	1.0	1.0	5.0
4	C OC (2) 8 S	3.0	2.0	1.0	2.0
5	C OC (2) 8 S	5.0	1.0	1.0	1.0
F	B VQ (2) 8 S	0.2	1.0	0.2	6.6
9	A FL (2) 10 S	0.4	1.6	0.4	7.6
9	8 FL (2) 10 S	0.5	0.5	1.5	7.5
6	7 FL (2) 10 S	0.5	1.0	0.5	8.0
7	7 FL (2) 10 S	0.5	1.5	0.5	7.5
6	9 FL (2) 10 S	0.5	2.0	0.5	7.0
8	7 FL (2) 10 S	0.8	1.2	0.8	7.2
B	9 FL (2) 10 S	1.0	1.0	1.0	7.0
9	7 FL (2) 10 S	1.0	1.5	1.0	6.5
4	9 Q (2) 10 S	0.6	0.4	0.6	8.4
B	A FL (2) 12 S	0.4	1.0	0.4	10.2
C	9 FL (2) 12 S	0.5	1.0	0.5	10.0
D	9 FL (2) 12 S	1.5	2.0	1.5	7.0
A	8 FL (2) 15 S	0.5	1.5	2.0	11.0
A	7 FL (2) 15 S	1.0	2.0	1.0	11.0
8	B Q (2) 15 S	0.2	0.8	0.2	13.8
C	A FL (2) 20 S	1.0	3.0	1.0	15.0
D	A FL (2) 25 S	1.0	1.0	1.0	22.0

SWITCH	FLASH CODE	ON	OFF	ON	OFF	ON	OFF
<b>A</b>	<b>B</b>						
7	9 Q (3) 5 S	0.5	0.5	0.5	0.5	0.5	2.5
5	9 VQ (3) 5 S	0.2	0.3	0.2	0.3	0.2	3.8
0	C VQ (3) 5 S	0.3	0.2	0.3	0.2	0.3	3.7
E	9 VQ (3) 5 S	0.3	0.3	0.3	0.3	0.3	3.5
3	C FL (3) 6 S	0.5	1.0	0.5	1.0	0.5	2.5
2	B FL (2+1) 6 S	0.3	0.4	0.3	1.2	0.3	3.5

SWITCH	FLASH CODE	ON	OFF	ON	OFF	ON	OFF	
A	B							
A	B	Q (3) 6 S	0.3	0.7	0.3	0.7	0.3	3.7
F	A	FL (3) 8 S	0.5	1.0	0.5	1.0	0.5	4.5
0	B	FL (3) 9 S	0.3	1.0	0.3	1.0	0.3	6.1
B	7	FL (3) 9 S	0.8	1.2	0.8	1.2	0.8	4.2
B	8	FL (3) 10 S	0.3	0.7	0.3	0.7	0.9	7.1
C	8	FL (3) 10 S	0.4	0.6	0.4	0.6	1.2	6.8
C	B	FL (3) 10 S	0.5	0.5	0.5	0.5	0.5	7.5
C	7	FL (3) 10 S	0.5	1.5	0.5	1.5	0.5	5.5
D	B	FL (3) 10 S	0.6	0.6	0.6	0.6	0.6	7.0
D	7	FL (3) 10 S	1.0	1.0	1.0	1.0	1.0	5.0
3	8	FL (2+1) 10 S	0.5	0.7	0.5	2.1	0.5	5.7
8	9	OC (3) 10 S	5.0	1.0	1.0	1.0	1.0	1.0
B	B	Q (3) 10 S	0.3	0.7	0.3	0.7	0.3	7.7
D	8	FL (2 + 1) 10 S	0.5	0.5	0.5	0.5	1.5	6.5
1	B	FL (3) 12 S	0.5	1.5	0.5	1.5	0.5	7.5
E	A	FL (3) 12 S	0.5	2.0	0.5	2.0	0.5	6.5
E	7	FL (3) 12 S	0.8	1.2	0.8	1.2	0.8	7.2
B	6	FL (3) 12 S	1.0	1.0	1.0	3.0	1.0	5.0
4	8	FL (2+1) 12 S	0.8	1.2	0.8	2.4	0.8	6.0
5	8	FL (2+1) 12 S	1.0	1.0	1.0	4.0	1.0	4.0
1	8	FL (2+1) 13.5 S	1.0	1.0	1.0	4.0	1.0	5.5
F	7	FL (3) 15 S	0.3	1.7	0.3	1.7	0.3	10.7
9	D	FL (3) 15 S	0.4	1.0	0.4	1.0	0.4	11.8
0	8	FL (3) 15 S	0.5	1.5	0.5	1.5	0.5	10.5
F	8	FL (2+1) 15 S	0.6	0.3	0.6	0.3	1.4	11.8
0	9	FL (2+1) 15 S	0.7	0.5	0.7	0.5	1.9	10.7
1	9	FL (2+1) 15 S	0.7	0.7	0.7	0.7	2.1	10.1
6	8	FL (2+1) 15 S	1.0	2.0	1.0	5.0	1.0	5.0
1	C	VQ (3) 15 S	0.1	0.5	0.1	0.5	0.1	13.7
4	B	FL (3) 20 S	0.5	3.0	0.5	3.0	0.5	12.5
3	B	FL (3) 20 S	0.5	1.5	0.5	1.5	0.5	15.5
5	B	FL (3) 20 S	0.8	1.2	0.8	1.2	0.8	15.2
6	B	FL (3) 20 S	1.0	1.0	1.0	1.0	1.0	15.0

SWITCH	FLASH CODE	ON	OFF	ON	OFF	ON	OFF	ON	OFF
A	B								
B	F	VQ (4) 4 S	0.3	0.3	0.3	0.3	0.3	0.3	2.3
B	D	Q (4) 6 S	0.3	0.7	0.3	0.7	0.3	0.7	2.7
8	D	Q (4) 6 S	0.4	0.6	0.4	0.6	0.4	0.6	2.6
1	D	FL (4) 10 S	0.5	1.0	0.5	1.0	0.5	1.0	5.0
2	D	FL (4) 10 S	0.8	1.2	0.8	1.2	0.8	1.2	3.2
F	E	Q (4) 10 S	0.3	0.7	0.3	0.7	0.3	0.7	6.7
B	E	FL (4) 12 S	0.3	1.7	0.3	1.7	0.3	1.7	5.7
4	F	FL (4) 12 S	0.5	0.5	0.5	0.5	0.5	0.5	8.5
C	E	FL (4) 12 S	0.5	1.5	0.5	1.5	0.5	1.5	5.5
3	D	FL (4) 12 S	0.8	1.2	0.8	1.2	0.8	1.2	5.2
A	D	Q (4) 12 S	0.3	0.7	0.3	0.7	0.3	0.7	8.7
4	D	FL (4) 15 S	0.5	1.5	0.5	1.5	0.5	1.5	8.5
8	E	FL (4) 15 S	1.0	1.0	1.0	1.0	1.0	1.0	8.0
7	D	FL (4) 15 S	1.5	0.5	0.5	0.5	0.5	0.5	10.5
D	E	FL (4) 16 S	0.5	1.5	0.5	1.5	0.5	1.5	9.5
C	D	FL (4) 20 S	0.3	3.0	0.3	3.0	0.3	3.0	9.8
5	D	FL (4) 20 S	0.5	1.5	0.5	1.5	0.5	1.5	13.5
0	D	FL (4) 20 S	0.5	1.5	0.5	1.5	0.5	4.5	10.5
3	F	FL (4) 20 S	1.5	1.5	1.5	1.5	1.5	1.5	9.5
0	F	Q (4) 20 S	0.5	0.5	0.5	0.5	0.5	0.5	16.5
E	E	Q (4) 28 S	0.5	0.5	0.5	0.5	0.5	0.5	24.5
6	F	FL (4) 30 S	0.5	0.5	0.5	0.5	0.5	0.5	26.5

SWITCH	FLASH CODE	ON	OFF	ON	OFF	ON	OFF	ON	OFF	ON	OFF	
A	B											
D	D	Q (5) 7 S	0.3	0.7	0.3	0.7	0.3	0.7	0.3	0.7	0.3	2.7
E	D	Q (5) 10 S	0.3	0.7	0.3	0.7	0.3	0.7	0.3	0.7	0.3	5.7
E	8	FL (5) 12 S	0.5	1.5	0.5	1.5	0.5	1.5	0.5	1.5	0.5	3.5
5	F	FL (5) 20 S	0.5	0.5	0.5	0.5	0.5	0.5	0.5	0.5	0.5	15.5
9	F	FL (5) 20 S	0.8	1.2	0.8	1.2	0.8	1.2	0.8	1.2	0.8	11.2
9	E	FL (5) 20 S	1.0	1.0	1.0	1.0	1.0	1.0	1.0	1.0	1.0	11.0

SWITCH	FLASH CODE	ON	OFF	ON	OFF	ON	OFF	ON	OFF	ON	OFF	ON	OFF
A	B												
F	D	Q (6) 10 S	0.3	0.7	0.3	0.7	0.3	0.7	0.3	0.7	0.3	0.7	4.7
A	F	FL (6) 15 S	0.3	0.7	0.3	0.7	0.3	0.7	0.3	0.7	0.3	0.7	9.7
7	F	FL (6) 15 S	0.5	1.0	0.5	1.0	0.5	1.0	0.5	1.0	0.5	1.0	7.0

SWITCH	FLASH CODE	ON	OFF	ON	OFF	ON	OFF	ON	OFF	ON	OFF	ON	OFF	ON	OFF
A	B														
6	E	VQ (6) + LFL 10 S	0.2	0.3	0.2	0.3	0.2	0.3	0.2	0.3	0.2	0.3	0.2	0.3	2.0
7	E	VQ (6) + LFL 10 S	0.3	0.3	0.3	0.3	0.3	0.3	0.3	0.3	0.3	0.3	0.3	0.3	2.0
2	F	Q (6) + LFL 15 S	0.2	0.8	0.2	0.8	0.2	0.8	0.2	0.8	0.2	0.8	0.2	0.8	2.0
2	E	Q (6) + LFL 15 S	0.3	0.7	0.3	0.7	0.3	0.7	0.3	0.7	0.3	0.7	0.3	0.7	2.0
3	E	Q (6) + LFL 15 S	0.6	0.6	0.6	0.6	0.6	0.6	0.6	0.6	0.6	0.6	0.6	0.6	2.0
8	F	VQ (6) + LFL 15 S	0.3	0.3	0.3	0.3	0.3	0.3	0.3	0.3	0.3	0.3	0.3	0.3	2.0

SWITCH	FLASH CODE	ON	OFF	ON	OFF	ON	OFF	ON	OFF	ON	OFF	ON	OFF	ON	OFF	ON	OFF
A	B																
4	E	VQ (9) 10 S	0.2	0.3	0.2	0.3	0.2	0.3	0.2	0.3	0.2	0.3	0.2	0.3	0.2	0.3	0.2
5	E	VQ (9) 10 S	0.3	0.3	0.3	0.3	0.3	0.3	0.3	0.3	0.3	0.3	0.3	0.3	0.3	0.3	0.3
1	F	Q (9) 15 S	0.2	0.8	0.2	0.8	0.2	0.8	0.2	0.8	0.2	0.8	0.2	0.8	0.2	0.8	0.2
0	E	Q (9) 15 S	0.3	0.7	0.3	0.7	0.3	0.7	0.3	0.7	0.3	0.7	0.3	0.7	0.3	0.7	0.3
1	E	Q (9) 15 S	0.6	0.6	0.6	0.6	0.6	0.6	0.6	0.6	0.6	0.6	0.6	0.6	0.6	0.6	0.6

SWITCH	FLASH CODE	ON	OFF	ON	OFF	ON	OFF	ON	OFF
A	B								
MORSE CODE ( ) INDICATES LETTER									
7	8	MO (A) 6 S	0.3	0.6	1.0	4.1			
7	B	MO (A) 8 S	0.4	0.6	2.0	5.0			
8	8	MO (A) 8 S	0.8	1.2	2.4	3.6			
B	8	MO (U) 10 S	0.3	0.7	0.3	0.7	0.9	7.1	
C	8	MO (U) 10 S	0.4	0.6	0.4	0.6	1.2	6.8	
D	8	MO (U) 10 S	0.5	0.5	0.5	0.5	1.5	6.5	
9	8	MO (A) 10 S	0.5	0.5	1.5	7.5			
8	9	MO (D) 10 S	5.0	1.0	1.0	1.0	1.0	1.0	
A	8	MO (A) 15 S	0.5	1.5	2.0	11.0			
F	8	MO (U) 15 S	0.6	0.3	0.6	0.3	1.4	11.8	
0	9	MO (U) 15 S	0.7	0.5	0.7	0.5	1.9	10.7	
1	9	MO (U) 15 S	0.7	0.7	0.7	0.7	2.1	10.1	
7	D	MO (B) 15 S	1.5	0.5	0.5	0.5	0.5	0.5	10.5

# Optional IR Remote Control

The IR remote is used to communicate with Sealite lighting products that have an IR sensor fitted. The remote control is used for the following functions:

- Flash Code: read the current flash code, configure a new flash code.
- Lamp Intensity: read the current lamp intensity, configure a new intensity level.
- Ambient Light Thresholds: read the current light thresholds, configure new ambient light thresholds.
- Perform a battery health check.

On receiving a valid key signal from the IR Remote, the light will flash once.

The user should wait until the light responds to each keypress before pressing another key. If there is no response to the keypress after 3 seconds, it has not been detected by the light and the key can be pressed again.

If an invalid key is detected, the light will flash quickly 5 times. In this case, the command will have to be restarted.

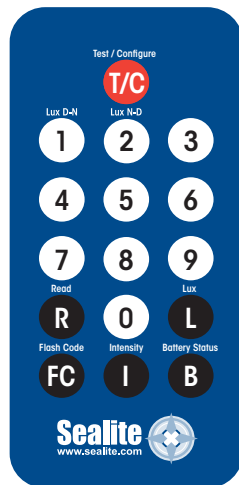

## Sealite IR Controller / Universal Remote Compatibility

If you lose your Sealite IR Controller, the following Universal Remote Controller has been tested for compatibility: RCA Type RCR312WR programmed for Phillips TV Type Code 10054

Sealite Key	Universal Remote Key
T	Power
1	1
2	2
3	3
4	4
5	5
6	6
7	7
8	8
9	9
0	0
R	Channel+
L	Mute
FC	Volume+
I	Volume-
B	Channel-



## IR Controller Functions

### Test Mode / Configure



Pressing the T/C button for upto 5 seconds places the light in Test Mode. The light will flash once in response to the T/C button being pressed and then turn off.













### Normal Operation

The light will return to normal operation once it has not detected a valid key press for 30 seconds. The light will flash once to indicate it is returning to normal operation.

### Read

Pressing the Read followed by one of the configuration keys shall cause the light to flash the configured value.

#### **Example Key Sequences:**

-    The light flashes the 'IR Remote' number belonging to the currently set Flash Code. Refer to the Flash Code tables to match the 'IR Remote' flash number to the Flash Code.
-    The light flashes the current intensity setting: 1 flash for 25%, 2 for 50%, 3 for 75% and 4 for 100%.
-    The light flashes the current battery status.
-    The light flashes the sunset level in Lux, followed by a 2 second gap, followed by the sunrise level. Levels are in the range of 1 to 9.



### Flash Code

**FC**

This key sets the flash code on the light.

**Example Key sequence:**



This sets the flash code to value 123. The light responds by flashing the flash code value.

### Flash Code Numbers

The lamp flashes numbers as follows: Hundreds, Tens, Ones. A value of 125 will be flashed as: 1 flash, followed by a delay, 2 flashes, followed by a delay, 5 flashes.

The flash for number 0 is one long flash.

For example if the current Flash Code is set to 51 via the AB switches, the lamp will flash number 081. For a flash code set to 01, the lamp will flash 001.

### Intensity

This function sets the light intensity. Valid intensity values are 1 for 25%, 2 for 50%, 3 for 75% and 4 for 100%.

**I**

**Example Key sequence:**



This sets the light intensity to 25%.

### Battery Status

**B**

This function reads the battery status. The response from the light is High Voltage: 4 flashes, Good Voltage: 3 flashes, Low Voltage 2 flashes, Cutoff Voltage or below: 1 flash.

**Example Key sequence:**



**Lux**



This key sets the ambient light threshold levels.

The format is



Where 'x' is the desired setting from the table below.

There are 5 programmable lux levels which are set together for the sunset and sunrise transitions.

Level	Sunset (Dusk)	Sunrise (Dawn)
1	64	100
<b>2*</b>	<b>100</b>	<b>150</b>
3	150	240
4	240	370
5	370	600
<b>* Default / Factory Preset</b>		

**Example key sequence:**



Assume the current Lux settings are at the factory preset values of 2.

This sets the ambient light level to be lower than the default 100 lux. The light will turn on when its surroundings are darker.

The light responds by acknowledgement with a long flash.





### **Error / Acknowledge Indication**

If the key sequence is invalid, or an out of bounds value is attempted to be set, the light flashes 5 times for 1 second. (The command then needs to be sent from the start.)

**Example key sequence:** (Set the intensity level to 5 – undefined.)



The light flashes 5 times for 1 second.

When a key sequence has been entered successfully the light will respond acknowledgement with a long 1 second flash.

### **Configuration Settings**

The intensity and flash codes can be changed using the switches on the lamp circuit board or with the IR Remote Control. The lamp intensity and flash code settings are set to the last detected change, carried out with the IR Remote Control or by changing the switch positions.

**Example #1:** If the intensity is set at 100% with the intensity switches, and is then set to 50% using the IR Remote Control, the intensity setting will change to 50%. If the intensity is then set to 75% using the switches, the new intensity value will be 75%.

In order to change intensity settings using the IR Remoter Control, the lamp must be powered.

The lamp can detect a change in switch settings if they are changed while the light is powered down.

**Example #2:** The flash code is set according to the switch settings: A=5, B = 1. The operator changes the flash code to 65 (A=4, B=1) using the IR Remote Control. The new flash code is now configured to A=4, B=1. The lamp is powered down and the operator changes the flash code switches to A=3, B=1 and powers on the light. The new flash code is now A=3, B=1. If the flash code is read from the light using the IR Remote Control, the lamp will flash 49 which is the corresponding number for switches A=3, B=1.

Use the IR Remote Control to read the current lamp intensity setting and flash code.

## Hibernation Mode (Advanced users) – only available for lanterns fitted with GPS



For situations where the lantern is put into storage for a known period, the IR Remote control can be used to configure the lantern into Hibernation Mode for a user programmable date range.

Hibernation Mode maximises conservation of the battery power by disabling the light (will not activate at night) and shutting off the GPS receiver to rely on the internal clock for date checking. The IR sensor is still monitored in hibernation mode. Power consumption is only bettered by physically disconnecting the battery supply.

Hibernation Mode is defined by a start date and end date that are programmed into the lantern via the IR Remote Control.

### Using the IR Remote Control

The lantern must be in Test Mode prior to pressing any of the following key sequences. However, the lantern will return to Normal Operation if it has not detected a valid key press for a period of 15 seconds. When the lantern exits from Test Mode it will either enter Dusk to Dawn mode, Hibernation mode, or Storage Mode, if enabled.

### Store Hibernation Mode Date Range

The following details the key press sequence that defines the start and end dates of Hibernation Mode:



where **ddmm** is the numerical representation of the month (01=January, 08=August) of the start date, and **DDMM** is the numerical representation of the end date.

e.g 9th of December is represented by the number sequence 0912.

The lantern will respond by flashing an acknowledge long flash.

This operation only stores the start & end dates into the lantern's memory and Hibernation Mode still must be enabled to commence its operation.

### Enable Hibernation Mode

Pressing the following key sequence will enable (turn on) Hibernation Mode:



and the lantern will respond with a single flash.

The Lantern will take a new GPS reading, determine the calendar month, and then enter Hibernation Mode and depending on the current calendar month setting will either Hibernate or enter Dusk-to-Dawn mode.

By default, Hibernation mode is disabled. Note you can only use this command once a valid hibernation start & end date has been stored in the lantern.

### Disable Hibernation / Hibernation Modes

Pressing the following key sequence will disable (turn off) both Hibernation Mode and Seasonal Hibernation:



and the lantern will respond with a single long flash.

The Lantern will disable Hibernation Mode and enter Dusk-to-Dawn Mode.

### Momentarily Wake Up from Hibernation Mode

Pressing the  button will wake up the lantern.

At which point the lantern will remain awake for a further 15 seconds to process other commands from the IR Controller. If no IR commands are received for a period of 15 seconds, the lantern will return to Hibernation mode.

### Read Stored Hibernation Dates

By pressing the following key sequence the lantern will respond with the stored start and end dates for Hibernation:



### Read Hibernation Mode Status

By pressing the following key sequence the lantern will respond with status of Hibernation mode.





Where:

- A single long flash = hibernation mode is Enabled
- Two quick flashes = hibernation mode is Disabled.

### User Case Example: Configuring the lantern for Hibernation

In this example, we want the lantern to hibernate each year from Dec 10th, through to February 15th, and the lantern is located inside a storage warehouse.

The required key sequence is:

Command	IR Controller Key Press
Store the Hibernation Date Range	
Enable Hibernation	



### **Storage Mode (Advanced users)**

For situations where the lantern is put into storage but with access to daylight, the IR Remote control can be used to configure the lantern into Storage Mode.

This mode manually forces the lantern to turn off, but with access to daylight it will still charge battery pack. However the lantern will not keep track of the date.

In Storage Mode, the GPS is disabled however the lantern will still respond to IR commands.

The lantern will automatically enter Storage Mode, if it is hibernating and it has not detected any light for 20 hours.

### **Enter Storage Mode**

By pressing the following key sequence the lantern will enter Storage Mode:



The lantern will leave storage mode when exposed to daylight or if the power switch is turned OFF and ON again.



## Optional GPS Synchronisation

The lanterns are available with optional GPS fitted and provide the user with the ability to install independently operating lanterns that all flash in synchronisation.

No additional power supplies, aerials or control systems are required, and with its microprocessor-based system, the GPS option is specifically designed to provide maximum reliability and performance over a wide range of environmental conditions.

### Operating Principle

Each light operates independently and requires no operator intervention. A minimum of 4 satellites need to be in view for the built-in GPS receiver to collect time data. At dusk, the light sensor will turn the light on. If time data is available the light will come on synchronised to every other light with the same selected flash code.

Synchronisation is achieved using an internal algorithm based on the highly accurate time base and time data received from the satellites. The satellite data is provided from a number of earth stations using atomic clocks as the time base. Continuous self-checking ensures that the light will continue to run in synchronisation.

### Light Activation

At power-up the microprocessor checks that the internal GPS module is programmed correctly and is able to provide valid time base and time data.

Once outside with a clear view of the sky, valid data should become available within 20 minutes.

### Daylight Operation

During daylight hours the microprocessor is in idle mode to reduce power consumption. Time data continues to be updated once per second. The microprocessor will automatically exit the idle mode as soon as dark conditions are detected.

### Dark Operation

When dark conditions are detected the light:

- Checks for valid time data and is turned on after a delay based on the current time and the length of the selected flash code;
- If valid time data is not detected the light will turn on after approximately 10 seconds. This light will not be synchronised.
- If the light turns on unsynchronised it will continually check for valid time data. Once valid data is found the light will automatically synchronise.

**Note:** Lights will not synchronise if different flash codes are selected.

## **Optional AvMesh® Monitoring & Control System**

Sealite's AvMesh® Monitoring and Control Systems may be fitted to the lantern enabling users to remotely modify the setup of their lantern via handheld radio controller.

Please contact Sealite for instructions on how to use the AvMesh® Monitoring & Control System.



## Maintenance and Servicing

Designed to be maintenance free, the SL-70 requires minimal attention, though the following maintenance and servicing information is provided to help ensure the life of your Sealite product.

1. **Cleaning Solar Panels** - occasional cleaning of the solar panels may be required. Using a cloth and warm soapy water, wipe off any foreign matter before rinsing the panels with fresh water.
2. **Battery Check** - inspection of batteries should be performed every three years (minimum) to ensure that the charger, battery and ancillary electronics are functioning correctly. Using a voltage meter, check that the battery voltage is at least 3.6 volts under 100MA load, and ensure all terminals are clear of foreign matter.

### Replacing the battery- Don't throw the unit out!!

The SL-70 lanterns are the only compact marine lantern with a double sealed battery compartment. This provides the user with the ability to change the battery after years of operation.

1. Remove the marked flash adjustment bung from the base of the lantern and set internal toggle switch to 'OFF'.
2. Unscrew small screws to remove battery plate.
3. Remove battery from SL-70 case and unscrew positive and negative leads.
4. Discard old battery in a safe manner.
5. Reattach positive and negative leads to new battery and then place back into case.
6. Reattach battery plate and switch lantern 'ON' via internal switch. Close the bung.
7. To test place dark cover (towel or jacket) on top of lantern to activate sensor, lantern will come on.

***Care must be taken to observe the polarity of the battery before the leads are re-connected, and ensure the replacement battery is correctly fitted. Always discard old batteries in a safe manner.***

### Long Term Storage Instructions

If the SL-70 is to be placed in storage for an extended period, being more than 5 months, please follow the below steps.

1. The 3.6V NiMH Battery must be stored in a fully charged condition.
2. Remove the Flash Adjustment plug and turn the ON/OFF switch to the OFF position.
3. Remove the battery cover and disconnect the Positive (+) Terminal.
4. Fold the Terminal away from the Negative Battery Terminal.
5. Replace the Battery Cover
6. Replace the Flash Adjustment Plug.

All batteries will discharge over time and the rate of discharge is dependent on temperature. If the lantern is being stored in temperatures greater than 40°C the battery will discharge faster.

Please check battery every 3-6 months and recharge if necessary.

### Recharging the Battery

1. Remove the Battery Cover and connect the Positive Terminal.
2. Remove the Flash Adjustment Plug and turn the ON/OFF switch to the ON position.
3. Reconnect the Light Head and place unit in the sun for 2-4 days

Or

Reconnect Light Head and place in front of a halogen lamp for 2-3 days. (Do not place the halogen light too close to the solar panel or the panel may be overheated)

Check the battery voltage regularly to make sure the unit is charging correctly.

After the battery has been recharged, switch the lantern OFF.

## Trouble Shooting

Problem	Remedy
Lantern will not activate.	<ul style="list-style-type: none"> <li>• Ensure internal toggle switch is set to the 'ON position.</li> <li>• Ensure lantern is in darkness.</li> <li>• Wait at least 60 seconds for the program to initialise in darkness.</li> <li>• Ensure switch setting is on a valid code (See '<i>Flash Codes</i>' section of this manual).</li> <li>• Ensure battery terminals are properly connected.</li> <li>• Ensure battery voltage is above 3.4volts.</li> </ul>
Timing codes will not change.	<ul style="list-style-type: none"> <li>• Turn rotary switches several times to ensure contacts are clear.</li> </ul>
Lantern will not operate for the entire night.	<ul style="list-style-type: none"> <li>• Expose lantern to direct sunlight and monitor operation for several days. Sealite products typically require 1.5 hours of direct sunlight per day to retain full autonomy. From a discharged state, the lantern may require several days of operational conditions to 'cycle' up to full autonomy.</li> <li>• Reducing the light output intensity or duty cycle (flash code) will reduce current draw on the battery.</li> <li>• Ensure solar module is clean and not covered by shading during the day.</li> </ul>
Lanterns are constantly on during the day.	<ul style="list-style-type: none"> <li>• Ensure the flash code is not set to F F. This flash code is for testing purposes only and will be steady on for 24 hours a day.</li> </ul>





## Notes



## Sealite LED Light Warranty V2.2

### Activating the Warranty

Upon purchase, the Sealite Pty Ltd warranty must be activated for recognition of future claims. To do this you need to register on-line. Please complete the Online Registration Form at:

www.sealite.com

**Sealite Pty Ltd will repair or replace your LED light in the event of electronic failure for a period of up to three years from the date of purchase, as per the terms & conditions below.**

**Sealite Pty Ltd will repair or replace any ancillary or accessory products in the event of failure for a period of up to one year from the date of purchase, as per the terms & conditions below.**

**The unit(s) must be returned to Sealite freight prepaid.**

### Warranty Terms

1. Sealite Pty Ltd warrants that any Sealite marine products fitted with telemetry equipment including but not limited to AIS, GSM, GPS or RF ("Telemetry Products") will be free from defective materials and workmanship under normal and intended use, subject to the conditions hereinafter set forth, for a period of twelve (12) months from the date of purchase by the original purchaser.
2. Sealite Pty Ltd warrants that any BargeSafe™ Series of LED barge light products ("BargeSafe™ Products") will be free from defective materials and workmanship under normal and intended use, subject to the conditions hereinafter set forth, for a period of twelve (12) months from the date of purchase by the original purchaser.
3. Sealite Pty Ltd warrants that any LED area lighting products ("Area Lighting Products") but not including sign lighting products will be free from defective materials and workmanship under normal and intended use, subject to the conditions hereinafter set forth, for a period of twelve (12) months from the date of purchase by the original purchaser.
4. Sealite Pty Ltd warrants that any ancillary products and accessories, not mentioned in other clauses in this section, will be free from defective materials and workmanship under normal and intended use, subject to the conditions hereinafter set forth, for a period of twelve (12) months from the date of purchase by the original purchaser.
5. Sealite Pty Ltd warrants that any LED sign lighting products ("Sign Lighting Products") will be free from defective materials and workmanship under normal and intended use, subject to the conditions hereinafter set forth, for a period of three (3) years from the date of purchase by the original purchaser.
6. Sealite Pty Ltd warrants that any Sealite marine lighting products other than the Telemetry Products, BargeSafe™ Products, and Area Lighting Products ("Sealite Products") will be free from defective materials and workmanship under normal and intended use, subject to the conditions hereinafter set forth, for a period of three (3) years from the date of purchase by the original purchaser.
7. Sealite Pty Ltd will repair or replace, at Sealite's sole discretion, any Telemetry Products, BargeSafe™ Products, Area Lighting Products or Sealite Products found to be defective in material and workmanship in the relevant warranty period so long as the Warranty Conditions (set out below) are satisfied.
8. If any Telemetry Products, BargeSafe™ Products, Area Lighting Products or Sealite Products are fitted with a rechargeable battery, Sealite Pty Ltd warrants the battery will be free from defect for a period of one (1) year when used within original manufacturer's specifications and instructions.
9. Buoy products are covered by a separate 'Sealite Buoy Warranty'.

### Warranty Conditions

This Warranty is subject to the following conditions and limitations;

1. The warranty is applicable to lanterns manufactured from 1/1/2009.
2. The warranty is void and inapplicable if:
  - a. the product has been used or handled other than in accordance with the instructions in the owner's manual and any other information or instructions provided to the customer by Sealite;
  - b. the product has been deliberately abused, or misused, damaged by accident or neglect or in being transported; or
  - c. the defect is due to the product being repaired or tampered with by anyone other than Sealite or



authorised Sealite repair personnel.

3. The customer must give Sealite Pty Ltd notice of any defect with the product within 30 days of the customer becoming aware of the defect.
4. Rechargeable batteries have a limited number of charge cycles and may eventually need to be replaced. Typical battery replacement period is 3-4 years. Long term exposure to high temperatures will shorten the battery life. Batteries used or stored in a manner inconsistent with the manufacturer's specifications and instructions shall not be covered by this warranty.
5. No modifications to the original specifications determined by Sealite shall be made without written approval of Sealite Pty Ltd.
6. Sealite lights can be fitted with 3rd party power supplies and accessories but are covered by the 3rd party warranty terms and conditions.
7. The product must be packed and returned to Sealite Pty Ltd by the customer at his or her sole expense. Sealite Pty Ltd will pay return freight of its choice. A returned product must be accompanied by a written description of the defect and a photocopy of the original purchase receipt. This receipt must clearly list model and serial number, the date of purchase, the name and address of the purchaser and authorised dealer and the price paid by the purchaser. On receipt of the product, Sealite Pty Ltd will assess the product and advise the customer as to whether the claimed defect is covered by this warranty.
8. Sealite Pty Ltd reserves the right to modify the design of any product without obligation to purchasers of previously manufactured products and to change the prices or specifications of any product without notice or obligation to any person.
9. Input voltage shall not exceed those recommended for the product.
10. Warranty does not cover damage caused by the incorrect replacement of battery in solar lantern models.
11. This warranty does not cover any damage or defect caused to any product as a result of water flooding or any other acts of nature.
12. There are no representations or warranties of any kind by Sealite or any other person who is an agent, employee, or other representative or affiliate of Sealite, express or implied, with respect to condition of performance of any product, their merchantability, or fitness for a particular purpose, or with respect to any other matter relating to any products.

### **Limitation of Liability**

To the extent permitted by acts and regulations applicable in the country of manufacture, the liability of Sealite Pty Ltd under this Warranty will be, at the option of Sealite Pty Ltd, limited to either the replacement or repair of any defective product covered by this Warranty. Sealite will not be liable to Buyer for consequential damages resulting from any defect or deficiencies.

### **Limited to Original Purchaser**

This Warranty is for the sole benefit of the original purchaser of the covered product and shall not extend to any subsequent purchaser of the product.

### **Miscellaneous**

Apart from the specific warranties provided under this warranty, all other express or implied warranties relating to the above product is hereby excluded to the fullest extent allowable under law. The warranty does not extend to any lost profits, loss of good will or any indirect, incidental or consequential costs or damages or losses incurred by the purchaser as a result of any defect with the covered product.

### **Warrantor**

Sealite Pty Ltd has authorised distribution in many countries of the world. In each country, the authorised importing distributor has accepted the responsibility for warranty of products sold by distributor. Warranty service should normally be obtained from the importing distributor from whom you purchased your product. In the event of service required beyond the capability of the importer, Sealite Pty Ltd will fulfil the conditions of the warranty. Such product must be returned at the owner's expense to the Sealite Pty Ltd factory, together with a photocopy of the bill of sale for that product, a detailed description of the problem, and any information necessary for return shipment.

Information in this manual is subject to change without notice and does not represent a commitment on the part of the vendor.  
Sealite products are subject to certain Australian and worldwide patent applications.

**Other Sealite Products Available**



**Marine Lanterns  
(1-19NM)**



**Monitoring  
& Control Systems**



**Bridge & Barge Lights**



**Marine Buoys  
(up to 3mt in diameter)**

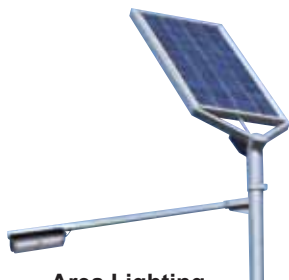

**Area Lighting**



**Mooring Systems  
& Accessories**



**Sealite**  
www.sealite.com

**Head Office**  
Sealite Pty Ltd  
11 Industrial Drive  
Somerville, Vic 3912  
Australia  
Tel: +61 3 5977 6128  
Fax: +61 3 5977 6124  
Email: info@sealite.com  
Internet: www.sealite.com

