



INSTALLATION, OPERATION AND SERVICE MANUAL SALAMANDER S86

WARNINGS



IMPROPER INSTALLATION, ADJUSTMENT, ALTERATION, SERVICE OR MAINTENANCE CAN CAUSE INJURY OR DEATH. THE INSTRUCTION MANUAL MUST BE READ CAREFULLY BEFORE INSTALLING, OPERATING OR SERVICING THIS EQUIPMENT



TO BE INSTALLED ONLY BY AN AUTHORISED PERSON IN ACCORDANCE WITH AS 5601, LOCAL AUTHORITY, GAS, ELECTRICITY, ANY APPLICABLE STATUTORY REGULATIONS AND MANUFACTURER REQUIREMENTS.



THIS EQUIPMENT IS DESIGNED FOR COMMERCIAL CATERING PURPOSES AND WILL GENERATE SIGNIFICANT HEAT. HOT SURFACES WILL CAUSE BURNS. A HAZARD AND RISK ASSESSMENT MUST BE UNDERTAKEN BY OWNERS AND ALL OPERATORS MADE AWARE OF THESE.



DO NOT STORE OR USE FLAMMABLE LIQUIDS NEAR THIS APPLIANCE.



DO NOT SPRAY AEROSOLS NEAR THIS APPLIANCE WHILE IT IS IN OPERATION.



INSTALLATION CLEARANCES AS SPECIFIED MUST BE OBSERVED.



IF YOU SMELL GAS, TURN THE UNIT OFF AND THE MAIN GAS SUPPLY VALVE TO THE UNIT. CONTACT YOUR GAS SUPPLIER OR AN AUTHORISED PERSON.



BEFORE TURNING ON THE MAIN GAS SUPPLY, CHECK THE UNIT TO BE CERTAIN THAT ALL THE VALVES ARE IN THE “OFF” POSITION.

PLEASE KEEP THIS MANUAL FOR FUTURE REFERENCE AND REFERENCE BY ALL OPERATORS.

CONGRATULATIONS

Comcater thanks you for choosing this product and welcomes you to the ever-growing Comcater customer circle. This product has been specifically designed by Comcater to meet a wide range of applications and represents the best quality and highest value equipment.

Please read the instruction manual carefully to ensure the safe and reliable operation and performance of your equipment.

Should you ever require service, you will be supported by Comcater's trained and qualified service network – the largest available.

Comcater assures you of every support and wishes you every business success.

Michael Wood
Managing Director
Comcater

TABLE OF CONTENTS

INTRODUCTION	5
GENERAL.....	5
WARRANTY	5
GENERAL INFORMATION	6
INSPECTION.....	6
OPERATOR MANUAL	6
INSTALLATION.....	6
GAS CONNECTION	6
GAS PRESSURE	6
COMMISSIONING.....	6
SPECIFICATIONS	7
INSTALLATION.....	7
GAS SUPPLY PRESSURE.....	9
NOMINAL GAS CONSUMPTION	9
TEST POINT PRESSURE	9
VENTILATION AND AIR SUPPLY.....	9
GENERAL SPECIFICATIONS	10
OPERATING INSTRUCTIONS	11
LIGHTING INSTRUCTIONS.....	11
SALAMANDER BURNERS.....	12
SALAMANDER BURNER IGNITION	12
OPERATOR MAINTENANCE	15
CLEANING STAINLESS STEEL.....	16
SERVICE	17
RECOMMENDED SERVICE	17
SERVICE INFORMATION	17
BURNER ADJUSTMENTS	18
CONVERSION INSTRUCTIONS.....	19
SPARE PARTS	20
TROUBLE SHOOTING	21
ALL BURNERS.....	21
SALAMANDER – MAJOR PARTS IDENTIFICATION	22
SALAMANDER – EXPLODED VIEWS AND	
BILL OF MATERIALS	25
DRAWINGS	27

INTRODUCTION

GENERAL

This equipment is designed for commercial catering purposes and incorporates a wide range of design features to benefit the customer. This versatility will satisfy a wide range of customer needs.

WARRANTY

This product is warranted for 12 months parts and labour and is subject to the correct installation, operation, maintenance and care of the equipment.

Warranty does not extend to:

- Damages caused in shipment.
- Damage as a result of incorrect installation.
- Damage as a result of incorrect operation.
- Damages caused by unauthorised service and use of non-original parts.
- Gas supply issues to the equipment.
- Failure resulting from improper maintenance.
- Failure as a result of tampering with, removal of, or changing any preset control or safety device.
- Service 'After hours'.
- Conditions as defined in Comcater terms and condition of sale.

For all warranty work, authorized service and genuine and authorized spare parts, please contact Comcater Service 03 8369 4600.

Please ensure you quote the Model and Serial Number of the unit. The Model and Serial Number of the unit is recorded on the sales invoice. Alternatively, the information is recorded on the front of the unit and on the data plate located behind the front panel.

GENERAL INFORMATION

INSPECTION

Please inspect the unit on receipt. If the unit is damaged, contact the carrier immediately and file a damage claim with them. Save all packing materials when filing a claim. Freight damage claims are the responsibility of the purchaser and are not covered under warranty.

OPERATOR MANUAL

This manual contains important information for your safety and the installation, operation, maintenance and service of this equipment. Please read the manual carefully and ensure all operators of the equipment are aware of the contents and safety requirements.

Warning: You must assess all hazards and risks associated with the operation of the equipment in your environment and advise all operators of these.

INSTALLATION

This equipment must be installed by an authorized person in accordance with AS 5601, local authority, gas, electricity, any applicable statutory regulations and manufacturer requirements.

GAS CONNECTION

The appliance must be connected by an authorized person to the gas type specified on the unit. The gas type is shown adjacent to the rear gas connection point on the back panel and on the data plate. Connect to and use only the correct type of gas.

GAS PRESSURE

The authorized person installing this equipment must ensure that the gas operating pressure is the same as shown on the rating plate, the test point pressure is correct (refer page 9) and that there is sufficient gas volume.

COMMISSIONING

The authorized person installing this equipment must commission the equipment in accordance with AS 5601 - gas leakage, operational checking, adjustments and instructing the owner on use of the equipment are prescribed requirements.

SPECIFICATIONS

INSTALLATION



THIS EQUIPMENT MUST BE INSTALLED BY AN AUTHORIZED PERSON IN ACCORDANCE WITH AS 5601, LOCAL AUTHORITY, GAS, ELECTRICITY, ANY APPLICABLE STATUTORY REGULATIONS AND MANUFACTURER REQUIREMENTS.

NOTE: INSTALLATION IS THE RESPONSIBILITY OF THE OWNER

Gas Inlet Connection: ½" BSP Female.

Gas Connection Point: The gas connection point is located at the rear of the unit (300 mm from the right hand side and 45mm above the base of the unit)
Details are shown in the drawing at the rear of this manual.

Gas Connection: The appliance must be connected by an authorized person to the gas type specified on the unit. The gas type is shown adjacent to the gas connection point and on the data plate. **Connect to and use only the correct type of gas.**

The authorized person installing this equipment must comply with AS 5601 requirements. Prescribed requirements include, commission the equipment, gas leakage testing, operational checking and adjustments.

All units are tested and adjusted at the factory; however, burners and pilots must be checked at the installed location and adjusted if necessary.

Data Plate: The data plate is located behind the front panel.

Installation: The Salamander is provided with two mounting brackets. The brackets may be fitted in two ways as follows:

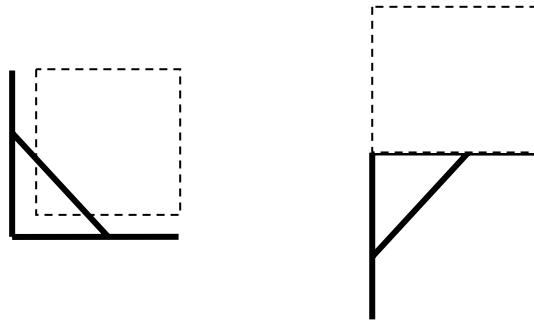

Select a suitable location and fix the mounting brackets in position (Refer 'Installation Clearances' below). The brackets must be securely mounted.

Mount the Salamander to the brackets by inserting the four M10 mounting bolts (supplied) from the underside of the bracket into the Salamander.

Warning: The Salamander mounting bolts must be inserted and secured.

Warning: The Salamander should never be installed and operated as a counter top unit.

Installation Clearances: The **MINIMUM** clearances from combustible surfaces are:

Sides: 300mm (Note: the sides of the Salamander are removable and adequate clearance must be provided for safe handling large products.

Rear: 100mm

Adequate clearance must also be provided for service.

MINIMUM GAS SUPPLY INLET PRESSURE

Gas Type	Gas Pressure
Natural Gas	1.13 kPa
LP Gas	2.75 kPa

NOMINAL GAS CONSUMPTION

BURNER (EACH)	NATURAL GAS			PROPANE GAS		
	ORIFICE (mm)	MJ/h	TEST POINT PRESSURE	ORIFICE (mm)	MJ/h	TEST POINT PRESSURE
SALAMANDER	1.70mm	14	1.0 kPa	1.00mm	13	2.60 kPa
TOTAL		28			26	

Note: Pressure test point is located on the gas manifold (refer also 'Test Point Pressure' below).

Turndown Setting

Natural Gas 5 turns out from fully in

Propane Gas 3 turns out from fully in

TEST POINT PRESSURE

The gas pressure test point is located on the gas manifold and is accessed by removing the gas valve control knobs, piezzo igniter leads and the front panel. The test point pressure is shown in the Nominal Gas Consumption Table above and is **set with the two burners operating at maximum setting**.

VENTILATION AND AIR SUPPLY

All gas burners and pilots require sufficient air to operate. For optimum performance and for your safety, it is ESSENTIAL that the equipment, in the installed position, has the proper air and ventilation and the correct exhaust/canopy and air balance. The correct installation and compliance with all regulatory and other requirements is the responsibility of the purchaser/owner.

Please note that a strong exhaust canopy will create a vacuum if there is insufficient replacement air. The amount of air exhausted must be replaced by an equal amount of air.

Airflow to the appliance must not be blocked or restricted (e.g. large objects should not be placed in front of the appliance).

GENERAL SPECIFICATIONS

OVERALL DIMENSIONS AND WEIGHT

MODEL	DEPTH (mm)	WIDTH (mm)	HEIGHT (mm)	WEIGHT (Kg)
SALAMANDER CCE S86				
Assembled	515	860	440	63
Shipping	635	980	560	81

Detailed dimensional specifications are shown at the rear of this manual.

OPERATING INSTRUCTIONS

LIGHTING INSTRUCTIONS



DO NOT OPERATE THE UNIT UNLESS IT HAS BEEN INSTALLED AND COMMISSIONED BY AN AUTHORIZED PERSON.



BEFORE TURNING ON THE MAIN GAS SUPPLY, CHECK AND ENSURE THAT ALL THE VALVES ARE IN THE “OFF” POSITION.



THIS EQUIPMENT IS DESIGNED FOR COMMERCIAL CATERING PURPOSES AND WILL GENERATE SIGNIFICANT HEAT. HOT SURFACES WILL CAUSE BURNS. A HAZARD AND RISK ASSESSMENT MUST BE UNDERTAKEN BY OWNERS AND ALL OPERATORS MADE AWARE OF THESE.



THE TOP OF THE SALAMANDER HAS FLUE OUTLETS AND IS VERY HOT – THE FLUE OUTLETS MUST NEVER BE COVERED OR RESTRICTED IN ANY WAY AND STAFF MUST BE INSTRUCTED NOT TO TOUCH THE TOP SURFACE.

NOTE: For your safety, all burners are controlled by a flame failure sensing device. If the device does not sense a flame, gas supply to the burner will be cut.

SALAMANDER BURNERS

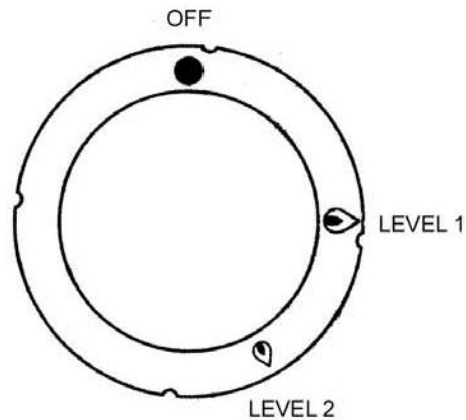

Salamander Burner Control

WARNING: Ensure there are no objects placed on top of the unit and that there are no restrictions to the flue passages.

NOTE: Ensure the gas supply to the equipment is turned ON

SALAMANDER BURNER IGNITION

Starting from the OFF ● position, turn the control knob to the LEVEL 1 position.

Fully depress the control knob and then press the piezzo igniter to ignite the burner – repeat until the burner ignites. Keep the knob fully depressed for 15 seconds after the burner lights. When the automatic valve senses that the BURNER is alight, the gas flow to the burner will continue when the knob is released. The equipment may then be operated between LEVEL 1 position (highest heat) and LEVEL 2 (lowest heat).

NOTE: When the equipment is cold, the gas properties are such that it is likely to be easier to light the burner (at the front or the side) with a gas torch rather than the piezzo igniter as per the above process.

WARNING: NEVER PLACE YOUR HAND UNDER THE BURNER.

Shut Down

Turn the control knob to the OFF ● position.

NOTE: If the burner flame were accidentally extinguished, the flame failure safety device would operate and cut the gas flow to the main burner. It would then be necessary to re-light the burners by following the above procedure.

Cooking Shelf

The cooking shelf holds the cooking tray and grease drawer and slides in and out for ease of loading and removing product. A lock is provided to prevent accidental complete removal of the cooking shelf. To completely remove the cooking shelf, lift the handle upwards and carefully remove.

Warning: Hot surfaces – use appropriate safe handling techniques and protective clothing.

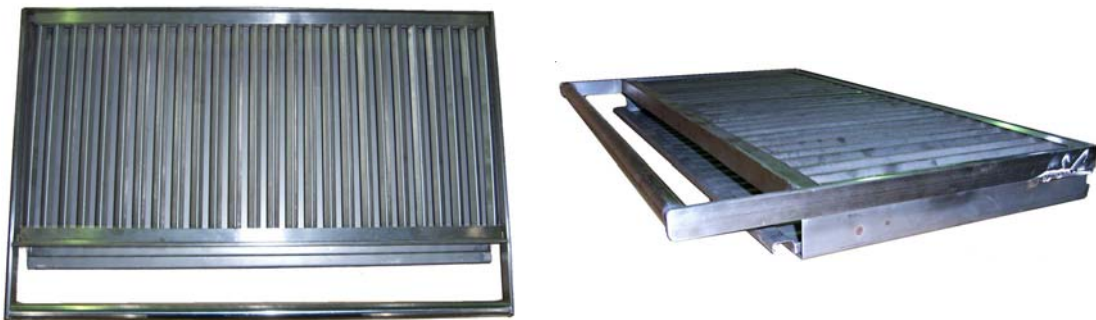

Cooking Shelf Assembly

Cooking Shelf Height

The cooking shelf height is adjustable. To adjust the height, lift the height adjustment control arm and move laterally until the desired height is reached and then lower the control arm into the desired slot. In the highest position, the cooking tray is 45mm from the burner. In the lowest position, the cooking tray is 125mm from the burner.

Warning: Ensure the height adjustment control arm is always locked in a position.

Warning: Hot surfaces – use appropriate safe handling techniques and protective clothing.

End Covers/Sides

The end covers/sides of the Salamander are removable – either or both may be removed as required. The covers are removed by pulling outwards.

Warning: Hot surfaces – use appropriate safe handling techniques and protective clothing.

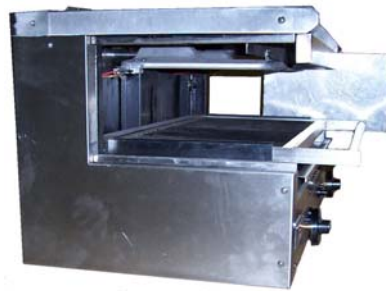

Cooking

Many factors will determine the best cooking height for your product. As a general guide:

- If your product is burning on top and the internal temperature is low, the cooking tray may be too close to the burner and should be lowered.
- If the product is not browning or cooking fast enough, raise the cooking tray.

Warning: Hot surfaces – use appropriate safe handling techniques and protective clothing.

OPERATOR MAINTENANCE



USE ONLY SUITABLE CHEMICALS AND OBSERVE ALL MANUFACTURER SAFETY REQUIREMENTS FOR SAFE HANDLING AND USE.

Note: The equipment must be kept clean to ensure safe and reliable operation and performance.

Warning: Empty the grease drawer as necessary and clean. Excessive deposits in the grease drawer may cause flare-ups.

Warning: Hot surfaces – use appropriate safe handling techniques and protective clothing.

The following procedures are recommended – the amount of cleaning will depend on the equipment usage and the products being cooked.

After each use: Ensure the cooking tray and grease draw are clean. Excessive deposits in the grease drawer may cause flare-ups (Refer 'Cleaning Stainless Steel' below).

Daily: The cooking shelf and grease tray should be removed and cleaned with hot water and detergent. Wipe and clean all exterior surfaces (Refer 'Cleaning Stainless Steel' below).

Weekly: Inspect all surfaces of the cooking chamber, including burners, and clean as necessary. More frequent cleaning may be necessary based on equipment usage.

Burners: The burners may be removed and cleaned as necessary by undoing the burner retaining screw, removing the piezzo ignition lead, releasing the thermocouple from the ignition block (held by spring force), lifting up the burner and pulling forward – after cleaning, ensure the burner is dry and replaced in reverse order in the correct position.

Warning: If your burners require cleaning and you are not confident in performing this task, please call for service.

Lifting Mechanism: It may be necessary to lubricate the lifting mechanism on occasions. If required, use industry approved, heat resistant, food safe grease on the chain and sprockets. These are accessed by removing the protective cover.

CLEANING STAINLESS STEEL

Regularly wipe surfaces with hot water and detergent (use non-abrasive cleaning aids as necessary). Rinse the washed area with a wet sponge and clean water and wipe the area dry to prevent streaking. Follow this process and wash a small area at a time to prevent chemical residue and streaking.

Stainless steel may discolour if overheated. These stains can usually be removed using an appropriate powder/paste. To scrape off heavy deposits of grease and oil, use only wood or plastic tools as necessary.

Note: Never use steel wool to clean stainless steel.

Note: Damage may occur if chemicals not suitable for stainless steel are used.

Note: Use non-abrasive cleaning aids (Brushes/Pads).

SERVICE



FOR YOUR SAFETY, ALL SERVICE WORK MUST BE CARRIED OUT BY AN AUTHORISED PERSON AND USE ONLY ORIGINAL SUPPLIED AND SPECIFIED PARTS.



TEST ALL FITTINGS, PIPES AND PIPE CONNECTIONS FOR LEAKS IN ACCORDANCE WITH APPROVED GAS LEAK TEST PROCESSES AND METHODS. DO NOT USE A FLAME.

Note: When checking gas test point pressure, ensure that all other equipment on the same line is turned 'ON' and operating.

RECOMMENDED SERVICE

It is recommended that an authorized person service your appliance every 12 months. This period is for guidance purpose only and may vary based on usage of the equipment and operator care. Prescribed service tasks include;

- Functional test of all components and clean, lubricate and adjust as necessary.
- Inspect and clean all gas valves and lubricate with an industry approved lubricant.
- Inspect all gas piping.
- Check and adjust specified gas pressures.
- Leak test.
- Full operational, performance and safety test.

SERVICE INFORMATION

- To access gas valves, remove control knobs and the front panel.
- To remove a gas valve, disconnect the gas valve at the manifold tee spigot connection and remove the valve.
- To access thermocouples, release the thermocouple from the ignition block (spring clip) or remove the top of the unit.
- To access burners, remove the top panel, undo the retaining screw, remove the piezzo ignition lead, release the thermocouple from the ignition block (held by spring force), lift up the burner and pull forward – re-assemble in reverse order.

BURNER ADJUSTMENTS

Leak Test

- Ensure that all valves are in the OFF position.
- Turn on the main gas supply valve.
- Light the burners.
- Leak test all valves and fittings using approved methods.
- Correct any leaks as required and re-check.
- Shut off all valves and set controls to the “OFF” position.

Test Point Pressure

The test point is located on the gas manifold. The gas manifold and pressure test point is accessed by removing the gas valve control knobs and the front panel. The test point pressure is shown in the Nominal Gas Consumption Table and is **set with the two burners operating at maximum setting.**

Burner Adjustment

The burner orifices are fixed as specified and cannot be adjusted. The specified gas rate will be achieved if the gas supply pressure and test point pressure is correct and all gas components are clean and free of blockages.

The turndown (low flame) setting can be adjusted by adjusting the screw on the gas valve.

A distinct blue flame over the entire port area of the burner will be achieved at full rate when the air supply is correct.

If the flame is yellow and wavy, the cause needs to be established.

WARNING: If you are not competent in performing any service task or require assistance, please contact Comcater Service 03 8369 4600.

CONVERSION INSTRUCTIONS



TO BE COMPLETED BY AN AUTHORISED PERSON



ENSURE GAS IS ISOLATED WHILST PERFORMING CONVERSION WORK. PERFORM A LEAK TEST BEFORE IGNITING AND MAKING BURNER AND PILOT ADJUSTMENTS.

TO PROPANE GAS

Regulator Change regulator to PROPANE gas configuration and adjust as necessary.

Burner Injectors Access and change the injectors to PROPANE Gas injectors (**refer Nominal Gas Consumption Table**).

LEAK TEST IN ACCORDANCE WITH APPROVED METHODS

Ignite burners and adjust.

AMEND DATA PLATE AND APPLY 'PROPANE' GAS LABEL

TO NATURAL GAS (NG)

Regulator Change regulator to NG gas configuration and adjust as necessary.

Burner Injectors Access and change the injectors to NG Injectors (**refer Nominal Gas Consumption Table**).

LEAK TEST IN ACCORDANCE WITH APPROVED METHODS

Ignite burners and adjust.

AMEND DATA PLATE AND APPLY 'NATURAL GAS' LABEL.

SPARE PARTS

A list of major spare part items is shown at the end of this manual.

These parts and all other parts used in the Comcater Salamander are available from Comcater.

Warning: Use only genuine spare parts.

Warning: Use of non-authorized parts voids warranty and equipment approval.

TROUBLE SHOOTING



**ALL SERVICE WORK TO BE COMPLETED BY AN
AUTHORISED PERSON.**









ALL BURNERS

CONDITION



CHECK

Yellow burner flame.	Primary air Check air supply and ventilation
Flame lifting off burner ports.	Primary air Check air supply and ventilation
'Popping' after turning off.	Primary air Air shutter
Burner flame too large.	Gas pressure
Piezzo will not spark.	Igniter lead, igniter and electrode
Flame burns back to orifice.	Primary air

MAJOR PARTS IDENTIFICATION

IDENTIFICATION	PART NUMBER	ITEM NAME
	CCE KB-BTW20	Burner Infra-Red Large (Salamander)
	CCE KB-F60N	Flame Failure Gas Valve F60N with 3/8" Nut and Olive (Salamander)
	CCE KB-99301/270	Knob Black – Suit F60P/F60N (Range/Barbeque/Salamander)
	CCE KB-99301/DG	Decal Knob – Grill (Range/Barbeque/Salamander)
	CCE KB-99301/E	Escutcheon – F60N (Salamander)
	CCE KB-C7931	Ignition Block to Suit CCE KB-BTW20 (Salamander)
	CCE KG-200090	Thermocouple 900XM9XUnif/Sleeve
	CCE KB-301170	Injector 1/8" BSP Salamander Burners (NG 1.70mm)
	CCE KB-301100	Injector 1/8" BSP Salamander Burners (LPG 1.00mm)

	CCE KB-23700	Injector Holder
	CCE KG-073964	Piezzo Igniter and Nut – Red Button
	CCE KG-HT1000	Lead Ignition H/T 1000 mm (Salamander)
	CCE Q01011D	Cooking Tray
	CCE Q01011E	Grease Drawer
	CCE Q01011O	Salamander Mounting Bracket (Universal L/R)
	CCE KB-WMT	Manifold Tee 1/4” BSP Male

	<p>CCE KB-WMT/TP</p>	<p>Manifold Tee ¼" BSP Male Complete With Pressure Test Point</p>
	<p>CCE KB-AT952-15</p>	<p>3/8" (10mm) Aluminium Tube</p>
	<p>CCE KB-RV47LM CCE</p>	<p>MAXITROL GAS REGULATOR ½" BSP NG MAXITROL CONVERSION KIT LPG</p>

Source File: PARTSIDENTIFICATION SALAMANDER 13 Sep 07

COMCATER SALAMANDER S86
EXPLODED VIEW

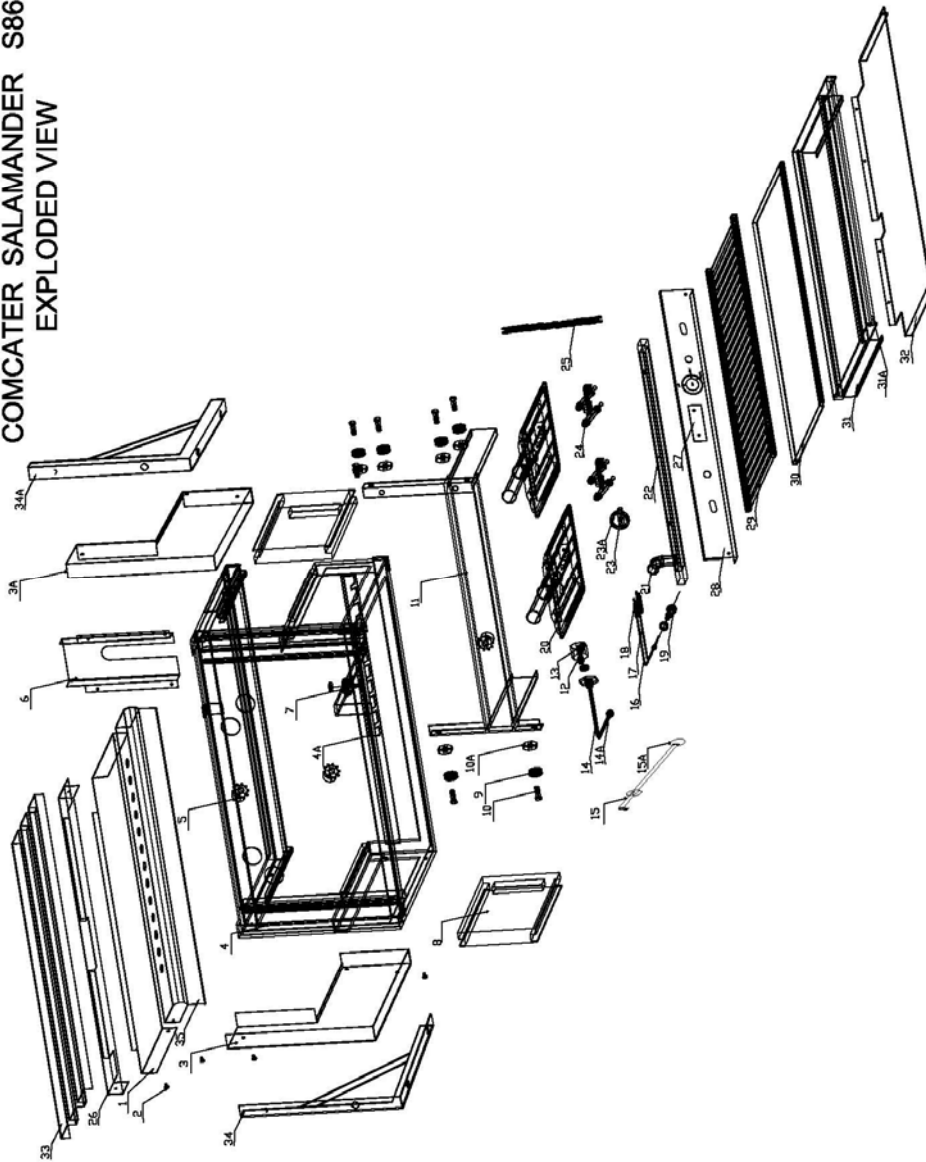

File source:CCE-S86-BZ-01(291006)

**COMCATER PARTS IDENTIFICATION - SALAMANDER SECTION -
BILL OF MATERIAL**

MODEL: S86

Item	Part No.	Description	QTY
1	CCE Q01011A	TOP PANEL	1
2	CCE Q01019	SCREW	15
3	CCE Q01011B	LEFT HAND PANEL	1
3A	CCE Q01011H	RIGHT HAND PANEL	1
4	CCE Q30014	FRAME	1
4A	CCE Q01011I	HEIGHT ADJUSTMENT LATCH	1
5	CCE Q27020	SPROCKET	3
6	CCE Q01011G	COVER PLATE	1
7	CCE Q01012A	HEIGHT ADJUSTMENT LEVER BEARING	1
8	CCE Q01011C	LEFT/RIGHT HAND REMOVABLE PANEL	One/each
9	CCE Q01012B	BEARING	6
10	CCE C29014	SCREW M10 X 30	6
10A	CCE C28018	NUT M10	6
11	CCE Q01012C	HEIGHT ADJUSTMENT FRAME	1
12	CCE KB-301XXX	INJECTOR 1/8" BSP	2
13	CCE KB-23700	INJECTOR HOLDER	2
14	CCE Q21001A	INJECTOR GAS SUPPLY TUBE	2
14A	CCE Q21001B	FLARE CONNECTOR	2
15	CCE Q21001C	HEIGHT ADJUSTMENT LEVER	1
15A	CCE Q21001D	KNOB	1
16	CCE KG-200090	THERMOCOUPLE 900XM8XUNIF/SLEEVE (SALAMANDER)	2
17	CCE KG - HT1000	LEAD IGNITION H/T 1000 mm (SALAMANDER)	2
18	CCE KB-C7931	IGNITION BLOCK SUIT CCE KB-BTW20 (SALAMANDER)	2
19	CCE KG-073964	PIEZZO IGNITER AND NUT - RED BUTTON	2
20	CCE KB-BTW20	BURNER INFRA-RED LARGE 18-20 M/JHR	2
21	CCE Q21001E	GAS MANIFOLD INLET	1
22	CCE Q21001G	MANIFOLD	1
23	CCE KB-99301/270	KNOB BLACK (SUIT F60P/F60N - RANGE/BARBEQUE/SALAMANDER)	2
23A	CCE KB-99301/DG	DECAL KNOB - GRILL (SUIT F60P/F60N - RANGE/BARBEQUE/SALAMANDER)	2
24	CCE KB-F60N	FLAME FAILURE GAS VALVE F60N (NO PILOT)(SALAMANDER)	2
25	CCE B06423	HEIGHT ADJUSTMENT CHAIN	1
26	CC Q01011K	REAR TOP PANEL	1
27	CCE E14064	COMCATER LOGO	1
28	CCE B13037	FRONT PANEL	1
29	CCE Q01011D	COOKING TRAY	1
30	CCE Q01011E	GREASE DRAWER	1
31	CCE Q01011J	COOKING DRAWER	1
31A	CCE Q01011F	HANDLE	1
32	CCE Q07005	BOTTOM PANEL	1
33	12201029	TOP PANEL HEAT PROTECTOR	1
34	S21001	MOUNTING BRACKET (UNIVERSAL)	2
35	12201017	TOP FRONT PANEL	1

File Source: Salamander Bill of Material (201006)

COMCATER SALAMANDER
S86

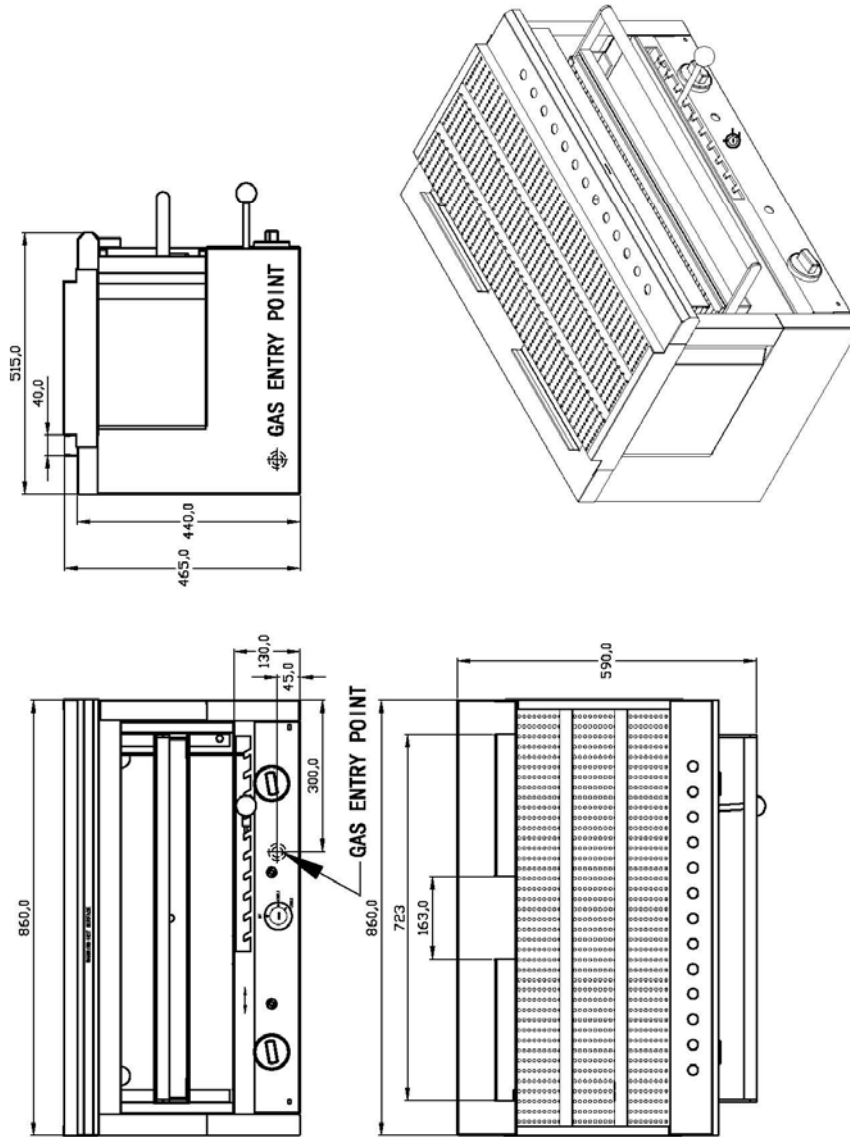

File source: COE S86-3D2 (291006)



Notes
