

High Definition Digital Set Top Box With USB Record

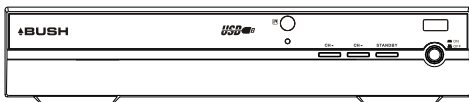

DFTA45R

The Gold Technical Support Line: 1902 215 259

(Charges will apply at \$2.95 per minute)

Safety Instructions

- Always read the safety instructions carefully
- Keep this Instruction Manual for future reference
- Keep this device away from humidity
- Lay this device on a reliable flat surface before setting it up
- Do not stand it on soft furnishings
- If any of the following situation arises, get the Set Top Box checked by a service technician:
 - ✗ It has been exposed to moisture
 - ✗ It has been dropped and damaged
 - ✗ It has obvious sign of breakage
 - ✗ It has not been working well or you cannot get it to work according to the Instruction Manual

Warning

- To prevent the risk of electric shock, do not open the cover or the back of the receiver.
- Do not block the ventilation holes of the device. Leave appropriate gap above and around it to allow for adequate ventilation.
- Do not place the device in an unventilated cabinet or on top of a unit which emits heat.

Copyright Statement

No part of this publication may be reproduced in any form by any means without the prior written permission. Other trademarks or brand names mentioned herein are trademarks or registered trademarks of their respective companies.

Disclaimer

Information in this document is subject to change without notice. The manufacturer does not make any representations or warranties (implied or otherwise) regarding the accuracy and completeness of this document and shall in no event be liable for any loss of profit or any commercial damage, including but not limited to special, incidental, consequential, or other damage.



This symbol indicates that this product incorporates double insulation between hazardous mains voltage and user accessible parts. When servicing use only identical replacement parts.

WARNING: To reduce the risk of fire or electric shock, do not expose this apparatus to rain or cords.

Introduction

Thank you for buying this Bush product, which is designed to give you many years of trouble-free service.

You may already be familiar with using a similar unit, but please take time to read these instructions. They are designed to familiarise you with the unit's many features and to ensure you get the very best from your purchase.

Safety is important

Your safety and the safety of others is important. Please therefore, ensure you read the "Safety Instructions" before you operate this unit.

Warranty

In the unlikely event that your product fails to work normally, please call the below Bush warranty number for support.

Australia

Bush Warranty: 1800 509 394

New Zealand

Bush Warranty: 0800 450 259

About the Set Top Box

This DVB-T TV Receiver allows you to access Free-to-Air Digital TV Channels and Radio Broadcasts on your TV set. Its digital reception covers VHF & UHF band. Digital TV eliminates noise and interference and offers high quality video and audio.

An easy to use on-screen installation guide is provided. In addition, a fully featured Remote Control is included that offers you access to every feature with a simple press of a button.

Main Features

- Compliant with Australian DVB-T Standards
- Full MPEG2 ISO/IEC 13818 Transport Stream Compliant Audio/Video Decoding
- Bandwidth of 7/8MHz Supported
- COFDM Demodulator
- Automatic/Manual Channel Search
- Channel Edit, Moving and Deletion
- Parental Lock Control
- EPG (Electronic Program Guide) and Teletext Function (where available)
- HDMI Output
- Multiple-Language OSD
- Supports Multi-Subtitle
- USB Input Supports JPEG Files, Music Files, Video Files for Recording and Software Upgrade
- Timeshift
- Tuner RF In/Loop Through
- Component / Video / Digital Audio via Coaxial Output
- Full Function Remote Control

Package Contents

Before installation, please check the items of the package.

The package should contain the following items:

~ DVB-T TV Receiver	x1 pc
~ Remote Control	x1 pc
~ AAA Battery for the Remote Control	x1 pair
~ Instruction Manual	x1 pc
~ Composite RCA Cable	x1 pc

Table of Contents

Front and Rear Panel	5
Remote Control	6-7
Connecting to a Television.....	8
Connecting to an Audio System.....	9
Connecting to a DVD Recorder or VCR.....	10
First Time Installation... ..	11
Basic Operations.....	11-19
Troubleshooting	20
Technical Specifications.....	21
Warranty.....	22

Front and Rear Panel

1. Front panel

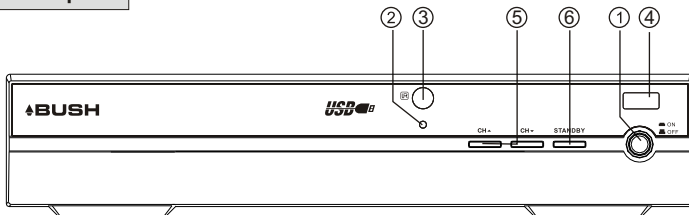

- ① **POWER BUTTON:** Press the Power Button to turn the unit on or off.
- ② **STANDBY INDICATOR:** Standby Indicator will be red if the Set Top Box is in Standby Mode or Green if the unit is on.
- ③ **REMOTE CONTROL SENSOR:** Receives the Signal from the Remote Control.
- ④ **USB:** USB Input Supports JPEG Files, Music Files, Video Files for Recording and Software Upgrade
- ⑤ **CHANNEL UP/DOWN:** Press the Channel Buttons to change the Channel.
- ⑥ **STANDBY:** Press the Standby Button to turn the unit to standby.

2. Rear panel

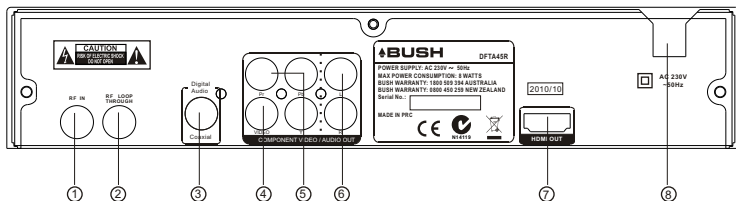

- ① **RF IN :** This socket connects to your external Aerial.
- ② **RF LOOP THROUGH:** This socket will bypass the RF signal to either your TV or another video system.
- ③ **COAXIAL:** This socket connects to a Coaxial cable on your surround sound system.
- ④ **VIDEO:** This socket outputs composite video signal.
- ⑤ **COMPONENT VIDEO OUT:** These sockets connect to your TV component input terminals.
- ⑥ **AUDIO L/R:** This socket outputs Analog Audio L/R signal.
- ⑦ **HDMI :** High definition audio and video output used to connect to a HDMI device
- ⑧ **MAINS CABLE:** This is used to connect to your main power supply.

Remote Control

1. **MUTE:** Press the Mute Button to switch off the Sound only. Press again to restore audio output
2. **INFO:** Press the INFO Button to display the current channel information
3. **TTX:** Press the TTX to enter the Teletext Menu
4. **SUBTITLE:** Press the Subtitle Button to select the subtitle setting
5. **EXIT:** Press the Exit button to exit the current Menu or return to the previous Menu
6. **OK:** Press the OK Button to confirm settings or menu selections. Also press to display the channel list
7. **RIGHT /LEFT:** Press the Navigate Buttons to move through the Menu options or to increase or decrease the volume
8. **TV/RADIO:** Press the TV/Radio Button to switch between from TV and Radio mode
9. **RECALL:** Press the Recall Button to go back to the previous channel you were watching.
10. **GOTO:** Press the GOTO Button to select the multimedia option
11. **PREV:** Press the Prev Button to skip to the previous track in multimedia mode or timeshift in DTV mode
12. **NEXT:** Press the Next Button to skip to the Next track in multimedia mode or timeshift in DTV mode
13. **REPEAT:** Press the Repeat Button to repeat play in multimedia mode
14. **STOP:** Press the Stop Button to stop play in Multimedia mode and return to normal viewing in timeshift mode.
15. **STANDBY:** Press the Standby Button to turn the unit to standby
16. **EPG:** (Electronic Program Guide) Press the EPG Button to enter the EPG menu
17. **AUDIO:** Press the Audio Button to change the audio settings
18. **UP /DOWN:** Press the Navigate Buttons to scroll through the channel list.
19. **MENU:** Press the Menu Button to enter the Main Menu
20. **FAVOURITE:** Press the Favourite Button to enter the Menu
21. **0-9 (Numeric Buttons):** Press the Numeric Buttons to enter a channel directly or setting information
22. **FWD:** Press the FWD Button to Fast Forward in Multimedia or timeshift mode
23. **REV:** Press the Rev Button to Rewind in Multimedia mode or timeshift mode
24. **PLAY:** Press the Play Button to begin or resume play in multimedia mode
25. **Pause:** Press the Pause Button to pause play in multimedia mode or to pause live TV.
26. **COLOUR BUTTONS:** Press the Colour Buttons to select different options in the menu, EPG and Teletext modes
27. **REC:** Press the Rec Button to record the program you are watching

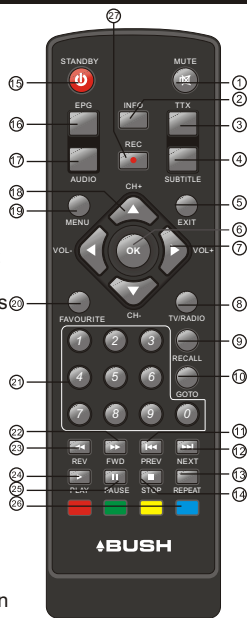

Installing the Batteries

Remove the battery cover from the Remote Control and put 2xAAA size batteries inside the compartment.

The diagram inside the Battery Compartment shows the correct way to install the batteries.

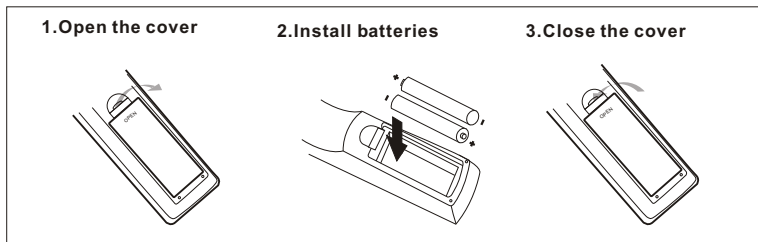

Using the Remote Control

To use the Remote Control, point it towards the front of the Digital Set Top Box. The Remote Control has a range of up to 7 metres from the Set Top Box at an angle of up to 60 degrees.

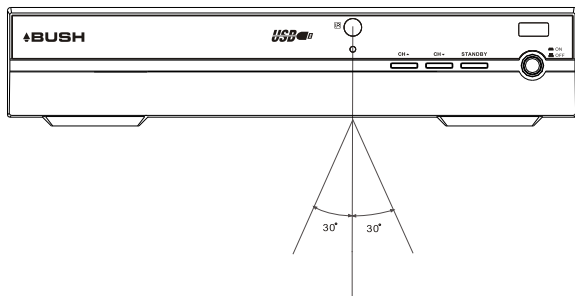

The Remote Control will not operate if its path is blocked.



Sunlight or very bright light will decrease the sensitivity of the Remote Control.

Connecting to a Television

For a basic connection from your Set Top Box to the television, use the Composite connection outlined below.

For a higher quality connection, use the Component Video connection outlined below combined with the Composite Audio Connection.

For the highest quality audio and video connection use a direct HDMI connection, as outlined below.

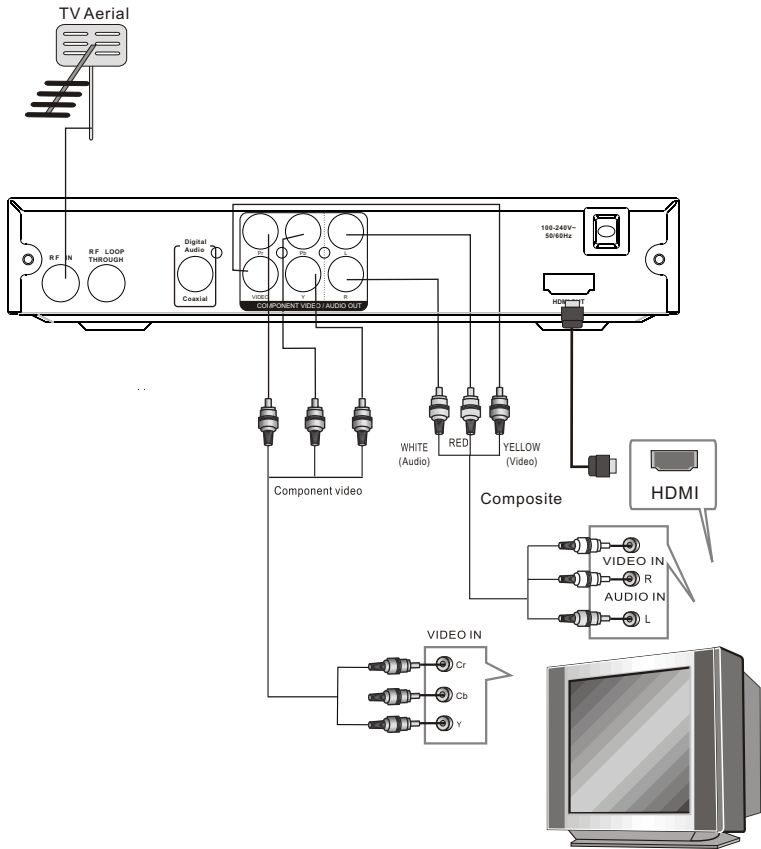

Connecting to an Audio System

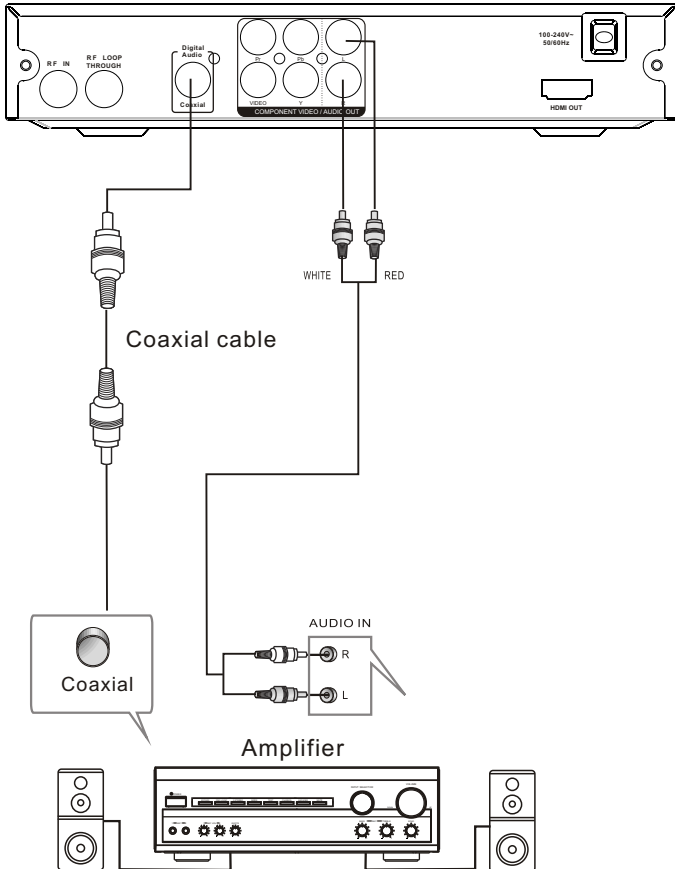

Connecting to a DVD Recorder or VCR

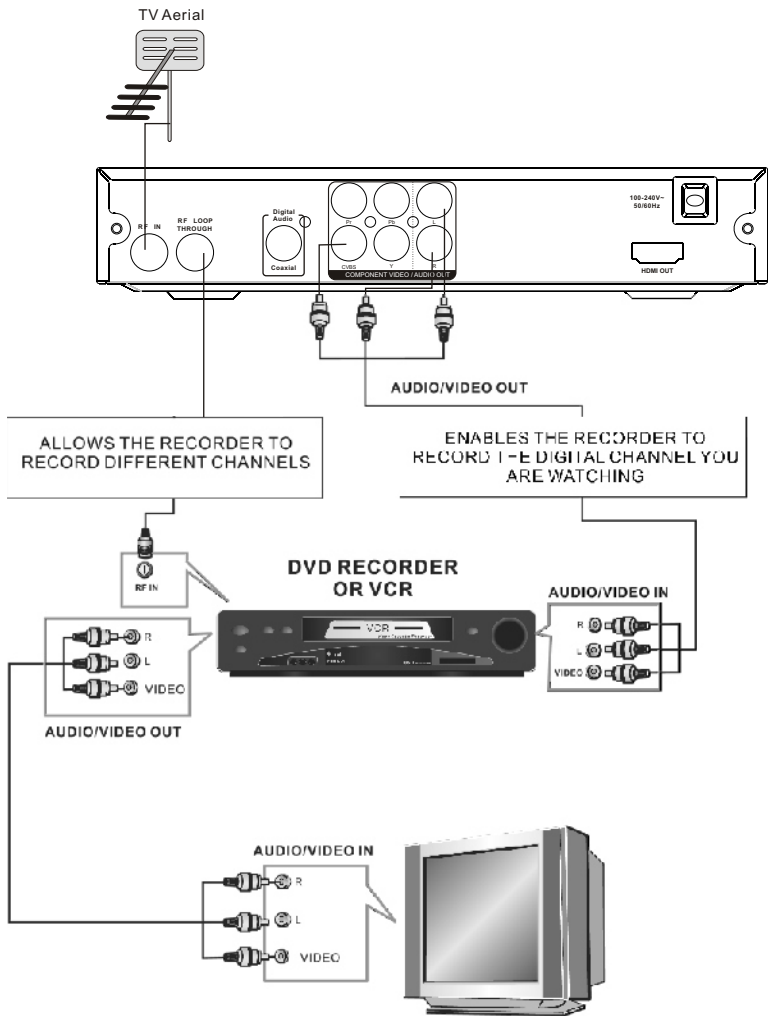

First Time Installation

After all connections have been made properly, switch on TV and make sure the receiver is connected to the Main Power. Press the Power button to switch receiver on. If you are using the receiver for the first time or have restored to Factory Default, the Installation Guide will appear on your TV screen.



- (1) Select [OSD Language] and Press the Navigate Buttons to select your desired language.
- (2) Select [Country] and Press the Navigate Buttons to select your desired country.
- (3) Select [Channel Search] and press RIGHT or OK key to begin Automatic channel search
- (4) Once channel tuning is complete, can begin watching TV.

Basic Operation

(1) Program Manage Settings

To access the Menu, press the MENU button and select [Program]. The Menu provides options to adjust the Program Manage Settings. Select an option and press OK or RIGHT to adjust that setting. Press the EXIT button to exit the Menu.

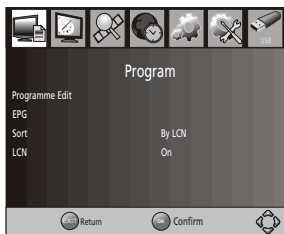

(2) Program Edit

To edit your program preferences (lock, skip, favourite, move or delete), you will need to enter the Program Edit Menu. This Menu requires a password to access. Enter the default password '000000'.



Set Favourite Program/s

You can create a shortlist of favourite programs that you can easily access. Set Favourite TV or Radio program:

1. Select the preferred program then press the FAVOURITE button.
A heart-shaped symbol will appear and the program is marked as a favourite
2. Repeat the previous step to select more Favourite programs
3. To confirm and exit the Menu, press the EXIT key

Disable Favourite TV or Radio Program:

Press the FAVOURITE button on the Remote Control with the heart-shaped symbol

View Favourite Programs:

1. Press the Favourite button and the Favourite Menu will appear
2. Press UP/DOWN to select your Favourite Programs
3. Press OK to select your favourite program

Delete a TV or Radio Program/s

1. Select the Program and then press the BLUE button
A message will appear. Press OK to delete the program
2. Repeat the previous step to select more programs to delete

Skip TV or Radio Program/s

1. Select the program you would like to skip and press the GREEN button
A skip symbol is displayed. The program is marked as a skip
2. Repeat the previous step to select more programs
3. To confirm and exit the menu, press EXIT key

Select the program with an Skip symbol, press the green button, the skip symbol will be taken off, then the program can be released from skipping.

Move a TV or Radio Program/s

1. Select the preferred program then press the RED button. A move symbol will appear
2. Press UP/DOWN to move the program
3. Press OK to confirm
4. Repeat the above steps to move more channels

Lock Program/s

You can lock selected programs for restricted view.

Lock a TV or Radio Program:

1. Select the preferred program then press the YELLOW button. A lock-shaped symbol is displayed. The program is now marked as locked
2. Repeat the previous step to select more programs
3. To confirm and exit the menu, press the EXIT button
4. Press the YELLOW button to disable the locked program
5. To view the locked program, you will be required to enter either the default password '000000' or your last set password.

(3) EPG (Electronic program guide)

The EPG is an on-screen TV guide that shows scheduled programs seven days in advance for every tuned channel. Press the EPG button on the Remote Control to access guide.

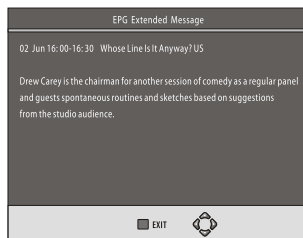
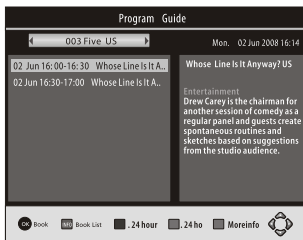

You can use the UP/DOWN key to select the preferred program. Press red button on the RCU to get -24 hours program list, press green button on RCU to get +24 hours program list. Press the blue button to get the detailed information of the selected program in full screen.

(4) Sort

Sort your channels from the following options:

- [LCN] - Sort the channels in ascending order
- [Name] - Sort the channels in alphabetical order
- [Service ID] - Sort the channels according to the station

(5) LCN (Logical channel number)

Set LCN on or off.

(6) Video Setting

To access the Menu, press MENU then select [Picture]. The Menu provides options to adjust the video settings. Press UP/DOWN to select an option and press RIGHT/LEFT to adjust that setting. Press EXIT to exit the menu.

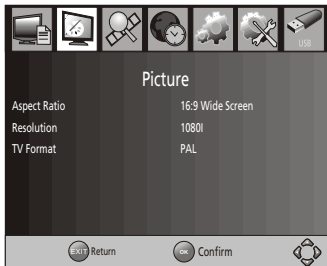

(1). Aspect Ratio

You must set the display format to either 4:3 PanScan, 4:3 Letter Box, 16:9 Full Screen or Auto to get the maximum display when watching TV.

(2). Resolution

If the video does not appear correctly, change the setting. This setting is to match the most common setting for HDMI.

[480i]: for NTSC system TV.

[480P]: for NTSC system TV.

[576i] for PAL system TV.

[576P]: for PAL system TV.

[720P]: for NTSC or PAL system TV.

[1080i]: for NTSC or PAL system TV.

(3). TV format

If the video does not appear correctly, you need to change the settings.

This should match the most common setting for TVs in your country.

[NTSC]: for NTSC system TV.

[PAL]: for PAL system TV.

(7) Channel Search

To access the menu, press MENU and select [Search Channel]. The Menu provides options to adjust the Search Channel settings.

Select an option and press RIGHT/LEFT to adjust the settings.

Press EXIT to exit the Menu



1. Auto Search

Search and install all channels automatically. This option overwrites all preset channels.

1. Select [Auto Search] and press OK or RIGHT to start channel search.
2. To cancel channel search, press EXIT.

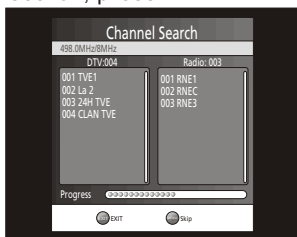

2. Manual Search

Install new channels manually. This option adds new channels without changing the current channels list.

1. Select [Manual Search] then press OK or RIGHT. The channel search screen will appear.

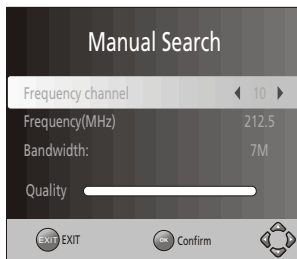

2. Press the RIGHT/LEFT key to select the channel frequency
 3. Press OK to start searching channels
- If a channel is found, it is saved and added to the channels list. If channels can't be found, then exit the menu.

(3) Country

Select your country of residence.

(4) Antenna power

Enable Antenna Power if an external active antenna is connected.

(8) Time Setting

To access the Menu, press MENU then select [Time]. The Menu provides options to adjust the time settings.

Press UP/DOWN to select an option and press RIGHT/LEFT to adjust the settings. Press EXIT to exit the menu.

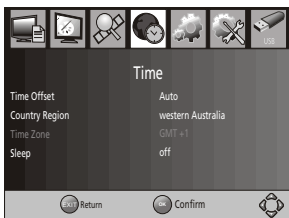

(1) Time offset

Select auto or manual for GMT offset adjustments.

(2) Country Region

Select the Country Region when [Time Offset] is set to Auto.

(3) Time Zone

Select the Time Zone Offset when [Time Offset] is set to Manual.

(9) Option

To access the Menu, press MENU and select [Option]. The menu provides options to adjust the OSD Language, Subtitle Language and Audio Language.

Select an option and press RIGHT/LEFT to adjust the setting.

Press EXIT to exit the Menu

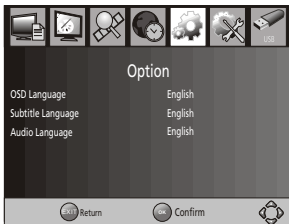

(1). OSD Language

Select an OSD language

(2). Audio Language

Select the preferred audio language for watching TV channels.

If the language is not available, the default program language will be used.

(3). Subtitle Language

Select the preferred subtitle language.

(10) System Setting

To access the Menu, press MENU and select [System]. The menu provides options to adjust the system settings.

Press the UP/DOWN key to select an option and press RIGHT/LEFT to adjust the setting.

Press EXIT to exit the Menu .

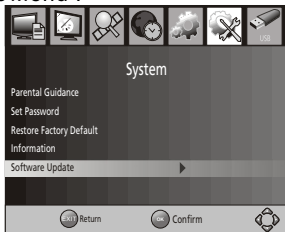

(1) Parental Guidance

You can restrict access to channels that are unsuitable for children. To restrict/lock the channel you will need to enter either the default password '000000' or your own password.

(2) Set Password

Set or change the password for locked programs. Enter your old password or the default password '000000'. You will then be asked to enter your new password. To confirm re-enter your new password. Once it is confirmed, press EXIT to exit the Menu.

(3) Set Parental guidance

Press Menu button to access menu and Select System, choose parental guidance, input your password and set the level. Then icon of the PG level will be shown in the info bar of the program.

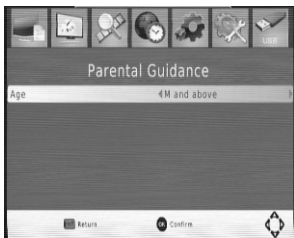

(3) Restore Factory Default

Reset your Set Top Box to the Default Factory Settings.

In Main Menu select [Restore Factory Default] and press OK or RIGHT to select. Enter your password or the default password '000000' and press OK to confirm. This option will delete all preset channels and settings.

(4) Information

View model, hardware and software information.

(5) Software Update

When this option is set to "On", the Set Top Box will begin to search for new software automatically, from over air broadcasts based on your set time in "Start Time".

(11) USB

To access the Menu, press the **MENU** button and select [USB]. The menu provides options to playback Music and Photo files, it can support MP3, WMA, JPEG, BMP files, The unit will only support USB device with FAT and FAT32 file system. It will not support NTFS file system.

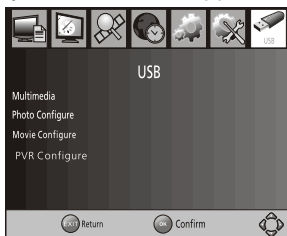

(1) Multimedia: Once your USB is plugged in, you can select the Music or Photo type in the multimedia menu. Press OK to enter the file browser and select the file you wish to play.

Please note: If no USB device is plugged in, a warning message "No USB Device is Found" will be displayed.



(2) Photo configure:

You can select one of the following settings to for your photo slideshow options.

-**Slide Time:** You can adjust slideshow interval from 1~8 seconds.

-**Slide Mode:** You can adjust slide show effect as mode 0~59 or random.

-**Aspect Ratio:** You can displays the picture as its original aspect.

- Discard displays the picture in full screen mode.

- Subtitle Specific:

[Small]: Displays the subtitle as small mode.

[Normal]: Displays the subtitle as normal mode.

[Big]: Displays the subtitle as big mode.

- Subtitle BG:

[White]: Displays the subtitle in white background.

[Transparent]: Displays the subtitle in transparent background.

[Grey]: Displays the subtitle in grey background.

[Yellowgreen]: Displays the subtitle in yellowgreen background.

- Subtitle Font Color:

[Red]: Displays Subtitle in red font.

[Blue]: Displays Subtitle in blue font.

[Green]: Displays Subtitle in green font.

Note:

- We cannot guarantee compatibility (operation and/or bus power) with all USB mass storage devices and assumes no responsibility for any loss of data that may occur when connected to this unit.

- With large amounts of data, it may take longer for the system to read the contents of a USB device.

- Some USB devices may not be properly recognized.

- Even when they are in a supported format, some files may not play or display depending on the content.

USB Recording:

The most unique feature on your Set Top Box is its ability to record live TV. You can simply connect a USB storage device or Hard Disk Drive to your Set Top Box and press the record button on the remote control.

We recommend that you use a powered hard disk drive, as USB sticks only allow limited functionality. If you decide to use a USB stick please ensure it has over 2GB of recordable space.

With the Record Function you can record Live TV at anytime. Follow the below steps to activate this function.

1. Press the Record Button to activate Record function.
2. The recorded program can be played in 2X speed by pressing fast forward/ rewind Button for first time, in 4X speed for second time, in 8X speed for third time, in 16X speed for fourth time, in 32X speed for fifth time.
3. You can display information of the recorded program will be displayed by pressing the 'INFO' Button while in full-screen playback.
4. To exit the recorded program press the stop button.

Time shift

Make sure that a USB or Hard Disc Drive device is connected to the receiver in order to be able to use the time shift function.

We recommend that you use a powered Hard Disk Drive as USB Sticks will only allow limited functionality.

Please ensure that the USB Memory used has a memory capacity of above 2 GB.

With the Timeshift Function you can pause and continue Live TV at anytime you like without having to miss any action. Follow the below steps to activate this function.

1. Press the Pause Button to activate Timeshift and pause Live TV. You can press play at anytime to resume play.
2. You can fast forward the playback at anytime until returning to live TV, or press the stop button to exit timeshift mode.



Troubleshooting

Problem	Potential Reasons	What to do
No picture	Power isn't connected	Connect the power
	The power switch is not on	Switch on the power
Screen shows "No Signal"	DVB-T cable not connected	Plug in the DVB-T cable
	Incorrect setting	Conduct a factory reset
No sound from speaker	No or incorrect connection with audio cable	Connect the audio cable correctly
	Sound on mute	Turn off mute function
	Adjust the volume.	Volume is set to low
Only sound, no image on the screen	No or incorrect connection with AV cable	Make sure cables are connected correctly
	The program is a radio program	Press <TV/RADIO> key to shift into TV mode
Remote Control is not responding	The battery is exhausted	Change battery
	Remote Control is not facing or close enough to the Set Top Box	Adjust the position of the Remote Control and move closer to the unit
The image stopped suddenly or mosaic	The signal is too weak	Conduct a Factory Reset
USB not responding	USB is not connected properly or does not sufficient memory	Reconnect the USB or connect another USB

Technical Specifications

Item	Sub Item	Parameter
Tuner	Input Frequency	170~230MHz 470~860MHz
	RF Input level	-25~-78dBm
	IF Bandwidth	7MHz and 8MHz
	Modulation	QPSK,16QAM,64QAM
Video	Decoder Format	MPEG4 AVC/H.264 HP@L4 MPEG2 MP@ML.HL
	Output Format	576P , 720P, 1080i, 4:3 and 16:9
	Output Port	HDMI
Audio	Decoder Format	MPEG-1 (layer1&2)
	Audio output	Digital audio: S/PDIF
Power	Voltage	230V~ 50Hz
	Power	Max 8W



 This symbol on the product or in the instructions means that your electrical and electronic equipment should be disposed at the end of life separately from your household waste. There are separate collection systems for recycling . For more information, please contact the local authority or your retailer where you purchased the product.

Warranty

Please keep your receipt as proof of purchase. This product is warranted for any defect in materials or workmanship for one year after the original date of purchase. This product is for normal domestic and office use only. This warranty does not cover damage from misuse or neglect, accidental damage, vermin infestation, excessive voltages such as lightning or power surges or any alteration that affects the performance or reliability of the product.

In the unlikely event that your product fails to work normally, please contact the Bush Warranty on **1800 509 394 (Australia)** or **0800 450 259 (New Zealand)** and have your receipt of purchase on hand.

This warranty is subject to the following provisions:

- It is only valid within the boundaries of the country of purchase.
- The product must be correctly assembled and operated in accordance with the instructions contained in this manual.
- The product must be used solely for domestic purposes.
- The warranty does not cover accidental damage, misuse, cabinet parts or consumable items.
- The warranty will be rendered invalid if the product is resold or has been damaged by an inexperienced repair.
- The manufacturer disclaims any liability for incidental or consequential damages.

This warranty is in addition to, and does not diminish, your statutory or legal rights.

PO BOX 6287,
SILVERWATER NSW 1811
www.bushaustralia.com.au
Bush Warranty: 1800 509 394 Australia
Bush Warranty: 0800 450 259 New Zealand

PO BOX 6287,
SILVERWATER NSW 1811
www.bushaustralia.com.au