

Operation and Installation Manual

For M741 Series

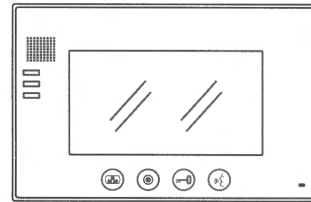

Model:M741

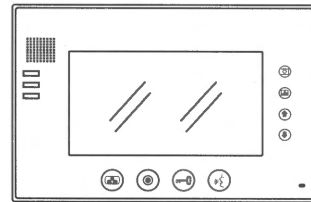

Model:M741M

With picture memory function



CONTENTS

Indoor monitor 2D drawing.....	2
Specification.....	3
Wiring diagram.....	4
Installation instruction.....	5
Installation diagram.....	6
Configuration diagram.....	7
System diagram.....	8
Operation.....	9
Visitor calling.....	9
Unlocking.....	9
Monitoring.....	10
Indoor monitor call transferring.....	10
Picture Memory Function	11
Note.....	13

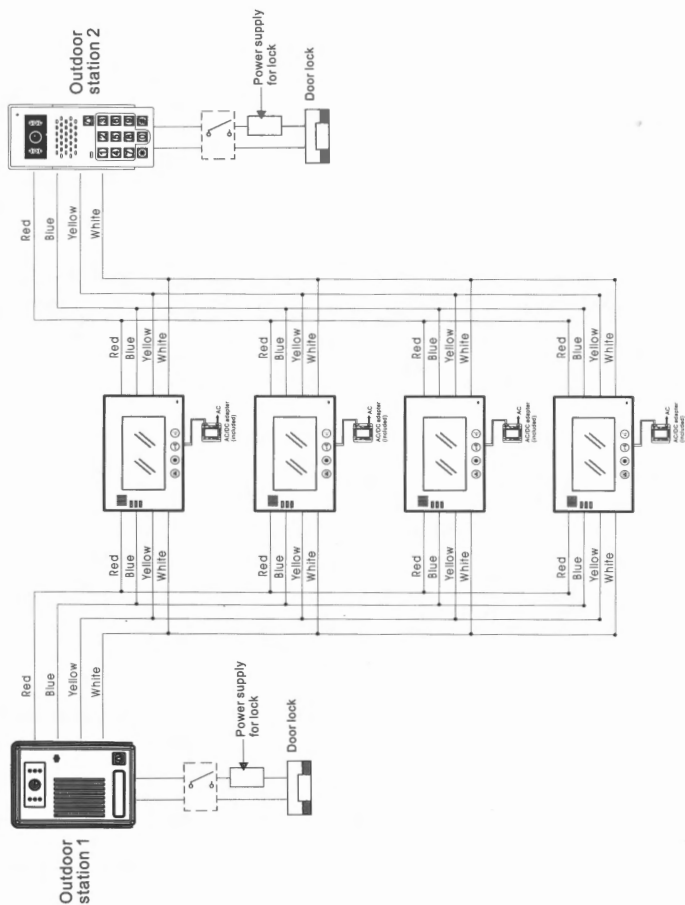

▶ Indoor monitor 2D drawing

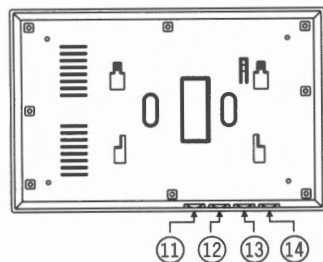
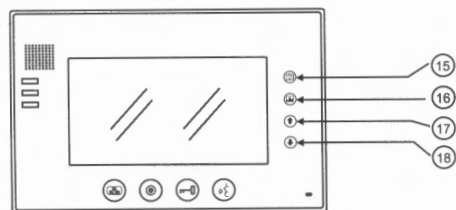
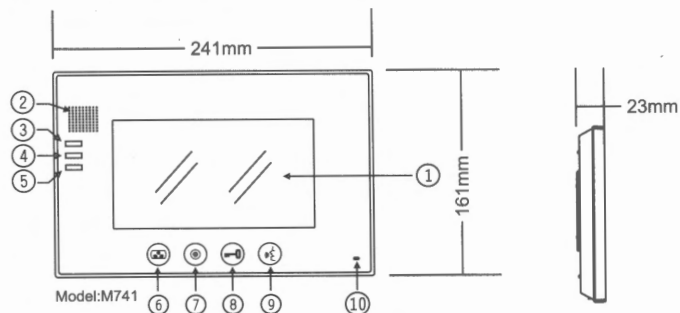

NO.	Function	NO.	Function
①	TFT	⑩	Microphone
②	Speaker	⑪	Brightness
③	Power and talking indicator	⑫	Chroma
④	Door 1 calling indicator	⑬	Volume
⑤	Door 2 calling indicator	⑭	Ring adjust
⑥	Monitor(Touch button)	⑮	Manual capture picture
⑦	Calling(Touch button)	⑯	Picture review
⑧	Unlock(Touch button)	⑰	Page up
⑨	Talking(Touch button)	⑱	Page down

▶ Specification

Working condition	Temperature: -10 ~ +55℃
	RH < 95%
Voltage	DC14.5V
Standby current	≤ 50mA
Working current	≤ 600mA
Mode	Dual transmission
Talking time	2 minutes

► Wiring diagram

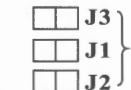

Short circuitJ3:
Night light of
outdoor station
Short circuitJ1:
Ringing output
Short circuitJ2:
Video

Connected with
outdoor station2



CN2



CN1

Connected with
outdoor station1

1.red 2.blue 3.yellow 4.white 5.red 6.black
1-AUDIO 2-GND 3-POWER+ 4-VIDEO
5-POWER+ 6-POWER GND

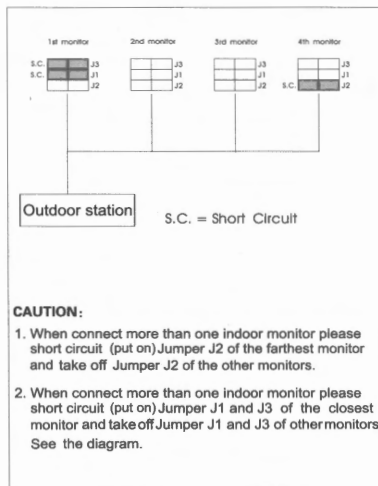

CAUTION:

- When connect more than one indoor monitor please short circuit (put on) Jumper J2 of the farthest monitor and take off Jumper J2 of the other monitors.
- When connect more than one indoor monitor please short circuit (put on) Jumper J1 and J3 of the closest monitor and take off Jumper J1 and J3 of other monitors. See the diagram.

► Installation instruction



- The installation place should be faraway from TV, video record player, PC etc. Electronic units with high intensity EMC.
- Do not drop, knock or shake the unit.
- Shut down the power for the unit while installing.
- The wiring cable installation should keep 30 cm away from the high voltage cable as minimum distance, reducing the disturb from high voltage.
- Before take power for the unit, recheck the wiring diagram and make sure done right connection.
- Meet with unnormal phenomenon when the unit is working, cut down the power first and then do eliminate of defects.
- Eliminate of defects after shut down the power, do check step by step from one unit to another unit, or do cross-test that means take substitute(a new one). After done above processings, if still has unknown defect, contact with our company for after service. Nonexpertive handing may damage the unit.

Installation processes

- Position the location when the unit is to be mounted. Use the bracket to mark the accurately location point.
- Use the screw anchors to fill the drilling hole, and screwing fasten the bracket to the wall.
- According to the wiring diagram and do right connection.
- Mounted the unit to the bracket.

Installing diagram

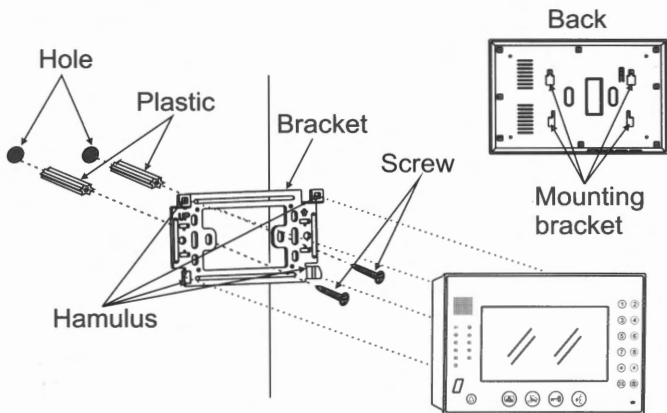

INSTRUCTION:

1. Cables of requirement:
Diameter $\geq 0.5\text{mm}^2$, from outdoor station to the farthest monitor distance $\leq 70\text{m}$.
2. Each monitor should be parallel connected. One monitor can be extended 3 monitors as maximum extension. One monitor can be connected 2 outdoor stations as maximum.

CONFIGURATION DIAGRAM

- ▶ WITH TWO ENTRANCE
Indoor monitor external power supply

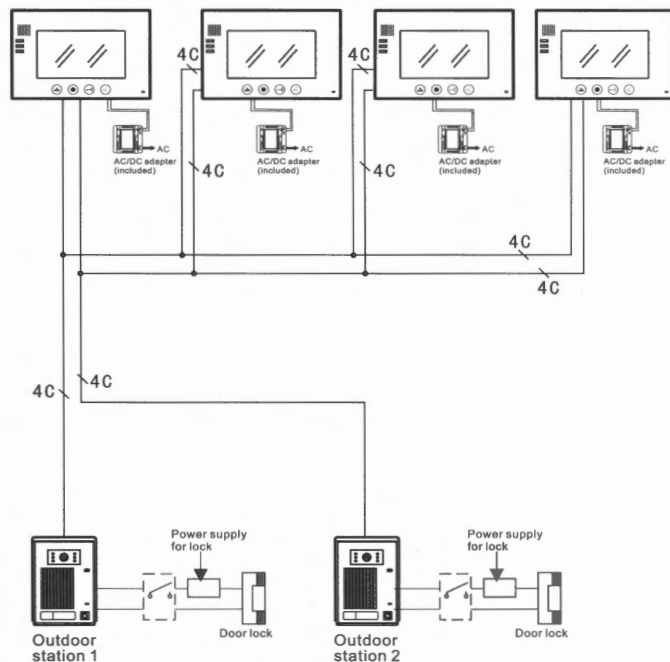

SYSTEM DIAGRAM

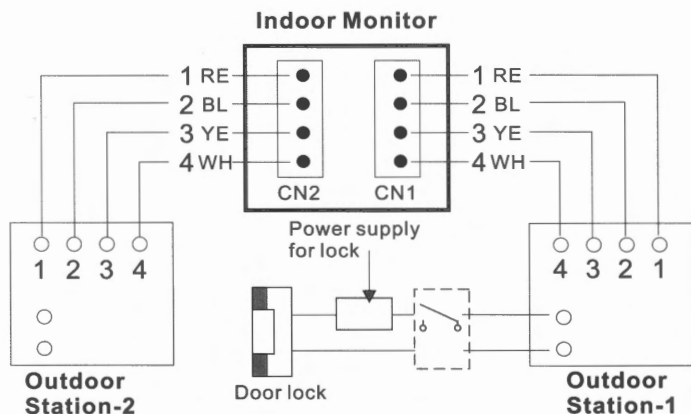

► Wiring connections

1. Red 2. Blue 3. Yellow 4. White
1-Audio 2-GND 3-Power+ 4-Video



OPERATION

► Visitor calling



Visitor press the call button of outdoor station, all indoor monitor showing the indicator of the outdoor station position and ringing, and visitor image on the indoor monitor display panel. Press the button  of any indoor monitor, start talking, same time, other indoor monitor can press the button  achieve to third-party call, repress the button  of any indoor monitor close the talking and all display of all indoor monitor closed. Max talking time lasts 2 minutes, no answer, calling last 1 minutes. One-one talking mode, means one indoor monitor talk to one outdoor station, other indoor monitors will just show the visitor, at same time, press the call button from other outdoor station, one-one talking will cut, and the latest called outdoor station start talking to the indoor monitor. Corresponding indicator flashing in case outdoor station calling.

► Unlocking

Calling from outdoor station to indoor monitor, the indoor monitor will be ringing and talking indicator LED on, the visitor's image will be displayed on the screen. Press the button  for unlocking the door.



In monitoring mode, press the button  for unlocking the door.

► Monitoring

In standby mode, press the button , meanwhile Door 1 indicator of indoor monitor flashing and showing the scenery of Door 1 outdoor station's camera. Press the button  again, will show scenery of Door 2 outdoor station's camera. Press the button  third time, close monitoring. Without the third press, monitoring will be closed in 1 minutes automatically.

In monitoring mode, press the button  on indoor monitor can start audio monitoring. Monitoring mode last 1 minutes and each indoor monitor independently of each other.

► Indoor monitor call transferring

In case press the call button on outdoor station, all indoor monitor ring, can be pressed any indoor monitor button  for talking, also can be pressed the button forward the calling for other indoor monitor, the indoor monitor you pressed the button  close the talking and standby.

Notes:

1. In this system, in case be connected multi-indoor monitors, just the farthest indoor monitor jumper J2 need put ON, others' keep default setting.
2. Put on jumper J1 the outdoor station has ringing tone, or else, has no voice.
3. Put on jumper J3 means the outdoor station nightlight on, or else, nightlighting function closed.

Picture Memory Function

For the models with picture memory function



Auto capture

In the calling status or in the monitoring status, the monitor screen will turn on automatically.

The outdoor station will capture one picture in the third second and store it automatically after the indoor monitor screen is on.

It only captures one picture automatically (Do not support automatic continuity capture).



Manual capture

In the calling status or in the monitoring status, when the monitor screen displays image well, press  to capture a picture. The picture will be saved automatically.







NOTICE

Maximum storage: 400 pictures. After the number of pictures reaches 400, the oldest picture will be deleted automatically as long as a new picture is captured.



Picture review



Picture review page: Press , maximum six pictures in one screen. Press  or  to select a picture. Selected picture has yellow borders. Press , zoom in the selected picture; press , return to picture review page. The picture appears for ten seconds without any operation, and then the Picture Review page will exit. The indoor monitor will automatically return to the standby state.

Picture deleted





In the picture review status: Press , the selected picture is deleted. In the monitoring status: Press  and hold for three seconds, all the pictures are deleted.

Time calibration



Press  and hold for three seconds,
2011 - 01 - 01 00 : 00
Year - Month - Date Time

YEAR: the last two figures keep flashing, press  and  to adjust figures; Press  to confirm and move to MONTH.

MONTH: figures keep flashing, press  and  to adjust figures; Press  to confirm and move to DATE.

Referring to the above steps to adjust the DATE, HOUR and MINUTE. In ten seconds without any operation, the time calibration will automatically exit and the indoor monitor will return to the standby state.



Notice

1. Do not put the unit near the magnetic area such as television, video recorder etc.

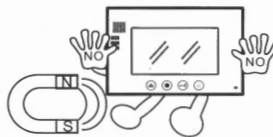

2. Keep the unit dry, humidity and all types of liquids or moisture contains mineral that will corrode electronic circuits.

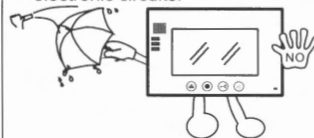

3. Do not put the unit in hot areas. high temperatures can shorten the life of electronic device.



4. Do not drop, knock or shake the unit.



5. Do not attempt to open the unit. Nonexpert handling may damage the unit.

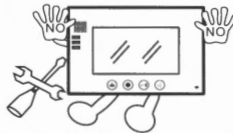

6. Do not use the wet dishcloth or the volatile cleansers to clean it.

