

silver schmidt

Operating Instructions SilverSchmidt & Hammerlink



proceq

Table of Contents

1. Safety and Liability	3
2. Getting started	4
2.1 SilverSchmidt Basics	4
2.2 Components of the SilverSchmidt	5
2.3 The SilverSchmidt Display	6
2.4 Philosophy of the User-Interface	7
2.5 Correct Use of the Hammer	7
3. Optional Settings	8
3.1 Units	8
3.2 Statistics	8
3.3 Conversion Curve	9
3.4 Form Factor	9
3.5 Carbonation Correction Factor	10
3.6 Checking the current Settings	10
4. Applications	11
4.1 Uniformity Assessment	11
4.2 Estimation of in-situ compressive strength	12
4.2.1 Carbonation	12
4.2.2 Using Form Factors with SilverSchmidt	13
4.2.3 Testing low strength concrete	14
5. Operating the Instrument	16
5.1 Single shot mode	16
5.2 Measurement Series	17
5.3 Delete the last impact (Outlier)	18
5.4 Working with the data list	18
6. Ordering Information	19
7. Technical Specifications	20
8. Maintenance and Support	21
9. Starting Hammerlink	22
9.1 Viewing the data	23
9.2 Adjusting the settings	24
9.3 Adjusting the date and time	24
9.4 Exporting data	25
9.5 Deleting and restoring data	26
9.6 Further functions	26
9.7 Custom statistics	27
9.8 Custom curves	28

1. Safety and Liability

Safety and usage precautions

This manual contains important information on the safety, use and maintenance of the Silverschmidt. Read through the manual carefully before the first use of the instrument. Keep the manual in a safe place for future reference.

Liability and warranty

Proceq's "General Terms and Conditions of Sale and Delivery" apply in all cases. Warranty and liability claims arising from personal injury and damage to property cannot be upheld if they are due to one or more of the following causes:

- Failure to use the instrument in accordance with its designated use as described in this manual.
- Incorrect performance check for operation and maintenance of the instrument and its components.
- Failure to adhere to the sections of the manual dealing with the performance check, operation and maintenance of the instrument and its components.
- Unauthorized structural modifications to the instrument and its components.
- Serious damage resulting from the effects of foreign bodies, accidents, vandalism and force majeure.

All information contained in this documentation is presented in good faith and believed to be correct. Proceq SA makes no warranties and excludes all liability as to the completeness and/or accuracy of the information.

Safety instructions

The instrument is not allowed to be operated by children or anyone under the influence of alcohol, drugs or pharmaceutical preparations. Anyone who is not familiar with this manual must be supervised when using the instrument.

Labelling

The following icons are used in conjunction with all important safety notes used in this manual.



Note:

This symbol indicates important information.

Correct Usage

- The instrument is only to be used for its designated purpose as describe herein.
- Replace faulty components only with original replacement parts from Proceq.
- Accessories should only be installed or connected to the instrument if they are expressly authorized by Proceq. If other accessories are installed or connected to the instrument then Proceq will accept no liability and the product guarantee is forfeit.

2 Getting started



Note: When shipped, battery packs are not fully charged. Prior to use, please charge the battery completely. To prevent the battery from damage, avoid deep-discharging or storing it long-term when empty. Store the instrument at room temperature and charge the battery fully at least once a year.

2.1 SilverSchmidt Basics

Charging the SilverSchmidt

In the case of a low battery alert, you can still record approximately 100-200 impacts. To recharge, connect the SilverSchmidt to the charger or to a PC. Approximately 90 minutes of charging will bring your SilverSchmidt to its full capacity.

Power ON

Press the SELECT button to power on.

Plunger USB port LCD display SELECT button



Check the calibration of the hammer

Perform a calibration check on your hammer as described in chapter 8.

Performing a reset

In case a reset is required, perform an impact with the SELECT button pressed.

This will reset any parameter settings to the defaults.

Should your instrument be fully discharged, start with a reset after recharging.

Power OFF

The SilverSchmidt will shut down automatically after 5 minutes of inactivity.

Standards and guidelines applied

SilverSchmidt complies fully with **EN 12504-2** and **EN 13791**.

The following standards have been applied in SilverSchmidt for the procedure to determine the rebound number: **ASTM C805**, **JGJ/T 23-2011**.

SilverSchmidt Models

- ST** Standard model. Software supplied for performing firmware upgrades and selecting statistics presets only. Useful memory limited to the last 20 series
- PC** Full Hammerlink software functionality. Extended memory usage. Download to PC. User defined custom curves.
- N-Type** Standard impact energy. The test object should have a minimum thickness of 100mm and be firmly fixed in the structure.
- L-Type** Low impact energy, suitable for brittle objects or structures less than 100 mm thick.

2.2 Components of the SilverSchmidt



Full electronic module

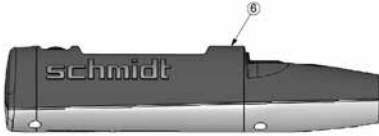

Housing



Full mechanical module type N

Parts

- | | | | |
|---|----------------------------|-----|---------------------------------|
| 1 | SELECT button | 7.1 | Battery board incl. battery |
| 2 | Cover for USB port | 8 | Mechanical module complete |
| 4 | Plunger complete | 9 | Hammer guide bar and guide disc |
| 5 | Guide sleeve complete | 10 | Impact spring |
| 6 | Housing | 11 | Loading spring holder complete |
| 7 | Electronic module complete | 12 | Loading spring |
| | | 13 | Hammer mass |

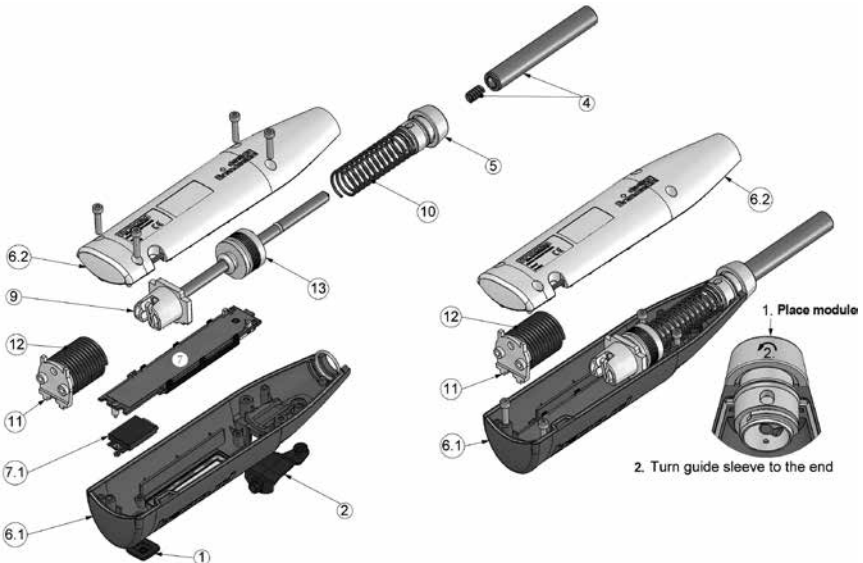

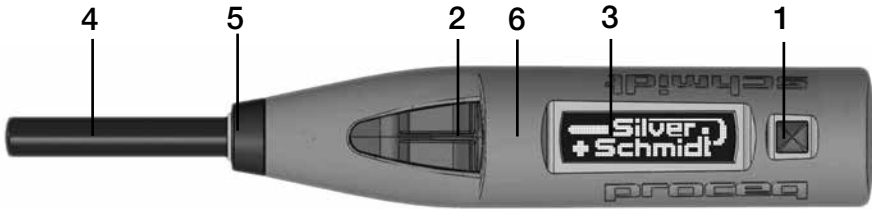

- | | | |
|------------------|----------------|-----------------------|
| 1. SELECT button | 3. LCD display | 5. Guide sleeve (cap) |
| 2. USB port | 4. Plunger | 6. Housing |

2.3 The SilverSchmidt Display

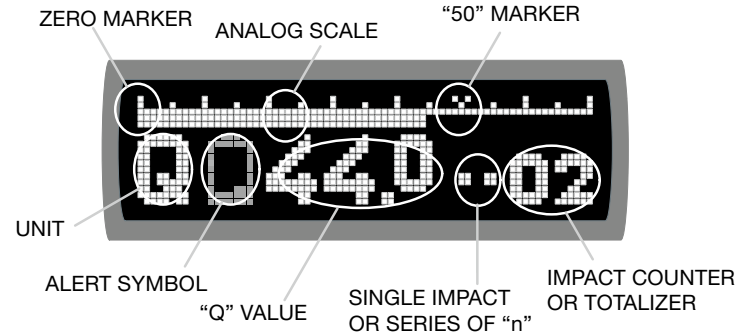
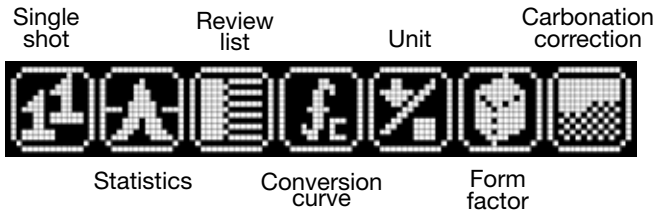

A typical display after an impact shows:

- The actual “Q”-value with a two and a half digit number
- A pseudo-analog scale mimicking the mechanical drag pointer.
- A counter either displaying the last two digits of the 4 digit totalizer or the actual number of valid impacts in a series of measurements.

2.4 Philosophy of the User-Interface

The user-interface of the SilverSchmidt is based on a straightforward menu structure. Each menu item has its own descriptive **ICON** making it language independent.

- **TILT** – Tilting the device means that you raise the left side (plunger side) of the device to scroll to the icons to the left of the “centered” icon or you raise the right side of the device (SELECTOR button side) to scroll to the icons to the right of the “centered” icon.
- **ROLL** – Rolling the device means that the device remains in the horizontal position, but the display is rolled away from you or towards you.
- **SELECT** - Press the SELECT button.
- **TIP** – Depress the plunger a short distance, but not enough to trigger it.
- **IMPACT** – Depress the plunger until it triggers.

These simple actions are all that is required to navigate around the menu, set-up the SilverSchmidt, perform measurements and review results and settings.

2.5 Correct Use of the Hammer



Use the grinding stone to smoothen the test surface. Perform a few test impacts with the concrete test hammer on this smooth, hard surface before taking any measurements which you are going to evaluate. Perform a consistency check on the test anvil.



The number of test impacts required for a valid rebound number is defined in the standards. Typically this will be at least nine impacts. The individual impact points must be spaced at least 25 mm apart. Push the concrete test hammer against the test surface at moderate speed until the impact is triggered.



Note: The plunger generates a recoil when it deploys. Always hold the concrete test hammer in both hands, perpendicular to the test surface, before you trigger the impact!

3. Optional Settings

After selecting each of the optional settings defined below you will be asked to confirm or cancel the setting.

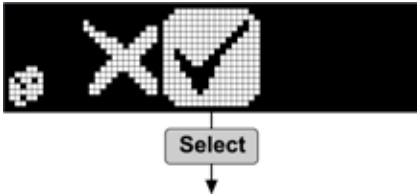

3.1 Units

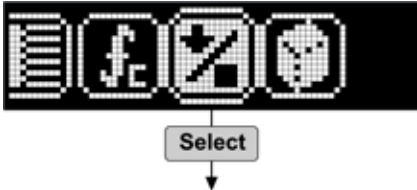

Select the units for compressive strength estimates.



Q, kg/cm², N/mm², psi, MPa

3.2 Statistics

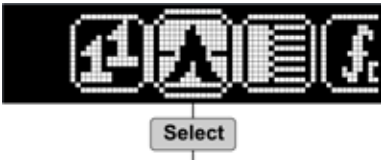

Select a preset statistics method.

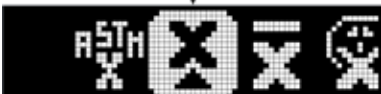

Regional*, Median, Mean, User preset*

In the example, the regional setting in this case is ASTM C805. Another symbol may be present depending on the region. (e.g. JGJ for China.)

The median setting is in accordance with EN 12504-2. Requires a minimum of 9 impacts from which a median is calculated. The series is invalid if more than 20% of the values differ from the median by more than 30%.

The ASTM method requires 10 impacts from which a mean is calculated. The series is invalid if more than 20% of the values differ from the mean by more than 6.5 Q.

The JGJ method requires 16 impacts. The 3 upper and lower outliers are deleted and a mean is calculated from the remaining 10.

User preset is defined using “Custom Statistics” in Hammerlink, see 9.7.

3.3 Conversion Curve



Select a conversion curve.

Select



10th percentile, Reference, Custom curve (PC Model only)
Custom curves are defined in Hammerlink.

Select



Step not required if 10th percentile, reference curve is selected.

Select

3.4 Form Factor

For advice on the use of form factors, refer to 4.2.2.



Cylinder, Standard cube, User defined

Select



Step not required if standard cube or cylinder selected.

Select



Tilt to set the user defined form factor based on the local standard.

Select

3.5 Carbonation Correction Factor

For advice on carbonation correction, refer to 4.2.1.

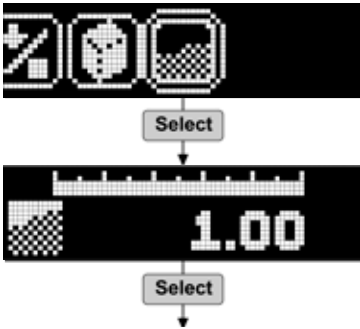

Tilt to set the user defined carbonation correction factor, determined as described in 4.2.1.

3.6 Checking the current Settings

The current settings will be displayed when you apply the end of the plunger against the concrete (or any firm) surface and slightly push (**TIP**). You can review the settings at any time – they are displayed momentarily and will not affect any current testing or settings. The display format is shown below.

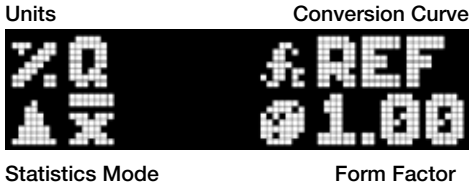

4. Applications

4.1 Uniformity Assessment

The SilverSchmidt is primarily used to assess the uniformity of concrete strength within a structure and to localize areas of inferior quality. Typically the procedure is as follows, but the user is advised to refer to local standards for the variations in this procedure to be followed in the particular region. Heavily textured surfaces, soft surfaces or surfaces with loose mortar should be prepared with the grinding stone to provide a smooth test surface.

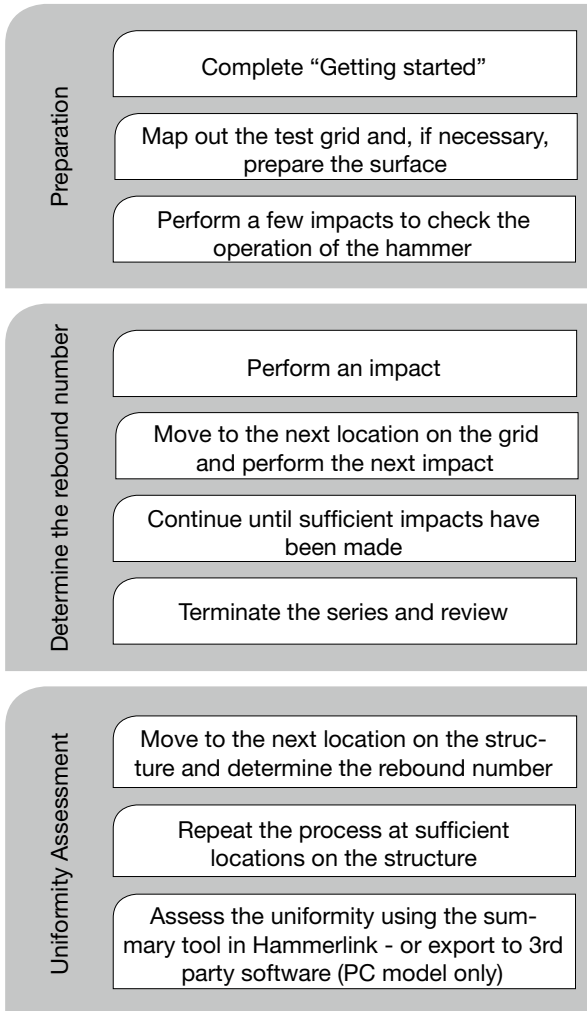

4.2 Estimation of in-situ compressive strength



Note: When using a rebound hammer to estimate in-situ compressive strength, the reference curve(s) provided by the manufacturer must be used with some caution. The correlation between rebound number and compressive strength is very much dependent on the concrete mixture under test. Details on the derivation of reference curve(s) used in the SilverSchmidt are provided in the document “The SilverSchmidt Reference Curve” which can be found on the CD. The user is advised to take this into account when deciding on the suitability of the reference curve chosen to the concrete under test.

In order to obtain an estimate of in-situ compressive strength using a rebound hammer in accordance with the major standards, a calibration is necessary. Independent testing has shown that the SilverSchmidt can give a better correlation with lower dispersion than a classical hammer when calibrated for a specific mix. The recommended method is to correlate the rebound hammer measurements with destructive tests made on core samples, or cubes/cylinders made from the same concrete mixture as that used in the structure.

Please refer to the following standards and guidelines for details of the requirements for creating such a correlation curve.

- EN 13791 (Europe), ASTM C805, ACI 228.1R-03 (North America), JGJ T23-2001 (China) The resulting data is used either to shift a reference conversion curve or to define a custom curve for that particular mix. Typically the curve is defined to provide a safety margin to take into account the various factors, that may affect the in-situ tests. EN 13791 recommends the use of a lower 10th percentile curve. This means that 90% of the data pairs lie above the curve and only 10% lie below.
- ASTM C805 refers to the guideline ACI 228.1R-03. In chapter 6 of this document a simplified method “6.2.4 Alternative method (Carino 1993)” which takes into account the uncertainties of both the rebound method and the destructive testing of the core samples is presented. Again a lower 10th percentile curve is recommended.

Such custom curves, either polynomial or exponential, may be defined in Hammerlink and downloaded onto the SilverSchmidt PC making it the ideal instrument for carrying out such tests. An Excel Macro “SilverSchmidt Correlation” is provided with the documentation to assist in obtaining the parameters for custom curves.

4.2.1 Carbonation

Carbonation forms a hardened layer on the surface and as this layer increases it can lead to a significant over-estimation (possibly as high as 50%) of the compressive strength of the underlying concrete when measuring with a rebound hammer. The depth of the carbonation layer can be simply determined using an indicator solution of phenolphthalein in ethanol. The indicator is simply sprayed onto a fresh fracture surface or core sample.

A non-carbonated layer with a pH of > 9.2 shows purple.
 A carbonated layer with a pH < 9.2 shows colourless.

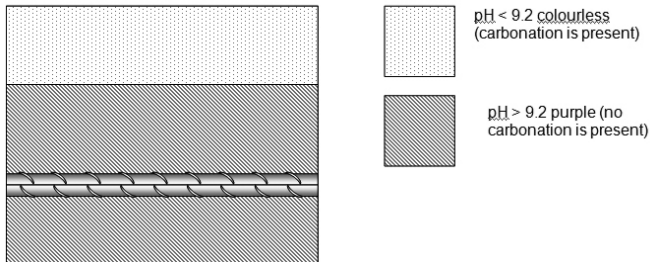

A number of recommendations describe the procedure for carrying out a carbonation test. Two are mentioned here.

- DAfStb: Prüfung von Beton, Empfehlung und Hinweise als Ergänzung zu DIN 1048, Heft 422, Berlin, 1991
- RILEM recommendation CPC 18. Measurement of hardened concrete – Carbonation depth.

Either the carbonated layer must be removed before rebound testing, or the rebound test should be carried out before and after removal of the carbonated layer using a grinding machine over a surface area of about 120mm diameter. This allows a correction factor to be considered. (Sometimes referred to as a “Time Coefficient”).

$$\text{Time coefficient } Z_f = f_{c, n.c} / f_{c, carb.}$$

- $f_{c, n.c}$: Estimated compressive strength measured on non-carbonated concrete surface
- $f_{c, carb.}$: Estimated compressive strength measured on carbonated surface

A correction factor obtained in this way may be used to compensate the result obtained in other areas of the structure subject to similar exposure conditions. Enter the carbonation correction factor directly onto the SilverSchmidt as described in 3.5.

4.2.2 Using Form Factors with SilverSchmidt

The standard compressive strength is determined on standard tests specimens which are typically either cubes or cylinders. For example EN 206-1 refers to: $f_{ck, is, cube}$ (characteristic in-situ compressive strength expressed in the equivalent strength of a 150mm cube), $f_{ck, is, cyl}$ (characteristic in-situ compressive strength expressed in equivalent strength of a 150 mm x 300 mm cylinder). The SilverSchmidt uses a 150 x 150 x 150 mm cube as standard reference to convert from the averaged Q-value to compressive strength. In regions where the 28 strength is not determined on such standard cubes, this value has to be multiplied by a suitable form factor to obtain comparable results.



The form factor implementation in SilverSchmidt is in line with the recommendations given in the major standards with the options: Standard cylinder, standard cube or user defined

The default value is the standard cube (150 mm). This has a form factor of 1. The factor used for the standard cylinder is derived from the information in EN 206-1 Table 7 “Compressive strength classes for normal-weight and heavy-weight concrete.” This may be applied for all concrete mixtures above 2000 kg/m³. The form factor for the standard cylinder ranges from 0.8 to 0.87.

The third option is a user defined setting which can be freely selected in the range 0.8 – 1.2. This option has been included as the major standards differ on the implementation of form factors. The user should consult the applicable standards and enter the recommended form factor accordingly.

4.2.3 Testing low strength concrete

The mushroom plunger accessory is designed to operate exclusively with the Silver-Schmidt PC Type L (Part No. 341 41 000), for measuring on fresh or low strength concrete.



The mushroom plunger accessory is a consumable item and as such is not covered by the standard 6 month guarantee for mechanical parts. However, provided the user follows the simple precautions outlined below, prolonged, consistent performance can be expected.

Precautions when using the mushroom plunger:

- Only use the mushroom plunger with the SilverSchmidt PC type L hammer. (Part No. 341 41 000)
- The mushroom plunger is intended for use on fresh or low strength concrete.
- Never use the mushroom plunger on concrete with a compressive strength above the specified range.
- The surface should be smooth. If necessary prepare with a grinding stone before impacting.
- Due to the special geometry of the plunger tip, it is susceptible to damage if impacting at an angle. Impacts should only be carried out perpendicular to the surface in a smooth, controlled manner.

Technical Specifications

Range	5 MPa to 30 MPa
Impact energy	0.735 Nm

Conversion Curve

In all cases Proceq recommend to calibrate the hammer with the mushroom plunger for the specific mix under test and to program a custom curve into the hammer for in-situ testing. This is not always possible, so an example curve is provided here. It is based on limited data collected during testing carried out by the Federal Institute for Materials Research and Testing in Berlin, Germany. (BAM – Bundesanstalt für Materialforschung u. –prüfung) and by Proceq Engineers at EMPA.

The Lower Limit

Limited data has been collected on very low strength concrete. For this reason the example curve has been limited to the range 5-30 MPa.

Example conversion curve for SilverSchmidt ST/PC Type L with Mushroom Plunger

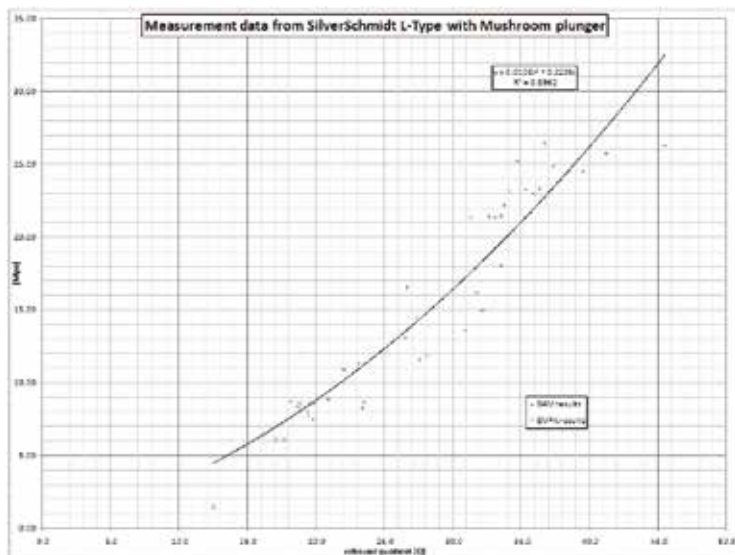

$$f_{ck} = aQ^3 + bQ^2 + cQ + d$$

$$a = 0$$

$$b = 0.0108$$

$$c = 0.2236$$

$$d = 0$$

Valid range for Q:

Minimum: 13

Maximum: 44

See section 9.8 "Custom curves" on how to enter a custom curve.

5 Operating the Instrument

5.1 Single shot mode

Typically the major standards recommend to perform a few impacts prior to obtaining the rebound number to check the operation of the hammer. In this mode the results are not saved.



Select Single Shot mode.

Select



Confirm or cancel the action.

Select

5.2 Measurement Series

The number of impacts required for a valid rebound number depends on the statistics method selected, which should be chosen according to the local standard.



Having selected any optional settings required, simply perform an impact to begin.

Impact No. 1

Between impacts: Move to next location on grid. Never impact on the same location twice.

Impact No. 10

Press “Select” button to close the series

Confirm or cancel the action.

Q value Standard Deviation

No. of impacts Impact counter

Tilt for compressive strength estimate defined by the optional settings (Units, conversion curve, combined correction factor resulting from form factor and carbonation settings)

5.3 Delete the last impact (Outlier)

Typically, the major standards require the user to disregard obvious outliers, which may occur when impacting on a large aggregate or over a void. Such outliers may be simply deleted.



Impact number 8 is an outlier.

Select



Delete

Select



Confirm

Select



The counter resets by one and the measurement can be repeated.

5.4 Working with the data list

The last 20 series recorded can be reviewed in the data list. The PC model allows all series stored on the SilverSchmidt to be reviewed on the PC.



Select



Review list

Select



Select Summary for details of the series

Select



Delete

Select

6 Ordering Information

All units are supplied with standard accessories (battery charger with USB-cable, data carrier with software, carrying strip, grinding stone, chalk, documentation) and carrying case

Units

Part No.	Description
341 31 000	SilverSchmidt PC Type N
341 41 000	SilverSchmidt PC Type L
341 30 000	SilverSchmidt ST Type N
341 40 000	SilverSchmidt ST Type L

Parts and Accessories

Part No.	Description
341 10 113	Cover for USB port
341 10 312S	Plunger spring (set of 10)
341 10 315	Plunger SilverSchmidt ST/PC complete
341 10 400	SilverSchmidt anvil
342 10 400	Low range anvil
341 10 395	Upgrade kit for existing Euro anvil
341 80 105	Carrying bag complete
341 80 203	Carrying strap
341 80 211	Grinding stone
341 80 213	SilverSchmidt Upgrade ST to PC, Type N
341 80 214	SilverSchmidt Upgrade ST to PC, Type L
341 89 000	SilverSchmidt Premium Calibration Certificate
341 89 001	SilverSchmidt Anvil Premium Calibration Certificate
341 90 005	Mushroom plunger
351 90 018	USB cable 1.8m

7 Technical Specifications

Impact energy Type N	2.207 Nm (1.63 ft lbf)
Impact energy Type L	0.735 Nm (0.54 ft lbf)
Concrete compressive strength range Types N/L	10 – 100 MPa (1450 – 14500 psi)
Concrete compressive strength range Type L plus mushroom plunger	5 – 30 MPa (725 – 4351 psi)
Dimensions of housing	55 x 55 x 255mm (2.16" x 2.16" x 9.84")
Weight	570 g (1.3 lb)
Max. impacts per series	99
Memory capacity (PC version only)	ca. 400 series of 10 impacts ca. 200 series of 20 impacts
Useful memory capacity ST version	Last 20 series may be reviewed in the data list
Display	17 x 71 pixel, graphic
Battery life	>5000 impacts between charges
Charger connection	USB type B (5V, 100 mA)
Operating temperature	0 to 50°C (32 to 122°F)
Storage temperature	-10 to 70°C (14 to 158°F)
IP classification	IP54

8 Maintenance and Support

Self test function

The instrument performs a number of self test checks and gives an alert when there is a problem.

These three alerts show the battery status:



Low battery

Battery full

Battery charging



Low impact energy: The impact spring is out of tolerance and should be replaced. It is recommended to return the SilverSchmidt to an authorized service centre.

Checking the calibration on the anvil

The SilverSchmidt checks for correct impact energy with each and every impact. Nevertheless it is recommended to check the calibration on a regular basis.

- Set the hammer to single shot mode and perform at least three impacts before taking any readings.
- Perform a series of 10 impacts on the anvil (Part No. 341 10 400)
- Check that the average Q-value lies within the tolerance shown on the label.
- If it is out of tolerance, check for smooth operation of the plunger. This problem can be solved by applying one or two drops, (no more), of light oil (e.g. sewing machine oil). If the plunger is dirty, wipe it with a soft cloth before applying the oil. After applying the oil, turn the plunger a few times and depress it a few times to spread the oil evenly. Wipe off any excess oil before use. If it is still out of tolerance it should be returned to an authorized Proceq Service Center.



NOTE: There is a small spring located inside the plunger. Take care not to lose this when removing the plunger for cleaning. Therefore hold the SilverSchmidt with the plunger downward. Pull out the plunger and remove the spring.

Support Concept

Proceq is committed to providing a complete support service for this instrument by means of our global service and support facilities. It is recommended that the user register the product on www.proceq.com to obtain the latest on available updates and other valuable information.

Standard Warranty and Extended Warranty

The standard warranty covers the electronic portion of the instrument for 24 months and the mechanical portion of the instrument for 6 months. An extended warranty for one, two or three years for the electronic portion of the instrument may be purchased up to 90 days of date of purchase.

9. Starting Hammerlink



Hammerlink_Setup_V_X_X_X
Hammerlink Setup
Proceq SA

Locate the file “Hammerlink_Setup” on your computer or on the CD and click on it. Follow the instructions you see on the screen.

Application settings

The menu item “File – Application settings” allows the user to select the language and the date and time format to be used.

Connecting to the SilverSchmidt



Connect your SilverSchmidt to a free USB port, then click on the icon to bring up the following window:

Choose communication type

Select the communication type

Serial

Choose the interface with which the device is connected to the PC.
Note: - Only communication types supported by the device are displayed.
- USB devices might be shown as serial.

Serial port settings

Find device automatically (Scan ports) or enter COM port number: 6

Ethernet settings

Device IP address: 0 . 0 . 0 . 0

Stop search after first device has been found. Help

< Back Next > Cancel Help

Leave the settings as default or if you know the COM port you can enter it manually.

Click on “Next >”

The USB driver installs a virtual COM port which is used to communicate with the SilverSchmidt. When a SilverSchmidt has been found you will see another window. Click on the “Finish” button to establish the connection.

9.1 Viewing the data

The data stored on your SilverSchmidt will be displayed on the screen:

Impact counter	Name	Date & Time	Mean value	Averaging mode	Upper outliers	Lower outliers	Valid/Total	Std dev.	Conv. curve	Form factor	Carbonation factor
9		02/22/2010 3:44 PM	36.0 MPa	Mean	0	0	10/10	21.0 MPa	Curve EU	100%	1.00
25		02/25/2010 12:00 AM	30.5 N/mm ²	Mean	0	0	10/10	57.3 N/mm ²	Curve EU	100%	1.00
26		02/25/2010 12:00 AM	31.2 Q	Mean 2G2	3	3	10/16	4.6 Q	Curve China	100%	1.00
33		02/22/2010 4:03 PM	26.5 N/mm ²	Mean 3G3	3	3	10/16	20.0 N/mm ²	Curve China	100%	1.00
71		02/22/2010 4:10 PM	30.3 Q	Mean 3G3	3	3	10/16	3.1 Q	Curve China	100%	1.00

- The test series is identified by the “Impact counter” value.
- There is a “Name” column where the user can give his own name to the series.
- The “Date and Time” when the measurement series was made.
- The “Mean value” which is either a Q- value or a compressive strength unit.
- The “Averaging mode” that was selected to perform the measurement series.
- The number of upper and lower outliers.
- The “Valid/Total” number of impacts made in the measurement series.
- The “Std dev.” Standard deviation of the measurement series.
- The “Conv. Curve” conversion curve used for evaluating the measurements.
- The “Form factor” selected.
- The “Carbonation Factor” carbonation correction factor.

Click on the double arrow icon in the impact counter column to see more details:

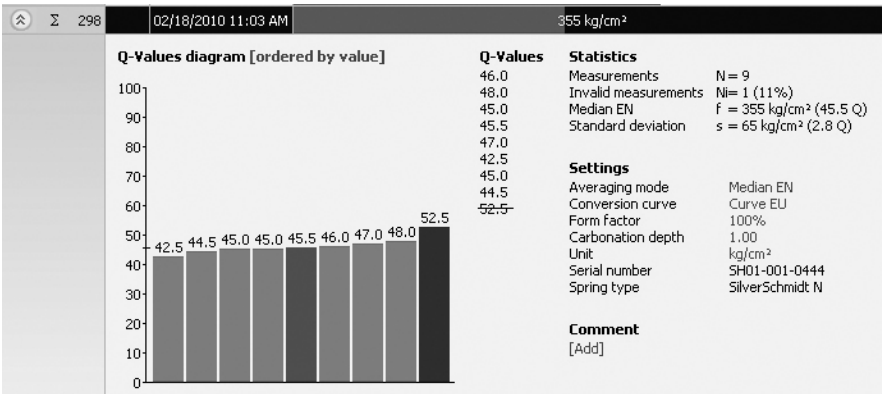

NOTE: The user may also add a comment to the measurement series. To do so, click on “Add”.



NOTE: The user may alter the order in which the measurements are shown. Click on “measurement order” to switch to “ordered by value”.

Summary window

In addition to the “Series” view described above, Hammerlink also provides the user with a “Summary” window. This is useful for uniformity testing to quickly identify areas of inferior quality.

Series		Summary
Impact counter	Name	Date & Time
Σ 277		02/25/2010 6:03 AM

Click on the respective tab to switch between views.



NOTE: To include or exclude a series from the summary, click on the summary symbol in the impact counter column. This symbol is either “black” or “greyed out”, which shows whether or not the series is included in the summary. In order to make a summary, all selected series have to have the same unit. The summary view can be adjusted in a similar way to the detailed view of the series.

9.2 Adjusting the settings

Each of the settings (averaging mode, conversion curve, form factor, carbonation and unit) that were used in the SilverSchmidt at the time of the measurement series can be adjusted subsequently in Hammerlink. This can be done either by right clicking directly on the item in the appropriate column, or by clicking on the blue setting item in the detailed view of a measurement series. In each case a drop down selection box will appear with the choice of setting.

Carbonation factor

Please refer to 4.2.1.

9.3 Adjusting the date and time

The dialog box titled "Adjust time" contains two main sections. The first section, "Current time stamp of series", has two sub-sections: "Date" with a text box containing "02/18/2010" and "Time" with a text box containing "11:02:16 A". An arrow points to the second section, "Time stamp after adjustment", which also has "Date" and "Time" sub-sections. The "Date" sub-section has a dropdown menu showing "02/18/2010" and a small downward arrow. The "Time" sub-section has a text box containing "11:02:16" and a small downward arrow. Below these sections is an "Info" box with the text: "Every selected measurement will be adjusted by the same amount of time". At the bottom right are "Cancel" and "OK" buttons.

Right click in the “Date & Time” column.

The time will be adjusted for the selected series only.

9.4 Exporting data

Hammerlink allows you to export selected series or the entire project for use in third party programs. Click in the table on the particular measurement series you wish to export. It will be highlighted as shown.

Series		Summary									
Impact counter	Name	Date & Time	Mean value	Averaging mode	Upper outliers	Lower outliers	Value/Total	Std dev.	Conv. curve	Form factor	
290		02/18/2010 11:03 AM	65 kg/cm ²	Median LN	0	0	8/9	65 kg/cm ²	Curve EU	100%	
203		02/18/2010 11:02 AM	1450 PSI	Mean AOTM	0	0	10/10	1550 PSI	Curve EU	100%	
274		02/18/2010 11:00 AM	86.7 Q	Mean	0	0	12/12	1.2 Q	Curve EU	100%	
267		02/18/2010 10:59 AM	9.0 N/mm ²	Mean	0	0	9/9	0.5 N/mm ²	Curve EU	100%	



Click on the “Copy as text” icon. The data for this measurement series is copied to the clipboard and can be pasted into another program such as Excel. If you wish to export the actual impact values of the series you have to display them by clicking on the double arrow icon as described above before you “Copy as text”.



Click on the “Copy as picture” icon – For exporting the selected items only into another document or report. This performs the same action as above, but the data is exported in the form of a picture rather than as text data.



“Export as text” icon – Allows you to export the entire project data as a text file that can then be imported into another program such as Excel. Click on the “Export as text” icon. This will open the “Save As” window where you can define the location in which you wish to store the .txt file.



NOTE: Hammerlink has two „tabs“ with two display formats. “Series” and “Summary”. When performing this operation the project data will be exported in the format defined by the active “Tab”, i.e. either in “Series” or “Summary” format.

To open the file in Excel, locate the file and right click on it and “Open with” – “Microsoft Excel”. The data will be opened in an Excel document for further processing. Or drag and drop the file into an open Excel window.



NOTE: Measurement series may be copied between Hammerlink project files by selecting with CTRL-C and pasting using CTRL-V.

9.5 Deleting and restoring data

The menu item “Edit – Delete” allows you to delete one or more selected series from the downloaded data.



NOTE: This does not delete data from the SilverSchmidt, only data in the current project.

The menu item “Edit – Select all”, allows the user to select all series in the project for exporting etc.

Restoring original downloaded data

Select the menu item “File – Restore all original data” to restore the data to the original format as it was downloaded. This is a useful feature if you have been manipulating the data, but wish to go back to the raw data once again. A warning will be given to say that the original data is about to be restored. Confirm to restore.



NOTE: Any names or comments that have been added to series will be lost.

Deleting data stored on the SilverSchmidt

Select the menu item “Device – Delete all Data on Device” to delete all data stored on the Silver-Schmidt.

A warning will be given to say that the data is about to be deleted on the device. Confirm to delete.



NOTE: Please note, this will delete every measurement series. It is not possible to delete individual series.

9.6 Further Functions

The following menu items are available via the icons at the top of the screen:



“Upgrade SilverSchmidt firmware” icon - Allows you to upgrade your firmware via the internet or from local files.



“Open project” icon – Allows you to open a previously saved project. It is also possible to drop a .pqh file onto Hammerlink to open it.



“Save project” icon – Allows you to save the current project. (Note this icon is greyed out if you have opened a previously saved project.



“Print” icon – Allows you to print out the project. You may select in the printer dialog, if you want to print out all of the data or selected readings only.

9.7 Custom statistics

Hammerlink allows you to create a user defined statistics method and to upload this onto the SilverSchmidt.

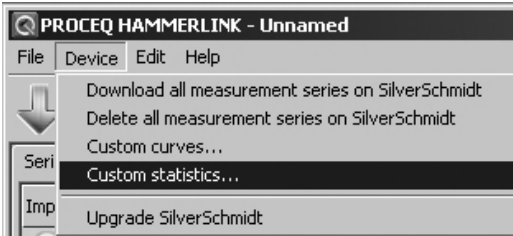

Select the menu item “Custom statistics...” to bring up the following window.

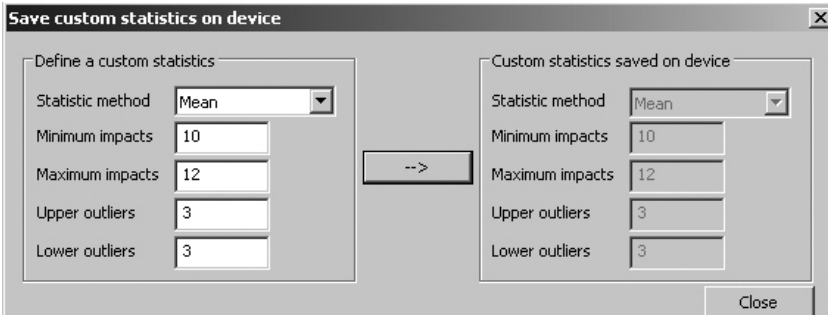

Define the statistics method as desired and load this setting onto the SilverSchmidt by clicking on the arrow in the centre of the window.

Selecting custom statistics on SilverSchmidt

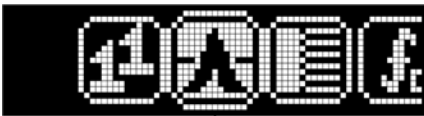

Select “Statistics”

Select

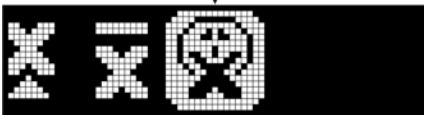

Select “User Preset”

Select

9.8 Custom curves

Hammerlink allows you to create custom curves that are specific to your concrete mix and to upload them onto the SilverSchmidt

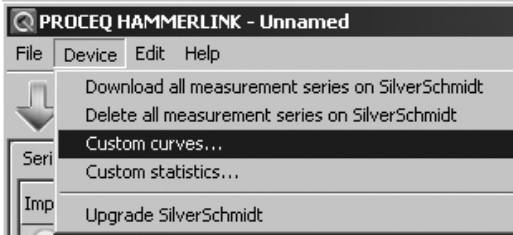

Select the menu item “Custom curves...” to bring up the following window.

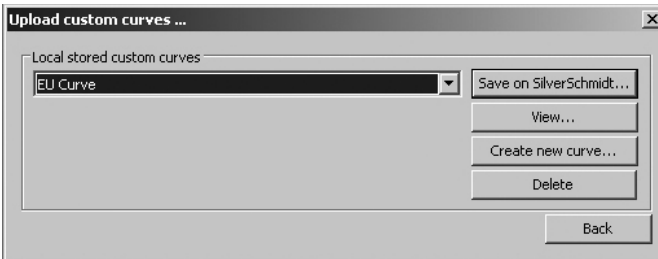

Here you can review custom curves you have previously created, create new curves, delete curves and upload curves on the SilverSchmidt

Click on “Create new curve...” to bring up the following window.

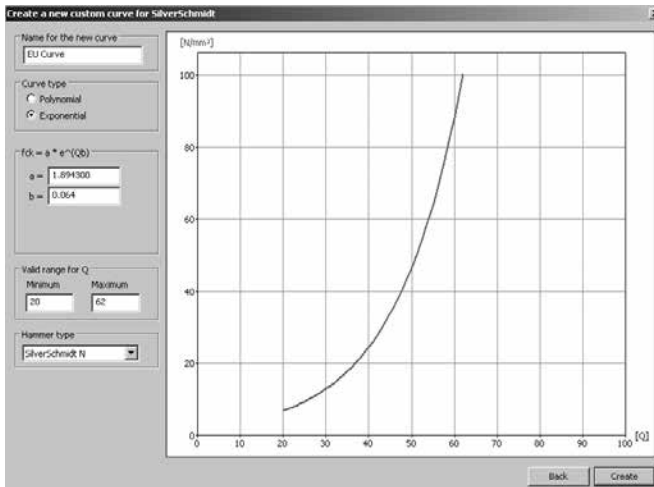

Type in the name for the new curve and enter the parameters and the hammer type (N or L) for which it is applicable.



NOTE: The curve may be exponential or 1st, 2nd or 3rd order polynomial. It is also possible to limit the valid range for the Q-value. Values outside this range will not be evaluated by the SilverSchmidt and this will be indicated on the instrument.

Once you have entered the data, the curve will be displayed.



NOTE: An EXCEL Macro is provided on the product CD to assist in determining the constants for a polynomial curve, based on user data.

Click on “Create” to complete the action.

Uploading the curve onto the SilverSchmidt

From the “Upload customer curves...” window,

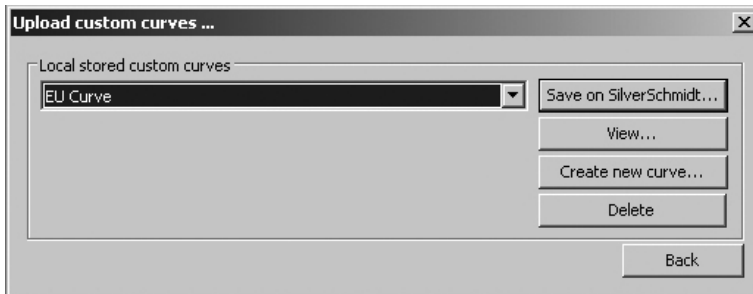

select the curve you have just created and click on “Save on SilverSchmidt...”.

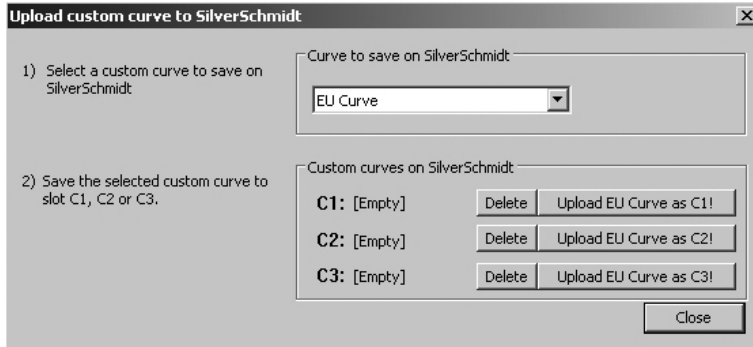

You can store up to 3 custom curves at a time on the SilverSchmidt. Choose the location of the curve (C1, C2 or C3) and upload. A warning window is displayed. Click on "Yes" to complete the action.



NOTE: You may create up to 200 curves which will be available on Hammerlink.

Using the curve on SilverSchmidt

To use the custom curve on your SilverSchmidt:
Click on the icon for conversion curves.



Select "Conversion curves"

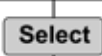

Select "Custom curves"

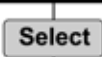

Scroll to select the curve you wish to use and click on the select button.

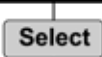

All information contained in this documentation is presented in good faith and believed to be correct. Proceq SA makes no warranties and excludes all liability as to the completeness and/or accuracy of the information.

Notes

.....

.....

.....

.....

.....

.....

.....

.....

.....

.....

.....

.....

.....

.....

.....

.....

.....

.....

.....

.....

.....

.....

Proceq Europe

Ringstrasse 2
8603 Schwerzenbach
Switzerland
Phone +41-43-355-3800
Fax +41-43-355-3812
info-europe@proceq.com

Proceq UK Ltd.

Bedford i-lab, Priory Business Park
Stannard Way
Bedford MK44 3RZ
United Kingdom
Phone +44-12-3483-4515
info-uk@proceq.com

Proceq USA, Inc.

117 Corporation Drive
Alliquippa, PA 15001
U.S.A.
Phone +1-724-512-0330
Fax +1-724-512-0331
info-usa@proceq.com

Proceq Asia Pte Ltd

12 New Industrial Road
#02-02A Morningstar Centre
Singapore 536202
Phone +65-6382-3966
Fax +65-6382-3307
info-asia@proceq.com

Proceq Rus LLC

Ul. Optikov 4
Korp. 2, lit. A, Office 410
197374 St. Petersburg
Russia
Phone/Fax +7-812-448-3500
info-russia@proceq.com

Proceq Middle East

P. O. Box 8365, SAIF Zone,
Sharjah, United Arab Emirates
Phone +971-6-557-8505
Fax +971-6-557-8606
info-middleeast@proceq.com

Proceq SAO Ltd.

South American Operations
Alameda Jaú, 1905, cj 54
Jardim Paulista, São Paulo
Brasilien Cep. 01420-007
Phone +55-11-3083-3889
info-southamerica@proceq.com

Proceq Trading (Shanghai) Co.

Unit B, 19th Floor
Five Continent International Mansion, No. 807
Zhao Jia Bang Road
Shanghai 200032
China
Phone +86-21-6317-7479
Fax +86-21-6317-5015
info-china@proceq.com

www.proceq.com

Subject to change without notice.

Copyright © 06 2014 by Proceq SA, Schwerzenbach
Part number: 820 341 30E

