

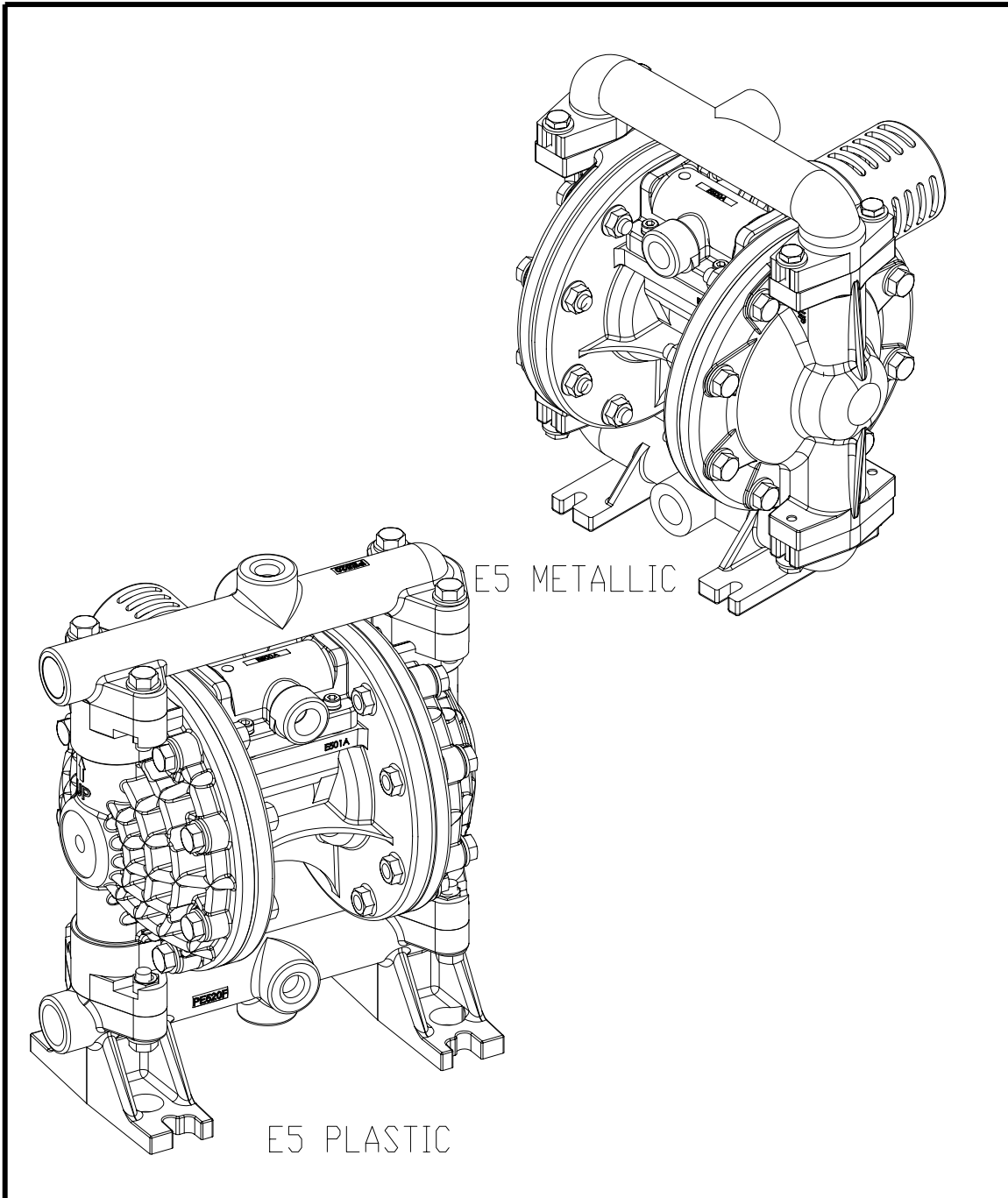

OPERATING INSTRUCTIONS



MODELS

- E5P
- E5K
- E5A
- E5S
- E5H
- BOLTED
- ELIMA-MATIC
- PUMPS

Specifications and Performance

Volumes indicated on chart were determined by actual flow meter tests.

Versa-Matic Model E5 Bolted 1/2" Pump

Flow Rate Adjustable 0-14 gpm
53 lpm)

Port Size:

Inlet & Outlet1/2" NPT

Air inlet.....3/8" NPT

Air Exhaust.....3/8" NPT

Suction Lift20' (6.09m) Dry

.....25' (7.62m) Wet

Teflon5' (3.04m) Dry

.....20' (6.09m) Wet

Max. Particle Dia.....0.625" (1.6 mm)

Shipping Weights

Polypro.....6.795 lbs. (3.08 kg)

SS, Hasteloy.....18 lbs.(8.17 kg)

Aluminum.....15lbs. (6.8 kg)

Kynar.....9.405 lbs. (4.27 kg)

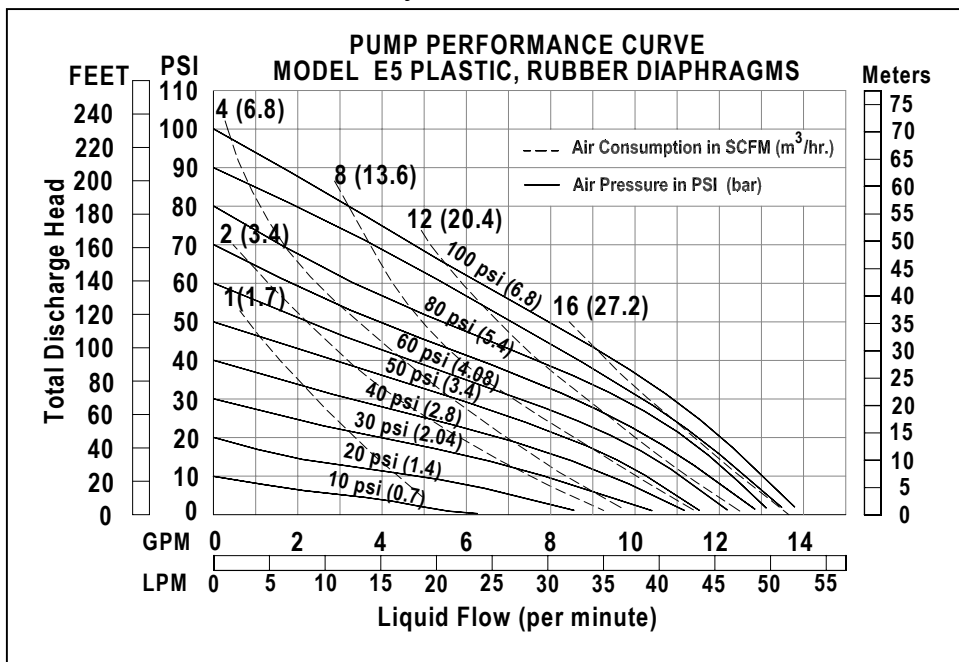

Caution: Do not exceed 100 psig (6.9 bars) liquid or air supply pressure

Teflon is a registered tradename of E.I. DuPont. Kynar is a registered trademark of Penwalt Corp.

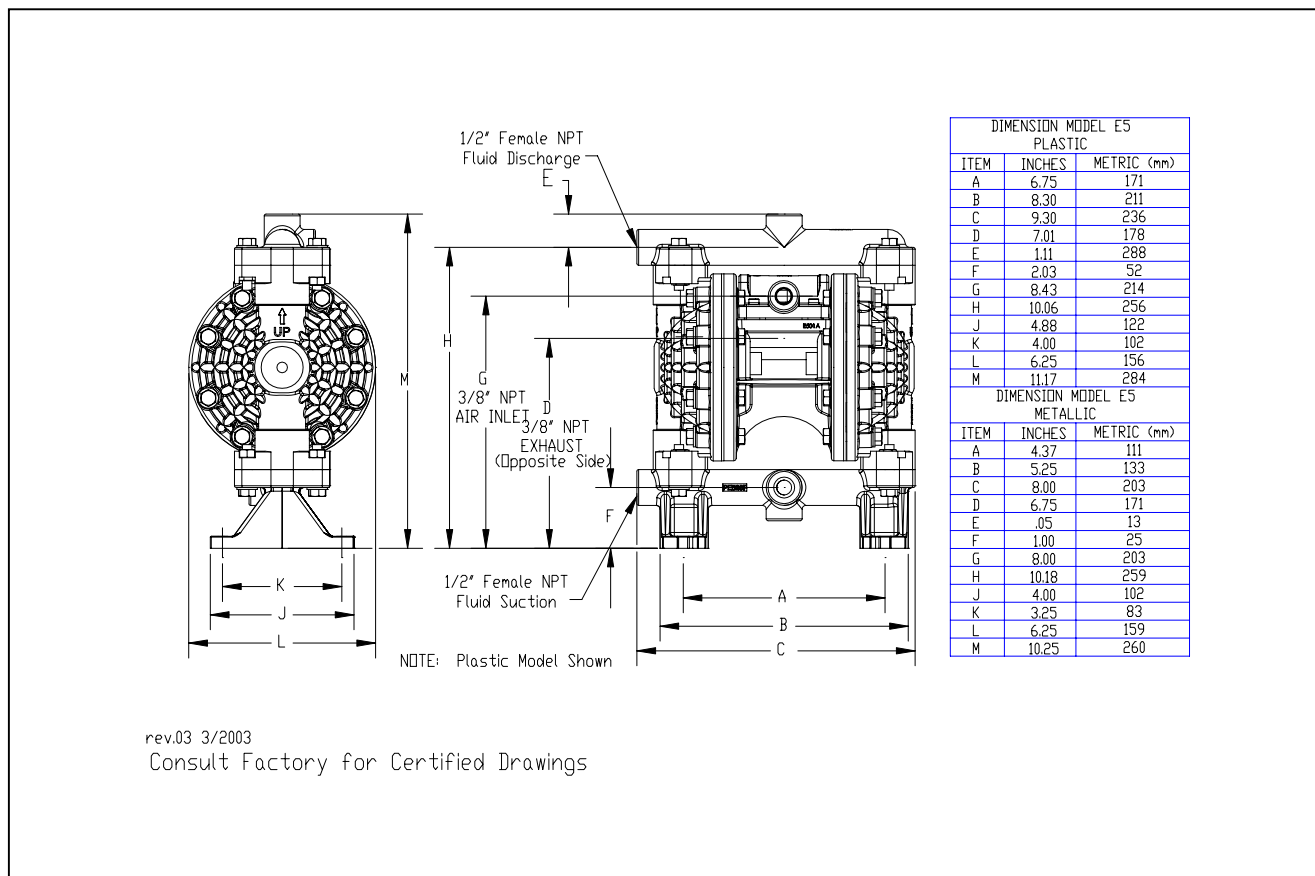

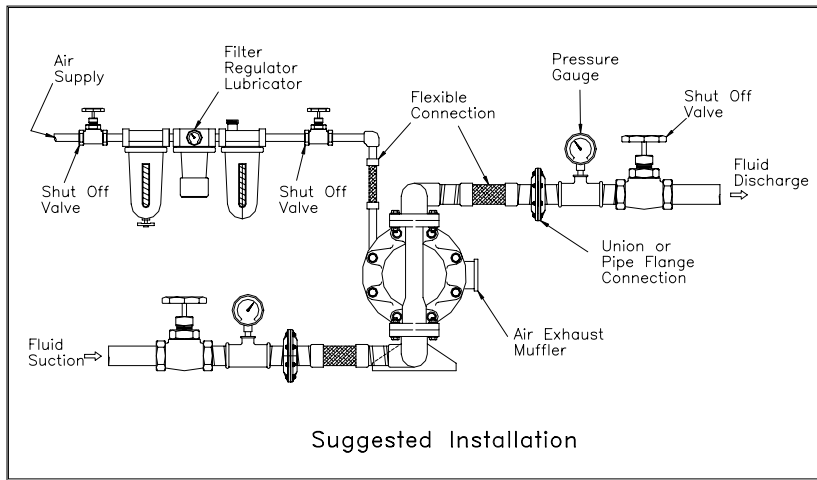

Caution
Do Not Exceed
100 psig air supply
pressure

Installation

The E5 pump comes with a footed base for easy mounting in permanent installations. The pump should be mounted in a vertical position. In permanent installations, the pump should be attached to plant piping using a flexible coupling on both the intake and discharge connections to reduce vibration to the pump and piping. To further reduce vibration, a surge suppresser next to the pump may be used.

Suction pipe size should be at least ½ inch in diameter or even larger if highly viscous fluid is to be pumped. If suction hose is used, it must be of a non-collapsible reinforced type. Discharge piping should be of at least ½ inch. It is critical, especially on the suction side of the pump, that all fittings and connections are airtight or pumping efficiency will be reduced and priming will be difficult.

The air supply line should be at least 3/8-inch diameter. Make certain the supplying line and compressor are capable of supplying the required pressure and volume of air to operate the pump at the desired flow rate. The quality of the compressed air source should be considered. Air that is contaminated with moisture and dirt may result in erratic pump performance and increased maintenance cost as well as frequent process “down time” when the pump fails to operate properly.

Pump Operation

The pump is powered by compressed air. Compressed air is directed to the pump air chamber by the main air valve. The compressed air is separated from the fluid by a membrane called a diaphragm. The diaphragm in turn applies pressure on the fluid and forces it out of the pump discharge. While this is occurring, the opposite air chamber is de-pressurized and exhausted to atmosphere and fluid is drawn into the pump suction. The cycle again repeats, thus creating a constant reciprocating action that maintains flow through the pump. The flow is always in through the bottom suction connection and out through the top discharge connection. Since the air pressure acts directly on the diaphragms, the pressure applied to the fluid roughly approximates the air supply pressure supplied to the main air valve.

Trouble Shooting

The pump will not run, or runs slowly:

1. Check for sticking air valve. Remove air valve from the pump and flush with solvent to remove dirt and debris. Check spool, u-cup, and air valve bore for nicks and scratches. Clean all ports and replace air valve gasket and u-cups.
2. Check pilot shaft and main shaft for scoring and scratches; replace if needed. Replace the pilot shaft and main shaft o-rings if they are worn, flat, or torn.

The pump runs, but little or no material flows:

1. Check for pump cavitation, slow the pump speed down to match the thickness of the material being pumped.
2. Look for sticking ball checks. If the material being pumped is not compatible with the ball material, the elastomer may swell. Replace the balls and seats with a compatible elastomer type. Check valve seats and if worn or damaged replace with new ones.
3. Make sure all the suction line fittings and connections are airtight.

Air bubbles in pump discharge:

1. Look for ruptured diaphragm.
2. Check for suction leaks in pump manifolds and piping.

Material comes out of the pump air exhaust:

1. Inspect the diaphragm for rupture.
2. Check the tightness of the diaphragm plates to the pump shaft.

Safety Warnings

This equipment should only be used by experienced professional mechanics. Observe all safety warnings. Read all safety warnings and operating manuals before using or repairing this Air Operated Diaphragm Pump. (A.O.D. pump)

General Safety

This equipment may generate fluid pressures equal to the air supply pressure. Therefore DO NOT exceed the recommended air supply pressure, 100 psi

ALWAYS wear safety glasses when using power tools to repair this equipment.

When the pumping system contains dangerous fluids wear protective gloves, glasses etc. when working on or around this equipment.

ALWAYS shut off the air supply and disconnect it from the pump before performing maintenance or repair to the pump.

Do Not put your face or body near the pump air exhaust while the pump is operating.

Bleed all pressure from discharge and suction lines before disconnecting the fluid suction or fluid discharge lines from the pump.

DO NOT operate a pump that is leaking, damaged, corroded or otherwise unable to contain the internal fluid pressure.

ALWAYS make sure safety shut off valves, regulators, pressure relief valves, gauges etc. are working properly before starting the pump.

DO NOT pump incompatible fluids through the pump. Consult your distributor or the factory if you are not sure of compatibility of fluids with the castings and elastomers.

Versa-Matic pumps are designed to operate on compressed air. Other compressed gases have not been tested and may be unsafe to use in A.O.D. pumps.

Before starting a pump make certain the discharge point of the piping system is clear and safe and all person have been warned to stand clear.

Equipment Misuse Hazard

General Safety

Any misuse of this equipment such as over pressurization, modifying parts, pumping incompatible chemicals and fluids, using worn or damaged parts or using gasses other than compressed air to power the pump is not recommended. Any of these circumstances could result in splashing or spraying into the eyes, skin or possible serious bodily injury, fire, explosion or property damage.

Over pressurization

Never exceed the operating pressure recommended for the model pump being used.

Noise

Wear Proper Ear protection when working or standing near A.O.D. pumps. IT IS recommended that a Air Exhaust Muffler is used on this equipment at all time.

Installation Hazards

Do not submerge the pump in liquids that are incompatible with the wetted or non-wetted parts of the pump. If installing in a submerged location extend the air exhaust port above the liquid surface with suitable pipe or hose.

Pipe exhaust line to safe location away from people and install a Air Exhaust Muffler.

Pump Diaphragm Failure

A.O.D. pumps utilize an elastomeric membrane to separate the pumping liquid from the air supply. When this membrane ruptures pumping fluid may be expelled from the air exhaust port. Always pipe the air exhaust port to a safe location or suitable container if dangerous or volatile liquids are being pumped.

Installation

Never allow the piping system to be supported by the pump manifolds or valve housing. The manifolds and valve housings are not designed to support any structural weight and failure of the pump may result. The use of flexible piping connections is highly recommended.

Temperature Limits

Do not exceed the recommended operating temperatures of the pump or pump failure may result.

Moving Parts Hazard

The diaphragm plates (sometimes referred to as piston plates) located inside the pump on either side of the main shaft move when air pressure is supplied to the pump. Therefore, Never attempt to operate the pump with the liquid chambers removed. Moving parts inside the pump can pinch or seriously injure your fingers or other body parts.

Fire or Explosion Hazard

Static electricity can be created by the flow of fluid through the pump or by the reciprocating action of A.O.D. pumps. If the pump is not properly grounded, sparking may occur, and the system may become hazardous. Sparks can ignite fumes or vapor and cause an explosion.

If you experience static sparking or even a slight shock when using the pump do not continue to operate the pump until the pump is properly grounded.

Proper Grounding

Pump, Valves, Discharge and supply lines as well as containers must be grounded. These items must be grounded when handling flammable fluids and when static electricity discharge is a hazard.

1. To ground plastic pumps connect a ground wire to all metallic components as well as the air valve body. The ground wire should be connected to a suitable ground location. (figure 1)
2. To ground metallic pumps, connect a ground wire to any accessible point of attachment such as clamp band bolt or mounting base.

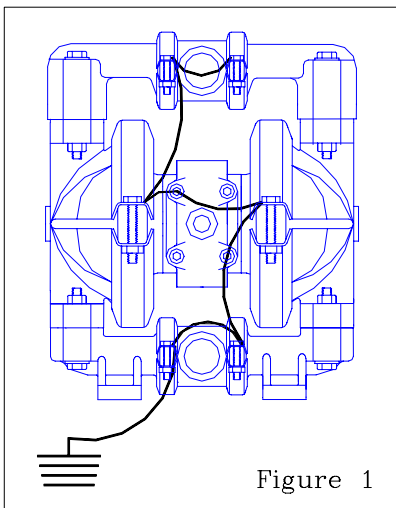

Sound Level Ratings, dB(A)

The following table lists the sound level ratings of Versa-Matic Pumps equipped with factory installed Air Exhaust Mufflers. The readings were obtained with a Pacer Industries model SL-120, sound level indicator "A" scale. Readings were made at a distance of 1 meter from the pump and a height of 1.6 meters above the floor using the factory supplied air exhaust muffler. It is assumed the pumps will be installed at floor level.

Pump series	dB(A) reading
E5, 1/2" pump	78.0 dB(A)

Temperature Limitations

Maximum Temperature limitation are based on mechanical stress only. Certain chemicals will reduce the maximum safe operating temperatures of A.O.D pumps. Consult your dealer or Chemical Resistance guide for compatibility and temperature limits.

Metallic Pumps

Metallic pumps can operate past 212°F (100°C). However if you are operating above these limits, consult the factory for assistance.*

Plastic Pumps

Plastic pumps can operate within the following limits:*

Polypropylene: 32°(0°C) to 175°F(79°C)

PVDF (Kynar): 10°F(-12°C) to 225°F(107°C)

Teflon PFA: -20°F(-29°C) to 200°F(93°C)

*Do not exceed the maximum temperature limits of the elastomer type (diaphragms, balls, seats) that is used in your pump.

Temperature limits of various elastomer types

Neoprene: 0°F(-18°C) to 200°F(93°C)

Buna-N: 10°F(-12°C) to 180°F(82°C)

Nordel: -60°F(-51°C) to 280°F(138°C)

Viton: -40°F(-40°C) to 350°F(176°C)

Teflon: 40°F(4°C) to 220°F(105°C)

Polyurethane: 10°F(-12°C) to 170°F(77°C)

XL TPE: -20°F(-29°C) to 300°F(149°C)

FDA Hytrel: -20°F(-29°C) to 220°F(104°C)

Versa-Matic Pump Company
Model E5 Elima-Matic Pump Parts List

Item	Description	Qty	Plastic			Metallic		
			E5P	E5K	E5G	E5A	E5S	E5H
A1	Air Valve Assembly (items 1-9)	1	E500			E500		
1	Air Valve Body	1	E500A			E500A		
2	Air Valve Spool (includes u-cups)	1	E500B			E500B		
3	Air Valve Spool U-Cup	2	P98-104A			P98-104A		
4	Air Valve End Caps (includes O-rings)	2	E500D			E500D		
5	Air Valve End Cap O-Ring	2	E500E			E500E		
6	End Cap Staple	2	E500F			E500F		
7	Air Valve Diverter	1	E500G			E500G		
8	Air Valve Plate	1	E500H			E500H		
9	Air Valve Gasket - rubberized cork	1	E500J ¹			E500J ¹		
10	Air Valve Cap Screws	4	P24-208			P24-208		
11	Center Section	1	E501A			E501A		
12	Main Shaft	1	E502A			E502A		
13	Main Shaft O-Ring	2	E502B			E502B		
14	Pilot Shaft	1	E503A			E503A		
15	Pilot Shaft O-Rings	6	E503B			E503B		
16	Pilot Shaft Snap Ring	2	E503D			E503D		
17	Pilot Shaft Spacers	5	E503C			E503C		
18	Shaft Retainer	2	E501B			E501B		
19	Shaft Retainer Screws	4	E501C			E501C		
20	Inner Diaphragm Plate	2	V199C			V199C		
21	Outer Diaphragm Plate	2	PV199B	KV199B	CV199B	SV199B	SV199B	HV199B
22	Air Exhaust Muffler	1	VTM-3			VTM-3		
23	Diaphragm	2	E505xx ²			E505xx ²		
24	Water Chamber	2	PE519	KE519	CE519	E504A	E504S	E504H
25	Water Chamber Connecting Bolts	16	SV187A			SV189D		
26	Water Chamber Flange Nuts	16	SV185B			SV185B		
27	Water Chamber Flat Washers	16	SV189C			SV189C		
28	Ball Cage	4	PE522	KE522	CE522	n/a		
29	Valve Seat	4	PE521	KE521	CE521	V110A	SV110	HV110
30	Valve Seat O-Ring	4	N/R			V110xx ⁴		
31	Valve Ball	4	V111xx ³			V111xx ³		
32	Manifold O-Ring	4	E510xx ⁴			n/a		
33	Discharge Manifold	1	PE520	KE520	CE520	V196	SV196	HV196
34	Suction Manifold	1	PE520F	KE520F	CE520F	V197	SV197	HV197
35	Top & Bottom Manifold Connecting Bolt	8	SV189D			SV197F	SV197D	SV197D
36	Top & Bottom Manifold Washers	8	SV189C			SV196C		
37	Top & Bottom Manifold Nuts	8	SV164D			SV197E		

²**Diaphragm Materials**

BN = Buna
 VT = Viton
 TF = Teflon, (E505N, back-up required)
 TX = Teflon, bonded 1 pc.
 XL = TPE XL
 FG = Hytrel
 ND = Nordel
 N = Neoprene, (also used as back-up diaphragm)

³**Valve Ball Material**

BN = Buna
 VT = Viton
 TF = Teflon
 XL = TPE XL
 FG = Hytrel
 SS = Stainless Steel

⁴**O-Ring Material**

BN = Buna
 VT = Viton
 TES = Teflon Encapsulated Silicone
 TEV = Teflon Encapsulated Viton
 HT = VirginTeflon
 XL = TEP XL
 ND = Nordel

REV 6 10/14/03

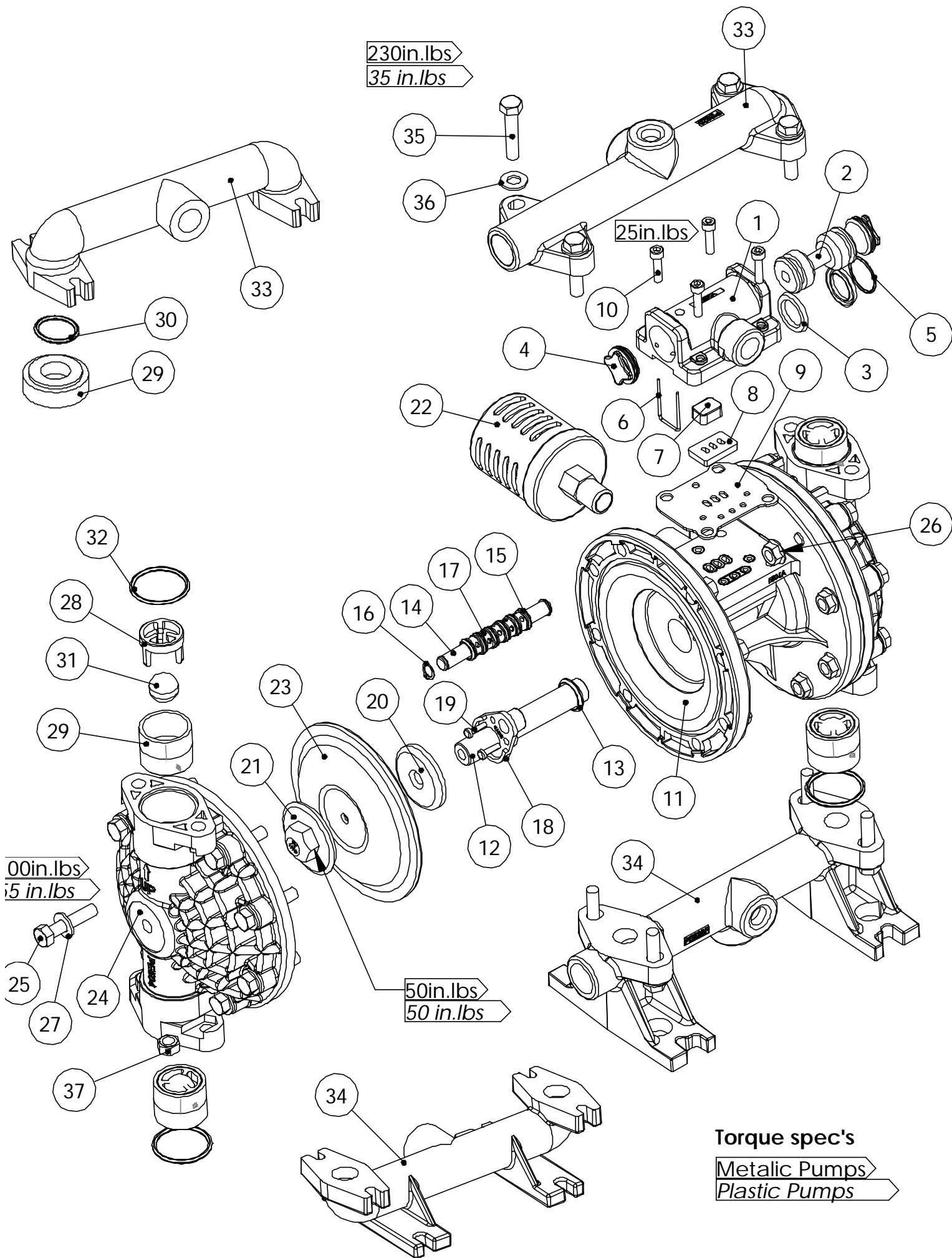

Torque spec's
 Metallic Pumps
 Plastic Pumps

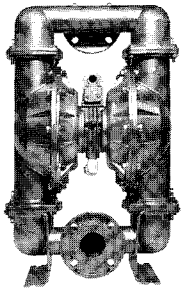

**ELIMA-MATIC®
ANTI-STALLING PUMPS**

- ☐ Virtually eliminates pump stalling caused by air valve system freeze-ups
- ☐ Anti-stalling, non-icing, lubrication-free air valve system.
- ☐ Available in 1/2", 1", 1 1/4", 2" and 3" sizes
- ☐ Wide selection of materials of construction—including 1/2", 1" and 2" plastic models

PLASTIC PUMPS FOR SOLVENTS AND CHEMICALS

- ☐ Exceptional corrosion resistance
- ☐ Wide selection of materials of construction for wetted and non-wetted parts
- ☐ Leak free bolted construction
- ☐ Also available in 1/2", 1", 1 1/2" and 2" with the Elima-Matic anti-stalling air valve system

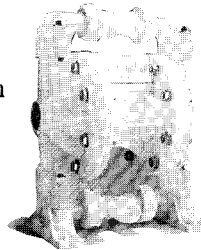

Elima-Matic 2:1 High Pressure Pump

- ☐ Cast in 150lbs ANSI/DIN flanges
- ☐ Constructed of 316 stainless steel
- ☐ Can create discharge pressure over 200 psi
- ☐ Leak-Free bolted design

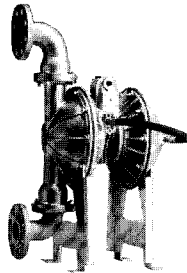

VERSA-DOME® DIAPHRAGMS

- ☐ The simple, smooth design eliminates complex angles allowing for 3 to 4 times the flex life of standard diaphragms.
- ☐ So flexible they can be installed and removed without the use of pry bars
- ☐ Has lower start up pressure than standard diaphragm.
- ☐ Available Neoprene, Buna-N, Hytrel, Nordel®, Viton® and XL.
- ☐ For use in Versa-Matic and Wilden 1/2", 2", 3" pumps.

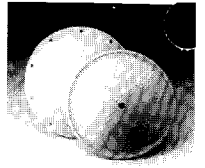

VERSA-TUFF TEFLON DIAPHRAGMS

- ☐ Single piece diaphragm combining the chemical resistance of Teflon with the flex life of rubber.*
- ☐ Three times the burst strength of ordinary Teflon overlays
- ☐ More flexible and 100% bonded to the reinforced rubber backing
- ☐ Diaphragms can be placed into Wilden® M4 and M8 pumps

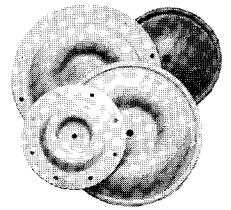

GENUINE VERSA-MATIC REPLACEMENT PARTS AND RETRO FIT CENTER SECTIONS

- ☐ Upgrade V-series and Wilden® M4, M8, and M15 pumps with an Elima-Matic retro fit center section
- ☐ For complete repair of Versa-Matic pumps and Wilden® M4, M8 and M15 metallic pumps
- ☐ Cost-saving elastomer kits for any Versa-Matic pump or Wilden® M1, M2, M4, M8 and M15 pumps
- ☐ Diaphragm and elastomer repair kits available in Buna-N, Neoprene, Nordel®, Teflon®, Viton®, Thermo Plastics Hytrel®, and XL

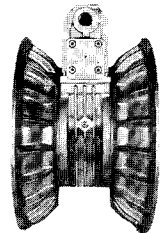

Your local authorized distributor:

FOOD AND SANITARY PUMPS

SANITARY PUMPS

- ☐ FDA approved for use with milk and milk products
- ☐ Constructed of 316 stainless steel
- ☐ Surface finish of 32 micro-inch or better
- ☐ Removable ball cages
- ☐ Easy clean Tri-clamp® connections

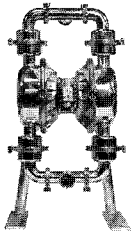

FOOD PROCESSING PUMPS

- ☐ Constructed of 316 stainless steel
- ☐ FDA approved
- ☐ Tri-clamp® connections
- ☐ Over-sized clamp wing nuts for disassembly

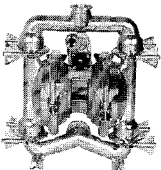

VERSA-MATIC PUMP

6017 Enterprise Drive
Export, PA 15632-8969
(724) 327-7867 • Fax: (724) 327-4300

www.versamatic.com

* Life cycle may vary according to extreme start-up conditions, chemicals and abrasive fluids. To prolong diaphragm life, Versa-Matic recommends a gradual increase in air supply on pump start-up.

Elima-Matic®, Versa-Dome®, Versa-Matic® and VR® are registered trademarks or trademarks of Versa-Matic Tool, Inc. Some Versa-Matic Tool, Inc. products are subject to patent pending applications and issued patents, Elima-Matic U.S. Patent No. 5,326,234. Hytrel®, Nordel®, Teflon® and Viton® are registered trademarks of DuPont. Tri-Clamp® is a registered Trademark of the Tri-Clamp, Inc. Wilden® is a registered Trademark of Wilden Pump and Engineering Co.

