

Panasonic®

Operating Instructions Air Conditioner

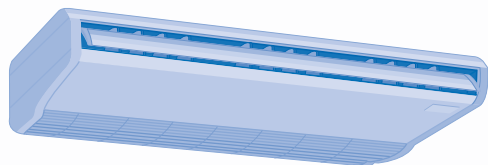

ENGLISH

Before operating the unit, read these operating instructions thoroughly and keep them for future reference.

2 ~ 11

ESPAÑOL

Antes de utilizar la unidad, sírvase leer atentamente estas instrucciones de funcionamiento y conservarlas como futuro elemento de consulta.

12 ~ 21

ITALIANO

Prima di utilizzare l'unità si prega di leggere attentamente le istruzioni e di conservare questo opuscolo per potervi fare riferimento in futuro.

22 ~ 31

DEUTSCH

Bevor Sie das Gerät in Betrieb nehmen, lesen Sie bitte diese Bedienungsanleitung aufmerksam durch und bewahren Sie sie für die künftige Verwendung auf.

32 ~ 41

PORTUGUÊS

Antes de ligar a unidade, leia cuidadosamente este manual de utilização e guarde-o para futura referência.

42 ~ 51

NEDERLANDS

Lees voor u het apparaat gebruikt deze gebruiksinstructies grondig en bewaar ze voor toekomstig gebruik.

52 ~ 61

Indoor Unit

CS-F18DTE5	CS-F34DTE5
CS-F24DTE5	CS-F43DTE5
CS-F28DTE5	CS-F50DTE5

Outdoor Unit

Inverter Model

(HBE5 Series)	(DBE5, DBE8 Series)
CU-YL24HBE5	CU-L24DBE5
CU-YL28HBE5	CU-L28DBE5
CU-YL34HBE5	CU-L34DBE5
CU-YL43HBE5	CU-L43DBE5
(GBE5 Series)	CU-L34DBE8
CU-YL24GBE5	CU-L43DBE8
CU-YL28GBE5	CU-L50DBE8
CU-YL34GBE5	
CU-YL43GBE5	

Heat-pump Model

CU-B18DBE5	CU-B28DBE8
CU-B24DBE5	CU-B34DBE8
CU-B28DBE5	CU-B43DBE8
CU-B34DBE5	CU-B50DBE8

Cooling Model

CU-J18DBE5	CU-J24DBE8
CU-J24DBE5	CU-J28DBE8
CU-J28DBE5	CU-J34DBE8
CU-J34DBE5	CU-J43DBE8
	CU-J50DBE8



QUICK GUIDE / GUÍA RÁPIDA
GUIDA RAPIDA / KURZANLEITUNG
GUIA RÁPIDO / SNELLE GIDS



© 2008 Panasonic HA Air-Conditioning (M) Sdn. Bhd. (11969-T). All rights reserved. Unauthorized copying and distribution is a violation of law.

SAFETY PRECAUTIONS

DEFINITION

The instructions to be followed are classified by the following symbols:



This symbol denotes an action that is **PROHIBITED**.



These symbols denote actions that are **COMPULSORY**.

To prevent personal injury, injury to others, or property damage, please observe the following.

Incorrect operation due to failure to follow instructions may cause harm or damage, the seriousness of which is classified as below:



Warning This sign warns of death or serious injury.



Caution This sign warns of injury or damage to property.

Wireless Remote Control



- Do not use rechargeable (Ni-Cd) batteries.
- Do not allow infants and small children to play with the remote control to prevent them from accidentally swallowing the batteries.



- Remove the batteries if the unit is not going to be used for a long period of time.
- New batteries of the same type must be inserted following the polarity stated to prevent malfunction of the remote control.

Indoor Unit



- Do not install, remove and reinstall the unit by yourself; improper installation will cause leakage, electric shock or fire. Please consult an authorized dealer or specialist for the installation work.
- Do not insert your fingers or other objects into the unit.
- Do not attempt to repair the unit by yourself.

Indoor Unit



- Do not install the unit in a potentially explosive atmosphere.
 - Do not wash the unit with water, benzene, thinner or scouring powder.
 - Do not use for other purposes such as preservation of food.
 - Do not use any combustible equipment in front of the airflow outlet.
 - Do not expose directly to cold air for a long period.
- 
- Ensure that the drainage pipe is connected properly. Otherwise, leakage may occur.
 - Aerate the room regularly.

Power Supply



- Do not share the same power outlet with other equipment.
- Do not modify power cords.
- Do not use extension cords.
- Do not operate with wet hands.



- Use the specified supply cord.
- If the supply cord is damaged, it must be replaced by the manufacturer, its service agent or similarly qualified persons in order to avoid a hazard.



- This equipment must be earthed and strongly recommended to be installed with Earth Leakage Circuit Breaker (ELCB) or Residual Current Device (RCD). Otherwise, it may cause electrical shock or fire in case of malfunction.



- In case of emergency or abnormal conditions (burnt smell, etc), turn off the power supply, and consult your nearest dealer.

Power Supply



- Switch off the power supply before cleaning or servicing.
- Turn off the power supply if the unit is not used for a long period of time.
- This air conditioner is equipped with a built-in surge protective device. However, in order to further protect your air conditioner from being damaged by abnormally strong lightning activity, you may want to disconnect it from the power supply. Do not touch the air conditioner during lightning, it may cause electric shock.

Outdoor Unit



- Do not insert your fingers or other objects into the unit, sharp parts may cause injury.

Outdoor Unit



- Do not sit or step on the unit, you may fall down accidentally.
- Do not touch the sharp aluminum fin, sharp parts may cause injury.



- Ensure that the drainage pipe is connected properly. Otherwise, leakage may occur.
- After long periods of use, make sure the installation rack is not damaged.

REGULATORY INFORMATION

Thank you for purchasing
Panasonic Air Conditioner

This appliance is not intended for use by persons (including children) with reduced physical, sensory or mental capabilities, or lack of experience and knowledge, unless they have been given supervision or instruction concerning use of the appliance by a person responsible for their safety. Children should be supervised to ensure that they do not play with the appliance.

OPERATION CONDITION

Use this air conditioner under the following temperature range

Model	Temperature (°C)		Indoor	Outdoor
Inverter (GBE5, DBE5, DBE8 Series)	COOLING	Maximum	32	43
		Minimum	21	-15*
	HEATING	Maximum	27	24
		Minimum	16	-20
Heat-pump	COOLING	Maximum	32	43
		Minimum	21	-10**
	HEATING	Maximum	27	24
		Minimum	16	-10
Cooling	COOLING	Maximum	32	43
		Minimum	21	-10**

NOTICE: This unit is still able to operate as a cooler with outdoor temperature as low as -15°C*/-10°C** in a non-living room, such as a computer room, with a room temperature of 21°C or above, and room humidity up to 45%.

(CU-YL24HBE5, CU-YL28HBE5, CU-YL34HBE5, CU-YL43HBE5)

Temperature (°C)		Indoor	Outdoor
COOLING	Maximum	32	43
	Minimum	21	-5
HEATING	Maximum	27	24
	Minimum	16	-15

NOTICE: This unit is still able to operate as a cooler with outdoor temperature as low as -5°C in a non-living room, such as a computer room, with a room temperature of 21°C or above, and room humidity up to 45%.

TABLE OF CONTENTS

SAFETY PRECAUTIONS	2
REGULATORY INFORMATION	3
PRODUCT OVERVIEW & OPERATIONS (WIRELESS REMOTE CONTROL)	4-5
PRODUCT OVERVIEW & OPERATIONS (WIRED REMOTE CONTROL)	6-8
CARE & CLEANING	9
TROUBLESHOOTING	10-11
QUICK GUIDE	BACK COVER

NOTE :

The illustrations in this manual are for explanation purposes only and may differ from the actual unit. It is subjected to change without notice for future improvement.

Information for Users on Collection and Disposal of Old Equipment and used Batteries



These symbols on the products, packaging, and/or accompanying documents mean that used electrical and electronic products and batteries should not be mixed with general household waste.

For proper treatment, recovery and recycling of old products and used batteries, please take them to applicable collection points, in accordance with your national legislation and the Directives 2002/96/EC and 2006/66/EC.

By disposing of these products and batteries correctly, you will help to save valuable resources and prevent any potential negative effects on human health and the environment which could otherwise arise from inappropriate waste handling.

For more information about collection and recycling of old products and batteries, please contact your local municipality, your waste disposal service or the point of sale where you purchased the items.

Penalties may be applicable for incorrect disposal of this waste, in accordance with national legislation.



For business users in the European Union

If you wish to discard electrical and electronic equipment, please contact your dealer or supplier for further information.

[Information on Disposal in other Countries outside the European Union]

These symbols are only valid in the European Union. If you wish to discard these items, please contact your local authorities or dealer and ask for the correct method of disposal.



Note for the battery symbol (bottom two symbol examples):

This symbol might be used in combination with a chemical symbol. In this case it complies with the requirement set by the Directive for the chemical involved.

- Do not switch ON the unit when waxing the floor. After waxing, aerate the room properly before operating the unit.
- Do not install the unit in oily and smoky areas.

PRODUCT OVERVIEW & OPERATIONS (WIRELESS REMOTE CONTROL)

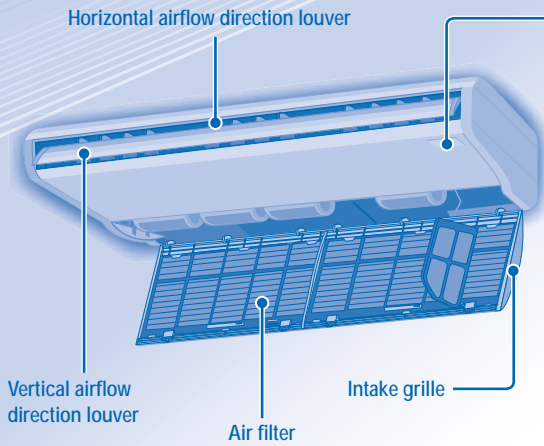

Control Panel

- POWER
- TIMER
- FILTER
- ECONOMY
- ODOUR WASH

Ray receiver

Auto OFF/ON button

- To operate the unit if the wireless remote control is misplaced or malfunctioning.

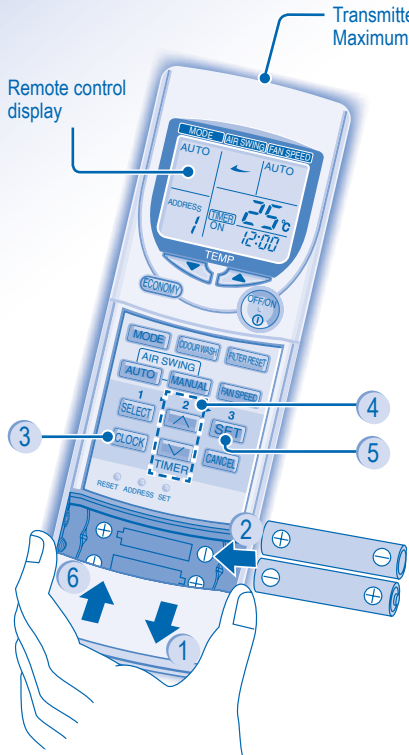

Action	Mode
Press once.	Auto
Press and hold until you hear 1 beep, then release.	Cooling
1. Press and hold until you hear 2 beeps then release. 2. Press the SET button for 5 seconds.	Heating
Press the button to turn off.	



Transmitter
Maximum distances: 8m

Remote Control Preparation

- 1 Press and pull out
- 2 Insert AAA or R03 batteries (can be used ~ 1 year)
- 3 Press CLOCK
- 4 Set time
- 5 Confirm
- 6 Close the cover

TO TURN ON OR OFF THE UNIT



TO SET TEMPERATURE

• Selection range: 16°C ~ 31°C.

TO SELECT OPERATION MODE

AUTO mode - For your convenience

- Unit selects operation mode according to temperature setting, outdoor and room temperature.

HEAT mode - To enjoy warm air

- Unit takes a while to warm up.
(Applicable for Inverter / Heat-pump Model)

FAN mode - To enables air circulation in the room

COOL mode - To enjoy cool air

DRY mode - To dehumidify the environment

- Unit operates at low fan speed to give a gentle cooling operation.
- During soft dry operation, the indoor fan operates at a low fan speed.
- The louvers movement might not align with the remote control display.

Inverter / Heat-pump Model
CZ-RL513T
Cooling Model
CZ-RL013T

FAN SPEED TO SELECT FAN SPEED (3 OPTIONS)

→ AUTO → LOW → MEDIUM → HIGH

- For AUTO, the indoor fan speed is automatically adjusted according to the operation mode.
- If the operation mode is set to Fan, the fan speed will be fixed at MEDIUM regardless of the temperature setting.

AIR SWING TO ADJUST AIRFLOW DIRECTION

AUTO **MANUAL**

- Keeps the room ventilated.

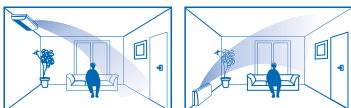
AUTO

- Auto Air Swing function optimize room comfort by giving finer control over the airflow direction.
- The vertical airflow louver swings up and down automatically.
- Do not adjust the vertical airflow direction louvers by hand.
- Horizontal airflow direction louver is manually adjustable.

**MANUAL**

- There are 4 options for manual vertical airflow direction.
- The airflow direction can be adjusted as desired by using remote control.

ECONOMY TO REDUCE POWER CONSUMPTION

- Recommend to use when desired room temperature is reached.
- Economy operation can be activated in all modes and can be cancelled by pressing the respective button again.

ODOUR WASH**ODOUR REMOVING**

- Applicable for all models.
- Helps to remove unpleasant odour from the surrounding area during operation.
- To enable the odour removing function, press the **ODOUR WASH** once.
- To cancel, press the respective button again.

ODOUR CLEAR

- Applicable for Inverter model only.
- To remove odour and minimize the growth of odour causing moulds in the air conditioner's interior section.
- To enable this function, press the **ODOUR WASH** for more than 3 seconds.
- The unit will automatically perform Fan and Heating modes for approximately 20 minutes and then stops automatically.
- Recommended to open the windows during this operation.

TO SET DAILY TIMER

- To turn ON or OFF the unit at a preset time.

1 Select ON or OFF timer.	2 Set the time.	 3 SET Confirm.
---	-------------------------------	--

- To cancel ON or OFF timer, press **CANCEL**.
- When ON timer is set, the unit may start early before the actual set time in order to achieve the desired temperature on time.
- Timer operation is based on the clock set in the remote control and repeats daily once set. For clock setting, please refer to Remote Control preparation.
- The timer closest to the current time will be activated first.
- If timer is cancelled manually, you can restore the previous setting by pressing **SET**.
- If the main power is switched off for an hour or more, the clock and timer will need to be set again.

OPTIONAL SETTINGS

- To avoid unintentional operation, you can assign a different address to each indoor unit.
- Press repeatedly to select your desired address setting.

→ Group → Address 1 → Address 2 → Address 3

ADDRESS

- By default, ADDRESS 1 is selected. You do not need to change this setting for normal operation.
- If the address is set to GROUP, more than one indoor unit can be operated at the same time.

RESET

Press to restore the remote control's default setting.

SET

Not used in normal operations.

HINTS

- Set the temperature 1°C higher in cool mode or 2°C lower in heat mode than the desired temperature to achieve a 10% power saving.
- Use curtains to screen off sunlight and outdoor heat to reduce power consumption during cool mode.

PRODUCT OVERVIEW & OPERATIONS (WIRED REMOTE CONTROL)

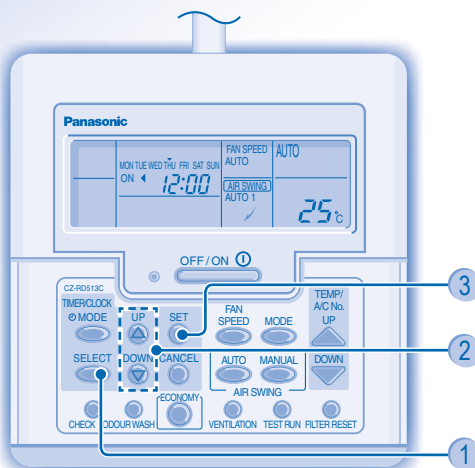
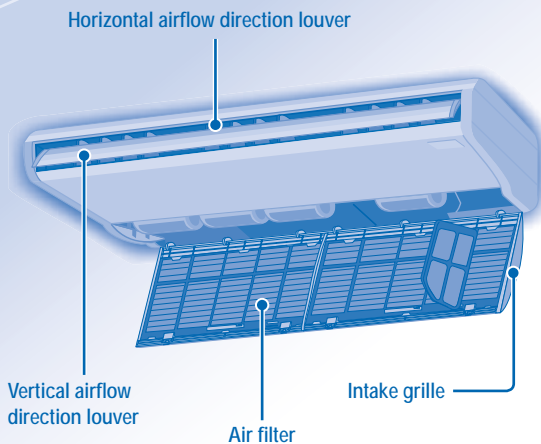

CZ-RD513C

- For normal operation, the and buttons are not in use.

Remote Control Preparation

- 1 Press
- 2 Press to set day
- 3 Confirm
- 4 Repeat steps 2 and 3 to set the current time.

TO TURN ON OR OFF THE UNIT

UP
 DOWN
TO SET TEMPERATURE

- Selection range: 16°C ~ 31°C.

TO SELECT OPERATION MODE

AUTO mode - For your convenience

- Unit selects operation mode according to temperature setting, outdoor and room temperature.

HEAT mode - To enjoy warm air

- Unit takes a while to warm up.
(Applicable for Inverter / Heat-pump Model)

FAN mode - To enables air circulation in the room

COOL mode - To enjoy cool air

DRY mode - To dehumidify the environment

- Unit operates at low fan speed to give a gentle cooling operation.
- During soft dry operation, the indoor fan operates at a low fan speed.
- The louvers movement might not align with the remote control display.



TO SELECT FAN SPEED (3 OPTIONS)



- For AUTO, the indoor fan speed is automatically adjusted according to the operation mode.
- If the operation mode is set to Fan, the fan speed will be fixed at MED regardless of the temperature setting.



TO ADJUST AIRFLOW DIRECTION

- Keeps the room ventilated.

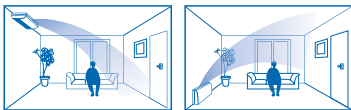

- Auto Air Swing function optimize room comfort by giving finer control over the airflow direction.
- The vertical airflow louver swings up and down automatically.
- Do not adjust the vertical airflow direction louvers by hand.
- Horizontal airflow direction louver is manually adjustable.



- There are 4 options for manual vertical airflow direction.
- The airflow direction can be adjusted as desired by using remote control.



TO REDUCE POWER CONSUMPTION

- Recommend to use when desired room temperature is reached.
- Economy operation can be activated in all modes and can be cancelled by pressing the respective button again.



ODOUR REMOVING

- Applicable for all models.
- Helps to remove unpleasant odour from the surrounding area during operation.
- To enable the odour removing function, press the  once.
- To cancel, press the respective button again.

ODOUR CLEAR

- Applicable for Inverter model only.
- To remove odour and minimize the growth of odour causing moulds in the air conditioner's interior section.
- To enable this function, press the  for more than 3 seconds.
- The unit will automatically perform Fan and Heating modes for approximately 20 minutes and then stops automatically.
- Recommended to open the windows during this operation.

TO SET DAILY TIMER

- To turn ON or OFF the unit at a preset time.

1

MODE



Enter daily timer mode.

2

SELECT



Select ON or OFF timer.

3

UP



DOWN



Set the time.

4

SET



Confirm.

- To cancel ON or OFF timer, press  .

- When ON timer is set, the unit may start early before the actual set time in order to achieve the desired temperature on time.
- Timer operation is based on the clock set in the remote control and repeats daily once set. For clock setting, please refer to Remote Control preparation.
- The timer closest to the current time will be activated first.
- If timer is cancelled manually, you can restore the previous setting by pressing .
- If the main power is switched off for an hour or more, the clock and timer will need to be set again.

HINTS

- Set the temperature 1°C higher in cool mode or 2°C lower in heat mode than the desired temperature to achieve a 10% power saving.
- Use curtains to screen off sunlight and outdoor heat to reduce power consumption during cool mode.

TO SET WEEKLY TIMER

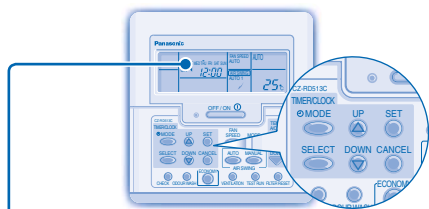

Will light up if Timer operation is selected

6 different programs can be set in a day (1 ~ 6)

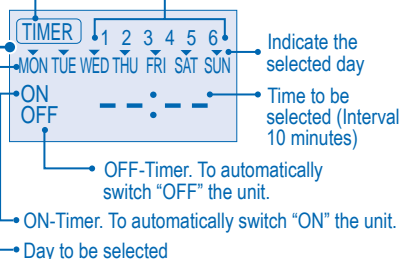

Change Display

1. Press for 3 seconds to change the display to weekly timer.

Select days to run timer

2. Press to enter day setting.
3. Press to select your desired day. The selected day will be highlighted with . Press to deselect or select . Repeat this step includes other day.

Select ON/OFF Timer

4. Press to enter Timer 1.
5. Press to choose ON or OFF.
6. Press to confirm the selection.

Select Timer

7. Press to select your desired time. If you want to set together with your desired temperature, press to select the temperature.
 8. Press to confirm the setting.
- Repeat steps 5 to 8 to set Timer 2 to 6, or press to cancel the related timers.

OPERATION DETAILS

- Weekly timer is only applicable for wired remote control, press for 3 seconds to select daily timer or weekly timer.
- Daily timer and weekly timer could not be set at the same time.
- Promotes energy saving by allowing you to set up to 6 timers in any given day.
- Same timer program cannot be set on the same day.

Check Timer

1. Enter timer mode.
2. Select the day.
3. The display will show the program for each of the selected day.

Modify Or Add Timer

- Perform check timer operation to select the day. Repeat steps 4 to 8 to modify existing timer program, or add any new timer program.

Cancel Timer

- Perform the step below to cancel the timer program for a particular day.

1. Enter timer mode.
2. Select the day.
3. Press to enter day setting.
4. Press to cancel the timer set.

Disable Weekly Timer

- To disable weekly timer setting, press , then press .

Enable Weekly Timer

- To enable previous weekly timer setting, press , then press .

CARE & CLEANING



CAUTION

- Switch off the power supply before cleaning.
- Do not touch the aluminium fin, sharp parts may cause injury.

WASHING INSTRUCTIONS

- Do not use benzene, thinner or scouring powder.
- Use only soap (≈ pH7) or neutral household detergent.
- Do not use water hotter than 40°C.

HINTS

- Clean the filter regularly for best performance and to reduce power consumption.
- Please consult your nearest dealer for seasonal inspection.

Remove Air Filter

- 1 Push the knobs in the intake grille in the direction of the arrow to open the intake grille.

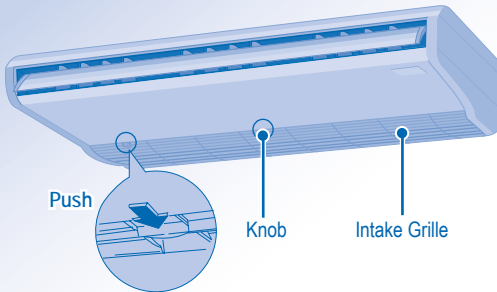

Air Filter Installation

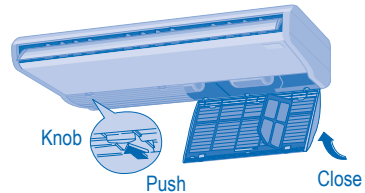

1. Install the air filters to the intake grille by the reverse procedures of removal.
2. Close and push the knobs to secure the intake grille.

- 2 Remove the main air filters from the intake grille tabs.

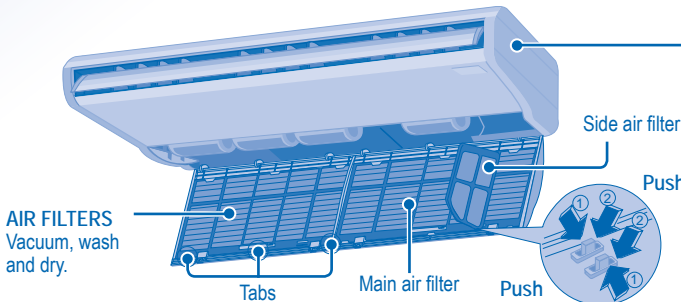

INDOOR UNIT

Wipe the unit gently with a soft, dry cloth.

- 3 Press the side air filter tab ① and ② in that order to release the side air filter.

Air Filter Maintenance

Cleaning is needed when:

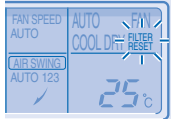

"FILTER RESET" appears on the remote control display. (For wired remote control)

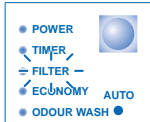

"FILTER" lights up on the indicator display. (For wireless remote control)

- It is recommended to clean the air filter every 6 weeks.
- After the air filter is cleaned, press / to reset.
- Do not operate without an air filter.
- Wash/rinse the air filter gently with water to avoid damage to the air filter surface.
- Do not dry the part with a hair dryer or a stove.
- Replace any damaged air filter.

TROUBLESHOOTING

The following symptoms do not indicate malfunction.

Symptom	Cause
Mist emerges from indoor unit.	<ul style="list-style-type: none"> • Condensation effect due to cooling process.
Water flowing sound during operation.	<ul style="list-style-type: none"> • Refrigerant flow inside the unit.
The room has a peculiar odour.	<ul style="list-style-type: none"> • This may due to damp smell emitted by the wall, carpet, furniture or clothing.
Indoor fan stops occasionally during automatic fan speed setting.	<ul style="list-style-type: none"> • This helps to remove the surrounding odours.
Operation is delayed a few minutes after restart.	<ul style="list-style-type: none"> • The delay is a protection to the unit's compressor.
Outdoor unit emits water/steam.	<ul style="list-style-type: none"> • Condensation or evaporation occurs on pipes.
Timer indicator is always on.	<ul style="list-style-type: none"> • The timer setting repeats daily once set.
Indoor fan stops occasionally during heating operation.	<ul style="list-style-type: none"> • To avoid unintended cooling effect.
Cracking sound can be heard during operation.	<ul style="list-style-type: none"> • Changes of temperature cause the expansion/contraction of the unit.
Unit switch to FAN operation and air become humid.	<ul style="list-style-type: none"> • This happens when the room temperature reaches the set temperature, operation switches to FAN mode and the humidity increase.
Outdoor unit emits noise during heating operation.	<ul style="list-style-type: none"> • This is due to changes inflow of refrigerant gas when operation stops and starts.
Operation does not stop immediately after pressed the OFF/ON button.	<ul style="list-style-type: none"> • Discharging heat is in process. Operation will stops automatically after approximately 60 seconds.
Operation stops occasionally. ("DEFROST" appears on the remote control display)	<ul style="list-style-type: none"> • The unit is in defrosting mode, and the melted frost is drained from the outdoor unit.
Airflow does not start immediately after operation is started. ("PRE HEAT" appears on the remote control display)	<ul style="list-style-type: none"> • The unit is warming up to provide warm air.
Operation starts after power resumes.	<ul style="list-style-type: none"> • Auto restart is in function and operates under previous setting.
During dry mode, cold air blow out.	<ul style="list-style-type: none"> • The unit is running cooling operation with low fan speed to dehumidify the room.
Fan speed change occasionally during heating mode.	<ul style="list-style-type: none"> • The room temperature has reached the remote control setting. When the room temperature drops again, the fan speed will resume to the remote control settings.
Outdoor unit emits steam during heating mode.	<ul style="list-style-type: none"> • This is due to defrost operation happens at the heat exchanger.
Air Swing operation 1, 2, 3 are no variance in angle.	<ul style="list-style-type: none"> • Only one blowing angle is available for Ceiling model.

Check the following before calling for servicing.

Symptom	Check
Heating/Cooling operation is not working efficiently.	<ul style="list-style-type: none"> • Set the temperature correctly. • Close all doors and windows. • Clean or replace the filters. • Clear any obstruction at the air inlet and air outlet vents.
Heating mode cannot be operated.	<ul style="list-style-type: none"> • The unit is forced to operate at cooling mode only in a non-living room, such as a computer room.
Noisy during operation.	<ul style="list-style-type: none"> • Check if the unit has been installed at an incline or the intake grille is not closed properly.
Remote control does not work. (Wireless remote control display is dim or transmission signal is weak.)	<ul style="list-style-type: none"> • Insert the batteries correctly. • Replace weak batteries.
The unit does not work.	<ul style="list-style-type: none"> • Check if the circuit breaker is tripped. • Check if timers have been set.
The unit does not receive the signal from the remote control.	<ul style="list-style-type: none"> • Make sure the receiver not obstructed. • Make sure the address is set correctly. • Make sure the remote control signal transmission is within the range. • Certain fluorescent lights may interfere with signal transmitter. Please consult your nearest dealer.

“CHECK” Display on Wired Remote Control.

If the CHECK indicator flashes on the wired remote control.	<ul style="list-style-type: none"> • Turn off the unit. • Turn on again after 3 minutes. • If CHECK continues to blink, press  for error messages. If problem persist, please consult your nearest authorized dealer.
---	---

FOR SEASONAL INSPECTION AFTER EXTENDED NON-USE

- Checking of remote control batteries (wireless remote control).
- No obstruction at air inlet and air outlet vents.
- After 15 minutes of operation, it is normal to have the following temperature difference between air inlet and air outlet vents:
Cooling: $\geq 8^{\circ}\text{C}$ Heating: $\geq 14^{\circ}\text{C}$

FOR EXTENDED NON-USE

- Activate heat mode (Inverter/Heat-pump model) or Fan mode (Cooling model) for 2~3 hours to remove moisture left in the internal parts thoroughly.
- Turn off the power supply.
- Remove the remote control batteries (wireless remote control).

NON SERVICEABLE CRITERIAS

TURN OFF POWER SUPPLY then CALL Authorized Distributor under the following conditions:

- Abnormal noise during operation.
- Water/foreign particles have entered the remote control.
- Water leaks from Indoor unit.
- Circuit breaker switches off frequently.
- Power cord becomes unnaturally warm.
- Switches or buttons are not functioning properly.
- The odour persists even after odour wash operation is used continuously.

QUICK GUIDE/GUÍA RÁPIDA/GUIDA RAPIDA/ KURZANLEITUNG/GUIA RÁPIDO/SNELLE GIDS

WIRELESS REMOTE CONTROL • CONTROL REMOTO INALÁMBRICO • TELECOMANDO WIRELESS O SENZA FILI •
INFRAROT-FERNBEDIENUNG • CONTROLLO REMOTO SEM FIO • DRAADLOZE AFSTANDSBEDIENING

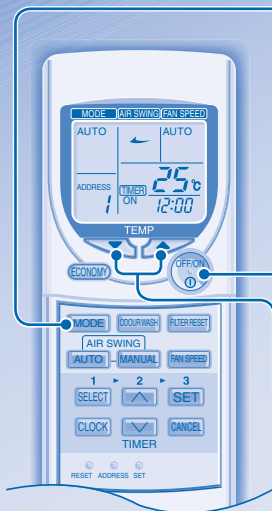

1

MODE

Inverter/Heat-pump
model

↻ AUTO → HEAT
DRY ← COOL ← FAN ↻

Cooling model

↻ AUTO → FAN
DRY ← COOL ↻

Select the desired mode.
Seleccione el modo deseado.
Selezionare la modalità desiderata.
Wählen Sie die gewünschte Betriebsart aus.
Seleccione o modo de funcionamiento pretendido.
Selecteer de gewenste stand.

2



Start/stop the operation.
Inicie/detenga el funcionamiento.
Avviare/arrestare l'apparecchio.
Schalten Sie das Gerät ein bzw. aus.
Ligue/Desligue a unidade.
Start/stop het apparaat.

3



Select the desired temperature.
Seleccione la temperature deseada.
Selezionare la temperatura desiderata.
Stellen Sie die gewünschte Temperatur ein.
Programa a temperatura desejada.
Stel de gewenste temperatuur in.

WIRED REMOTE CONTROL • CONTROL REMOTO CON CABLES • TELECOMANDO CABLATO •
KABELFERNBEDIENUNG • CONTROLLO REMOTO COM FIOS • BEDRADE AFSTANDSBEDIENING

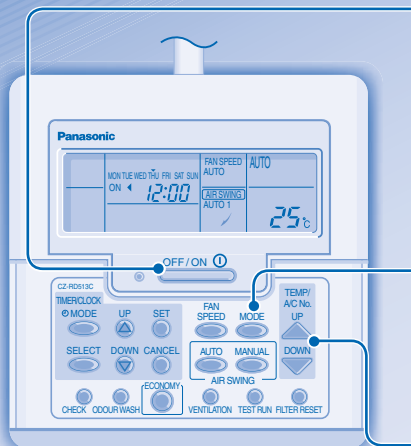

1



Start/stop the operation.
Inicie/detenga el funcionamiento.
Avviare/arrestare l'apparecchio.
Schalten Sie das Gerät ein bzw. aus.
Ligue/Desligue a unidade.
Start/stop het apparaat.

2



Inverter/Heat-pump
model

↻ AUTO → HEAT
DRY ← COOL ← FAN ↻

Cooling model

↻ AUTO → FAN
DRY ← COOL ↻

Select the desired mode.
Seleccione el modo deseado.
Selezionare la modalità desiderata.
Wählen Sie die gewünschte Betriebsart aus.
Seleccione o modo de funcionamiento pretendido.
Selecteer de gewenste stand.

3



Select the desired temperature.
Seleccione la temperature deseada.
Selezionare la temperatura desiderata.
Stellen Sie die gewünschte Temperatur ein.
Programa a temperatura desejada.
Stel de gewenste temperatuur in.

Pursuant to at the directive 2004/108/EC, article 9(2)
Panasonic Testing Centre
Panasonic Service Europe, a division of
Panasonic Marketing Europe GmbH
Winsbergring 15, 22525 Hamburg, F.R. Germany

Panasonic Corporation

Website: <http://panasonic.net/>

Printed in Malaysia
OSTH0806-02