

GB - ENGLISH

Operating Instructions

Dear Customer,

Many thanks for the confidence you have shown in us with the purchase of your new JET-machine. This manual has been prepared for the owner and operators of a JET JTS-315 table saw to promote safety during installation, operation and maintenance procedures. Please read and understand the information contained in these operating instructions and the accompanying documents. To obtain maximum life and efficiency from your machine, and to use the machine safely, read this manual thoroughly and follow instructions carefully.

...Table of Contents

- 1. Declaration of conformity**
- 2. JET Warranty**
- 3. Safety**
 - Authorized use
 - General safety notes
 - Remaining hazards
- 4. Machine specifications**
 - Technical data
 - Noise emission
 - Contents of delivery
 - Description of machine
- 5. Transport and start up**
 - Transport and installation
 - Assembly
 - Dust connection
 - Mains connection
 - Starting operation
- 6. Machine operation**
- 7. Setup and adjustments**
 - Changing saw blade
 - Mounting the raving knife
 - Mounting the saw guard
 - Rising and tilting sawblade
 - Rip fence setup
 - Adjusting 90°stop
 - Adjusting sawblade parallel
- 8. Maintenance and inspection**
- 9. Troubleshooting**
- 10. Available accessories**
- 11. „Safe operation” appendix A**

1. Declaration of conformity

On our own responsibility we hereby declare that this product complies with the regulations* listed on page 2. Designed in consideration with the standards**. CE type examination*** conducted by****.

2. JET Group Warranty

The JET Group makes every effort to assure that its products meet high quality and durability standards and warrants to the original retail consumer/purchaser of our products that each product be free from defects in materials and workmanship as follows:

2 YEARS ON ALL MECHANICAL PARTS

1 YEAR ON ALL ELECTRICAL PARTS:

This Warranty does not apply to defects due to directly or indirectly misuse, abuse, negligence or accidents, normal wear-and-tear, repair or alterations outside our facilities, or to a lack of maintenance.

The Jet group limits all implied warranties to the period specified above, from the date the product was purchased at retail.

To take advantage of this warranty, the product or part must be returned for examination, postage prepaid, to an authorized repair station designated by our office. Proof of purchase date and an explanation of the complaint must accompany the merchandise.

If our inspection discloses a defect, we will either repair or replace the product, or refund the purchase price if we cannot readily and quickly provide a repair or replacement, if you are willing to accept a refund.

We will return repaired product or replacement at JET'S expense, but if it is determined there is no defect, or that the defect resulted from causes not within the scope of JET'S warranty, then the user must bear the cost of storing and returning the product.

The JET Group reserves the right to make alterations to parts, fittings, and accessory equipment which they may deem necessary for any reason whatsoever.

3. Safety

3.1 Authorized use

This machine is designed for sawing wood, wood derived materials as well as similar to be machined hard plastics only.

Machining of other materials is not permitted and may be carried out in specific cases only after consulting with the manufacturer.

No metal workpieces may be machined.

Do not cut round stock without suitable jigs or fixtures. The rotating saw blade could turn the work-piece.

The proper use also includes compliance with the operating and maintenance instructions given in this manual.

The machine must be operated only by persons familiar with its operation, maintenance and repair and who are familiar with its hazards.

The required minimum age must be observed

The machine must only be used in a technically perfect condition. When working on the machine, all safety mechanisms and covers must be mounted.

In addition to the safety requirements contained in this operating instructions and your country's applicable regulations, you should observe the generally recognized technical rules concerning the operation of woodworking machines.

Any other use exceeds authorization. In the event of unauthorized use of the machine, the manufacturer renounces all liability and the responsibility is transferred exclusively to the operator.

3.2 General safety notes

Woodworking machines can be dangerous if not used properly. Therefore the appropriate general technical rules as well as the following notes must be observed.

Read and understand the entire instruction manual before attempting assembly or operation.

Keep this operating instruction close by the machine, protected from dirt and humidity, and pass it over to the

new owner if you part with the tool.

No changes to the machine may be made.

Daily inspect the function and existence of the safety appliances before you start the machine. Do not attempt operation in this case, protect the machine by unplugging the mains cord.

Remove all loose clothing and confine long hair.

Before operating the machine, remove tie, rings, watches, other jewellery, and roll up sleeves above the elbows.

Wear safety shoes; never wear leisure shoes or sandals. Always wear the approved working outfit

Always wear ear protection when operating a table saw.

Do **not** wear gloves while operating this machine.

For the safe handling of sawblades wear work gloves.

Observe the chapter "safe operation" in this manual.

Check the correct rotation of the sawblade before operating the machine.

Do not start cutting operation until sawblade is at full speed.

Control the stopping time of the machine, it may not be longer than 10 seconds.

Do not use side pressure to stop rotating blade.

Insure that the work piece does not roll when cutting round pieces.

Use suitable table extensions and supporting aids for difficult to handle workpieces.

Always hold and guide the workpieces safely during machining.

Pay particular attention to instructions on reducing the risk of kickback.

The supplied raving knife must always be used. Adjust the space to the sawblade to be max 5mm.

Do not perform any operation for which the tool has not been designed for, e.g. do not use this table saw to cut logs or firewood.

Do not perform any operation freehand.

Never reach around or over the saw blade.

When ripping narrow workpieces

(smaller than 120mm) use as push-stick or push-wood.

Push stick or push wood must stay with the machine when tool is stored and not in use.

Always use the mitre gauge for cutting off.

The use of dado-blades and groove cutters is not permissible.

Make sure that small cut off workpieces will not be caught and thrown away by the rising saw blade teeth.

Remove cut and jammed workpieces only when motor is turned off and the machine is at a complete standstill.

Install the machine so that there is sufficient space for safe operation and work piece handling.

Keep the inside of the cabinet clear of sawdust and wood chips. Make sure the motor fan and fan cover are kept clear of sawdust.

Keep work area well lighted.

The machine is designed to operate in closed rooms and must be placed stable on firm and levelled ground.

Make sure that the power cord does not impede work and cause people to trip.

Never use the power cord to carry the tool.

Do not expose the power cord to heat, oil or any sharp corners. Do not pull the cord to unplug.

If the tool is used outdoor, make sure that the extension cord is rated for outdoor use.

Keep the floor around the machine clean and free of scrap material, oil and grease.

Stay alert!
Give your work undivided attention. Use common sense.

Pull the mains plug if the tool is not in use.

Pull the mains plug prior to any maintenance or change of accessory (e.g. sawblade).

Before starting the machine make sure that operating and measuring tools are removed from the machine.

Do not operate the machine when you are tired.

Do not operate the machine under the influence of drugs, alcohol or any medication. Be aware that medication can change your behaviour.

Keep children and visitors a safe distance from the work area.

Never reach into the machine while it is operating or running down.

Never leave a running machine unattended. Before you leave the workplace switch off the machine.

Do not operate the electric tool near inflammable liquids or gases. Observe the fire fighting and fire alert options, for example the fire extinguisher operation and place.

Do not use the machine in a damp environment and do not expose it to rain.

Wood dust is explosive and can also represent a risk to health.

Dust from some tropical woods in particular, and from hardwoods like beach and oak, is classified as a carcinogenic substance. Always use a suitable dust extraction device

Before machining, remove any nails and other foreign bodies from the work piece.

Specifications regarding the maximum or minimum size of the work piece must be observed.

Cut thin or thin-walled work-piece only with fine-toothed saw blades.

Never cut several work-pieces at the same time – and also no bundles containing several individual pieces. Risk of personal injury if individual pieces are caught by the saw blade uncontrolled.

When cutting round stock, use a suitable jig to prevent the work-piece from turning.

Never cut work-pieces containing the following materials:
-Ropes, strings, cords, cables and wires.

Do not force the power tool. It will do a better and safer job and give you much better service if it is used at the rate for which it was designed.

Do not remove chips and work piece parts until the machine is at a complete standstill.

Never operate with the guards not in place – serious risk of injury!

Connection and repair work on the electrical installation may be carried out by a qualified electrician only.

Always unwind any extension cords fully.

Have a damaged or worn cord replaced immediately.

Do not use the machine when the ON-OFF switch does not operate correctly.

The use of accessories other than those recommended in this manual can create a safety hazard.

Make all machine adjustments or maintenance with the machine unplugged from the power source.

When installing a new sawblade make sure that it matches the raving knife.

The raving knife thickness must be in between sawblade body thickness and width of cut.

Make sure that the sawblade is suitable for the work piece material to be cut.

Use only sawblades according to EN 847-1

Never use sawblades made from High Speed Steel (HSS).

Remove defective sawblades immediately.

A worn table insert must be replaced.

3.3 Remaining hazards

When using the machine according to regulations some remaining hazards may still exist

The moving sawblade in the work area can cause injury.

Broken saw blades can cause injuries.

Thrown workpieces can lead to injury

Wood chips and sawdust can be health hazards. Be sure to wear personal protection gear such as safety goggles ear- and dust protection.

Use a suitable dust exhaust system.

The use of incorrect mains supply or a damaged power cord can lead to injuries caused by electricity.

4. Machine specifications

4.1 Technical data

Machine Table	550x800 mm
Rear table extensions	550x800 mm
Sawblade diameter	315 mm
Blade bore diameter	30 mm
Blade body thickness	1,8-2,2 mm
Raving knife thickness	2,3 mm
Blade speed	2800 rpm
Cutting height & 90°/45°	max90/60mm
Tilting range of blade	90°- 47°
Dust port diameter	100 mm
Working height	800 mm
Weight	50 kg

Mains	230V ~1/N/PE 50Hz
Motor input power	1600W S1-100%
Reference current	7,0 A
Extension cord (H07RN-F)	3x1,5mm ²
Installation fuse protection	16A
Isolation class	I

Mains	400V ~3L/PE 50Hz
Motor input power	2000W S1-100%
Reference current	3,5 A
Extension cord (H07RN-F)	4x1,5mm ²
Installation fuse protection	16A
Isolation class	I

4.2 Noise emission

Determined according to EN 1807:1999 (Inspection tolerance 4 dB)

Work piece plywood 16mm:

Acoustic power level (acc. EN 3746):	
Idling	99,6 dB (A)
Operating	104,8 dB (A)

Acoustic pressure level (EN 11202):	
Idling	86,7 dB (A)
Operating	95,5 dB (A)

The specified values are emission levels and are not necessarily to be seen as safe operating levels

This information is intended to allow the user to make a better estimation of the hazards and risks involved.

4.3 Content of delivery

Machine stand
Rear table extension
Rip fence
Sawblade dia 315 mm
Raving knife
Saw guard
Dust connection hose and Y-adapter
2 Wheels
2 Carry handles
Push stick
Operating tools
Operating manual
Spare parts list

4.4 Description of machine

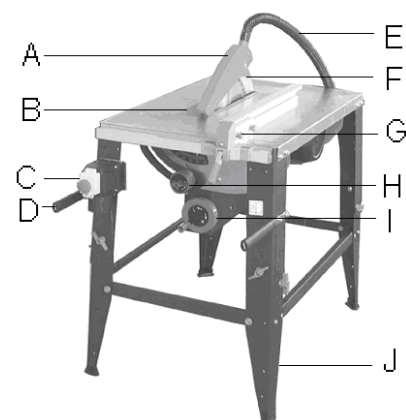

Fig 1

- A.....Saw guard
- B.....Table insert
- C....On/Off switch
- D.....Carry handle
- E..... Dust connection hose
- F..... Raving knife
- G..... Rip fence
- H.... Tilting handle
- I.... Blade rising handle
- J.....Foldable leg stand

5. Transport and start up

5.1 Transport and installation

Never lift the tool on it's guards.

The sawblade must be covered by the saw guard during transport.

The machine is designed to operate in dry rooms and must be placed stable on firm and levelled ground. The machine can be bolted down if required.

For packing reasons the machine is not completely assembled.

WARNING:

To avoid injury, if any parts are missing, do not attempt to assemble the machine, do not plug in the power cord, do not turn the switch on until the missing parts are obtained and installed correctly.

5.2 Assembly

Assemble tool in strict accordance with these instructions. Only if you follow the instructions exactly does the machine conform to the safety

regulations and can be safely operated.

If you notice any transport damage while unpacking, notify your supplier immediately. Do not operate the machine!

Dispose of the packing in an environmentally friendly manner.

Clean all rust protected surfaces with a mild solvent.

Requirements for machine assembly:

- Philips screwdriver
- 22mm wrench
- 17mm wrench
- 10mm wrench
- 8mm wrench
- pair of work gloves

Stand assembly:

The four legs have been folded before shipment.

To assemble the stand:

- unfold the four legs (J, Fig 2) and tighten the nuts securely.
- insert the short crossbeams and tighten the nuts.

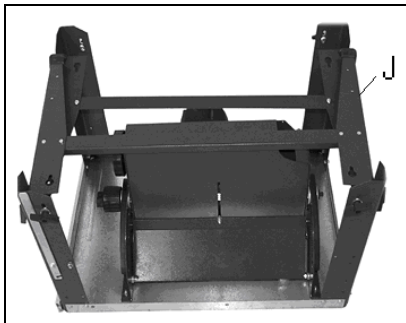

Fig 2

- insert the short crossbeams (Fig 3) and tighten the nuts



Fig 3

NOTE: The carriage bolts (L, Fig 4) must be positioned in the groove to fasten through wing nut.

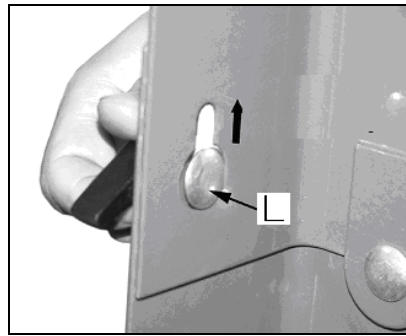

Fig 4

Install dust port:

Attach the dust port with 3 tapping screws (M, Fig 5).

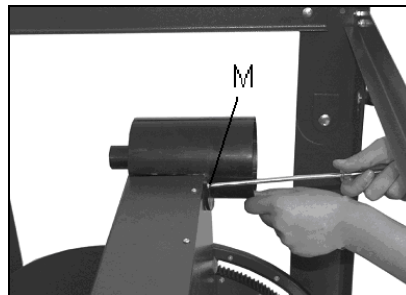

Fig 5

Install switch:

Fit the switch (C, Fig 6) on the left front leg, using two M4 self-locking nuts and two M4X60 screws.

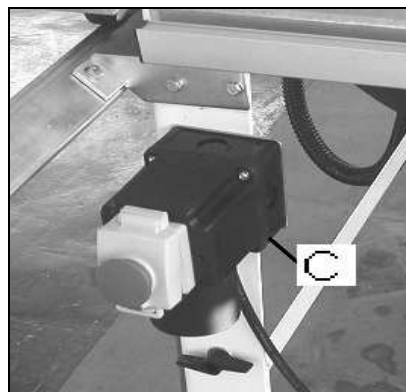

Fig 6

Install saw blade:

See chapter 7.1

Install raving knife:

See chapter 7.2

Install table insert:

Position the table insert into the Table top, and lock with 6 screws.

Install blade guard:

See chapter 7.3

Install rip fence carrier:

Attach the rip fence carrier to the machine table front with
-2 Carriage bolts M6X20
- 2 Nuts M6

Install rip fence:

Use 2 bolts and wing nuts (W, Fig 7)

to attach the aluminium profile (G) to the rip fence body

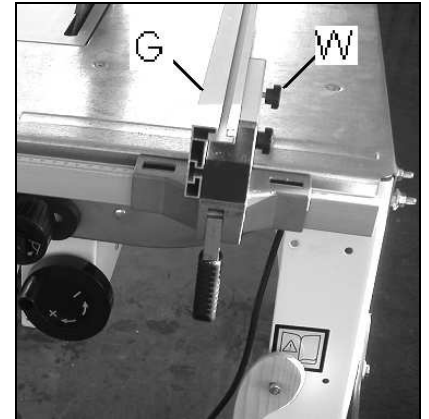

Fig 7

Install rear extension table:

Fit the rear table extension (X, Fig 8).

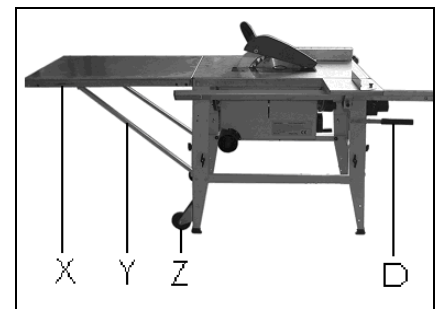

Fig 8



Fig 9

Attach two support arms (Y, Fig 10). Adjust the table to be level and tighten the nuts.

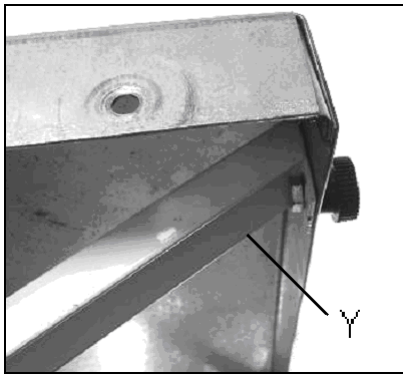

Fig 10

Install wheels:

Attach the wheels (X, Fig 11) with 4 bolts and nuts.

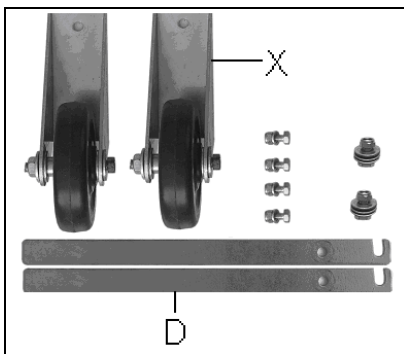

Fig 11

Install carry handles:

Attach the carry handles (D, Fig 11) with 2 bolts to the front legs.

5.3 Dust connection

Before initial operation, the machine must be connected to a dust extractor. The suction should switch on automatically when the saw is switched on.

Attach the connecting hose to the saw guard and the Y-piece

A 100mm dust collection hose can be connected.

5.4 Mains connection

Mains connection and any extension cords used must comply with applicable regulations.

The mains voltage must comply with the information on the machine licence plate.

The mains connection must have a 16A surge-proof fuse.

Only use connection cables marked H07RN-F

Connections and repairs to the

electrical equipment may only be carried out by qualified electricians.

5.5 Starting operation

You can start the machine with the green ON button. The red OFF-button on the main switch (C, Fig 1) stops the machine.

In case of machine overload the motor overload cut-off will react. After appr. 10 min of cooling the machine can be started again.

6. Machine operation

Correct working position:

In front of the machine standing out of the line of cutting (danger zone).

Work piece handling:

Hands placed flat on the work piece outside the cutting area.

Feed the work piece towards the saw blade in the direction of the saw line. Push the work piece steadily forward; complete the cut as a single movement.

Support long and wide workpieces with helping roller stands.

Operating hints:

Always observe the safety instructions and adhere to the current regulations.

Ensure that the saw blade protective cover is in the correct position before you start sawing.

The cutting blade must first reach the maximum rpm before cutting may begin.

Attention:

The condition of the blade should be checked before each machining process. Work only with a sharp and flawless sawblade.

Never use a sawblade rated with a blade speed lower than the machine.

Use a suitable wedge to prevent round timber from turning under the pressure of the cut

Use suitable table extensions and supporting aids for difficult to handle workpieces.

Always hold and guide the workpieces safely during machining.

Do not perform any operation

freehand.

Do not perform any grooving, tenoning or splitting operations on this machine.

When ripping narrow workpieces (width less than 120mm) use a push-stick (Fig 12) or push-wood.

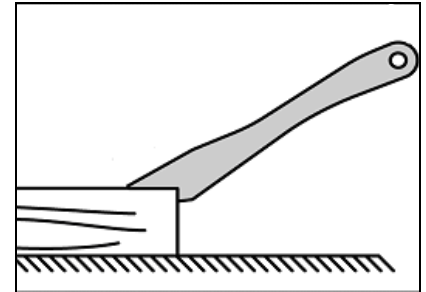

Fig 12

Make sure that small cut off workpieces will not be caught and thrown away by the rising saw blade teeth.

Remove cut and jammed workpieces only when motor is turned off and the machine is at a complete standstill.

Pay particular attention on reducing the risk of kickback.

The supplied raving knife must always be used. Inspect for correct adjustments.

For the authorized use of the machine observe the appendix A "safe operation" (on the last pages of this operating manual)

(on the last pages of this operating manual)

A.1.: Ripping

A.2.: Ripping of narrow stock

A.3.: Crosscutting on rip fence

A.4.: Mitre cutting

A.5.: Ripping of big board

7. Setup and adjustments

General note:

Setup and adjustment work may only be carried out after the machine is protected against accidental starting by pulling the mains plug.

7.1 Changing sawblade

The sawblade has to meet the technical specification.

Use only sawblades according to EN 847-1

Check sawblade for flaws (cracks, broken teeth, bending) before installation. Do not use faulty sawblades.

The sawblade teeth must point in cutting direction (down)

Always wear suitable gloves when handling sawblades.

WARNING:

When installing or changing saw blade, always disconnect saw from power source, unplug!

Remove the saw guard (A, Fig 1)) and table insert (B).

Raise sawblade fully.

Loosen the arbor nut while stopping the arbor against rotation with the supplied tools (S, T, Fig 13)

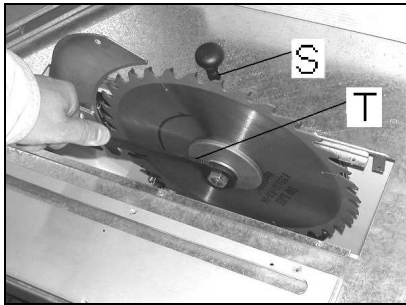

Fig 13

Attention: left hand thread.

Remove the arbor nut (R, Fig 14 and flange (Q).

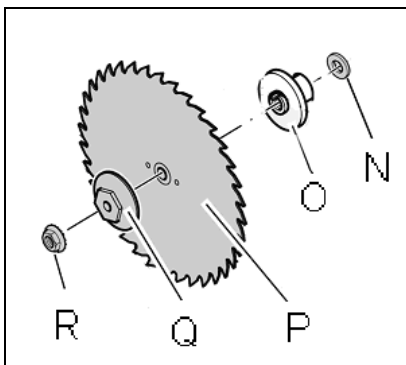

Fig 14

Place saw blade (P) on arbor shaft making sure teeth point down at the front of the saw.

Reinstall flange and arbor nut and securely tighten.

Order for installation:

-adjusting washer (N)

-centring flange (O)

-saw blade (P)

-tightening flange (Q)

-left handed nut (R)

Reinstall the table insert and the saw guard.

7.2 Mounting the raving knife

The supplied raving knife must always be used.

Disconnect saw from power source, unplug!

The raving knife (F, Fig 15) is clamped with 1 nut (U).

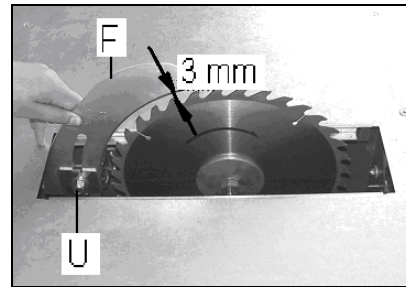

Fig 15

Adjust the space between sawblade teeth and raving knife to be 2 to 5mm.

Well tighten the locking nut (U).

7.3 Mounting the saw guard

The saw guard must always be used.

Attach the saw guard (A, Fig 16) to the raving knife (F) with 1 carriage bolt, washer and wing nut

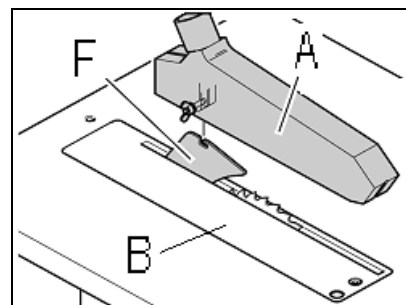

Fig 16

The saw guard must be lowered to the work piece to minimise the amount of exposed teeth.

7.4 Rising and tilting of sawblade

Setup adjustments of the sawblade shall never be performed when the machine is running.

Use the front handle (I, Fig 1) to raise the sawblade.

Use the tilting handle (H, Fig 1) to tilt the sawblade. Tighten knob to lock in place.

Start the machine with care.

7.5 Rip fence setup

Rip fence setup shall never be performed when the machine is running.

Use 2 bots and wing nuts (W, Fig 17) to attach the aluminium profile (G) to the rip fence body

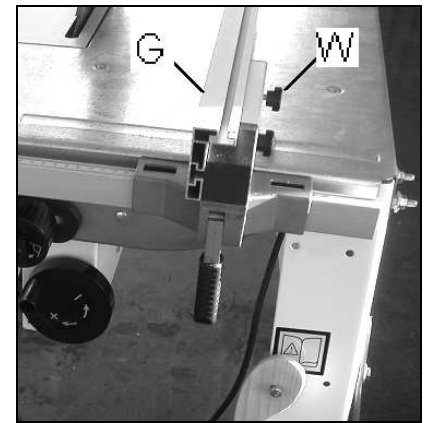

Fig 17

Note:

The rip fence profile can be placed flat and adjusted in length.

-Use in upright position (Fig 17) for cutting wide stock:

-The cutting of small workpieces (width less than 120mm) and tilted cuts shall only be performed with the rip fence profile placed flat (Fig 18).

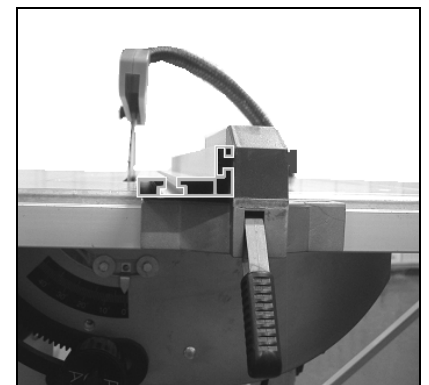

Fig 18

Start the machine with care.

7.6 Adjusting 90° stop

The positive stop is adjusted at the factory.

If out of alignment:

Disconnect saw from the power source, unplug.

Readjust the positive 90° stop.

7.7 Adjusting sawblade parallel

The sawblade is adjusted parallel to the machine table at the factory.

If out of alignment:

Disconnect saw from the power source, unplug.

Loosen the screws on the tabletop (V, Fig 19) and readjust saw unit.

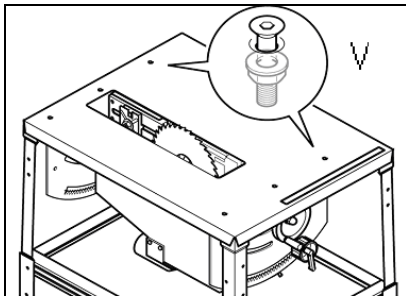

Fig 19

8. Maintenance and inspection

General notes:

Maintenance, cleaning and repair work may only be carried out after the machine is protected against accidental starting by pulling the mains plug.

Repair and maintenance work on the electrical system may only be carried out by a qualified electrician.

Consult a qualified repair shop if a malfunction or damage occurs to this tool, including sawblades and guards.

Cleaning:

Clean the machine regularly.

Inspect the proper function of the dust extraction daily.

Keep the inside of the cabinet clear of sawdust and wood chips.

All protective and safety devices must be re-attached immediately after completed cleaning, repair and maintenance work.

Defective safety devices must be replaced immediately.

Saw blades:

The servicing of saw blades should

only be performed by a trained person.

Defective safety devices must be replaced immediately.

Check saw blades regularly for faults. Replace a defective sawblades immediately.

9. Trouble shooting

Motor doesn't start

*No electricity-
check mains and fuse.

*Defective switch, motor or cord-
consult an electrician.

*Overload has reacted-
Wait and start again.

Machine vibrates excessively

*Stand on uneven floor-
adjust stand for even support.

*dust on saw flanges-
clean saw arbor and flanges.

*defective sawblade -
replace sawblade immediately

Cut is not accurately square

*90° stop not adjusted correctly-
check with square and adjust stop.

Material binds blade when ripping

*Rip fence not parallel to sawblade-
check and adjust rip fence.

*Wrapped wood-
select another piece of wood.

*Excessive feedrate-
reduce feedrate.

Material kicked back from blade

*Fence not aligned with sawblade-
check and adjust rip fence.

*Raving knife not in place-
high danger, mount immediately with guard.

Cutting surfaces is bad

*Wrong sawblade used

*Blade mounted backwards

*resin collection on sawblade

*sawblade is dull

*work piece inhomogeneous

*Feed pressure too high-

Do not force the work piece.

10. Available accessories

(A, Fig 20) Stock No.: 1000811

Right table extension 550 x 800mm including rip fence base extension.

(B, Fig 20) Stock No.: 1000812

Sliding table 230 x 230mm including

mitre gauge.



Fig 20

Refer to the JET-Pricelist for various saw blades.

11. Safe operation

See appendix A (on the last pages of this operating manual)

A.1.: Ripping

A.2.: Ripping of narrow stock

A.3.: Crosscutting on rip fence

A.4.: Mitre cutting

A.5.: Ripping of big board