

Davey® Repair or Replacement Guarantee

In the unlikely event in Australia or New Zealand that this Davey product develops any malfunction within two years of the date of original purchase due to faulty materials or manufacture, Davey will at our option repair or replace it for you free of charge, subject to the conditions below.

Should you experience any difficulties with your Davey product, we suggest in the first instance that you contact the Davey Dealer from which you purchased the Davey product. Alternatively you can phone our Customer Service line on 1300 367 866 in Australia, or 0800 654 333 in New Zealand, or send a written letter to Davey at the address listed below. On receipt of your claim, Davey will seek to resolve your difficulties or, if the product is faulty or defective, advise you on how to have your Davey product repaired, obtain a replacement or a refund.

Your Davey Two Year Guarantee naturally does not cover normal wear or tear, replacement of product consumables (i.e. mechanical seals, bearings or capacitors), loss or damage resulting from misuse or negligent handling, improper use for which the product was not designed or advertised, failure to properly follow the provided installation and operating instructions, failure to carry out maintenance, corrosive or abrasive water or other liquid, lightning or high voltage spikes, or unauthorized persons attempting repairs. Where applicable, your Davey product must only be connected to the voltage shown on the nameplate.

Your Davey Two Year Guarantee does not cover freight or any other costs incurred in making a claim. Please retain your receipt as proof of purchase; you **MUST** provide evidence of the date of original purchase when claiming under the Davey Two Year Guarantee.

Davey shall not be liable for any loss of profits or any consequential, indirect or special loss, damage or injury of any kind whatsoever arising directly or indirectly from Davey products. This limitation does not apply to any liability of Davey for failure to comply with a consumer guarantee applicable to your Davey product under the Australian or New Zealand legislation and does not affect any rights or remedies that may be available to you under the Australian or New Zealand Consumer Legislation.

In Australia, you are entitled to a replacement or refund for a major failure and for compensation for any other reasonably foreseeable loss or damage. You are also entitled to have the goods repaired or replaced if the goods fail to be of acceptable quality and the failure does not amount to a major failure.

Should your Davey product require repair or service after the guarantee period; contact your nearest Davey Dealer or phone the Davey Customer Service Centre on the number listed below.

For a complete list of Davey Dealers visit our website (davey.com.au) or call:

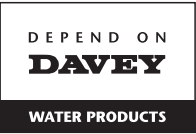
| | | |
|---|---|--|
|  | AUSTRALIA | NEW ZEALAND |
| | Customer Service Centre 6 Lakeview Drive, Scoresby, Australia 3179 Ph: 1300 367 866 Fax: 1300 369 119 Website: davey.com.au | Customer Service Centre 7 Rockridge Avenue, Penrose, Auckland 1061 Ph: 0800 654 333 Fax: 09 527 7654 Website: daveynz.co.nz |

Davey Water Products Pty Ltd
Member of the GUD Group
ABN 18 066 327 517

© Davey & Torrium2 are registered trade marks of Davey Water Products Pty Ltd.
© Davey Water Products Pty Ltd 2011.

P/N 400280-11 supersedes P/N 400280-10

* Installation and operating instructions are included with the product when purchased new. They may also be found on our website.

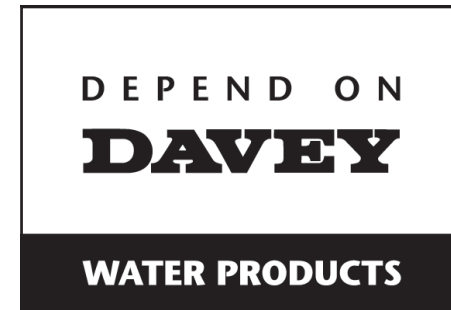

Installation and Operating Instructions for Davey XP/T & XJ/T Pressure Systems with

DAVEY TORRIUM²



NOTE: Prior to installation remove the inlet and outlet pipe transport plugs & associated seals from the suction and/or discharge ports.



WARNING : The Torrium² controller, pump and associated pipework operate under pressure. Under no circumstances should the Torrium² controller, pump or associated pipework be disassembled unless the internal pressure of the unit has been relieved. Failure to observe this warning will expose persons to the possibility of personal injury and may also result in damage to the pump, pipework or other property.



WARNING: Failure to follow these instructions and comply with all applicable codes may cause serious bodily injury and/or property damage.

Please pass these instructions on to the operator of this equipment.

NOTE: The Torrium2® controller fitted to this pump is adaptive. If your pump draws air or is subject to blockage, the Torrium2 adapts to its new maximum pressure. This may result in your system pressure not dropping below the new cut-in pressure and your pump not starting. Should this occur, re-prime your pump units as detailed above. Should this not prove successful, it is likely you have a blockage in the pump. You should contact your Davey dealer for assistance.

NOTE: The Torrium2® controller is adaptive. If your pump draws air or is subject to blockage, the Torrium2® adapts to its new maximum pressure. This may result in your system pressure not dropping below the new cut-in pressure and your pump not starting. This is more likely to occur when boosting mains pressure. Should this occur, re-prime your pump unit. Should this not prove successful, it is likely you have a blockage in the pump. You should contact your Davey dealer for assistance.

NOTE:

- For protection, the Davey® pump motor is fitted with an automatic “over temperature” cut-out. Constant tripping of this overload device indicates a problem e.g. low voltage at pump, excessive ambient temperature (above 50°C) in pump enclosure.
- The Torrium2® control device may have to be reset after rectifying any of the above operating troubles. This is done by pushing in the “prime” button and releasing it after 2 seconds, or switching the power supply off then on.

WARNING: When servicing or attending pump, always ensure power is switched off and lead unplugged. Electrical connections should be serviced only by qualified persons. If the electrical supply lead of this pressure system is damaged, it must be replaced.

Care should also be taken when servicing or disassembling pump to avoid possible injury from pressurised water. Unplug pump, relieve pressure by opening a tap on the discharge side of the pump and allow any hot water in the pump to cool before attempting to dismantle.

During servicing, use only approved, non-petrochemical based oring and gasket lubrication. If unsure, consult your Davey Dealer for advice.

WARNING: Do not use hydrocarbon based or hydrocarbon propelled sprays around the electrical components of this pump.

In accordance with AS/NZS 60335.2.41 we are obliged to inform you that this pump is not to be used by children or infirm persons and must not be used as a toy by children.

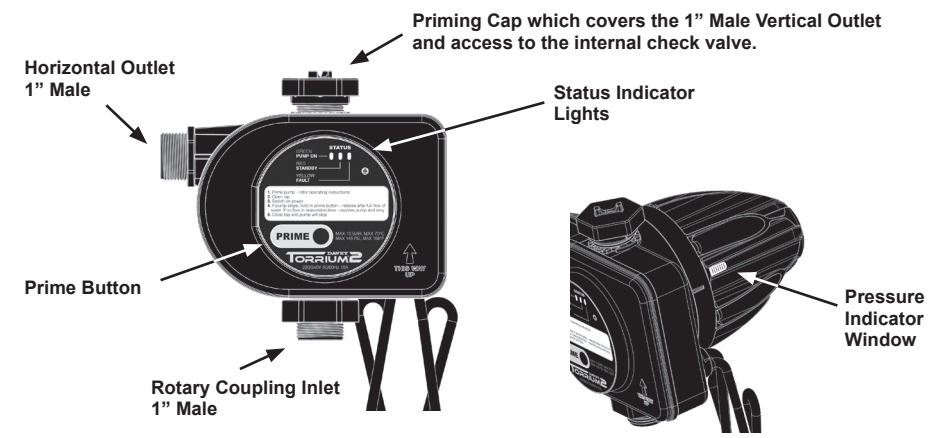

Fitting the Torrium2® directly to the Pump

The Torrium2® is fitted with a rotary coupling. This coupling allows the pump controller to be fitted simply and easily to the pump discharge.

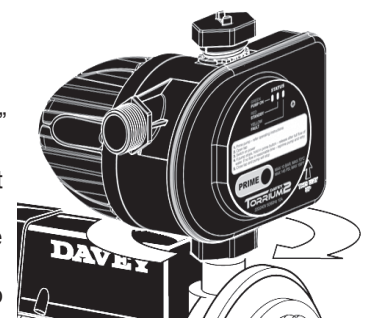

Inside the bag containing these instructions is a 1" (FxF) socket and some thread tape. Wrap thread tape around both pump outlet and Torrium2® inlet and connect the controller to the pump with the socket. The controller adaptor nut is able to rotate independent of the Torrium2® and the complete pump, this allows it to be tightened onto the pump easily. For ease of installation a tightening tool is included with Torrium2® to tighten the controller nut to ensure a firm connection to your controller.

The ability to rotate the adaptor nut also means that the complete controller, once fitted to the pump, can be rotated a full 360° in the horizontal plane, without causing the coupling to unscrew from the pump outlet.

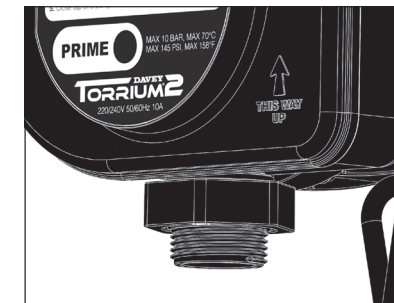

WARNING: With Torrium2® you can connect the discharge pipework to the discharge port and/or the vertical priming port. The priming port is able to be used as a discharge port.

Pressure Indicator Window

Torrium has an easy to read pressure indicator window on the side of the inbuilt pressure vessel – see Figure 1 on page 3.

If the pressure is low the window will show mainly red. If the pressure is at maximum (i.e. 450kPa for TT45 and 700kPa for TT70 models) the window will show mainly green.

The window can also help analyse the occurrence of unwanted leaks. If the colour band in the window is moving towards red, this shows that pressure is decreasing. If the colour band in the window is moving towards green, this shows that pressure is increasing.

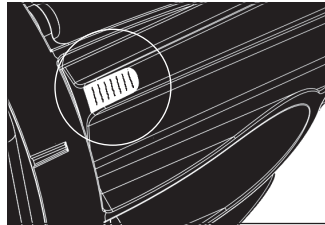

Discharge Connections

The Torrium2® offers the option of using one or both outlet options. Use of the horizontal outlet only allows for either:

1. Easy access to prime the pump and / or the removal of the inbuilt Torrium check valve
2. Fitment of a pressure tank (up to 20 litre capacity) onto the priming port / vertical discharge port

If you use the vertical outlet instead or as well, you need to consider access to the inbuilt check valve in the Torrium. Davey suggest you use a flexible connection and / or union connection to allow for ease of access to the check valve.

Choosing a Site

Choose a site with a firm base and as close to the water source as possible with correct power supply. Make sure your pressure system is always connected to an adequate, reliable source of clean water.

Housing your Davey Pressure System

To protect your pressure system from the weather, make sure the pump house is both water proof, frost free and has adequate ventilation. The pump should be horizontally mounted on a firm base allowing for drainage, to avoid damage to flooring etc., that over time may occur from leaking pipe joints or pump seals. Do not mount the pump vertically.

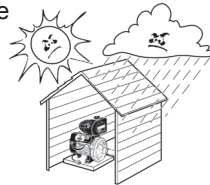

Maintenance



WARNING : Under no circumstances should Torrium2® controller be disassembled. Failure to observe this warning will expose persons to the possibility of personal injury and may also result in damage to other property. Do not dismantle, no user serviceable parts, spring under pressure.

The only regular attention your new pressure system may require will be if you have used an additional pressure tank. Depending on the tank used you may need to check the pressure tank's air charge every 6 months. Follow the instructions applicable to each tank.

Trouble Shooting Check List

- a) **PUMP HAS STOPPED OR MOTOR RUNS FOR SHORT PERIOD ONLY WHEN SWITCHED ON OR PRIME BUTTON PUSHED, BUT DOES NOT PUMP - YELLOW STATUS INDICATOR LIGHT ILLUMINATED.**
 1. Suction line and pump body not filled with water.
 2. Air leaks in suction lines or suction pipe not under water.
 3. Air trapped in suction lines (also possible with flooded suction due to uneven rise in piping; eliminate humps and hollows).
 4. No water at source or water level too low.
 5. Valve on suction lines closed. Open valve & pump will restart automatically or press "Prime" button.
- b) **PUMP SWITCHES ON AND OFF FREQUENTLY (CYCLING)**
 1. Cycling may occasionally be caused by float valves filling tanks.
 2. Leaking taps, float valves etc. check plumbing.
 3. Leaking check valve/foot valve.
- c) **MOTOR DOESN'T START WHEN SWITCHED ON - INDICATOR LIGHTS NOT ILLUMINATED**
 1. Power not connected or no power available from supply outlet.



WARNING: Automatic reset thermal overloads may allow the pump to restart without warning. Always disconnect the pump motor from the electrical supply before maintenance or repairs.



WARNING: When servicing or attending pump and/or controllers, always ensure power is switched off and lead unplugged. Electrical connections should be serviced only by qualified persons.

- d) **MOTOR STOPS - YELLOW STATUS INDICATOR LIGHT IS ILLUMINATED.**
 1. Motor "over temperature" cut-out tripped. Consult Davey dealer.
 2. Motor not free to turn - e.g. a jammed impeller. Consult Davey dealer.
 3. Prime button has been held in for too long. Release prime button and switch off power for 1 minute to allow unit to reset.
 4. Your Torrium2® has detected high water temperature in the pump. Once the water has cooled the Torrium2® will automatically restart the pump.
- e) **PUMP WILL NOT STOP**
 1. Water leaks on discharge side of pump.
- f) **PUMP WILL OPERATE NORMALLY INITIALLY BUT WILL NOT RESTART ON WATER DEMAND - STATUS INDICATOR LIGHT NOT ILLUMINATED**
 1. Power supply problem - see c) 1.
- g) **PUMP WILL OPERATE NORMALLY INITIALLY BUT WILL NOT RESTART ON WATER DEMAND - YELLOW STATUS INDICATOR LIGHT IS ILLUMINATED.**
 1. Suction air leak - pump has partially lost prime.
 2. Blocked impellers or suction.
 3. Discharge valve closed - open valve.



WARNING: Some insects, such as small ants, find electrical devices attractive for various reasons. If your pump enclosure is susceptible to insect infestation you should implement a suitable pest control plan.

For Automatic Pressure Pumps Installed with a Mains Pressure Hot Water System

To protect your system from damage caused by back pressure from hot water systems. You should always have installed on the hot water inlet an approved non-return valve.



NOTE: Always ensure hot water systems are installed in compliance with manufacturers recommendations and in accordance with all local regulations.

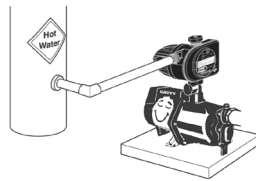

Connection of Mains Scheme or Town Water Supply to either Suction or Discharge of Pumps & Pressure Systems

Most Water Supply Authorities have strict regulations regarding direct connection of pumps to mains water supplies. In most cases an isolating tank is required between mains supply and pump. Davey also recommend this method. Directly applied mains pressure can exceed pump operating pressure and damage pump.

Davey Water Products Pty Ltd can not accept responsibility for loss or damage resulting from incorrect or unauthorised installations.

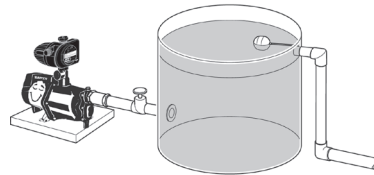

Priming and Operation

The Torrium2® module fitted to your XP or XJ system is provided with a push button "Prime" button. This button is used during initial priming of the pump and also acts as a reset button if the Torrium2® switches out in pump protection mode.

1. Remove priming plug and fill casing and suction line (on flooded suction, simply open gate valve to pump). When full, replace priming plug.

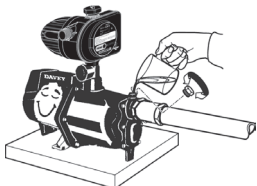

2. Ensure outlet nearest to pump is open.



3. Ensure all valves in suction line are open.

4. Switch on power - The status indicator light will be illuminated green and the pump will run. A full flow of water should be discharged from the open tap.



5. If the pump stops with the tap open see troubleshooting checklist.
6. Close the open outlet or tap and the pump should stop after a few seconds (the status indicator light should be illuminated red (constant). If not, consult the troubleshooting checklist.

To Reset if Pump switches out in Pump Protection Mode

1. Make sure pump is primed.
2. Open tap, push prime button.
3. Close tap and pump will stop.

Power Connection

Connect lead to power supply designated on pump label. Do not use long extension leads as they cause substantial voltage drop, poor pump performance and may cause motor overload.



The Davey Torrium2® fitted to this pump has **status indicator light** mounted on its front panel. These lights will only work when unit is connected to an electrical supply.



The electrical connections and checks must be made by a qualified electrician and comply with applicable local standards.

Auto-retry and Water Return Modes

Should your Torrium2® detect a loss of prime, after stopping the pump, it will wait five minutes before activating Auto-retry and Water Return modes. Auto-retry automatically starts the pump to see if the pump is now primed. It does this after 5 mins, 30 mins, 1 hr, 2 hrs, 8 hrs, 16 hrs and 32 hrs. Water return mode will restart the pump automatically if the Torrium2® detects water flow through it.

Electrical Power Surge Protection

An electrical power surge or spike can travel on the supply lines and cause serious damage to your electrical equipment. The Torrium2® fitted to this pump has a metal oxide varistor (MOV) fitted to help protect it's circuit. This MOV is a "sacrificial" device, meaning that it effectively is gradually damaged every time it takes a surge. The MOV is not a lightning arrestor and may not protect the Torrium2® if lightning or a very powerful surge hits the pump unit.

If the installation is subject to electrical power surges or lightning we strongly recommend the use of suitable additional surge protection devices on ALL electrical equipment.

Surge Protector Status Window

To allow you to check the status of the inbuilt MOV in the Torrium2® there is a viewing window at the back of the Torrium2® above the power lead entry / exit grommet. The MOV is the blue disc shaped component. Should it be consumed due to power spikes it will almost always blacken the viewing port. This will indicate a non-warrantable failure.

In accordance with AS 3350.2.41 we are obliged to inform you that this pump is not to be used by children or infirm persons and must not be used as a toy by children.



NOTE: For protection, the Davey pump motors are fitted with an automatic reset thermal overload, constant tripping of this overload indicates a problem e.g. low voltage at pump, excessive temperature (above 50°C) in pump enclosure.

Pipe Connections

For best performance use P.V.C. or polythene pipes at least the same diameter as the pump's inlet and delivery outlet openings. Larger diameter pipe may be used to minimise resistance to flow when pumping longer distances.

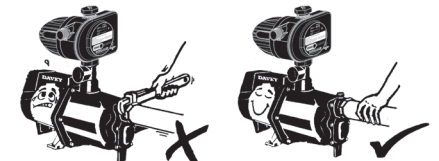

 Do not use pipe thread sealing compounds on any part of this pump. **ONLY use Teflon sealing tape.**

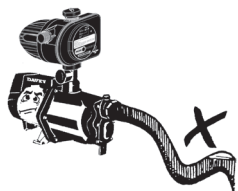

Use unions at pipe connections to enable easy removal and servicing. Use sufficient tape to ensure airtight seal and hand tighten only. To prevent strain on pump threads always support heavy inlet and outlet pipes. If there is a likelihood the water supply may contain solid particles such as pieces of plant or vegetable matter, a filter should be installed before the pump to avoid blocking of water ways. Lay suction pipe at a constant gradient to avoid air

pockets which may reduce pump efficiency.

 **NOTE: Suction leaks are the largest cause of poor pump performance and are difficult to detect. Ensure all connections are completely sealed using thread tape only.**

 Flexible pipe should be considered to allow for movement between building, pump and/or water supply. Braided hose, reinforced hose or polythene pipe are suitable.

Extra Draw-off Capacity

The Torrium2® controller has an in-built accumulator which will accommodate small leaks. In some applications it may be appropriate to install additional accumulator (Supercell pressure tank) capacity. These applications includes:

- Long suction lines (see Suction Lines / Lift)
- Low flow appliances connected to the pump, such as evaporative air conditioners, slow filling toilet cisterns, etc.

Any additional accumulators can be installed either in place of the priming plug (see Figure 1) for tanks up to 20 litres total capacity, or for larger tanks, downstream of the controller (ie. between the controller and the first outlet).

 **NOTE: If fitting a tank to the priming port, you may require a 1" BSP socket, since both Torrium2® prime port and tank are 1" male threads.**

Where extra draw-off capacity is utilised the additional pressure tank should have a pre-charge of 70% of the maximum system (shut-off) pressure.

Evaporative coolers, RO filters and extra draw-off capacity

Where a Torrium2® equipped pump is required to supply water to an evaporative cooler, reverse osmosis (R.O.) filter or similar low flow device, the Torrium2® will detect the limited demand. This will result in the Torrium2® adapting to the slow demand. The pump start pressure will be allowed to drop to a lower cut in pressure each time low flows are detected. To provide the maximum draw-off from the additional pressure tank, the tank's pre-charge should be set at 45% of the pump shut-off pressure.

If normal flow is required from your system, Torrium2® will initiate instant start.

Fit the Supercell pressure tank (up to 20 litres total capacity) to the tank connection/ priming port **with thread tape and pipe socket**. Firmly hand tighten. For larger tanks, these should be installed downstream of the controller.

 **DO NOT USE THREAD SEALING COMPOUNDS, HEMP OR PIPE DOPE!**

Where to use Check Valves and Foot Valves

The Torrium2® controller has an inbuilt non-return (check) valve fitted. In flooded suction installations there is no need to have a suction non-return valve.

In suction lift installations a footvalve will normally be required for the pump to retain prime.

In some suction lift installations there may be good reason to remove the inbuilt check valve to ensure that the discharge pressure is also applied to the suction line and footvalve. This could be where the suction line was very long or where there was concern regarding a leaking footvalve. This may not always be applicable and it is acceptable to retain the inbuilt check valve in the Torrium2 on suction lifts with good suction plumbing.

Should the inbuilt check valve be removed though, an additional accumulator should be fitted to the Torrium2, or discharge pipework as applicable, to ensure the pump is not cycled on shut down. The size of this accumulator will depend on the size, length and type of pipe used on the suction.

Torrium2 Check Valve Removal

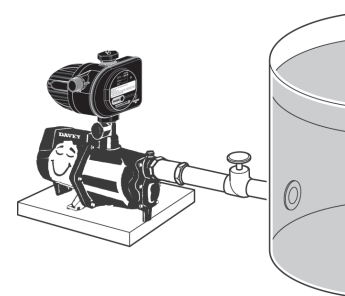
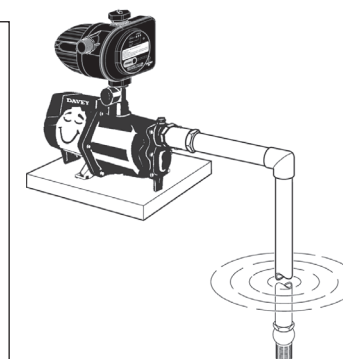
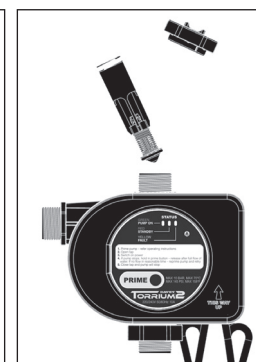
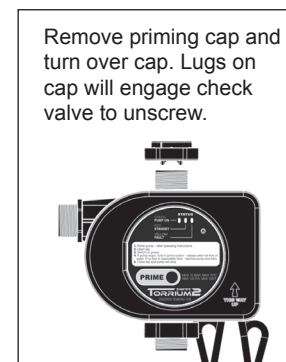

Installations with flooded suction require a gate or isolating valve so water supply can be turned off for pump removal and servicing.

 **Abrasive Materials**
The pumping of abrasive materials will cause damage to the pressure system which will then not be covered by the guarantee.