

Technical user guide of high- voltage XLPE cable systems.

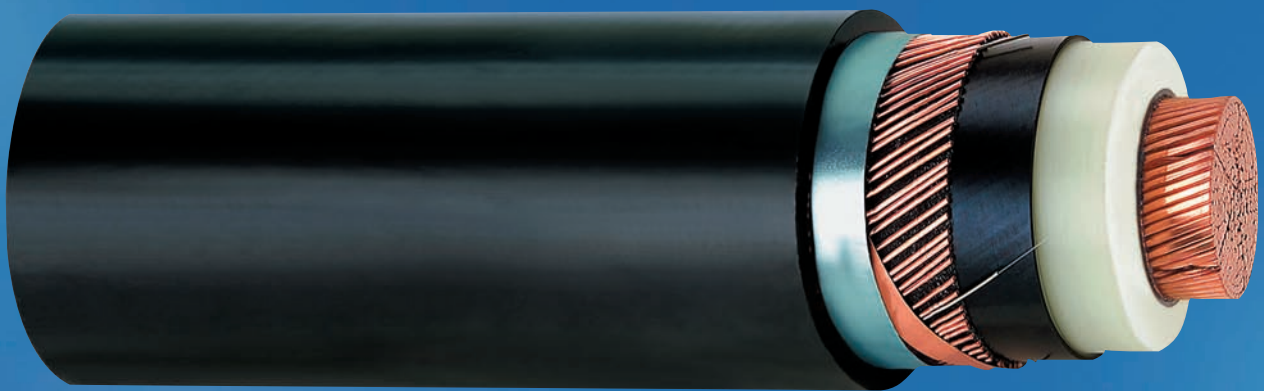

Content

1. General information on High Voltage XLPE Cable Systems _____	3
1.1. Introduction _____	3
1.2. Cable selection process _____	3
1.3. Service life _____	4
2. Cable layout and system design _____	6
2.1. Electrical field _____	6
2.2. Capacity, charging current _____	6
2.3. Inductance, Inductive reactance _____	7
2.4. Losses in cables _____	7
2.5. Earthing methods, induced voltage _____	8
2.6. Short-circuit current capacity _____	10
2.7. Dynamic forces _____	11
2.8. Metallic sheath types _____	11
3. XLPE Cable System Standards _____	13
4. Technical data sheets _____	14
500 / 290 kV XLPE Cable	
400 / 230 kV XLPE Cable	
345 / 200 kV XLPE Cable	
220 / 127 kV XLPE Cable	
132 / 76 kV XLPE Cable	
5. XLPE Cable Reference Projects from Brugg _____	20

1. General information on High Voltage Cable Systems

1.1 Introduction

The development of high voltage XLPE Cable Systems goes back to the 1960's. Since then production and material technology have improved significantly, providing reliable and maintenance-free products to the utility industry.

At present, numerous high voltage XLPE cable systems with nominal voltages up to 500 kV and with circuit lengths up to 40 km are in operation worldwide.

Cable systems are equipped with accessories, which have passed the relevant type tests pursuant to national and international standards, such as long-duration tests. As one of the first XLPE cable manufacturers worldwide Brugg Cables passed a Prequalification Test on a 400 kV XLPE Cable System according to the relevant international standard IEC 62067 (2001).

This test required one year of operation, along with the thermal monitoring of all cables, joints and terminations installed. It was successfully completed at CESI Laboratory in Milan, Italy in 2004.



Test Setup of Prequalification Test

As one of just a few providers worldwide, Brugg Cables can offer a broad range of both XLPE cables (up to 500 kV) and oil-filled cables (up to 400 kV) as well as their accessories.

1.2 Cable selection process

This broad product range together with a systematic analysis of the technical requirements enables the user to find the right solution for every



Typical sample of a 2500mm² 500 kV XLPE cable

Modern XLPE cables consist of a solid *core*, a metallic sheath and a non-metallic outer covering. The *core* consists of the conductor, wrapped with semiconducting tapes, the inner semiconducting layer, the solid main insulation and the outer semiconducting layer. These three insulation layers are extruded in one process. The conductor of high voltage cables can be made of copper or aluminium and is either round stranded or single wires or additionally segmented in order to reduce the current losses.

Depending on the customer's specifications it can be equipped with a longitudinal water barrier made of hygroscopic tapes or powder. The main insulation is cross-linked under high pressure and temperature. The metallic sheath shall carry the short-circuit current in case of failure. It can be optionally equipped with fibers for temperature monitoring. Finally, the outer protection consists of extruded Polyethylene (PE) or Polyvinylchloride (PVC) and serves as an anti-corrosion layer. Optionally it can be extruded with a semiconducting layer for an after-laying test and additionally with a flame-retardant material for installation in tunnels or buildings if required.

application. Additionally, our consulting engineers can assist you in the development of customized solutions.

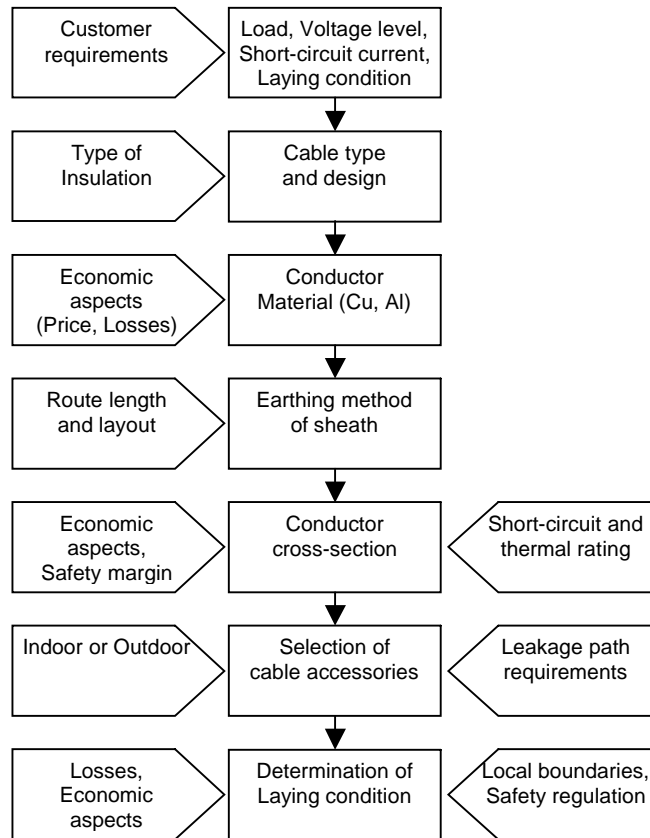

Selection process of cable design

1.3 Service life

Cables are among the investment goods with a high service life of over 40 years. The service life of a cable is defined as its operating time. It is influenced by the constructive design, the production methods and the operating parameters.

Regarding the material technology Brugg Cables has many years of experience and investigation together with extensive experience in the field of cable systems gained over the years.

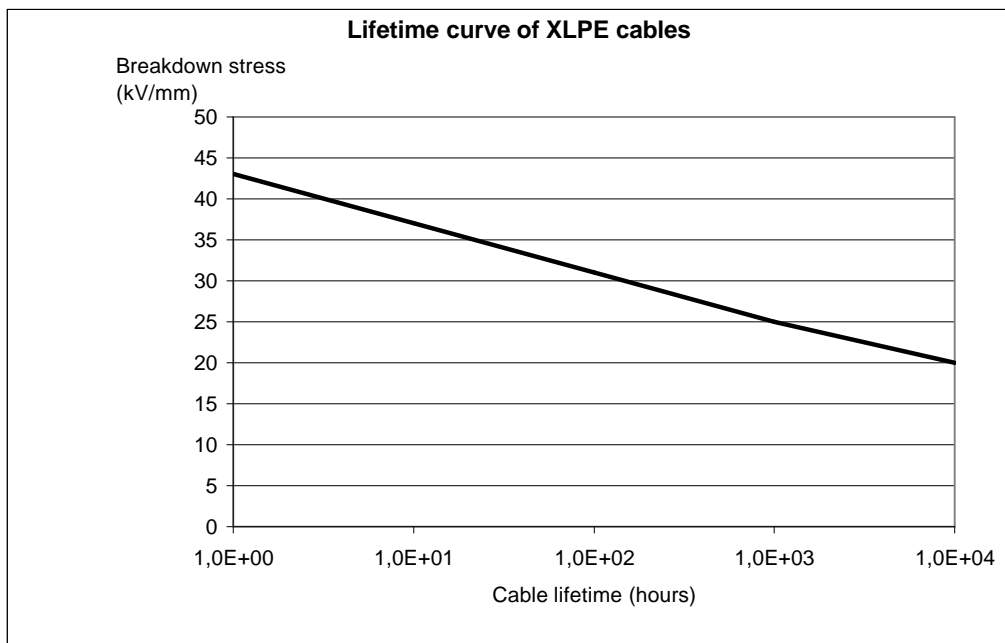

Lifetime curve of XLPE cables

The following rules apply for all organic insulation materials in general:

- An increase of the operating temperature by 8 to 10°C reduces the service life by half.
- An increase of the operating voltage by 8 to 10% reduces the service life by half.

The influence of the voltage on the service life is expressed in the following *service life law* (see graph above):

$$t * E^n = \text{const}$$

with

E = Maximum field strength at the conductor surface of the cable

n = Exponent stating the slope

t = Time

Other *operating parameters* of decisive importance are:

- Voltage level and transient voltages such as switch operations, lightning impulses
- Short-circuit current and related conductor temperatures
- Mechanical stress
- Ambient conditions like humidity, ground temperatures, chemical influences
- Rodents and termites in the vicinity

2. Cable layout and system design

The dimensioning of a high voltage cable system is always based on the specifications and demands of the project at hand. The following details are required for calculation:

- The type of cable insulation
- Nominal and maximum operating voltage
- Short-circuit capacity or short-circuit current with statement of the effect time
- Transmission capacity or nominal current
- Operating mode: permanent operation or partial load operation (load factors)

- Ambient conditions:

- Type of installation
- Ambient temperatures (incl. external effects)
- Special thermal resistance of the ground

The calculation of the admissible load currents (ampacity) and the cable temperatures is performed in accordance with the IEC publication 60287. At Brugg Cables, professional computer programs are in use for the calculation of the various cable data.

2.1 Electrical field

In initial approximation, the main insulation of a high voltage XLPE cable can be regarded as a homogenous cylinder. Its field distribution or voltage gradient is therefore represented by a homogenous radial field. The value of the voltage gradient at a point x within the insulation can therefore be calculated as:

$$E_x = \frac{U_o}{r_x \cdot \ln\left(\frac{r_a}{r_i}\right)} \quad (\text{kV/mm})$$

with

- U_o = Operating voltage (kV)
- r_x = Radius at position x (mm)
- r_a = External radius above the insulation (mm)
- r_i = Radius of the internal field delimiter (mm)

The electrical field strength is highest at the inner semiconductor and lowest above the insulation (below the external semiconductor, $r_x = r_a$).

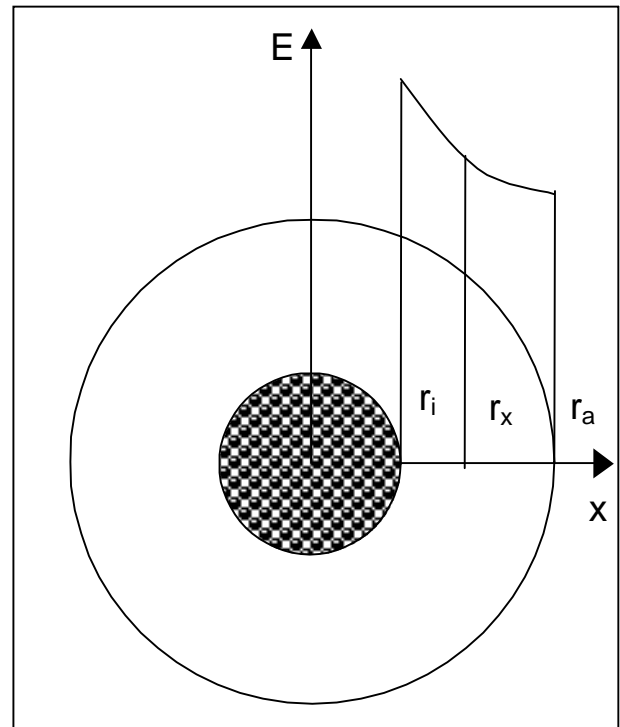

Field distribution within a high voltage XLPE cable

2.2 Capacity, charging current

The operating capacity depends on the type of insulation and its geometry. The following formula applies for all radial field cables:

$$C_b = \frac{5.56 \cdot \epsilon_r}{\ln\left(\frac{D}{d}\right)} \quad (\mu\text{F/km})$$

with

- ϵ_r = Relative permittivity (XLPE: 2,4)
- D = Diameter over main insulation (mm)

d = Diameter over inner semiconductor (mm)

Single-core high voltage XLPE cables represent an extended capacitance with a homogenous radial field distribution. Thus a capacitive charging current to earth results in the following formula:

$$I_C = U_o \cdot \omega \cdot C_b \quad (\text{A/km})$$

with

- U_o = Operating voltage (kV)
- ω = Angular frequency (1/s)
- C_b = Operating capacity ($\mu\text{F/km}$)

2.3 Inductance, Inductive reactance

The operating inductance in general depends on the relation between the conductor axis spacing and the external conductor diameter. Practically, two cases have to be considered:

Laying formation: *trefoil*

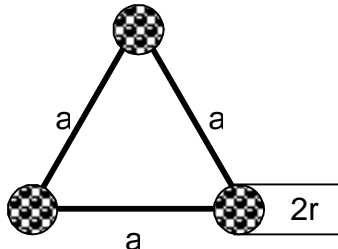

The operating inductance for all three phases calculates as:

$$L = 2 \cdot 10^{-4} \cdot \ln\left(\frac{a}{0,779 \cdot r_L}\right) \text{ (H/km)}$$

with

- a = Phase axis distance (mm)
- r_L = Diameter of conductor over inner semiconducting layer (mm)

Laying formation: *flat*



The *mean* operating inductance for the three phases calculates as

$$L_m = 2 \cdot 10^{-4} \cdot \ln\left(\frac{a'}{0,779 \cdot r_L}\right) \text{ (H/km)}$$

with

- a' = $\sqrt[3]{2} \cdot a$ Mean geometric distance (mm)
- a = Phase axis distance (mm)
- r_L = Diameter of conductor over inner semiconducting layer (mm)

The inductive reactance of the cable system calculates for both cases as:

$$X = \omega \cdot L \text{ [\Omega/km]}$$

with

- ω = Angular frequency (1/s)

2.4 Losses in cables

Voltage-dependent and current-dependent power losses occur in cables.

I) Voltage-dependent losses

Voltage-dependent power losses are caused by polarization effects within the main insulation. They calculate to:

$$P_d = U_o^2 \cdot \omega \cdot C_b \cdot \tan \delta \text{ (W/km)}$$

with

- U_o = Operating voltage (kV)
- ω = Angular frequency (1/s)
- C_b = Operating capacity (μF/km)

Dielectric power loss factors tanδ for typical cable insulations are:

XLPE	(1,5 to 3,5) 10 ⁻⁴
EPR	(10 to 30) 10 ⁻⁴
Oil cable	(18 to 30) 10 ⁻⁴

II) Current-dependent losses

The current-dependent losses consist of the following components:

- Ohmic conductor losses
- Losses through skin effect
- Losses through proximity effect
- Losses in the metal sheath

Ohmic conductor losses

The ohmic losses depend on material and temperature. For the calculation of the ohmic losses R I², the conductor resistance stated for 20°C (R_o) must be converted to the operating temperature θ of the cable:

$$R = R_o [1 + \alpha (\theta - 20^\circ\text{C})] \text{ [\Omega/km]}$$

with

- α = 0.0393 for Copper
- α = 0.0403 for Aluminium

The conductor cross-section and admissible DC resistances at 20°C (R_o) correspond to the standards series pursuant to IEC 60228.

Losses through skin effect

The losses caused by the skin effect, meaning the displacement of the current against the conductor surface, rise approximately quadratic with the frequency. This effect can be reduced with suitable conductor constructions, e.g. segmented conductors.

Losses through proximity effect

The proximity effect detects the additional losses caused by magnet fields of parallel conductors through eddy currents and current displacement effects in the conductor and cable sheath. In practice, their influence is of less importance, because three-conductor cables are only installed up to medium cross-sections and single-conductor cables with large cross-sections with sufficient axis space. The resistance increase through proximity effects relating to the conductor resistance is therefore mainly below 10%.

Losses in the metal sheath

High voltage cables are equipped with metal sheaths or screens that must be earthed adequately.

Sheath losses occur through:

- Circulating currents in the system
- Eddy currents in the cable sheath (only applicable for tubular types)
- Resulting sheath currents caused by induced sheath voltage (in unbalanced earthing systems)

The sheath losses, especially high circulating currents, may substantially reduce the current load capacity under certain circumstances. They can be lowered significantly through special earthing methods.

2.5 Earthing methods, induced voltage

High voltage cables have a metallic sheath, along which a voltage is induced as a function of the operating current. In order to handle this induced voltage, both cable ends have to be bonded

sufficiently to the earthing system. The following table gives an overview of the possible methods and their characteristics:

Earthing method	Standing voltage at cable ends	Sheath voltage limiters required	Typical application
Both-end bonding	No	No	Substations, short connections, hardly applied for HV cables, rather for MV and LV cables
Single-end bonding	Yes	Yes	Usually only for circuit lengths up to 1 km
Cross-bonding	Only at cross-bonding points	Yes	Long distance connections where joints are required

Overview of earthing methods and their characteristics

Both-end bonding

Both ends of the cable sheath are connected to the system earth. With this method no standing voltages occur at the cable ends, which makes it the most secure regarding safety aspects. On the other hand, circulating currents may flow in the sheath as the loop between the two earthing points is closed through the ground. These circulating currents are proportional to the conductor currents and therefore reduce the cable ampacity significantly making it the most disadvantageous method regarding economic aspects.

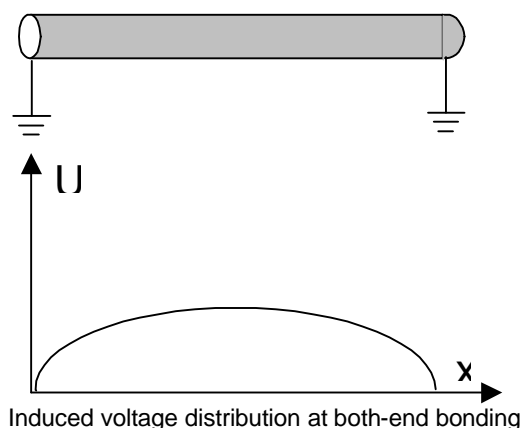

Induced voltage distribution at both-end bonding

Single-ended Bonding

One end of the cable sheath is connected to the system earth, so that at the other end (“open end”) the standing voltage appears, which is induced linearly along the cable length. In order to ensure the relevant safety requirements, the “open end” of the cable sheath has to be protected with a surge arrester. In order to avoid potential lifting in case of a failure, both earth points have to be connected additionally with an earth continuity wire. The surge arrester (*sheath voltage limiter*) is designed to deflect switching and atmospheric surges but must not trigger in case of a short-circuit.

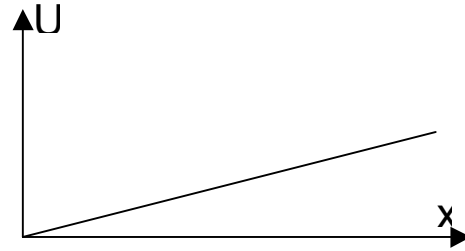
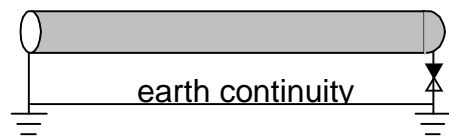

Induced voltage distribution at single-end bonding

Cross-bonding

This earthing method shall be applied for longer route lengths where joints are required due to the limited cable delivery length. A cross-bonding system consists of three equal sections with cyclic

sheath crossing after each section. The termination points shall be solidly bonded to earth.

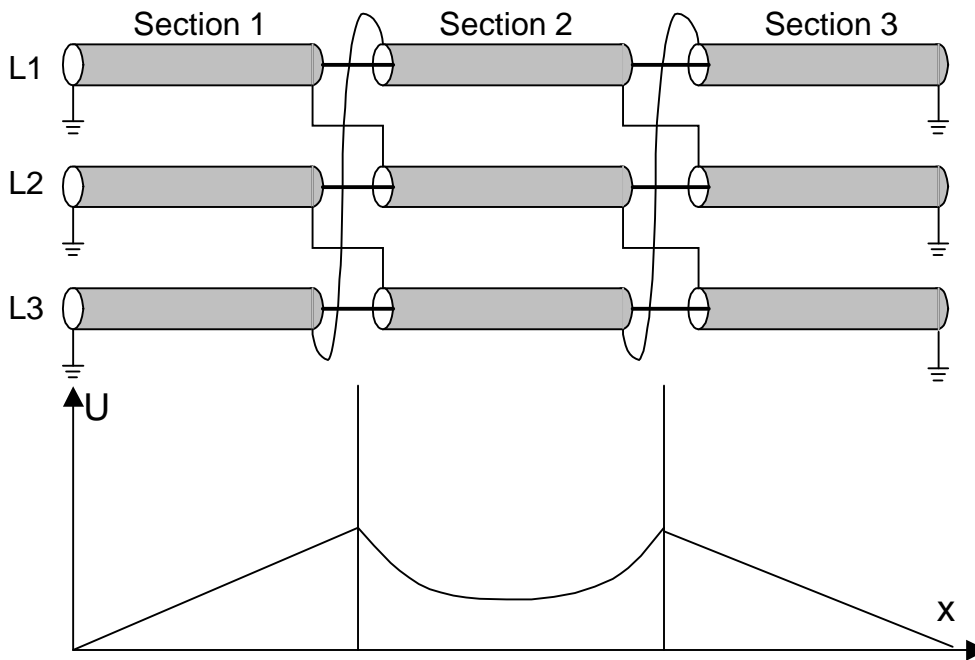

Induced voltage distribution at cross-bonding

Along each section, a standing voltage is induced. In ideal cross-bonding systems the three section lengths are equal, so that no residual voltage occurs and thus no sheath current flows. The sheath losses can be kept very low with this method without impairing the safety as in the two-sided sheath earthing.

Very long route lengths can consist of several cross-bonding systems in a row. In this case, it is recommended to maintain solid bonding of the system ends in order to prevent travelling surges in case of a fault.

In addition to cross-linking the sheaths, the conductor phases can be transposed cyclicly. This solution is especially suited for very long cable lengths or parallel circuits.

Calculation of the induced voltage

The induced voltage U_i within a cable system depends on the mutual inductance between core and sheath, the conductor current and finally on the cable length:

$$U_i = X_M \cdot I \cdot L \quad (V)$$

with

X_M = Mutual inductance between core and sheath (Ω/km)

I = Conductor current per phase (A)

L = Cable length

Two cases must be considered for the determination of the maximum occurring voltage and for the dimensioning of the surge arresters:

$I = I_N$ Normal operating current (A)

$I = I_c$ Three-pole Short-circuit current (A)

The mutual inductance between core and sheath calculates from the following formula:

$$X_M = \omega \cdot L_M \quad (\Omega/km)$$

with

ω = Angular frequency (1/s)

and where L_M is the mutual inductivity between core and sheath (H/km).

The mutual inductivity between core and sheath L_M calculates as follows:

For installation in *trefoil* formation:

$$L_M = 2 \cdot 10^{-7} \cdot \ln\left(\frac{2a}{d_M}\right) \quad (H/km)$$

For installation in *flat* formation:

$$L_M = 2 \cdot 10^{-7} \cdot \ln\left(\frac{2 \cdot \sqrt[3]{2} \cdot a}{d_M}\right) \quad (H/km)$$

with

a = Axial spacing (mm)

d_M = Mean sheath diameter (mm)

2.6 Short-Circuit current capacity

For the cable system layout, the maximum short-circuit current capacity for both – the conductor and the metallic sheath – have to be calculated.

Both values are depending on

- the duration of the short-circuit current
- the material of the current carrying component
- the type of material of the adjacent components and their admissible temperature

The duration of a short circuit consists of the inherent delay of the circuit breaker and the relay time.

Short-Circuit current capacity of conductors

The following table contains the maximum admissible short-circuit currents $I_{k,1s}$ for conductors acc. to IEC 60949 with a duration of 1 second for the different conductor and insulation types.

Insulation material	XLPE		Oil
	Cu	Al	Cu
Conductor material	kA		kA
mm ²	1s; 90..250°C	1s; 85..165°C	1s; 85..165°C
2500	358	237	260
2000	287	190	208
1600	229	152	166
1400	201	133	-
1200	172	114	125
1000	143	95	104
800	115	76	83
630	90	60	66
500	72	47	52
400	57	38	42
300	43	28	31
240	34	23	25

Admissible short-circuit currents

Based on these reference values, the short-circuit currents for other durations can be converted with the following formula:

$$I_{k,x} = \frac{1}{\sqrt{t_c}} \cdot I_{k,1s}$$

with

$I_{k,x}$ = Short-circuit current during x seconds [kA]

t_c = Duration of short-circuit [s]

$I_{k,1s}$ = Short-circuit current during 1 second [kA]

The above stated values were calculated on a *non-adiabatic* basis, which means that heat

transfer from the current carrying component to its adjacent components is allowed.

Short-Circuit current capacity of metallic sheaths

In addition to the above mentioned, the short-circuit current capacity of metallic sheaths depends on their layout. The short-circuit current capacity is different for tubular sheaths and wire screens, but generally the total short-circuit current capacity of a metallic sheath is the sum of the capacity of its components.

Typical metallic sheath layouts with their constructional details are listed in a separate section.

2.7 Dynamic forces

Single-core cables have to be fixed in their position at certain intervals. The calculation of dynamic forces for cable systems is important for the determination of the fixing interval and the layout of the fixing devices. It has to be distinguished between radial (e.g. clamps, spacers) and tangential (belts etc.) forces.

The amplitude of a dynamic force in general is calculated applying the following formula:

$$F_s = \frac{2 \cdot 10^{-7} \cdot I_s^2}{a} \quad (\text{kN/m})$$

with

a = Phase axis distance (mm)

$$I_s = \kappa \cdot \sqrt{2} \cdot I_c$$

wherein

I_s = Impulse short-circuit current [kA]

κ = surge factor (usually defined as 1.8)

I_c = Short-circuit current [kA]

Radial force

The dynamic force that a spacer has to absorb is:

$$F_r = \alpha \cdot F_s$$

F_s = Dynamic force [kN/m]

α = Layout factor (typical value for mid phase: 0.866)

Tangential force

The dynamic force that a fixing belt has to absorb is:

$$F_t = \beta \cdot F_s$$

F_s = Dynamic force [kN/m]

β = Layout factor (value for trefoil: 0.5)

2.8 Metallic sheath types

The metallic sheath of high voltage XLPE single core cables has to fulfill the following electrical requirements:

- Conducting the earth fault current
- Returning the capacitive charging current
- Limitation of the radial electrostatic field
- Shielding of the electromagnetic field

Since high voltage XLPE cables are very sensitive to moisture ingress, the metallic sheath also serves as radial moisture barrier. There are several modes of preventing water and moisture penetrating into the cable and travelling within it along its length. Solutions for closed metallic sheaths can be based on welding, extruding or gluing. Some typical sheath layouts as available from Brugg Cables are shown in the following table.

Typical metallic sheath types

Brugg type XDRCU-ALT



Aluminium laminated sheath with Copper wire screen

- Features:
- Low weight
 - Low losses
 - Low cost

Typical application:
Installation in tunnels, trenches or ducts

Brugg type XDRCU-ALT



Aluminium laminated sheath with Copper wire screen and integrated fibres for temperature sensing

- Features:
- Low weight
 - Low losses
 - Low cost

Typical applications:
Installation in tunnels, trenches or ducts

Brugg type XDRCU-CUT



Copper laminated sheath with Copper wire screen

- Features:
- Low weight
 - Low losses
 - Low cost

Typical applications:
Installation in tunnels, trenches or ducts

Brugg type XDCUW-T



Copper corrugated sheath

- Features:
- 100% impervious to moisture
 - flexible
 - resistant to deformation, pressure and corrosion
 - welded

Typical applications:
All installations in soil, especially in locations with shallow ground water level

Special application:
Installation in vertical shafts (up to 220 m)

Brugg type XDPB-T



Lead sheath

- Features:
- 100% impervious to moisture
 - seamless
 - extruded

Typical applications:
All installations in soil

Brugg type XDRCU-PBT



Lead sheath with Copper wire screen

- Features:
- 100% impervious to moisture
 - seamless
 - extruded
 - increased short-circuit capacity through additional copper wire screen

Typical applications:
All installations in soil

3. XLPE Cable System Standards

Brugg Cables' XLPE cable systems are designed to meet requirements set in national and international standards. Some of these are listed below.

IEC

XLPE cable systems specified according to IEC (International Electrotechnical Commission) are among many other standards accepted.

Some frequently used standards are:

- IEC 60183* Guide to the selection of high-voltage cables.
- IEC 60228* Conductors of insulated cables.
- IEC 60229* Tests on cable oversheaths which have a special protective function and are applied by extrusion.
- IEC 60287* Electric cables – Calculation of the current rating.
- IEC 60332* Tests on electric cables under fire conditions.
- IEC 60811* Common test methods for insulating and sheathing materials of electric cables.
- IEC 60840* Power cables with extruded insulation and their accessories for rated voltage above 30 kV ($U_m=36$ kV) up to 150 kV ($U_m=170$ kV). Test methods and requirements.
- IEC 60853* Calculation of the cyclic and emergency current rating of cables.
- IEC 61443* Short-circuit temperature limits of electric cables with rated voltages above 30 kV ($U_m=36$ kV)
- IEC 62067* Power cables with extruded insulation and their accessories for rated voltage above 150 kV ($U_m=170$ kV) up to 500 kV ($U_m=550$ kV) - Test methods and requirements

CENELEC

In Europe, cable standards are issued by CENELEC. (European Committee for Electrotechnical Standardisation.) Special features in design may occur depending on national conditions.

- HD 632* Power cables with extruded insulation and their accessories for rated voltage above 36 kV ($U_m=42$ kV) up to 150 kV ($U_m=170$ kV). Part 1- General test requirements.

Part 1 is based on IEC 60840 and follows that standard closely.

HD 632 is completed with a number of parts and subsections for different cables intended to be used under special conditions which can vary nationally in Europe.

ICEA / ANSI / AEIC

For North America cables are often specified according to

- AEIC (Association of Edison Illuminating Companies)
- ICEA (Insulated Cable Engineers Association)
- ANSI (American National Standards Institute) or

The most frequently standards referred to are:

- AEIC CS7-93* Specifications for crosslinked polyethylene insulated shielded power cables rated 69 through 138 kV.
- ANSI / ICEA S-108-720-2004* Standard for extruded insulation power cables rated above 46 through 345 kV

ISO Standards

Our systems comply with the requirements of ISO 9001 and ISO 14001 and are certified by Bureau Veritas Quality International.

4. Technical data sheets

500 / 290 kV XLPE Cable - Technical data and Ampacity

400 / 230 kV XLPE Cable - Technical data and Ampacity

345 / 200 kV XLPE Cable - Technical data and Ampacity

220 / 127 kV XLPE Cable - Technical data and Ampacity

132 / 76 kV XLPE Cable - Technical data and Ampacity



500/290 kV XLPE Cable

Single-core XLPE High Voltage Cable with Aluminium laminated sheath

Cable layout

- *Copper* conductor, stranded, cross-sections of 1000 sqmm and above segmented, optionally with longitudinal water barrier
- Inner semiconductive layer, firmly bonded to the XLPE insulation
- XLPE main insulation, cross-linked
- Outer semiconductive layer, firmly bonded to the XLPE insulation
- *Copper* wire screen with semi-conductive swelling tapes as longitudinal water barrier
- *Aluminium* laminated sheath
- HDPE oversheath, halogen-free, as mechanical protection, optionally: with semi-conductive and/or flame-retardant layer

Production process

The inner semiconductive layer, the XLPE main insulation and the outer semiconductive layer are extruded in a single operation.

Special features of metallic sheath

- *Copper* wire screen as short-circuit current carrying component
- *Aluminium* foil, overlapped, 0,25 mm thick, as radial diffusion barrier
- Low weight, low cost, internationally proven design

Applicable standards

IEC 62067 (2001)

**XDRCU-ALT
500/290 kV**



Technical data

Copper conductor cross-section		Outer diameter approx. mm	Cable weight approx. kg/m	Capacitance µF/km	Impedance (90°C, 50 Hz) ••• Ω/km	Surge impedance Ω	Min. bending radius mm	Max. pulling force kN
mm ²	kcmil							
630	1250	122	18	0.12	0.22	54	2450	38
800	1600	123	20	0.14	0.20	49	2500	48
1000	2000	127	23	0.16	0.19	47	2550	60
1200	2400	128	24	0.17	0.19	44	2600	72
1400	2750	129	26	0.19	0.18	42	2600	84
1600	3200	135	29	0.19	0.18	42	2700	96
2000	4000	143	34	0.19	0.17	40	2900	120
2500	5000	144	40	0.23	0.17	37	2900	150

Ampacity

Load Factor		Buried in soil •• 0.7	Buried in soil •• 1.0	Buried in soil ••• 0.7	Buried in soil ••• 1.0	In free air •• -	In free air ••• -
mm ²	kcmil	A	A	A	A	A	A
630	1250	954	806	1026	882	1053	1152
800	1600	1076	901	1170	998	1211	1341
1000	2000	1268	1055	1377	1166	1452	1608
1200	2400	1369	1134	1497	1261	1588	1772
1400	2750	1473	1215	1622	1361	1728	1944
1600	3200	1561	1286	1718	1440	1835	2068
2000	4000	1711	1403	1901	1585	2045	2326
2500	5000	1873	1522	2120	1751	2301	2670

Calculation basis:

Conductor temperature 90°C, 50 Hz, soil temperature 25°C, laying depth 1200 mm, soil thermal resistivity 1.0 Km/W, phase distance at flat formation 30 cm, air temperature 35° - Earthing method: Single-end bonding or Cross-bonding

400/230 kV XLPE Cable

Single-core XLPE High Voltage Cable with Aluminium laminated sheath

Cable layout

- *Copper* conductor, stranded, cross-sections of 1000 sqmm and above segmented, optionally with longitudinal water barrier
- Inner semiconductive layer, firmly bonded to the XLPE insulation
- XLPE main insulation, cross-linked
- Outer semiconductive layer, firmly bonded to the XLPE insulation
- *Copper* wire screen with semi-conductive swelling tapes as longitudinal water barrier
- *Aluminium* laminated sheath
- HDPE oversheath, halogen-free, as mechanical protection, optionally: with semi-conductive and/or flame-retardant layer

Production process

The inner semiconductive layer, the XLPE main insulation and the outer semiconductive layer are extruded in a single operation.

Special features of metallic sheath

- *Copper* wire screen as short-circuit current carrying component
- *Aluminium* foil, overlapped, 0,25 mm thick, as radial diffusion barrier
- Low weight, low cost, internationally proven design

Applicable standards

IEC 62067 (2001)

XDRCU-ALT 400/230 kV



Technical data

Copper conductor cross-section		Outer diameter approx. mm	Cable weight approx. kg/m	Capacitance µF/km	Impedance (90°C, 50 Hz) Ω/km	Surge impedance Ω	Min. bending radius mm	Max. pulling force kN
mm ²	kcmil							
500	1000	113	16	0.12	0.23	56	2300	30
630	1250	114	17	0.13	0.22	53	2300	38
800	1600	115	18	0.15	0.20	48	2300	48
1000	2000	118	21	0.17	0.19	45	2400	60
1200	2400	122	24	0.19	0.19	43	2450	72
1400	2750	123	25	0.20	0.18	41	2450	84
1600	3200	128	28	0.20	0.18	40	2600	96
2000	4000	135	33	0.21	0.17	39	2700	120
2500	5000	136	38	0.26	0.17	35	2700	150

Ampacity

Load Factor		Buried in soil .. 0.7	Buried in soil .. 1.0	Buried in soil ... 0.7	Buried in soil ... 1.0	In free air .. -	In free air ... -
mm ²	kcmil	A	A	A	A	A	A
500	1000	853	723	912	788	924	1006
630	1250	972	819	1049	900	1068	1173
800	1600	1098	917	1199	1020	1228	1367
1000	2000	1298	1076	1416	1195	1478	1647
1200	2400	1402	1158	1534	1290	1612	1804
1400	2750	1509	1241	1665	1394	1755	1980
1600	3200	1600	1315	1767	1477	1869	2112
2000	4000	1760	1440	1956	1628	2078	2376
2500	5000	1931	1565	2190	1804	2347	2739

Calculation basis:

Conductor temperature 90°C, 50 Hz, soil temperature 25°C, laying depth 1200 mm, soil thermal resistivity 1.0 Km/W, phase distance at flat formation 30 cm, air temperature 35° - Earthing method: Single-end bonding or Cross-bonding

Values apply for cables with rated voltages from 380 kV to 400 kV acc. to IEC 62067

345/200 kV XLPE Cable

Single-core XLPE High Voltage Cable with Aluminium laminated sheath

Cable layout

- *Copper* conductor, stranded, cross-sections of 1000 sqmm and above segmented, optionally with longitudinal water barrier
- Inner semiconductive layer, firmly bonded to the XLPE insulation
- XLPE main insulation, cross-linked
- Outer semiconductive layer, firmly bonded to the XLPE insulation
- *Copper* wire screen with semi-conductive swelling tapes as longitudinal water barrier
- *Aluminium* laminated sheath
- HDPE oversheath, halogen-free, as mechanical protection, optionally: with semi-conductive and/or flame-retardant layer

Production process

The inner semiconductive layer, the XLPE main insulation and the outer semiconductive layer are extruded in a single operation.

Special features of metallic sheath

- *Copper* wire screen as short-circuit current carrying component
- *Aluminium* foil, overlapped, 0,25 mm thick, as radial diffusion barrier
- Low weight, low cost, internationally proven design

Applicable standards

IEC 62067 (2001)
ANSI / ICEA S-108-720-2004

**XDRCU-ALT
345/200 kV**



Technical data

Copper conductor cross-section		Outer diameter approx. mm	Cable weight approx. kg/m	Capacitance µF/km	Impedance (90°C, 50 Hz) Ω/km	Surge impedance Ω	Min. bending radius mm	Max. pulling force kN
mm ²	kcmil							
500	1000	113	16	0.12	0.23	56	2300	30
630	1250	114	17	0.13	0.22	53	2300	38
800	1600	115	18	0.15	0.20	48	2300	48
1000	2000	118	21	0.17	0.19	45	2400	60
1200	2400	122	24	0.19	0.19	43	2450	72
1400	2750	123	25	0.20	0.18	41	2450	84
1600	3200	128	28	0.20	0.18	40	2600	96
2000	4000	135	33	0.21	0.17	39	2700	120
2500	5000	136	38	0.26	0.17	35	2700	150

Ampacity

Load Factor		Buried in soil .. 0.7	Buried in soil .. 1.0	Buried in soil ... 0.7	Buried in soil ... 1.0	In free air .. -	In free air ... -
mm ²	kcmil	A	A	A	A	A	A
500	1000	859	728	918	793	927	1009
630	1250	980	825	1056	906	1072	1176
800	1600	1108	925	1208	1027	1233	1371
1000	2000	1311	1087	1427	1205	1485	1652
1200	2400	1416	1170	1547	1301	1619	1810
1400	2750	1526	1255	1680	1407	1763	1987
1600	3200	1617	1329	1783	1491	1877	2120
2000	4000	1780	1456	1975	1643	2088	2384
2500	5000	1956	1586	2214	1825	2359	2750

Calculation basis:

Conductor temperature 90°C, 50 Hz, soil temperature 25°C, laying depth 1200 mm, soil thermal resistivity 1.0 Km/W, phase distance at flat formation 30 cm, air temperature 35° - Earthing method: Single-end bonding or Cross-bonding

Values apply for cables with rated voltages from 330 kV to 345 kV acc. to IEC 62067

220/127 kV XLPE Cable

Single-core XLPE High Voltage Cable with Aluminium laminated sheath

Cable layout

- *Copper* conductor, stranded, cross-sections of 1000 sqmm and above segmented, optionally with longitudinal water barrier
- Inner semiconductive layer, firmly bonded to the XLPE insulation
- XLPE main insulation, cross-linked
- Outer semiconductive layer, firmly bonded to the XLPE insulation
- *Copper* wire screen with semi-conductive swelling tapes as longitudinal water barrier
- *Aluminium* laminated sheath
- HDPE oversheath, halogen-free, as mechanical protection, optionally: with semi-conductive and/or flame-retardant layer

Production process

The inner semiconductive layer, the XLPE main insulation and the outer semiconductive layer are extruded in a single operation.

Special features of metallic sheath

- *Copper* wire screen as short-circuit current carrying component
- *Aluminium* foil, overlapped, 0,25 mm thick, as radial diffusion barrier
- Low weight, low cost, internationally proven design

Applicable standards

IEC 62067 (2001)
ANSI / ICEA S-108-720-2004

**XDRCU-ALT
220/127 kV**



Technical data

Copper conductor cross-section		Outer diameter approx. mm	Cable weight approx. kg/m	Capacitance µF/km	Impedance (90°C, 50 Hz) ••• Ω/km	Surge impedance Ω	Min. bending radius mm	Max. pulling force kN
mm ²	kcmil							
300	600	99	12	0.11	0.25	59	2000	18
500	1000	99	13	0.13	0.23	54	2000	30
630	1250	100	15	0.15	0.22	51	2000	38
800	1600	105	17	0.18	0.20	46	2100	48
1000	2000	111	20	0.19	0.19	44	2250	60
1200	2400	112	22	0.22	0.19	41	2250	72
1400	2750	115	24	0.22	0.18	40	2300	84
1600	3200	116	26	0.25	0.18	38	2350	96
2000	4000	119	30	0.27	0.17	36	2400	120
2500	5000	129	37	0.28	0.17	34	2600	150

Ampacity

Load Factor		Buried in soil ••	Buried in soil ••	Buried in soil •••	Buried in soil •••	In free air ••	In free air •••
		0.7	1.0	0.7	1.0	-	-
mm ²	kcmil	A	A	A	A	A	A
300	600	670	571	714	621	707	768
500	1000	877	739	945	813	944	1038
630	1250	1001	838	1090	930	1092	1213
800	1600	1130	939	1241	1051	1252	1405
1000	2000	1339	1106	1462	1231	1508	1687
1200	2400	1450	1192	1595	1336	1651	1863
1400	2750	1561	1280	1725	1440	1791	2031
1600	3200	1657	1353	1847	1536	1919	2195
2000	4000	1824	1482	2060	1703	2147	2490
2500	5000	2002	1618	2282	1876	2397	2815

Calculation basis:

Conductor temperature 90°C, 50 Hz, soil temperature 25°C, laying depth 1200 mm, soil thermal resistivity 1.0 Km/W, phase distance at flat formation 30 cm, air temperature 35° - Earthing method: Single-end bonding or Cross-bonding

Values apply for cables with rated voltages from 220 kV to 230 kV acc. to IEC 62067

132/76 kV XLPE Cable

Single-core XLPE High Voltage Cable with Aluminium laminated sheath

Cable layout

- Copper conductor, stranded, cross-sections of 1000 sqmm and above segmented, optionally with longitudinal water barrier
- Inner semiconductive layer, firmly bonded to the XLPE insulation
- XLPE main insulation, cross-linked
- Outer semiconductive layer, firmly bonded to the XLPE insulation
- Copper wire screen with semi-conductive swelling tapes as longitudinal water barrier
- Aluminium laminated sheath
- HDPE oversheath, halogen-free, as mechanical protection, optionally: with semi-conductive and/or flame-retardant layer

Production process

The inner semiconductive layer, the XLPE main insulation and the outer semiconductive layer are extruded in a single operation.

Special features of metallic sheath

- Copper wire screen as short-circuit current carrying component
- Aluminium foil, overlapped, 0,25 mm thick, as radial diffusion barrier
- Low weight, low cost, internationally proven design

Applicable standards

IEC 60840 (2004-04)
 AEIC CS7-93
 ANSI / ICEA S-108-720-2004

**XDRCU-ALT
132/76 kV**



Technical data

Copper conductor cross-section		Outer diameter approx.	Cable weight approx.	Capacitance	Impedance (90°C, 50 Hz)	Surge impedance	Min. bending radius	Max. pulling force
mm ²	kcmil	mm	kg/m	µF/km	Ω/km	Ω	mm	kN
240	500	73	6	0,13	0,26	59	1500	14
300	600	76	7	0,14	0,25	49	1550	18
400	800	77	8	0,16	0,23	49	1600	24
500	1000	83	9	0,16	0,22	49	1700	30
630	1250	86	10	0,18	0,22	49	1750	38
800	1600	87	12	0,24	0,20	42	1800	48
1000	2000	91	14	0,27	0,19	39	1850	60
1200	2400	95	15	0,30	0,19	37	1900	72
1400	2750	96	21	0,34	0,18	34	1950	84
1600	3200	99	22	0,35	0,18	33	2000	96
2000	4000	104	27	0,39	0,17	31	2100	120
2500	5000	111	33	0,43	0,17	29	2250	150

Ampacity

Load Factor		Buried in soil ∴	Buried in soil ∴	Buried in soil ∴	Buried in soil ∴	In free air ∴	In free air ∴
mm ²	kcmil	0.7	1.0	0.7	1.0	-	-
240	500	607	513	657	569	631	698
300	600	687	579	745	642	721	799
400	800	789	660	861	737	837	936
500	1000	896	748	979	836	960	1074
630	1250	1020	847	1123	953	1107	1249
800	1600	1154	949	1292	1086	1275	1467
1000	2000	1377	1126	1530	1276	1550	1776
1200	2400	1488	1212	1661	1380	1691	1947
1400	2750	1605	1302	1810	1497	1843	2147
1600	3200	1699	1377	1925	1589	1964	2297
2000	4000	1869	1507	2147	1763	2195	2603
2500	5000	2050	1643	2396	1954	2456	2969

Calculation basis:

Conductor temperature 90°C, 50 Hz, soil temperature 25°C, laying depth 1200 mm, soil thermal resistivity 1.0 Km/W, phase distance at flat formation 30 cm, air temperature 35° - Earthing method: Single-end bonding or Cross-bonding

Values apply for cables with rated voltages from 132 kV to 138 kV acc. to IEC 60840

5. XLPE Cable Reference Projects from Brugg

BRUGG CABLES XLPE cable system experience above 220 kV dates back to the year 1990. Since then, more than 70 systems have been put in operation successfully in this voltage range all over the world.

Furthermore, BRUGG CABLES is one of the leading suppliers of oil-filled cables in the Middle East.



XLPE Cable Projects



Project:

345kV Circuits K-Street #1 and #2
115kV Circuit Hyde Park

Location:

Boston, USA

End-user:

NStar Electric & Gas

Scope of supply BRUGG:

345kV-XLPE-Kabel 1x2750kcmil (1400mm²)
total length: 2'910 ft (0,9 km)

12 GIS Terminations 345kV

115kV-XLPE-Kabel 1x4000kcmil (2000mm²)
total length: 900 ft (0,3 km)

12 GIS Terminations 115kV

Commissioning:

Spring 2006

XLPE Cable Projects



Project:

Piacenza Repowering Project
380kV Connection lines

Location:

Piacenza, Italy

End-user:

EDIPOWER
(Joint Venture Edison, Italy & Atel, Switzerland)

Main contractor:

Consortium *Piacenza 800*
(Techint, Fiat Engineering, Siemens)

Scope of supply BRUGG:

2.4 km 380kV-XLPE-Kabel 1x800mm²
12 GIS Terminations 380kV

Commissioning:

July 2005

XLPE Cable Projects



Project:

220kV Connection line
Combined Cycle Power Plant, Block A 800

Location:

Ludwigshafen, Germany

End-user:

BASF AG

Main contractor:

Siemens AG, Erlangen

Scope of supply BRUGG:

20.5 km 220kV XLPE Cable 1x 2000mm²
6.5 km 220kV XLPE Cable 1x 400mm²
9 Outdoor Terminations
15 GIS-/Transformer Terminations
12 Cross-Bonding Joints
33 Straight Joints

Commissioning:

October 2004

XLPE Cable Projects



Project:

400kV & 220kV Connection lines, Shuweihat IWPP

Location:

United Arab Emirates

End-user:

Abu Dhabi Water and Electricity Authority (ADWEA)

Main contractor:

Siemens AG, Erlangen

Scope of supply BRUGG:

9.2 km 400kV-XLPE-Kabel 1x 630mm²
15 Outdoor Terminations 400kV
15 GIS Terminations 400kV
0.8 km 220kV-XLPE-Kabel 1x1600mm²
3.7 km 220kV-XLPE-Kabel 1x 630mm²
12 Outdoor Terminations 220kV
12 GIS Terminations 220kV

Commissioning:

Autumn 2003

XLPE Cable Projects

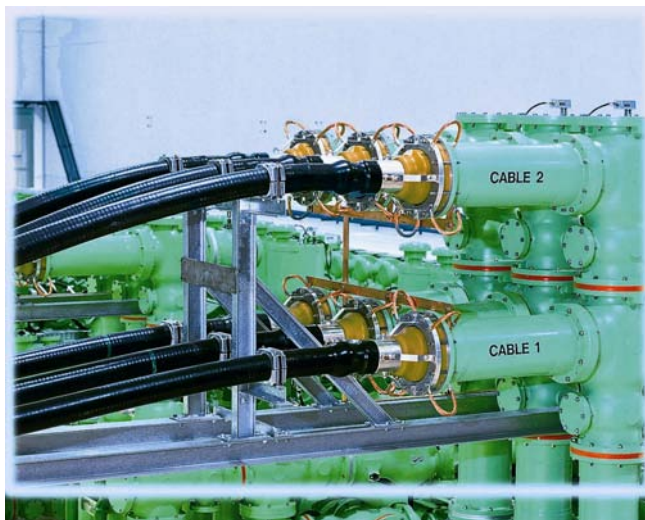

Project:

275kV Connection lines, Substation Creux de Chippis

Location:

Switzerland (Valais)

End-user:

Power Stations Gougra Ltd.

Scope of supply BRUGG:

- 2 km 275kV XLPE Cable 1x 1200mm²
- 0.5 km 275kV XLPE Cable 1x 1600mm²
- 1 km 275kV XLPE Cable 1x 400mm²
- 36 GIS Terminations 300kV
- 10 Transformer Terminations 300kV
- 24 Outdoor Terminations 300kV

Commissioning:

May 1997

XLPE Cable Projects



Project:

HPP Stalden

Replacement of two 275kV Cable connections

Location:

Valais, Switzerland

End-user:

KWM Kraftwerke Mattmark

Scope of supply BRUGG:

2.3 km 275kV XLPE Cable 1x400mm²

6 Outdoor Terminations 275kV

6 GIS Terminations 275kV

Commissioning:

Stage 1: November 2004

Stage 2: December 2005

Brugg Cables. Well connected.

Please contact us. We will be glad to show you our first class customer service. And that with Brugg Cables you will always be well connected.

Business Unit

Power Systems

Klosterzelgstrasse 28
CH-5201 Brugg, Switzerland
Phone +41 (0)56 460 33 33

Including the divisions

High-Voltage Systems

Phone +41 (0)56 460 33 33
Fax +41 (0)56 460 32 67
info.hsanlagen@brugg.com

High-Voltage Accessories

Phone +41 (0)56 460 33 33
Fax +41 (0)56 460 32 98
info.hvaccessories@brugg.com

Power Cables, MV/LV Products

Phone +41 (0)56 460 33 33
Fax +41 (0)56 460 34 83
info.energiekabel@brugg.com

Compound

Phone +41 (0)56 460 33 33
Fax +41 (0)56 460 35 42
info.compound@brugg.com

Business Unit

Telecom & Industry Systems

Klosterzelgstrasse 28
CH-5201 Brugg, Switzerland
Phone +41 (0)56 460 33 33

Including the divisions

Telecom

Phone +41 (0)56 460 33 33
Fax +41 (0)56 460 35 74
info.telecom@brugg.com

Industry

Phone +41 (0)56 460 33 33
Fax +41 (0)56 460 35 74
info.industrie@brugg.com

Security

Phone +41 (0)56 460 33 33
Fax +41 (0)56 460 35 74
info.security@brugg.com