

**Electromagnetic Sieve Shakers
SV005, SV007, SV008**

Impact Test Equipment Ltd
www.impact-test.co.uk & www.impact-test.com

User Guide
User Guide
User Guide

**Impact Test Equipment Ltd.
Building 21 Stevenston Ind. Est.
Stevenston
Ayrshire
KA20 3LR**

T: 01294 602626

F: 01294 461168

E: sales@impact-test.co.uk

Test Equipment Web Site

www.impact-test.co.uk

Test Sieves & Accessories Web Site

www.impact-test.com

CONTENTS

| | |
|-------------------|---|
| Chapter 1 | GENERAL INFORMATION |
| 1.01 | Warnings |
| 1.02 | WARNING and DANGER indications - SIGNS |
| 1.03 | Aim of the Instructions Manual |
| 1.04 | Modifications and enclosures of the Instructions Manual |
| 1.05 | Machine Identification Data |
| 1.06 | Usage |
| 1.07 | Operators |
| 1.08 | Storage |
| 1.09 | Transportation and Movement |
| 1.10 | Packaging removal |
| Chapter 2 | TECHNICAL CHARACTERISTICS |
| 2.01 | General machine description |
| 2.02 | Dimension and weight |
| 2.03 | Electrical supply |
| 2.04 | Noise |
| Chapter 3 | GENERAL SAFETY NORMS |
| 3.01 | General norms |
| 3.02 | Machine Safety devices and protection |
| Chapter 4 | INSTALLATION INSTRUCTIONS |
| 4.01 | Location |
| 4.02 | Handling and movement |
| 4.03 | Electrical connection |
| Chapter 5 | IN FUNCTION - USE |
| 5.01 | Machine calibration – Meters - Indicators |
| 5.02 | Placement |
| 5.03 | Equipping |
| 5.04 | Specimen positioning |
| 5.05 | Switching on the equipment |
| 5.06 | Operation mode |
| 5.07 | Switching the appliance on |
| 5.08 | Normal stop |
| 5.09 | Emergency stop |
| 5.10 | Start up after emergency |
| 5.11 | Stop commanded by Safety circuit |
| 5.12 | Programming |
| 5.13 | Test start up |
| 5.14 | Practical example of usage |
| Chapter 6 | MAINTENANCE |
| 6.01 | Ordinary Maintenance |
| 6.02 | Extraordinary Maintenance |
| 6.03 | Authorised maintenance centres |
| Chapter 7 | GUIDE TO RECOGNISING DAMAGE AND ANOMALIES |
| Chapter 8 | SPARE PARTS AND ACCESSORIES |
| Chapter 9 | INACTIVITY |
| Chapter 10 | DECOMMISSIONING THE MACHINE |



| | |
|------------------|----------------------------|
| Chapter 1 | GENERAL INFORMATION |
|------------------|----------------------------|

| | |
|-------------|-----------------|
| 1.01 | WARNINGS |
|-------------|-----------------|

The manufacturer does not accept any responsibility for direct or indirect damage to people, things or animals and use of the appliance in different conditions from those foreseen.
 The manufacturer reserves the right to make changes to the documentary information or to the appliance without advance notice.
 Check the machine responds to the standards in force in the state in which it has been installed.
 All operations necessary for maintaining machine efficiency before and throughout use are the operator's responsibility
 Carefully read the entire manual before operating the machine.
 It is vital to know the information and limitations contained in this manual for correct machine use by the operator.
 Interventions are only permitted if the operator is accordingly competent and trained.
 The operator must be knowledgeable about machine operations and mechanisms.
 The purchaser must ensure that operators are trained and aware of all the information and clarifications in the supplied documentation.
 Even with such certainty the operator or user must be informed and therefore aware of potential risks when operating the machine.
 Safety, reliability and optimum performance is guaranteed when using original parts.
 Any tampering or modifying of the appliance (electrical, mechanical or other) which has not been previously authorised in writing by the manufacturer is considered abusive and disclaims the constructor from any responsibility for any resulting damage.
 All necessary operations to maintain the efficiency of the machine before and throughout use are the responsibility of the user.

| | |
|-------------|---|
| 1.02 | WARNING AND DANGER INDICATIONS - SIGNS |
|-------------|---|

The machine has been designed and constructed according to the current norms and consequently with mechanical and electrical safety devices designed to protect the operator or user from possible physical damage. Residual risks during use or in some intervention procedures on the device are however present. Such risks can be reduced by carefully following manual procedures, using the suggested individual protection devices and respecting the legal and safety norms in force.
 This manual includes "Warning" and "Danger" indications in relevant chapters. These indications are shown with the words "Danger" or "Warning" in bold font and uppercase to make them highly visible.

| | | |
|---|----------------|--|
|  | WARNING | indicates that machine damage could be caused should indications be ignored. |
|  | DANGER | indicates that machine damage and/or injury to the worker could be caused should indications be ignored. |

"**DANGEROUS ZONE**" indicates any zone inside or in the proximity of the appliance in which a person is exposed to the risk of injury or damage to health.

| | |
|-------------|---------------------------------------|
| 1.03 | AIM OF THE INSTRUCTIONS MANUAL |
|-------------|---------------------------------------|

This manual has been edited with the aim of providing all machine operators with all the necessary information on installation, use and maintenance from production to scrapping in as comprehensive and clear manner as possible.
 All the procedures useful for any foreseeable emergency situations have been listed by the manufacturer and can be verified during use.
 Operators, for whom this manual has been written, due to their competence must give instructions or operate the machine themselves.
 The instructions manual must be carefully consulted by laboratory or site safety managers, equipment operators and any internal and external maintenance workers.
 The manual is integral to the product and refers to this appliance only.
 The manual must be safeguarded and always kept near the equipment so that it can be easily consulted whenever necessary.
IMPORTANT: The manual does not substitute the experience and technical training of the worker but must be considered a guide for carrying out its functions.
 Furthermore all the norms and rules the operator should be aware of or consult for correct use of the machine and/or test performance can be found in the manual.
 This responsibility is entrusted to the installer and Laboratory or Site Manager where the machine is installed.
 The Constructor is available to provide further information.

1.04 MODIFICATIONS AND ENCLOSURES OF THE INSTRUCTIONS MANUAL

This manual reflects the state at the time of the launch of the machine on its market. If any modifications, improvements or adjustments have been made since machine supply the Manufacturer does not have to intervene on the marketed machine and will not consider the machine or the manual deficient or inadequate.

1.05 MACHINE IDENTIFICATION DATA

MODELS:

- SV005
- SV0047
- SV008
-

PRODUCTION DATA : see EC declaration



1.06 USAGE

These sieving units have been developed for sieving tests on fine and wet materials.

This appliance is for the exclusive use which it has been conceived for.

Any other use is considered improper and therefore negligent.

Machine use is allowed only in places free from danger of explosion or fire.

During operation check for conditions of danger.

immediately stop the machine should it be working irregularly, and consult the authorised dealer's Sales Service department.

It is the Client's responsibility to verify at the time of installation and use that no conditions of use arise which are different to those indicated.

Refer to the Constructor when in doubt

1.07 OPERATORS

| | | |
|--|-----------------------|---|
| | DANGER WARNING | The use, transportation, installation, maintenance, demolition and disposal of the appliance are only permitted to "QUALIFIED PERSONNEL". This manual is exclusively aimed at "QUALIFIED PERSONNEL" and contains the necessary information for machine use. |
|--|-----------------------|---|

"QUALIFIED PERSONNEL" means people who, due to their training, experience and education, as well as knowledge of the relevant standards, limitations and measures, have been authorised by the "PLANT SAFETY MANAGER" to carry out any necessary activity and are able to recognise and avoid any possible danger.

The manufacturer recommends that the instructions, procedures and recommendations in this manual and the work safety legislation in force be scrupulously adhered to, even with the use of appropriate protection devices (whether individual or part of the machine).

Knowledge and respect of the instructions, safety warnings and danger in this manual are all necessary for installation, operation, management and machine maintenance with a minimal risk.

The "PLANT SAFETY MANAGER" has the following responsibilities and duties:

- To know the machine functions, its commands, safety and protection devices, possible dangers of use and all the information in this manual in detail. This knowledge can only be gleaned from detailed reading of this manual.
- To know the safety legislation in force in detail in order to operate the machine
- To recognise the "QUALIFIED PERSONNEL" for transportation, handling, installation, use, maintenance, disposal, etc.

- Correctly train and educate the “QUALIFIED PERSONNEL” before allowing them access to the machine. The personnel must also be exhaustively trained with regards to the machine’s protection devices.

- Ensure the machine’s safety devices are not tampered with or removed and are checked on a daily basis. Provide the operator appropriate individual protection devices according to the laws in force.

- The constructor is available for clarification, assistance and training and declines all responsibility for damage to things or people resulting from improper, incorrect and negligent use by untrained personnel.



1.08 STORAGE

| | | |
|---|----------------|---|
|  | WARNING | The appliance must be stored and conserved in the original packaging and in a closed environment, protected from atmospheric agents with a minimum temperature of -15C°, and a maximum of +60C° and a maximum humidity of 70 %. |
|---|----------------|---|

1.09 TRANSPORTATION AND MOVEMENT

| | | |
|---|----------------|--|
|  | WARNING | In order to avoid irreparable machine damage, move with care, do not overturn, protect from rain, do not stack, protect the packaging and its contents from bumps and sources of heat. |
|---|----------------|--|

During transportation and movement it is important to avoid bumps, overloading with other packages, exposure to freezing or heating atmospheric agents, or any other potentially harmful condition to the device, things or people. Machine transportation and movement must be entrusted to Qualified Personnel who can ensure correct movement.

| | | |
|---|-----------------------|---|
|   | DANGER WARNING | Do not transport or move the product should it be impossible to respect the conditions on the packaging or there be any doubts. Request information from the constructor. |
|---|-----------------------|---|

1.10 PACKAGING REMOVAL

After removing the packaging check the machine is complete and that there are no visibly damaged parts. DO NOT USE THE MACHINE and refer to the constructor when in doubt.

| | | |
|---|---------------|--|
|  | DANGER | The components used for packaging (plastic bags, polystyrene, nails, screws, wood, etc) must be kept out of reach of children, as they are sources of danger. These components should be placed in the appropriate containers. |
|---|---------------|--|

| | | |
|---|----------------|---|
|  | WARNING | In order to avoid bumps and overturn adopt the normal and logical precautions. Before disposing of the packaging check all machine components such as accessories, utensils, instructions, documents etc have been removed. |
|---|----------------|---|

Chapter 2 TECHNICAL CHARACTERISTICS

2.01 GENERAL MACHINE DESCRIPTION

The equipment is basically formed by a plate holder for specimens (**B5**). This is supported by springs (**B12**) and is activated by electromagnetic impulses (**B13**). The sieves are subjected to a double vibrating action: vertical and rotational.

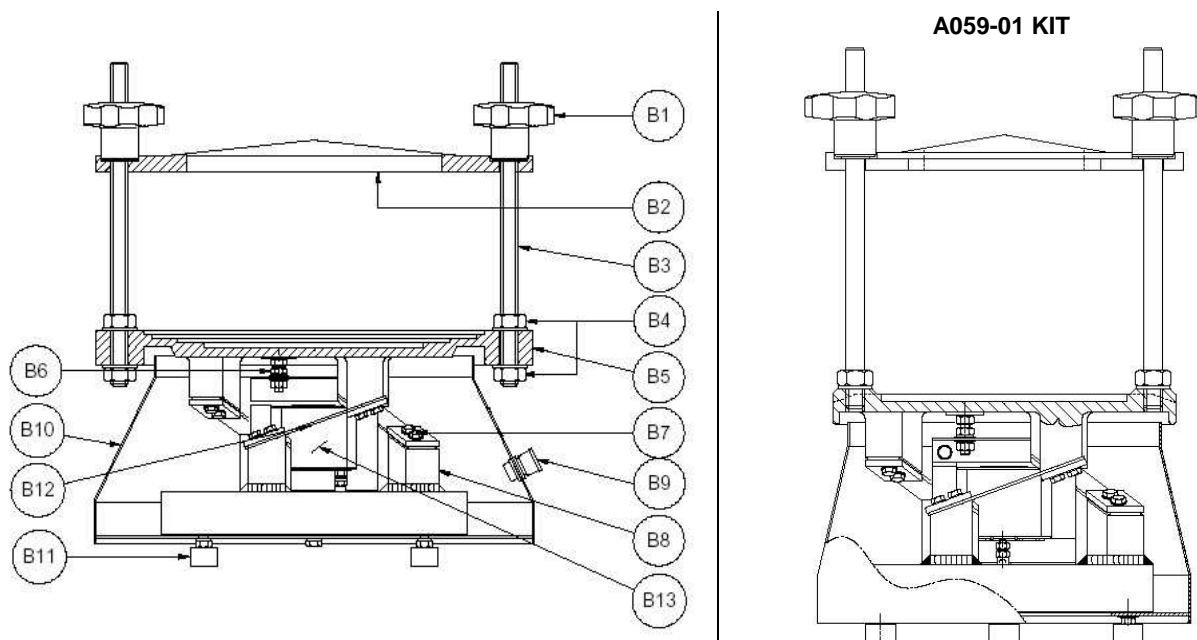

| | | |
|------------|-----------------------------------|---|
| B1 | BLOCKING KNOBS | They secure the upper bar (B2) to the sieves, blocking them firmly to the receiver (B5). |
| B2 | BAR | It secures the sieves to the specimen receiver (B5). |
| B3 | THREADED BARS | They allow to regulate the bar height (B2). |
| B4 | FIXING NUTS | They fix the threaded bars (B3) to the specimen receiver. In the shaker A059-01 KIT is present only one pair of data and the bars B2 are screwed into the sieve holder B5 |
| B5 | SIEVE HOLDER | It can hold several sieves according to the operator's needs. |
| B6 | ADJUSTMENT SCREWS | They allow to fix and to adjust the specimen receiver (B5) to the electromagnet (B13). In this way, the vibrations produced by the electromagnet are transferred to the sieves placed on the receiver (B5). |
| B7 | FIXING SCREWS | These screws fix the springs (B12) to the support columns (B8). |
| B8 | SUPPORT COLUMN FOR SPRINGS | It allows connecting the base to the specimen receiver (B5) by means of the springs (B12). |
| B9 | CABLE FIXING DEVICE | It fixes the feeling cable to the sieve shaker base, avoiding its incidental pull during the normal working procedures. |
| B10 | GUARD | It allows reaching the inside components of the sieve shaker base. The guard is fixed to the base by some screws. |
| B11 | SUPPORTING FEET | They allow laying the sieve shaker steadily on any surface. |
| B12 | SPRINGS | They transfer the vibrations from the electromagnet (B13) to the specimen receiver (B5). |
| B13 | ELECTROMAGNET | It generates the vibrations, which are necessary for a sieving test. Using the Control Panel (C) it is possible to modify the vibrating intensity according to the user's needs. (See Chapter "USE" of this manual for further details). |

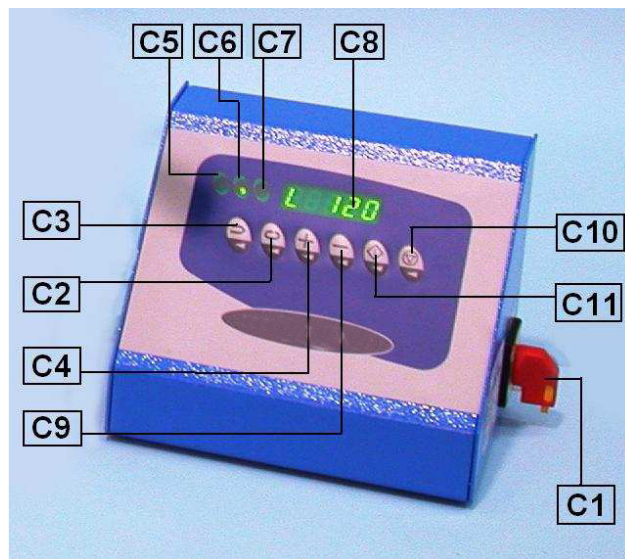

| | | |
|------------|---------------------------------|--|
| C1 | MAIN SWITCH | It allows switching on and off the machine. |
| C2 | “SELECTION” BUTTON | By pressing this key it is possible to select one by one the figures on the right of the numeric display (C8). |
| C3 | “MODE” BUTTON | By pressing this key it is possible to select the working mode of the sieve shaker. This mode is shown by the first figure of the numeric display (C8); See the Chapter “OPERATING MODE” of this manual for further details. |
| C4 | “INCREASE” BUTTON | By pressing this key it is possible to increase the figure shown on the numeric display (C8) in that moment. |
| C5 | LED “SIEVING WORKING” | The lighting of this led means that the machine is vibrating. |
| C6 | LED “CONTINUOUS SIEVING” | The lighting of this led means that the sieve shaker is vibrating in the “continuous mode”. For further details, see Charter “SETTING UP” of this manual. |
| C7 | LED “DATA STORING” | The lighting of this led means that the data shown by the display is being modified (C8). Once the data is stored, the led stops lighting. |
| C8 | NUMERIC DISPLAY | Using this display it is possible to see all the information referred to the sieve shaker working procedures and also to modify the operating parameters; See the Chapter “USE” of this manual for further details. |
| C9 | “DECREASE” BUTTON | By pressing this key it is possible to decrease the figure shown by the numeric display in that moment (C8). |
| C10 | “STOP” BUTTON | By pressing this key, the sieving procedure is stopped. |
| C11 | “START” BUTTON | By pressing this key, the sieving procedure is activated according to the setting up made by the operator. |

2.02 DIMENSION AND WEIGHT

| | SV005 | SV007 | SV008 |
|---------------|-------|-------|-------|
| LENGTH | 380 | 430 | 480 |
| WIDTH | 440 | 460 | 500 |
| HEIGHT | 1080 | 1150 | 1150 |
| WEIGHT | 65 Kg | 80 Kg | 85 Kg |

2.03 ELECTRICAL SUPPLY

| | |
|----------------------|--------------|
| VOLTAGE | 230 V |
| PHASE NUMBERS | 1 |
| FREQUENCY | 50 Hz |
| POWER | 450-750 WATT |

2.04 NOISE

The air noise emission levels shown do not necessarily imply the levels of exposure to the worker. The levels of exposure to the operator are obviously linked to the emission levels of the appliance; however other factors influence the levels of exposure to the operator: length of exposure, environmental characteristics, the presence of other machines etc. The appliance emission levels allow anyway an estimate to be carried out on the dangers due to noise.

| | | |
|---|---------------|---|
|  | DANGER | Continuous use of the appliance and machines predictably present in the installation environment could cause a heightened daily personal exposure to noise. |
|---|---------------|---|

If the daily personal exposure is equal to or more than 85 dB (A) it is advisable to use the Individual Protection Devices (protective headphones, plugs, etc.). If the daily personal exposure is equal to or more than 90 dB (A) it is compulsory to use Individual Protection Devices (protective headphones, plugs, etc.). For further information consult the standards in force in the country of installation.

Average continuous equivalent acoustic pressure level L_{aeq} to the distance of 1 m 59 dB (A):
 Level of acoustic power emitted by the LWA device 67 dB (A):
 Standard EN ISO 3746

Chapter 3 GENERAL SAFETY STANDARDS

3.01 GENERAL STANDARDS

- To ensure the safety of machine operators:
- Any tampering with the appliance not pre-emptively authorised by the manufacturer exempts the manufacturer from any responsibility for damage caused by or to it.
 - The removal or tampering with safety devices entails a violation of the safety standards.
 - Machine use is only allowed in areas where there is no risk of explosions or fires.
 - Only the original fittings can be used. The use of unoriginal fittings exonerates the manufacturer from all responsibility.
 - Check the appliance is in ideal working conditions and that its parts are not worn or faulty before Carry out all necessary maintenance
 - Do not wear loose clothing, ties, chains or anything else which could become caught in the frame or other moving parts of the appliance.
 - Be aware of the danger of electrical shocks from direct or indirect contact due to unforeseen electrical faults.
 - Do not subject the appliance to violent impact.
 - Do not expose the appliance to fire, welding sparks or extreme temperatures.
 - Do not bring the appliance into contact with corrosive substances.
 - Do not wash the appliance with jets of water.
 - Check the workspace around the machine is clear from potentially dangerous objects.
 - The machine operator must wear appropriate work clothing such as protective glasses, gloves and mask in order to avoid damage from, for example, harmful dust projection. Wear a lower back support when lifting heavy parts. There should be no hanging objects such as bracelets or otherwise, long hair should be protected with relevant precautions, shoes must be appropriate for the type of operation to be carried out.

DURING USE

When operating check there are no conditions of danger. Immediately stop the machine when it is functioning irregularly. Contact the authorised Sales Service department.

- For the operator's safety do not touch any part of the appliance when testing and use the appropriate individual protection devices in order to keep the operator safe.

| RISK OR DANGER | SAFETY DEVICE |
|---------------------------|-------------------|
| FINGER OR HANDS SQUEEZING | REINFORCED GLOVES |
| ABRASIONS OR CUT INJURES | REINFORCED GLOVES |
| FALL OF MATERIAL | SAFETY SHOES |

3.02 MACHINE SAFETY DEVICES AND PROTECTION

DEFINITION: Protections are all the safety measures that consist of the use of specific technical means (repairs, safety devices) to protect people from dangers which cannot be limited reasonably in design.

| | | |
|---|---------------|---|
|  | DANGER | Tampering with the protections or any appliance modification could cause risks to users or other exposed people. The manufacturer does not assume any responsibility for direct or in direct damage to people, things or animals following tampering with the protections. |
|---|---------------|---|

On the Control Panel there's the Main Switch (**C1**) also acting as Emergency Switch.

A Guard (optional) can be installed on the machine. This does not allow the operator to touch any moving part of the machine during the test execution. The guard is formed by a wooden box and by an electronic blocking device that disconnects the sieving unit whenever the box is opened during the test running.

Chapter 4 **INSTALLATION INSTRUCTIONS**

4.01 **LOCATION**

The equipment must be placed in an ideal position and environment for the use it has been conceived for (laboratory use and protected from atmospheric agents) and that the machine is placed by a qualified operator.

| | |
|---------------------------------------|--------------------|
| ALLOWED TEMPERATURE: | from +5°C to +40°C |
| ALLOWED RELATIVE HUMIDITY: | from 30% to 70% |
| MAXIMUM HEIGHT OVER SEA LEVEL: | 1000 m |

GENERAL ADVICE

- The machine must be installed in an area which allows ease of access to all parts so that maintenance may be carried out.
- Unauthorised people and objects which could be potential sources of danger must not be permitted in the area surrounding the machine.
- Do not position the equipment near instruments or appliances which could produce vibrations.

4.02 **TRANSPORTATION AND MOVEMENT**

These instructions are applicable to the machine assemblers.
 Ensure the equipment is correctly supported at the lifting point and that the machine does not slip.
 Do not remain in direct line with the application of force and do not allow personnel where there are loads that cannot be adequately supported by mechanical means.

4.03 **ELECTRICAL CONNECTION**

| | | |
|---|---------------|--|
|  | DANGER | Wiring of the electrical system must be carried out by qualified personnel. Before wiring consult the electric plan linked to the instructions manual and the registration plate on the machine for information regarding supply, frequency and nominal current. Connect the earthing system via the PE terminal (yellow-green) before any other connection. Apply a knife switch at the top of the connecting cable of the machine to the power system. The knife switch must be combined with a safety device against the overload with a differential switch (safety switch). The technical features of the safety device must be in accordance with the standards in force in the country where the machine has been installed. |
|---|---------------|--|

ELECTRIC TOLERANCES:

- Real voltage $\pm 10 \%$ of the nominal one
- Frequency:
 - $\pm 1 \%$ of the nominal one in a continuous way
 - $\pm 2 \%$ of the nominal one for a short period
- The harmonic distortion of the sum from the second to the fifth harmonics not more than 10 % of the total voltage as a real value between the conductors. A further distortion of 2% is accepted for the sum from the sixth to the thirtieth harmonics of the real total value between the conductors.
- With reference to the voltage imbalance of the three-phase voltage, the inverted sequence component and the zero sequence component must not be more than 2% of the direct sequence component of the voltage.
- The voltage pulses must not last more than 1,5 ms with an up/down time between 500 ms and 500 ms and a peak value not higher than 200 % of the real value of the nominal tension.

- The electric supply must not be interrupted or zeroed for more than 3 ms at any time. Between two interruptions it must not take more than 1 s.
- The interruptions must not overcome 20 % of the tension peak for more than one cycle. Between two interruptions it must not take more than 1 s.

The manufacturer assumes no liability for any damages to people, things and animals caused by the non-compliance of the above instructions

Chapter 5 | IN FUNCTION - USE

| | | |
|---|---------------------------|---|
|  | DANGER WARNING | Before setting the machine in motion it is essential that the Operator and Safety Manager have read the Instructions Manual and understood all parts of the machine and activities linked to it (Risks, Dangers, Functionality, Operation, Protections, Commands, etc.) |
|---|---------------------------|---|

5.01 | MACHINE CALIBRATION – METERS - INDICATORS

The machine is checked in the factory, using sample equipment periodically checked by officially recognised institutes. These checks cannot guarantee that the machine, meters and indicators will provide accurate values and results conforming to the standards in force in the countries the machine has been installed and used in. Normally such norms envisage calibration check after every movement. In order to obtain correct values and results it is therefore VITAL that the operator, once the machine has been installed and set up and before official tests, has an officially recognised body check the machine characteristics, its calibration and results/values reliability. The manufacturer is exempt from all responsibility in the case of direct and indirect damage from use of the machine without official approval by the relevant bodies.

5.02 | PLACEMENT (ONLY SV007 & SV008 MODELS)

For these sieves is important the placement
The vibrant maximum power can reach values such as to require fixing to the floor of the magnetic shaker.
If the shaker is used more frequently at low intensity values of vibrant, it is not necessary to fix the shaker to the floor, but if the shaker is used at its most vibrant intensity should be fixed to the floor.

The shaker has 3 brackets with holes for fixing to floor, **to fix the shaker, follow these instructions:**

- **Unscrew the three screws and three washers on the bottom of the shaker.**
- **Interpose the 3 brackets between the bottom of setaccitatore and the screw heads (see diagram opposite),and tighten screws.**
- **Use the outer holes of the brackets to anchor the shaker to the ground.**

N.B.: To anchor the brackets to the floor you must check carefully the floor:

- A. If the floor is very compact and resistant (concrete or similar) is sufficient use of expansion bolts with a penetration depth of 70mm
- B. If the floor has a consistency less than concrete or if is composed by friable materials you must use fixing bolts. In these cases it is necessary to use fixing bolts anchored to the floor by foundations cemented to the floor.

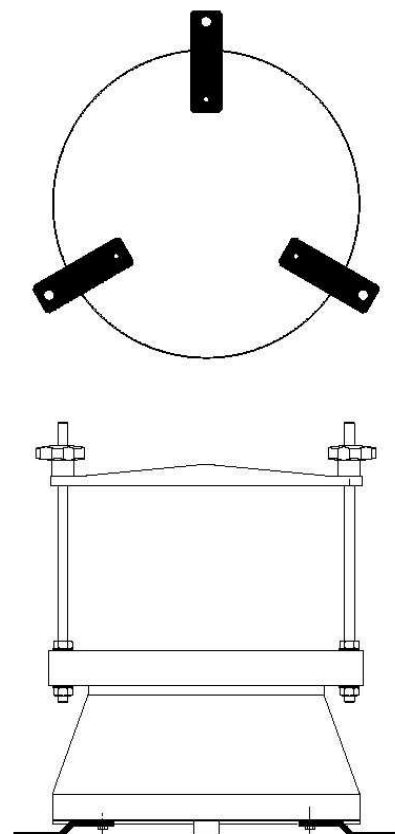

5.03 | EQUIPPING

We give here the right procedures in order which allow to an inexperienced operator tooling up the sieve shaker properly:

INSTALLATION OF THE THREADED RODS

If they were not already screwed, screw the threaded rods (**B3**) to the sieve holder (**B5**) paying attention to following instructions:

1. Insert the rods (**B3**) in their places that are on the sieve holder (**B5**).
2. Tighten the threaded bars (**B3**) on the sieve holder (**A5**) with the fixing nuts (**B4**),
3. Place the bar (**B2**) to the desired height and lock it with the knobs (**B1**).

SIEVES PREPARATION

Depending from the model the appliance can be used with mesh and perforated plate sieves with following diameters Ø200/250/300/315mm and 8" and 12". The sieves must be placed as follows:

1. Position the receiver (not perforated sieve used to collect material) in the middle of the sieve holder (**B5**).
2. Add on the receiver the sieves, paying attention to start on the bottom with the sieves having the smallest openings and continue with the bigger ones
3. At the end add the cover (lid) and fix the series of sieves strongly using the upper blocking bar (**B2**) introduced in the two bars fitted on the vibrating plate.

The system to fit the sieves and the upper bar of the sieves, allows also fitting a lid and receiver for wet tests.

| | | |
|---|----------------|---|
|  | WARNING | Before proceeding to the normal use of the appliance be sure that all the parts are properly tooled up and are suitable for the test that has to be made. |
|---|----------------|---|

5.04 SPECIMEN POSITIONING

| | | |
|--|----------------|---|
|  | WARNING | Before starting a test, ensure that the sieves on the machine are convenient for the specimen you are going to test. (See chapter “ TOOLING UP ”). |
|--|----------------|---|

The material positioning can be done in many different ways depending on the kind of test you want to perform.

For a correct specimen preparation and positioning, please read carefully the standards in force for the kind of test you wish to perform.

5.05 SWITCHING ON THE EQUIPMENT

| | | |
|---|-------------------|--|
|  | ATTENZIONE | Before switching on the appliance, ensure that the sieve shaker is connected to the feeding net. (Consult the chapter “ ELECTRIC CONNECTIONS ” of this manual). |
|---|-------------------|--|

To switch on the machine follow these instructions:

- Put the Main Switch (**C1**) on the “**0**” position.

At this step the sieve shaker is ready for the set up and for the use; on the display (**C8**) the operator will see for a few seconds the code referred to the machine model and then following picture **6.3-I**.

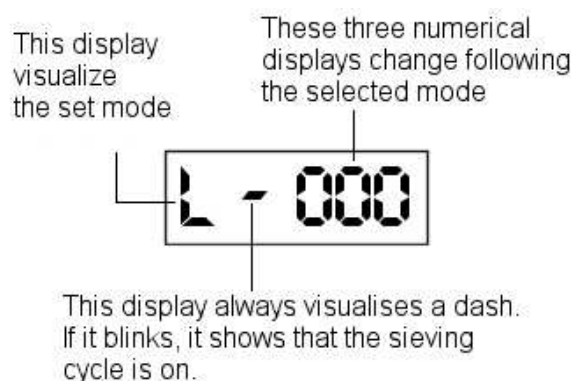

PICTURE 6.3-1

When the machine is switched on, the program opens in L mode and on the numeric display (**C8**) the operator must enter the set up values used during the latest effected test.

In case these values are not proposed again or the above picture is not shown after the switching on, please contact immediately our After Sale Service, since this could represent a bad working of the sieve shaker.

5.06 OPERATING MODE

The working mode of the sieve shaker is visualised on the numerical display (C8) as specified in figure 6.3-I (for the decoding of the visualised value consult the list here below).

| MODE | DESCRIPTION | SETTABLE VALUES |
|------|---|----------------------------------|
| L | Indication of the remaining time to the end of the test | --- |
| T | Indication or selection of the sieving time | 1 – 999 min. |
| H | Indication or selection of the vibrating intensity | 0 – 99 |
| F | Indication or selection of the ON time | 1 – 999 sec. |
| C | Indication or selection of the sieving mode | 0 = Intermittent 1 = Continue |

5.07 SWITCHING THE APPLIANCE ON

By pressing this key, the sieving procedure is activated according to the setting up made by the operator.

5.08 SWITCHING OFF

At the end of a test cycle, follow these instructions in order to switch off the appliance:



1. Remove all the sewers and thoroughly clean the appliance from any possible specimen residual.
2. To switch off the appliance, put the Main Switch (C1) on the “0” position.

5.09 EMERGENCY STOP

Whenever it is necessary the operator can stop the test immediately by positioning the Main Switch (C1) on “0”.

| | | |
|---|----------------|---|
|  | WARNING | Remind that the test interruption causes its complete cancellation. |
|---|----------------|---|

5.10 START UP AFTER EMERGENCY

| | | |
|---|---------------------------|---|
|   | WARNING DANGER | Before starting the machine up again, find and solve the problem, which led to an emergency stop. |
|---|---------------------------|---|

To start the machine, put the Main Switch (C1) on the “I” position. This will reset the appliance to its standard functions.

5.11 STOP COMMANDED BY SAFETY CIRCUIT

The test execution can be interrupted by the safety systems in particular conditions. The appliance is equipped with the following security disposals:

SAFETY GUARDS

The Sieve Shaker can be equipped with a safety system (OPTIONAL) formed by a wooden box and by a micro switch that is activated by the box opening. As soon as the micro switch is activated an electronic device disconnects the feeding to the electromagnet (B13). In this way the machine is stopped.

5.12 PROGRAMMING

| | | |
|---|----------------|--|
|  | WARNING | Do not try to operate the appliance without having carefully read and learnt this manual in all its parts. |
|---|----------------|--|











The sieve shaker has been studied in order to satisfy any operator’s need by means of its easy and accurate setting procedures. The parameters that can be modified are:

- Sieving intensity
- Sieving time
- Sieving mode

For a correct set up please follow with great care our instructions:

SIEVING INTENSITY

The Sieving intensity can be varied entering a value from 0 to 99 on the display.

1. Press several times the key  until on the numeric display (C8) appears the letter H (set up mode referred to the sieving intensity).
2. Press the key . The middle dash of the numeric display (C8) will start lighting.
3. Press the key  to increase the value or the key  to decrease it. The led  is now blinking showing that the value is under modification.
4. Press the key  until the figure on the right is blinking.
5. Press the key  to increase the value or the key  to decrease it.
6. Press several times the key  until you come back to mode L (residual time to end the test). Confirming the data storing, the led  will stop blinking.











| | | |
|---|----------------|--|
|  | WARNING | <p>The intensity of the sieving must not be set over the values that may cause the bumping up to the end of scale of the electromagnet (this condition can be recognized by a marked metallic noise)</p> <p>If this condition is shown, reduce the intensity of the sieving until the unusual noise disappears</p> <p>The non-respect of such shrewdness may cause the braking of some components of the sieve-shaker (springs and electromagnet) and successively the decay of the WARRANTY term</p> |
| | | |

| | | |
|---|----------------|--|
|  | WARNING | <p>Be sure to set the intensity of sieving before initiating the screening, or the shaker may not start.</p> |
|---|----------------|--|

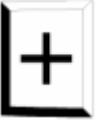
SIEVING TIME

Setting up a value from 1 to 999 minutes can vary the sieving period on the display.

1. Press several times the key  until on the numeric display (C8) appears the letter t (indicating the sieving time or the possibility to select it).

2. Press the key . The figure on the left of the display (**C8**) will start blinking.
3. Press the key  to increase the value or the key  to decrease it. The led  is now blinking, showing that the value is under modification.
4. Press the key  until the middle figure of the display (**C8**) starts blinking.
5. Press the key  to increase the value or the key  to decrease it.
6. Press the key  until the figure on the right of the display (**C8**) starts blinking.
7. Press the key  to increase the value or the key  to decrease it.
8. Press several times the key  until you come back to mode **L** (residual time to end the test). Confirming the data storing, the led  will stop blinking.





SIEVING MODE



The sieving procedure can be selected either in intermittent or continuous way.

INTERMITTENT SIEVING

Every pause lasts 2 seconds (OFF time).



The vibration period between two pauses (ON time) can be varied by setting on the display a value from 1 to 999 seconds:

1. Press several times the key  until on the numeric display (**C8**) appears letter **C** (showing present sieving mode or possibility to select it).
2. Press the key . The figure on the numeric display (**C8**) shall blink.
3. Press the key  to increase the value or the key  to decrease it. The led  is now blinking, showing that the value is under modification.

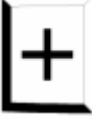

4. Press several times the key  until you come back to mode **L** (residual time to end the test). Confirming the data storing, the led  will stop blinking.

5. Press several times the key  until on the numeric display (**C8**) appears the letter **F** (showing ON time or the possibility to select it).



6. Press the key ; the figure on the left of the display (**C8**) will start blinking.



7. Press the key  to increase the value or the key  to decrease it. The led  is now blinking, showing that the value is under modification.

8. Press the key ; the figure in the middle of the display (**C8**) will start blinking.

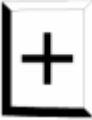
9. Press the key  to increase the value or the key  to decrease it. The led  is now blinking, showing that the value is under modification.







10. Press the key ; the figure on the right of the display (**C8**) will start blinking.

11. Press the key  to increase the value or the key  to decrease it. The led  is now blinking, showing that the value is under modification.

12. Press several times  until you come back to mode **L** (residual time to end the test).
Confirming the data storing, the led  will stop blinking.

CONTINUOUS SIEVING

Press several times the key  until on the numeric display (**C8**) appears the letter **C** (showing the present mode or the possibility to select it):

1. Press the key . The figure on the numeric display (**C8**) shall blink.
2. Press the key  to increase the value or the key  to decrease it and to set up the value 1. The led  is now blinking, showing that the value is under modification.
3. Press several times the key  until you come back to mode **L**. Confirming the data storing, the led  stops blinking.

| | |
|-------------|--|
| NOTE | In the intermittent mode, the total sieving period includes the pauses too. If the user selects a sieving time of 10 minutes, the appliance will stop working after 10 minutes, either in the intermittent or in the continuous mode. |
|-------------|--|

5.13 TEST START UP

Before using the appliance regularly check it is working correctly by carrying out at least one complete empty cycle according to the previous instructions.
Should there be any problem consult the chapter "DIAGNOSTICS".
If the instructions in this manual do not provide the solution to the problem, contact Sales Assistance.

5.14 PRACTICAL EXAMPLE OF USAGE

Hereunder we describe a standard-procedure that allows even to an operator without a wide experience to use the Sieve Shaker in a correct way:



1. Tool up the Sieve Shaker in a proper way, as suggested in the chapter "**TOOLING UP**" of the present manual.

2. Use the key  to select the mode **L**.

| | |
|-------------|---|
| NOTE | The key  can be activated only in L mode. |
|-------------|---|

3. Start up the appliance, acting on key . On the numeric display (**C8**) the count down for the residual sieving time is shown.
4. During the working it is possible to verify the selected values for each parameter:

- Press the key  until on the display (**C8**) appears the desired mode. At this step the operator can read the corresponding values.

| | |
|-------------|---|
| NOTE | In some modes, the operator can change the values by using the key  or  , even if the machine is working. |
|-------------|---|

At the end of the selected sieving time, the appliance stops working and the program gets ready for a new test, keeping the same parameters used for the previous test. In any moment, using the key



the operator can interrupt the test and the program gets ready for a new one, keeping the same parameters used for the broken test.

Capitolo 6 MANTEINANCE

6.01 ORDINARY MAINTENANCE

| | | |
|---|---------------------------|--|
|  | DANGER WARNING | <p>Do not perform maintenance – interventions on the machine which have not been quoted and described in this instructions manual without first contacting the manufacturer.</p> <p>Periodically clean all machine parts and oil the unpainted parts in order to preserve the machine and its efficiency.</p> <p>Avoid the use of solvents which damage paint and parts in synthetic material.</p> |
|---|---------------------------|--|

6.02 EXTRAORDINARY MAINTENANCE

REPLACEMENT OF THE SPRINGS

If one or more than one of the springs (**B12**) breaks, replace it paying attention to following instructions:

1. Turn off the appliance and disconnect it from the main.
2. Disassemble the threaded rods (**B3**) used to fix the sieves from the sieve holder (**B5**).
3. Open the cable-fixing device (**B9**) and push it inside for about 5-10 cm.
4. Turn upside down the sieve shaker (180°), leaning it on the sieve holder.
5. Disassemble the feet (**B11**) from the base and unscrew the screws fixing the frame (**B10**).
6. Disassemble the frame (**B10**) and let it slide along the cable in order not to have it disturbing the following operations.
7. Assemble the feet (**B11**) directly on the base and turn it again upside down (180°) paying attention to lean it on the feet.
8. Unscrew the fixing screws (**B7**) and remove the damaged springs.
9. Install the new springs (**B12**) and fix them as the previous ones, paying attention to close strongly all the screws.
10. Install again the carter (**B10**) following the operations described above here from the end to the beginning.

6.03 AUTHORISED MAINTENANCE CENTRES

For information on the nearest authorised help centre it is essential to contact Impact Test Equipment.

| | |
|------------------|--|
| Chapter 7 | GUIDE TO RECOGNISING DAMAGE AND ANOMALIES |
|------------------|--|

This chapter presents and discusses all the simple problems which could occur during machine use. The appropriately qualified, professional personnel must carry out all the maintenance procedures, check and control, as well as all the repair operations on parts of the machine or the electrical system. Contact Technical Sales Assistance for any other problem not listed on the previous table or should the malfunctioning persist after the intervention of the operator in accordance with the previously mentioned courses of action.

| FAILURE | POSSIBLE CAUSE | CURE |
|---|--------------------------------|--|
| After operating the Main Switch, The machine does not start. | No supply | Verify the correct use of the Main Switch (C4) Verify the Main in the control panel |
| | Fuses are broken | Replace the fuses with the new fuses having the same capacity. The fuses are on the electronic card inside the switch board. |
| After a correct set up of the sieve shaker, pressing the button (C11) the electro magnet does not work | Failure to the electric system | Check if the wires and the connections of the electric circuit are interrupted. |
| | Failure to the electromagnet | Contact our After Sale Service |

| | |
|------------------|------------------------------------|
| Chapter 8 | SPARE PARTS AND ACCESSORIES |
|------------------|------------------------------------|

| | | |
|--|---------------------------|---|
|  | WARNING DANGER | <p>Only original spare parts can be used. Use of unoriginal spare parts exempts the manufacturer from all responsibility. Procedures for substitution of spare parts will be provided by the manufacturer along with the part. For spare parts contact the manufacturer's Sales Service department.</p> |
|--|---------------------------|---|

| | |
|--|--------------------------------|
| | NOISE REDUCTION CABINET |
|--|--------------------------------|

Cabinet lined internally with sound-proofing material for noise reduction to CE Directive.



| | |
|--|-------------|
| | KNOB |
|--|-------------|

Knob for fast clamping/release of the upper beam.
Useful for fast vertical displacement of the beam.
Pack of 2 knobs.

Chapter 9 INACTIVITY

Ensure all machine parts are in safe working order before operating it again should the machine be inactive for a long period of time. When in doubt contact the Manufacturer.

Chapter 10 DECOMMISSIONING THE MACHINE

Should it be decided that the machine is to be no longer used, proceed as follows:

- Disconnect the electrical supply network by removing the connecting cable therefore making it unusable.
- Make the potential sources of danger harmless, such as sharp or protruding parts.
- Dismantle the machine; divide it into similar parts and dispose of according to the standards in force.

Recycling notice for the disposal of electrical and electronic devices



This symbol, shown on the device or on the package and/or the documentation, suggests that the device should not be disposed together with other home garbage at the end of its life cycle.

To avoid further environment, or health-care damage, caused by the unsuitable disposal of garbage, the user should separate this device from other different types of garbage and recycle it in responsibly to avoid the reuse of material resources. Users must take care at the disposal of the equipment by taking it to the nearest recycling site for appropriate recycling treatment for electrical and electronic devices. Gathering and Recycling deplete devices allow the preservation of natural resources and grant them the adequate treatment by respecting health and environment.

For further information on your local recycling site please contact your local council or city waste treatment department. The developer, as producer of electrical and electronic devices, will provide to finance the recycling and treatment services for deplete devices that will come back through these recycling sites, according to the local statement.