

600Mbps Powerline Kit with Gigabit Ethernet



NP507
USER GUIDE

Copyright

Copyright© 2013 NetComm Wireless Limited. All rights reserved.

The information contained herein is proprietary to NetComm Wireless. No part of this document may be translated, transcribed, reproduced, in any form, or by any means without prior written consent of NetComm Wireless.



Note: This document is subject to change without notice.

Save our environment

When this equipment has reached the end of its useful life, it must be taken to a recycling centre and processed separately from domestic waste.

The cardboard box, the plastic contained in the packaging, and the parts that make up this device can be recycled in accordance with regionally established regulations. Never dispose of this electronic equipment along with your household waste. You may be subject to penalties or sanctions under the law. Instead, ask for disposal instructions from your municipal government.

Please be responsible and protect our environment.

This manual covers the following products:

NetComm Wireless NP507 600Mbps Powerline Kit with Gigabit Ethernet

DOCUMENT VERSION	DATE
Initial document release	October 2013

Table 1 - Document Revision History

Table of Contents

Overview	4
About the Product	4
How Does It Work?	4
Package Contents	4
Device Design	5
Determining Connection Rate	8
Getting Started	9
Plan Your Network.....	9
Powerline Utility	11
Powerline User Interface	12
Home.....	12
Private Network Name	13
Simulate Simple Connect Button.....	14
Quality of Service.....	14
Devices	15
Firmware Upgrade.....	16
Frequently Asked Questions	17
Legal and Regulatory Information.....	19
Product Warranty	19
Limitations of Warranty	19

Overview

About the Product

The NP507 Powerline Kit is ready to use out of the box and does not require the installation of driver software to work. It can be connected to computers, routers, gaming consoles, hubs, IPTV set-top boxes, and other Ethernet devices regardless of operating system.

How Does It Work?

Powerline Adapters utilise the existing electrical wiring in the house as a path to create a secured network of computers and Ethernet devices. With a maximum data rate of up to 600Mbps, the NP507 can reliably handle high requirement applications like broadband Internet, high definition video streaming, and Voice over IP.

The NP507 converts digital signals to a complex analog signal that traverses along the electrical wires. When receiving the analog signal, the NP507 converts the analog signal back to digital. To secure the signal, a 128-bit AES encryption is applied.



A Powerline device can only communicate with other Powerline devices that use the same Private Network Name. The Private Network Name can be changed manually using the NP507 Utility software on a computer with a Windows operating system. When you use the software, you have to manually type the Private Network Name for the device. Another way to change the Private Network Name is to use the Simple Connect button. Simple Connect automatically creates an encrypted Private Network Name. It can also be used to reset the Private Network Name or to add a device into an existing Powerline network.

Note: Powerline devices from the Twin Pack are already configured to use a common Private Network Name unique for that pair and are ready to use.

When a Powerline adapter communicates with another device, the Powerline Activity LED  colour gives an indication of the connection rate: Red means below 30 Mbps; Amber means 30 to 80 Mbps; and Green means more than 80 Mbps.



Package Contents

The package contains the following items:

-  2 Powerline Adapters
-  2 Ethernet cables
-  Quick Start Guide

Device Design





LABEL	STATUS	DESCRIPTION
Simple Connect Button		Press to create or join a Powerline network. It can also be used to reset the Private Network Name to a random key.
 Power	Off	No power.
	On	After Simple Connect is pressed for two seconds, this LED will blink to confirm the button press. When Simple Connect is pressed for at least 10 seconds, this LED will blink to confirm the Private Network Name reset.
 Powerline Activity	Off	Device is not connected to a Powerline network.
	On	This LED remains on when the device is part of a Powerline network. The LED colors represents the connection rate within the Powerline network whether it is good (red), better (amber), or best (green). The LED flashes to indicate network activity.
 Ethernet Activity	Off	An Ethernet device is not connected.
	On	An Ethernet device is connected. The LED flashes to indicate Ethernet activity.
Ethernet Port		Accepts either cross or straight Ethernet cable.
Reset Button		Press for 2 seconds to reset to the factory default settings. When you reset to the factory default, all your configuration changes will be removed.

How to Use Simple Connect

Note: The Powerline Adapters that you have received are ready for use straight out of the box. They require no initial set-up or configuration - all you need to do is connect them as detailed in the Quick Start Guide. The following Instructions about the Simple Connect button to configure your network are only applicable if you want to change the default private network name or include more adapters into the same powerline network.

Simple Connect provides a more convenient way of creating your Powerline network without the need to open the Powerline Utility software from a computer. The button has three main functions which includes:

-  Creating a Powerline Network
-  Resetting the Private Network Name
-  Joining an existing Powerline Network



Creating a Powerline Network

To create a Powerline network, you need at least two Powerline devices using random Private Network Names. When you press Simple Connect on both devices, a common Private Network Name will be automatically generated to enable them to communicate with each other.

Note: New Powerlines from a Twin Pack can already communicate with each other out of the box. However, if you intend to create a new Private Network Name using Simple Connect for both devices, you need to reset their Private Network Names to a random key before proceeding.

To create a Powerline network using Simple Connect:

1. Plug your Powerlines side by side where you can easily observe the LED behavior. Upon connection, the LEDs will blink simultaneously and then the Power LED lights on steadily.
2. Press Simple Connect for two seconds on Adapter X. After you release the button, the Power LED will blink. If the Power LED did not blink, press Simple Connect again for two seconds.

Note: Do not press Simple Connect for more than 2 seconds.

3. Press Simple Connect for two seconds on Adapter Y. After you release the button, the Power LED will blink. If the Power LED did not blink, press Simple Connect again for two seconds.

Make sure to press Simple Connect on Adapter Y within two minutes after you press Simple Connect on Adapter X. The LEDs on both devices will switch off and on twice to signify that they are searching for another device to pair with.

Note: Do not press Simple Connect for more than 2 seconds.

4. To confirm if the connection was established, check the LEDs. The Power LEDs and the Powerline Activity LEDs on both Adapters are on.

When the Powerline Activity LED on either Adapter X or Adapter Y is off, this means the pairing is not successful. In this case, please repeat the the process as outlined from point 1.

5. Unplug the Powerline Adapters and then connect them to your Ethernet devices using the Ethernet cables from the product package. After connecting the Ethernet cable, plug the Adapters directly to a wall outlet. An Ethernet-enabled device can be a router, computer, hub, gaming console, IP phone, network printer, or IP TV set-top box.

Note: Powerline adapters work best when connected directly to a wall socket. Avoid plugging it to a power strip or power extension. Other electrical devices in the power strip produce electrical noise that may affect the performance of the Adapter.

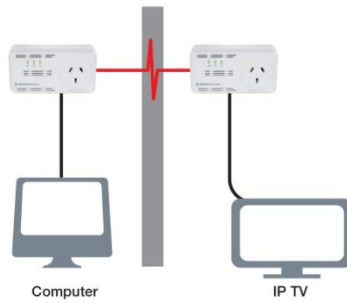

Resetting the Private Network Name

Simple Connect allows you to reset the Powerline Adapter's Private Network Name to a random key. When a Powerline Adapter is reset to a random key, it will not be able to communicate with any other device.

Note: Resetting the Private Network Name is different from resetting the device to its factory default settings. If you intend to reset the device to its factory default settings, press RESET on the device.

To reset the Private Network Name using Simple Connect:

1. Press Simple Connect, wait for the Power LED to blink, and then release. It may take at least 10 seconds for the Power LED to blink.
2. To confirm the Private Network Name reset, the Powerline Activity LED will switch off.

Joining an Existing Powerline Network

To enable a new device to join an existing network, the Simple Connect button copies the Private Network Name of the existing network to the new Powerline adapter. If you pressed Simple Connect from multiple Powerline adapters, only the signal from the first two devices will be processed.

To join an existing Secured HomePlug AV network using Simple Connect:

Step 1

Plug the new Powerline adapter beside one of your existing Powerline adapters. Make sure you can easily observe the LED behavior.

Upon connection, the new Powerline adapter's LEDs will blink simultaneously and then the Power LED remains ON steadily. If there is an Ethernet link, the Ethernet LED is on.

Step 2

Press Simple Connect for 10 seconds from the new Powerline adapter. After you release the button, Power LED and Ethernet LED (Ethernet is connected) will turn off and turn on.



Note: If the Power and Ethernet LED did not turn off and on, press Simple Connect again for 10 seconds.

Step 3

Press Simple Connect Button for two seconds on the existing Powerline adapter. After you release the button, the Power LED continuously blinks. If the Power LED did not blink, press Simple Connect again for two seconds.

Make sure to press Simple Connect Button again on the new Powerline adapter within two minutes after you press Simple Connect from the existing network.

Step 4

To confirm if the connection was established, check the LEDs. The Power LEDs  and the Powerline Activity LEDs  on all Powerline adapters are on.

If the Powerline Activity LED  on the new Powerline adapter is off, this means the pairing was not successful and you must repeat the process again.

Step 5

Unplug the new Powerline adapter and then connect it to your Ethernet device using the Ethernet cables from the product package. An Ethernet-enabled device can be a router, computer, hub, gaming console, IP phone, network printer, or IP TV set-top box. After connecting the Ethernet cable, plug the new Powerline adapter directly to a wall outlet.

Note: Powerline adapters work best when connected directly to a wall socket. Avoid plugging them into a power strip or power extension. The other electrical devices in the power strip create noise that may affect the performance of the Powerline adapters.

Determining Connection Rate

Each colour of the Powerline Activity LED represents a connection rating. The connection rating can only be calculated when the device is part of an existing network. The exact connection rate value can also be viewed using Powerline Utility.

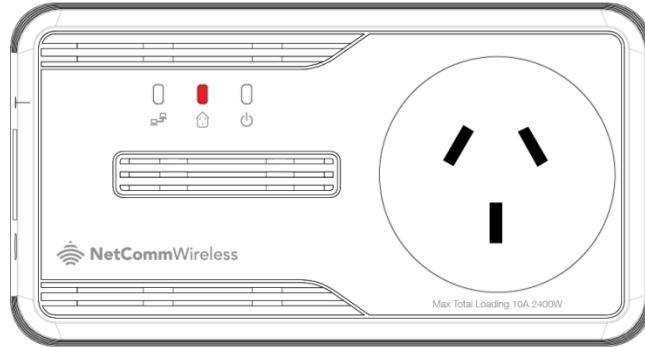

Good (Red) – Connection rate is less than 30 Mbps

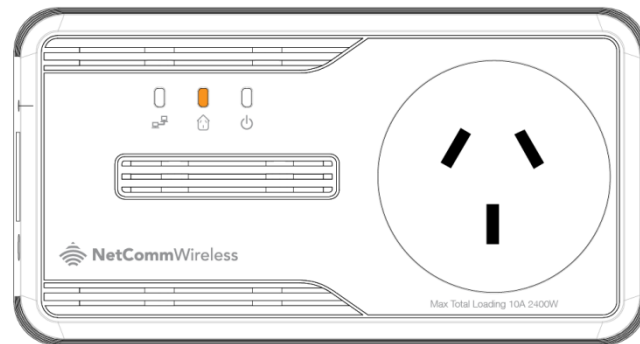

Better (Amber) – Connection rate is between 30 to 80 Mbps



Best (Green) – Connection rate is more than 80 Mbps

Getting Started

Plan Your Network

Here are ideas on how you can plan your Powerline network.

Local Network

Share an ultra fast Internet connection with any computer, wherever it is in the house.

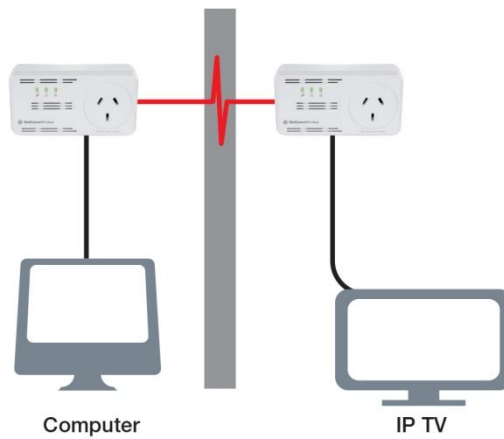

Gaming Network

Connect your gaming console to the Internet and compete with other online players.

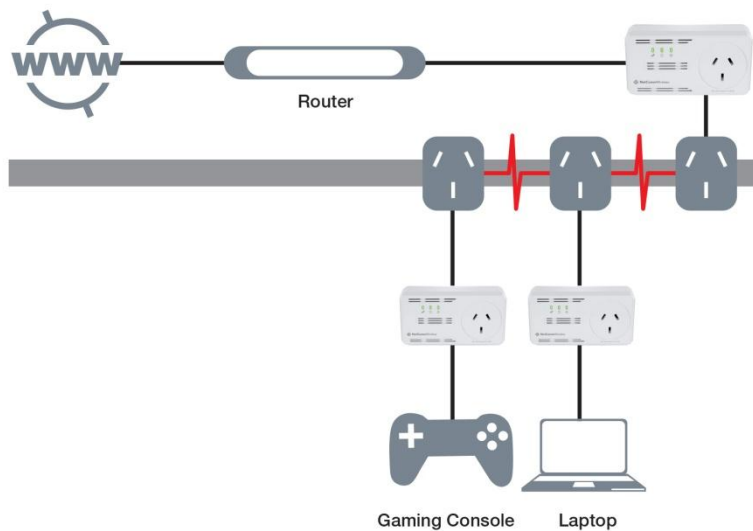

Entertainment Network

Experience IP TV streaming on your home entertainment system.

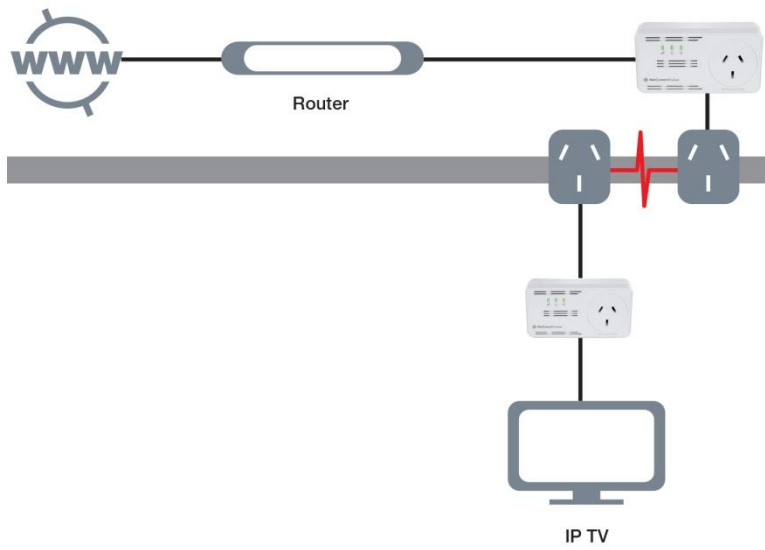

Media Network

Converge your IP devices into a single network.

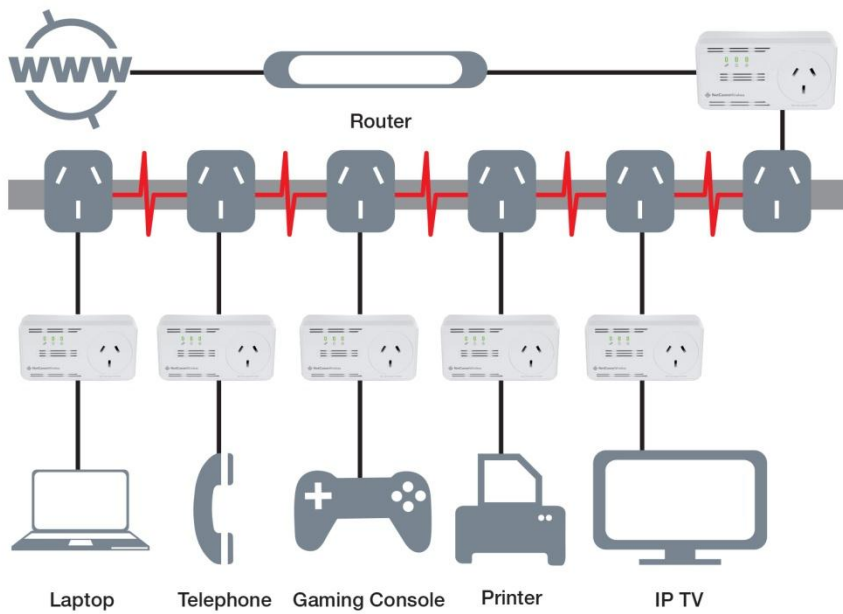







Powerline Utility

Powerline Utility is a software application that allows you to configure the Powerline Adapters. It is mainly used for changing the Private Network Name, detecting other Powerline Adapters in the network, and measuring the throughput of devices. Installation is straightforward and the user interface is easy to use. The Powerline utility is downloadable from the NetComm website. Please go to www.netcommwireless.com and navigate to the product page to download.

Note: To use Powerline Utility, you need a computer using a Windows operating system with the .NET Framework installed. If you do not have .NET installed, the Powerline installer will install it for you.



Requirements

Your computer must meet the following requirements:

-  Windows 98SE, ME, 2000, XP (32 and 64 bit), Vista (32 and 64 bit) or 7 (32 and 64 bit)
-  300 MHz Processor
-  128 Mb of RAM
-  .NET Framework
-  Network Interface Card
-  128 Mb of free hard disk space





Opening Powerline Utility

There are two ways to open Powerline Utility:

-  Double-click the Powerline Utility desktop shortcut and then select Open.
-  Click the Start button, click Programs, and then click the Powerline Utility icon.

Powerline User Interface

The Powerline Utility user interface is divided into tabs. These tabs include:

-  Home
-  Private Network Name
-  Quality of Service
-  Devices
-  Firmware Upgrade

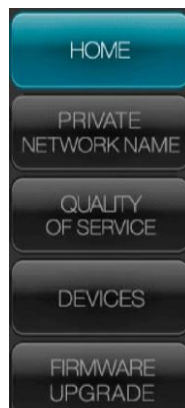



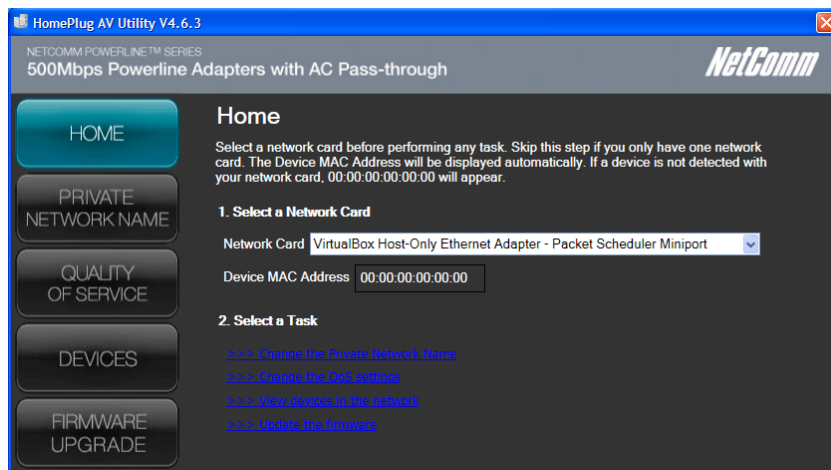

Home



Home provides a list of all the possible tasks you can perform in the Powerline Utility. To start a task, you first need to select the network card connected to your Powerline Adapter. This is most helpful when you have more than one network card in your computer. When you select a network card, the MAC Address of the Powerline Adapter connected to your computer appears. If there is no Powerline Adapter connected to your computer, no MAC address will appear.

After selecting the network card, there are four possible tasks you can perform. These tasks include:

-  Change the Private Network Name
-  Change the QoS settings
-  View devices in the network
-  Upgrade the firmware

Private Network Name

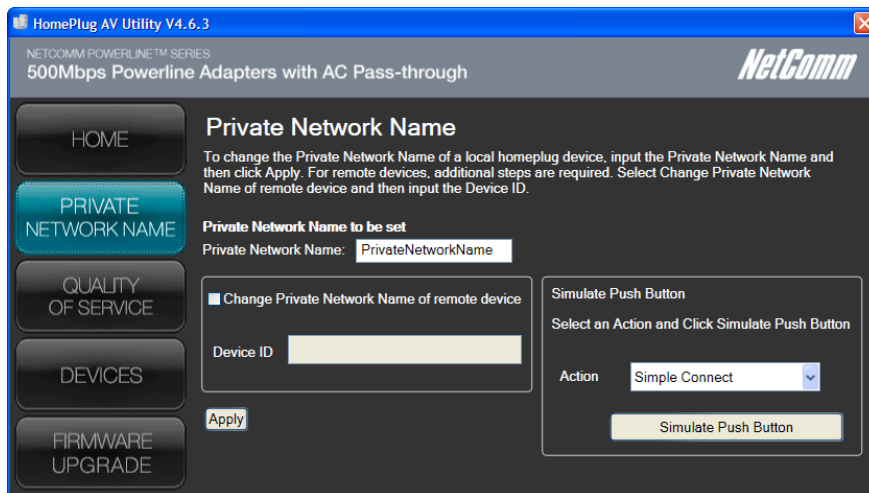

Private Network Name provides the function to manually change the Private Network Name of local and remote Powerline Adapters. A Private Network Name is a string of 8 to 64 characters that enables Powerline devices to communicate with each other.

If you intend to create multiple networks, you can assign different Private Network Names among your devices. You have to, however, make sure that at least two Powerline Adapters have a similar Private Network Name. A Powerline Adapter that uses a unique or random Private Network Name will not be able to communicate with other devices.

Note: In case you cannot connect into the network after changing the Private Network Name, please power cycle the device. To power cycle, disconnect and then reconnect the Powerline Adapters from the power outlet.

Note: You must change the Private Network Name (PNN) on the remote Powerline Adapters before changing your local PNN. If you change the local PNN first you will lose connectivity to the remote.

Local Private Network Name

Local Private Network Name refers to the Private Network Name of the Powerline Adapter that is directly connected to the computer where you use Powerline Utility.

To change the local Private Network Name:

1. Open Powerline Utility.
2. Click Private Network Name.
3. Type the new Private Network Name. This field is case sensitive. It accepts 8 to 64 alphanumeric characters including punctuation marks but no spaces.
4. Click Apply. When the process is complete, the message Settings Applied appears.

Remote Private Network Name

Without leaving your computer, you can change the Private Network Name of remote Powerline devices, provided they are using the same Private Network Name as your local Powerline Adapter. You cannot change the Private Network Name of remote devices that are not currently networked with your local Powerline Adapter.

Note: When changing the Private Network Name of remote devices, you will need the Device ID that appears on the label pasted on the device. It will be more helpful if you list down the Device Password (P/W) of all your Powerline Adapters to enable you to remotely change their settings using the Powerline Utility software.

To change the Private Network Name of a remote Powerline Adapter:

1. Open Powerline Utility.
2. Click Private Network Name.
3. Type the new Private Network Name. This field is case sensitive. It accepts 8 to 64 alphanumeric characters including punctuation marks but no spaces.
4. Select Change Private Network Name of remote device.
5. Click **Apply**. When the process is complete, the message Settings Applied appears.

After changing the Private Network Name of the remote Powerline Adapter, it will no longer be able to communicate with your local Powerline Adapter, unless you use a similar Private Network Name for your local Powerline Adapter.

Simulate Simple Connect Button

Simulate Simple Connect Button allows you to apply functionalities without manually pressing the Simple Connect button on a Powerline device. However, this only works on local devices.

SIMULATE SIMPLE CONNECT BUTTON	
Simple Connect	Select to search and pair with another device, or search and join an existing Powerline network.
NMK Randomize	Select to reset to a random Private Network Name. A Powerline Adapter using a random Private Network Name will be disconnected from the Powerline network and will not be able to communicate with other devices until it forms a new network or joins an existing network.
AVLN Status	Displays the Powerline Adapters Logical Network membership status number.

Note: The Simulate Simple Connect Button functions from Powerline Utility can be used for 600Mbps Powerline versions with or without the Simple Connect button on the device.

To simulate a Simple Connect function:

1. Connect Powerline Adapter to your computer.
2. Select a Simulate Simple Connect Button action:
 - a. Simple Connect
 - b. NMK Randomize
 - c. AVLN Status
3. Click Simulate Button Push.

Quality of Service

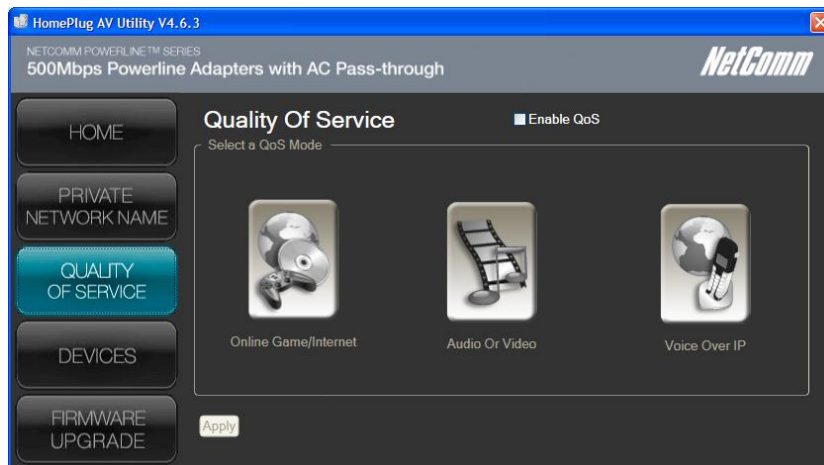

Quality of Service gives you the capability to prioritize particular applications within your network. QoS is not enabled by default.

QoS Modes:



To enable QoS:

4. Open Powerline Utility.
5. Click Quality of Service.
6. Check Enable QoS.
7. Select a QoS mode.

Click **Apply**. When the process is complete, the message **Settings Applied** appears.

Devices

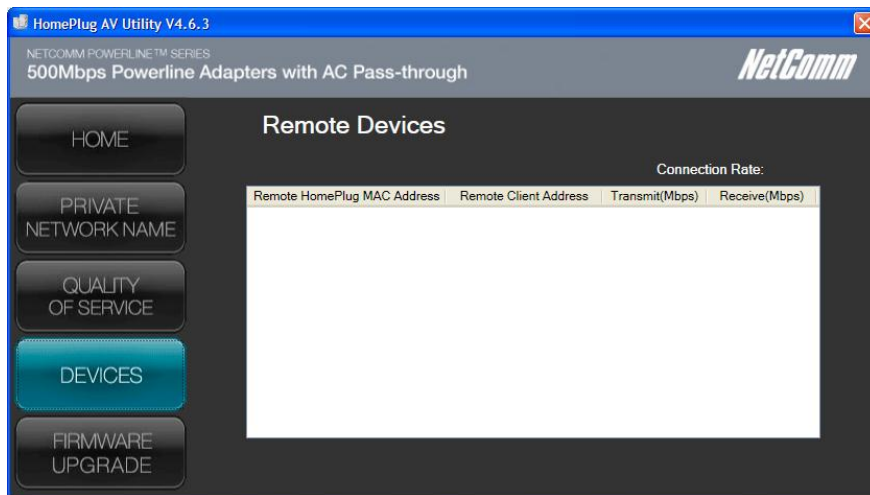

Devices displays information about remote Powerline Adapters detected on the network. Only Powerline Adapters using the same Private Network Name as the local Powerline Adapter will appear in the Remote Devices list.

Devices displays the following information:

DEVICES	
TEI	Displays the Terminal Equipment Identifier.
Device MAC address	Displays the Powerline MAC Address.
Bridge MAC address	Displays the MAC Address of the Ethernet network adapter connected to the Powerline.
Connection rate	Displays the Transmit and Receive connection rates.

Firmware Upgrade

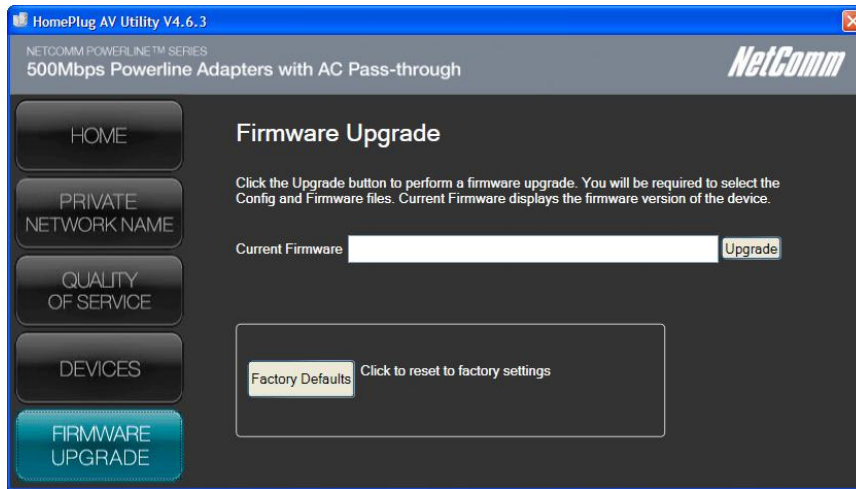

Use this to upgrade the firmware of your PowerlineAdapter. After upgrading, the Powerline Adapter will retain the same Private Network Name and MAC address settings. To upgrade, you need to have both the configuration file (.PIB extension) and firmware file (.NVM extension). Firmware upgrades can be downloaded from www.netcommwireless.com.

To upgrade the firmware of a Powerline:

1. Connect Powerline Adapter to the computer where you are using Powerline Utility.
2. Open Powerline Utility.
3. Click Firmware Upgrade.
4. Click Browse to select the location of the configuration and firmware files. The configuration file has a PIB extension while the firmware file has an NVM extension. After you select the location of the configuration and firmware files, the upgrade will immediately start.

To reset to factory default:

1. Connect the Powerline Adapter to the computer where you are using Powerline Utility.
2. Open Powerline Utility.
3. Click Firmware Upgrade.
4. Click Factory Default.

Note: You can also perform a reset to the factory default when you press the RESET button on the device for 2 seconds.

Frequently Asked Questions

Can I use 600Mbps Powerline Adapters with older Powerline versions?

All Powerline versions can co-exist with each other. 600Mbps Powerline Adapters, however, are not backward compatible with earlier (85Mbps) Powerline releases.

If you will use different versions of 600Mbps Powerline Adapters in a single network, you need to use the Powerline Utility software to create a Private Network Name for all devices. Unlike the new version of 600Mbps Powerline, older versions do not feature the Simple Connect button which enables the device to create a common Private Network Name without using the software.

How does 600Mbps Powerline achieve a higher bandwidth than earlier Powerline releases?

600Mbps Powerline complies with the Powerline standard. It achieves higher data throughput by using a broader frequency spectrum (2-30 MHz rather than 4-21 MHz), by using a better access method (Time Division Multiple Access rather than Carrier Sense Multiple Access/Collision Detection), and by using a better processor with a greater bitload per Hz.

Can 600Mbps Powerline Adapters be used alongside 200Mbps Powerline devices within the network?

600Mbps and 200Mbps Powerline standards can co-exist but they will not be able to communicate with each other.

Which operating system (OS) is compatible with 600Mbps Powerline?

Powerline is operating system independent. However, the Powerline Utility requires a Windows operating system (98SE/ME/2000/XP/ Vista/7) with the .NET Framework installed.

How difficult is it to set up a Powerline network?

Powerline Adapters are plug and play devices. Connect to an Ethernet device, plug it to a wall socket, and it is ready to use. Even the most inexperienced user can set up the network with ease. Installing the Powerline Utility software is only needed if you intend to manually change the Private Network Name or view the connection rate.

How many devices do I need to create a Powerline network?





At least two devices are needed to create a Powerline network.

Is 600Mbps Powerline suitable for triple play i.e. use of data, voice, and video applications simultaneously?

Yes, triple play is supported.

What data transfer rates do I need for high definition TV?

A variety of HDTV resolutions are available. The following are the most common resolutions opposite the required transfer rate:

-  720p, mpeg2: 09-10 Mbps
-  720p, mpeg4: 06-08 Mbps
-  1080i, mpeg2: 12-15 Mbps
-  1080i, mpeg4: 08-10 Mbps

Does 600Mbps Powerline have a security mechanism?

Yes. 600Mbps Powerline uses 128-bit AES encryption.

Does the technology support multicast video server streams (IP-TV)?

Yes.

Do I need an Automatic Voltage Regulator (AVR) for Powerline networking?

No. Powerline can operate in an environment using 100-240V.

How many Powerline Adapters can operate in one household?

Up to 15 devices can be used within the household.

What is the maximum range of a 200Mbps Powerline network?

The maximum range is 200 meters.

If one Powerline adapter is connected to a LAN switch, is it possible for other computers in the switch to communicate with other Powerline devices?

Yes.

Can my neighbors access my Powerline network?

Your electric meter prevents any signal from going outside your household. However, we strongly suggest that you create your own personalized Private Network Name to prevent unauthorized access into your network.

How much is the power consumption of 200Mbps Powerline on a 230-volt power supply?

Powerline has a power consumption of 4.5 watts when in use.

Can I use Powerline Adapters to connect computers located in different floors of the building?

Yes, as long as the electric wires are connected and do not exceed 200 meters.

Can I use Powerline Adapters in an old house with old power supply lines (partly without separated ground wire)?

Yes. However, performance may be affected because of the quality of the wires.

Can I plug Powerline Adapters into a multiple socket switch or do I have to plug it directly to the wall socket?

You can plug Powerline Adapters into a multiple socket switch. However, we strongly advise to plug it directly to a wall socket to achieve optimal performance.

Do I need electrical grounding for the device?

Powerline networks do not require electrical grounding.

After a blackout, will the Powerline Adapters switch on automatically?

Yes. If you experience connection issues, unplug the device and plug it back.

What will happen if I connect two Powerlines Adapters to the same router?

This will cause collision and slow down the network traffic. To prevent collision, you need to assign different Private Network Names on each Adapter.

Legal and Regulatory Information

This manual is copyright. Apart from any fair dealing for the purposes of private study, research, criticism or review, as permitted under the Copyright Act, no part may be reproduced, stored in a retrieval system or transmitted in any form, by any means, be it electronic, mechanical, recording or otherwise, without the prior written permission of NetComm Limited. NetComm Limited accepts no liability or responsibility, for consequences arising from the use of this product. NetComm Limited reserves the right to change the specifications and operating details of this product without notice. NetComm is a registered trademark of NetComm Limited. All other trademarks are acknowledged the property of their respective owners.

Product Warranty

The warranty is granted on the following conditions:

1. This warranty extends to the original purchaser (you) and is not transferable;
2. This warranty shall not apply to software programs, batteries, power supplies, cables or other accessories supplied in or with the product;
3. The customer complies with all of the terms of any relevant agreement with NetComm and any other reasonable requirements of NetComm including producing such evidence of purchase as NetComm may require;
4. The cost of transporting product to and from NetComm's nominated premises is your responsibility; and,
5. NetComm does not have any liability or responsibility under this warranty where any cost, loss, injury or damage of any kind, whether direct, indirect, consequential, incidental or otherwise arises out of events beyond NetComm's reasonable control. This includes but is not limited to: acts of God, war, riot, embargoes, acts of civil or military authorities, fire, floods, electricity outages, lightning, power surges, or shortages of materials or labour.
6. The customer is responsible for the security of their computer and network at all times. Security features may be disabled within the factory default settings. NetComm recommends that you enable these features to enhance your security.



The warranty is automatically voided if:

1. You, or someone else, use the product, or attempts to use it, other than as specified by NetComm; -
2. The fault or defect in your product is the result of a voltage surge subjected to the product either by the way of power supply or communication line, whether caused by thunderstorm activity or any other cause(s);
3. The fault is the result of accidental damage or damage in transit, including but not limited to liquid spillage;
4. Your product has been used for any purposes other than that for which it is sold, or in any way other than in strict accordance with the user manual supplied;
5. Your product has been repaired or modified or attempted to be repaired or modified, other than by a qualified person at a service centre authorised by NetComm; and, 6. The serial number has been defaced or altered in any way or if the serial number plate has been removed.

Limitations of Warranty

The Trade Practices Act 1974 and corresponding State and Territory Fair Trading Acts or legalisation of another Government ("the relevant acts") in certain circumstances imply mandatory conditions and warranties which cannot be excluded. This warranty is in addition to and not in replacement for such conditions and warranties.

To the extent permitted by the Relevant Acts, in relation to your product and any other materials provided with the product ("the Goods") the liability of NetComm under the Relevant Acts is limited at the option of NetComm to:

-  Replacement of the Goods; or
-  Repair of the Goods; or
-  Payment of the cost of replacing the Goods; or

 Payment of the cost of having the Goods repaired.

All NetComm ACN 002 490 486 products have a standard 12 months warranty from date of purchase. However some products have an extended warranty option (refer to packaging). To be eligible for the extended warranty you must supply the requested warranty information to NetComm within 30 days of the original purchase by registering on-line via the NetComm web site at www.netcommwireless.com