

SoClean²

PAP Disinfecting Device User Guide

For all PAP Devices (*Positive Airway Pressure*)

CPAP, APAP, Bi-PAP

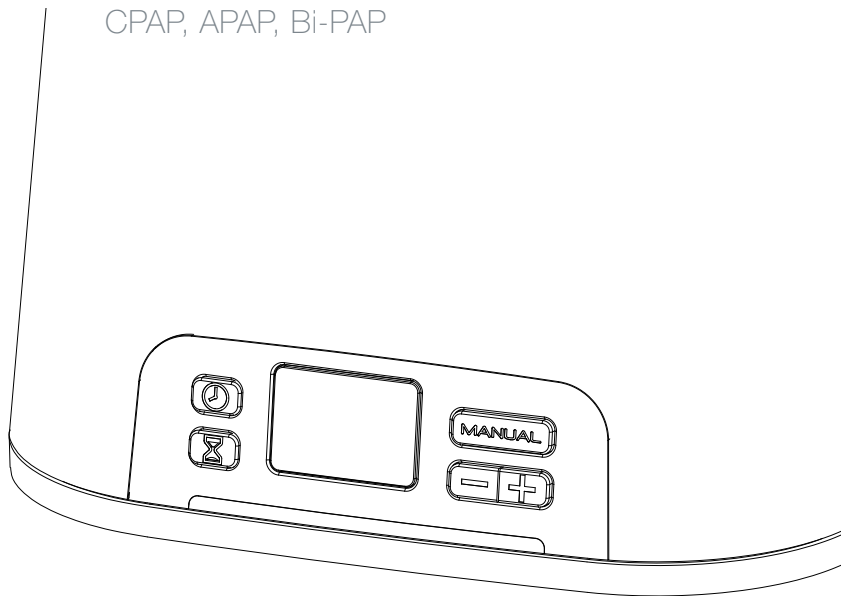

Thank You!

Thank you for your purchase of the SoClean 2 PAP disinfecting system.

Please familiarize yourself with this manual and the operation of the unit. After a few simple steps, you'll find that daily disinfecting of your PAP equipment has never been easier. The SoClean disinfecting process eliminates bacteria, mold, viruses and other pathogens, without the need for water or messy liquid chemicals.

Better Rest Solutions is committed to developing innovative and safe ways to improve the health and well-being of PAP users. Please feel free to contact us with any questions you may have at www.BetterRestSolutions.com.



Contents









1. Indications for Use, Cautions, and Specifications.....	4
2. Included with your SoClean	5
3. Important Supplies	6
4. Understanding Your PAP Machine	7
5. Getting Started.....	8
6. Your SoClean Timer & Display	11
7. Using your SoClean.....	15
8. Care and Maintenance for your SoClean.....	17
9. FAQ.....	18
10. Classification, Symbols, FCC Notice.....	19

Indication of Use, Cautions, and Specifications

Indications for Use: The SoClean is a general Positive Airway Pressure (PAP) disinfecting unit and is intended to be used in the home. A individual who uses Positive Airway Pressure (PAP) for Obstructive Sleep Apnea (OSA) treatment can use the SoClean to disinfect his or her PAP equipment when the daily cleaning procedures are not followed or when the user wants the added benefit of thorough PAP equipment disinfection.

The SoClean is designed to be attached to a user's PAP machine continuously, while only running when the mask is inside the disinfecting chamber.

Contraindications for Use: Do not use SoClean if a fragrant essence is used in the PAP water reservoir or if highly fragrant detergents are used to clean the PAP equipment. Discontinue use if acne or rash develops along mask contact line.

-
-  **DANGER:** Keep away from water sources including rain, bathtubs, sinks and pools.
 -  **DANGER:** Keep away from children. It is not a toy!
 -  **DANGER:** Do not use in explosive air environments, near gas vapors, or other flammables, etc.
 -  **DANGER:** Do not place any items on top of SoClean Unit, particularly flammables or ignitable items.
 -  **DANGER:** Never place any living thing inside.
 -  **WARNING:** Do not dismantle the SoClean unit.
 -  **WARNING:** Do not run the SoClean for more than 30 minutes consecutively.
 -  **WARNING:** Please be aware that there are sensitive electronics inside the SoClean. If you need to clean your SoClean, wipe with a damp cloth. Do not submerge your SoClean or use any chemical cleaners to clean out the inside of the SoClean chamber.

Electrical Characteristics

Adaptor input: AC 100~240V,
50/60HZ
Adaptor output: DC 12V, 1.5A Max
Power Consumption: 18W Max

Environmental Characteristics

Operating: 50F to 100F,
15% to 70% humidity
Storage: -4F to 131F,
15% to 70% humidity

Physical Characteristics

Dimensions: 7.5"x6.5"x8.5"
Weight: 5.6lbs
Cord Length: 4' 8"

Included with your SoClean

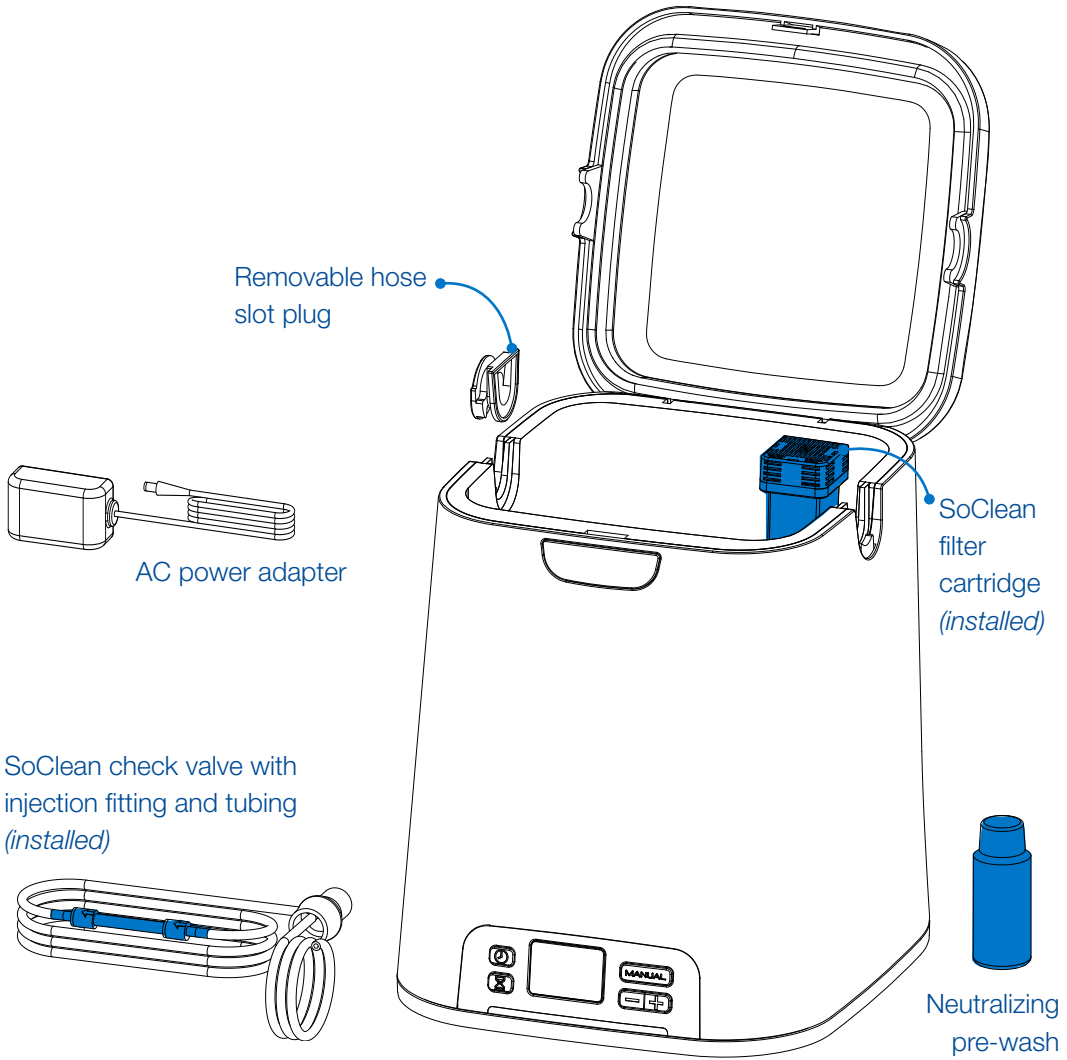

Important Supplies

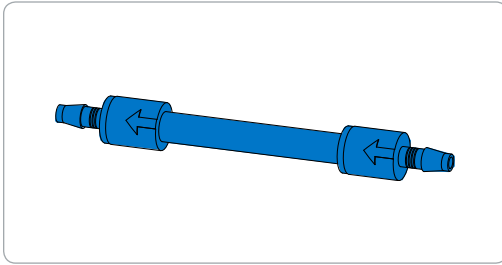

Check Valve (installed)

Prevents water in your humidifier reservoir from backing up into your SoClean machine. If you can see water in the clear tube, replace the check valve assembly immediately.

Replace every 6 months, or when the SoClean display shows the “Order Filter Kit” message.

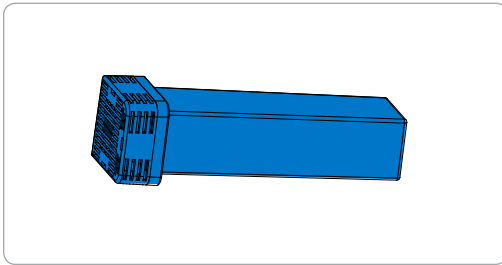

Filter Cartridge (installed)

This filter converts activated oxygen back into normal oxygen.

Replace every 6 months, or when the SoClean display shows the “Order Filter Kit” message.



Neutralizing Pre-Wash

Fragrance-free hypoallergenic cleaning solution. The pre-wash neutralizes any pre-existing odors from detergents, and removes any residue from the manufacturing process that could react with activated oxygen. Use the pre-wash whenever you hand wash your PAP equipment. Alternatively, you may use any other fragrance-free, dye-free dish soap.

Understanding Your PAP Machine

The SoClean is designed to connect to your PAP machine. This manual references some of the individual components of your PAP machine. Please use the diagram below to familiarize yourself with these terms before proceeding.

Please note that there are many types of PAP machines. This diagram is for example reference only.

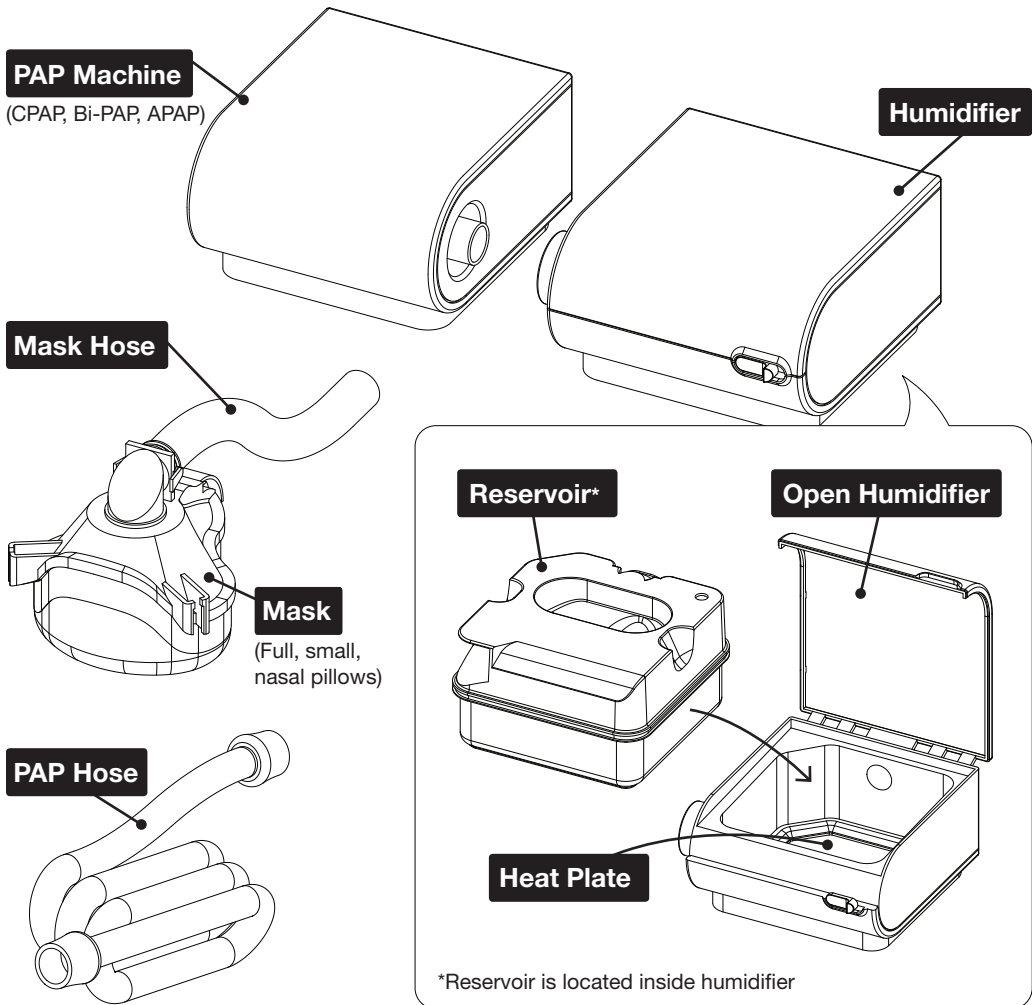

Getting Started

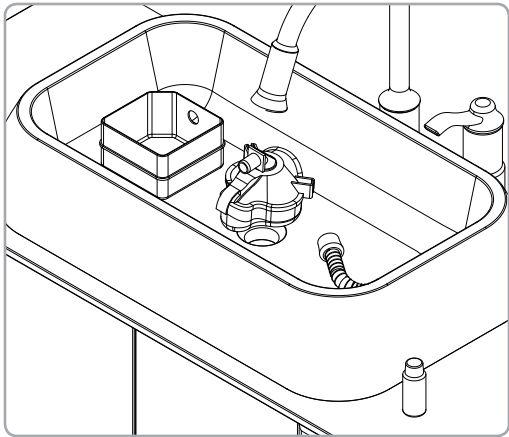

1. Pre-washing your PAP Equipment

Use two capfuls of the included pre-wash with a gallon of water to wash your PAP equipment (mask, hose, and reservoir), then rinse thoroughly with clean water.

Note: The SoClean 2 uses no fluids in its operation. The pre-wash is supplied for hand washing your PAP equipment only. DO NOT immerse your SoClean in water.

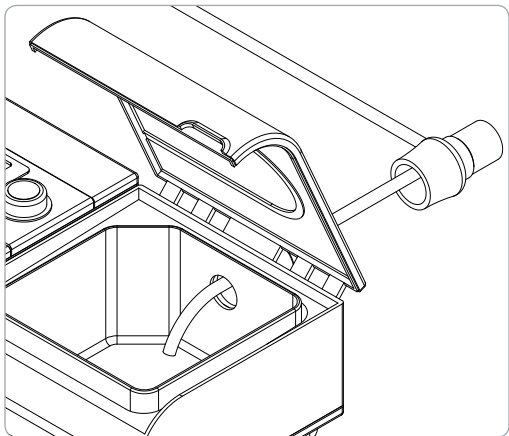

2. Installing the Injection Fitting

The injection fitting connects the SoClean to your PAP machine. Once installed, you do not need to disconnect the injection fitting to use your PAP. You may leave the SoClean connected to your PAP. If you need instructions for connecting to your specific PAP model, please visit our website www.BetterRestSolutions.com.

With humidifier: Disconnect your PAP hose from your PAP machine. Position the injection fitting onto the port of your humidifier, allowing the smaller tubing to enter into the reservoir. The end of the tubing should rest on or near the bottom of the tubing, over the heat plate. If necessary, carefully trim the injection tubing in increments until it is the correct length.

continued ... Getting Started

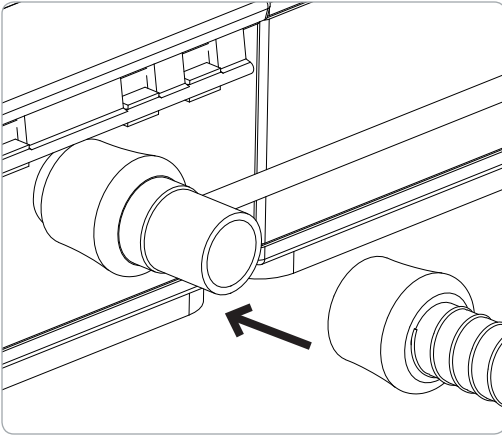

Now connect your PAP hose to the end of the injection fitting.

You may operate the SoClean with or without water in the humidifier reservoir. The SoClean will disinfect any water in the humidifier reservoir as long as the end of the injection tubing rests on or near the bottom of the reservoir, and below water level.

Note: Different reservoirs may require different approaches to hose insertion. If you have difficulty, visit www.BetterRestSolutions.com for information on various humidifier models, or contact Better Rest Solutions directly at 1(866) 501-3705.

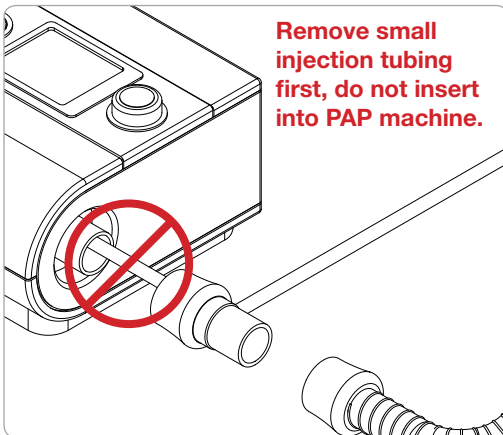

Remove small injection tubing first, do not insert into PAP machine.

Without humidifier: If you are currently not using a humidifier, remove the short length of black tubing from the inside of the injection fitting by pulling it straight off, and then attach the fitting directly to your PAP machine. Reconnect your PAP hose to the end of the injection fitting. Depending on the style of your reservoir, you may need to disconnect the fitting to add water to your reservoir.

If you regularly use your PAP without the reservoir attached, please contact Better Rest Solutions to receive a modified injection fitting (PN1116) at no charge. You may call 1(866) 501-3705 or email support@betterrestsolutions.com.

If you need help connecting to your specific machine, please visit our support pages at www.BetterRestSolutions.com/support/soclean-support/

Getting Started ... *continued*

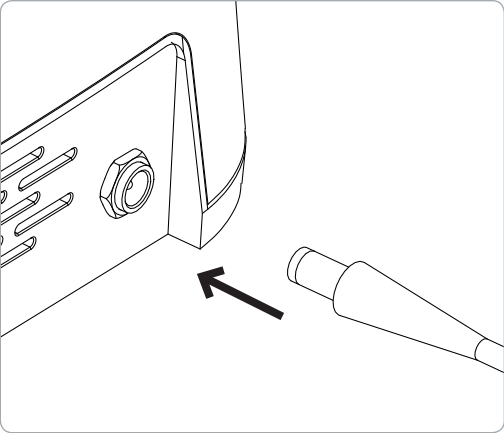
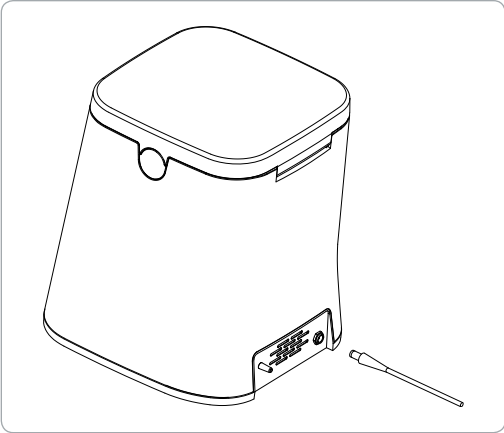
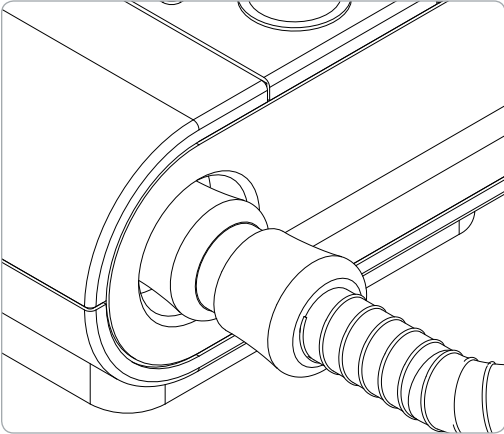
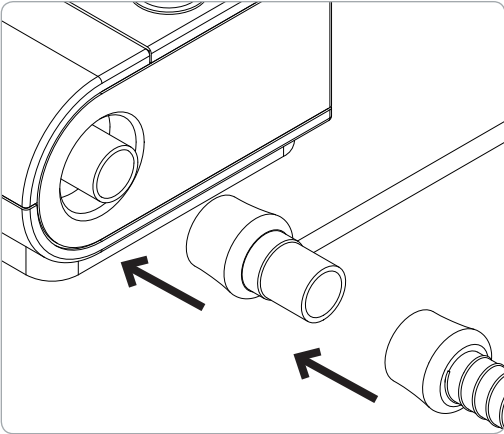

3. Power Up

Plug your AC adapter into the back of the SoClean and then into a wall outlet. Proceed to set your timer.

Your SoClean Timer & Display

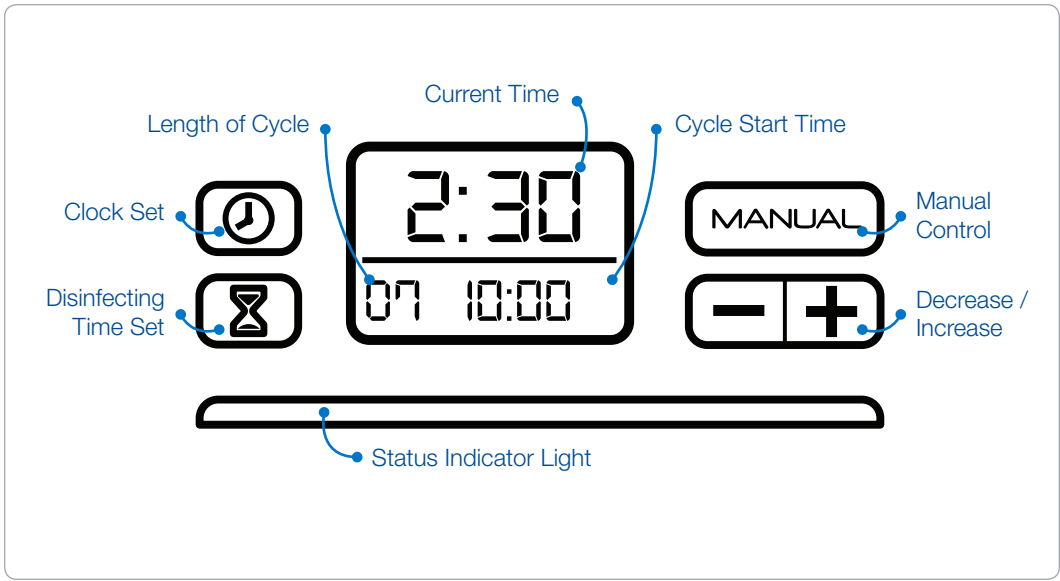

Your SoClean timer will allow you to completely automate your daily cleaning. The SoClean comes preset to start a 7 minute cleaning cycle at 10:00 am. First set the clock to match your current time. You can easily change these settings by following the steps on the next pages.

If you unplug the SoClean or experience a power loss, you will need to reset the current time only. The disinfecting settings will remain saved. For safe use, operate your SoClean only as instructed in this guide.



Your SoClean Timer & Display ... *continued*



Setting the Clock

Press the  button.



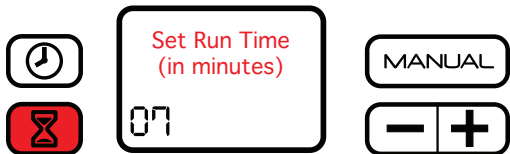

Change the time by pushing either the  or  button until your current time is reached. By holding down the button the time moves faster. Press the  button once more to store your time and return to the home screen.

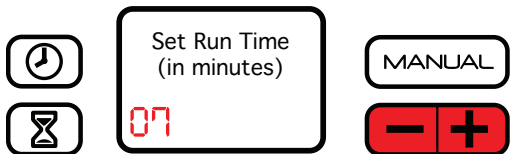

Setting the Run Time and Duration

Press the  button.



Press the  or  button to decrease or increase the number of minutes of your run time.



Note: A run time of 5 to 10 minutes should be enough to completely disinfect your equipment.

continued ... Your SoClean Timer & Display



Press the  button again and you will be prompted to set the time of day you would like to run your SoClean.



Use the  or  button to reach the desired time. Press the  button once more to store your settings and return to the home screen.





Manual Mode



For those times when you wish to disinfect your equipment other than during your scheduled cycle, simply place your mask inside the SoClean like you normally would and press the  button. The SoClean will then operate according to your preset run time. Your timer settings will not be affected. As with your normal disinfecting procedure, wait for the green light before removing your mask. For questions about the status indicator light, please see the FAQ on page 18.



24-Hour Clock

If you prefer your clock to display in the 24-hour format (military time), press the  and  buttons simultaneously. You will then be prompted to choose either the 12 or 24 hour format. Use the  button to select the clock format. The press the  button to save your setting.

Your SoClean Timer & Display ... *continued*

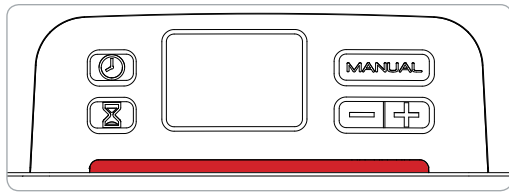

Cycle Indicator Light

The lighted bar below the clock display indicates the status of the SoClean.

RED when the SoClean is operating and generating activated oxygen.

YELLOW when the SoClean is in its 2-hour disinfecting cycle.

GREEN when disinfecting has been successfully completed.

The lighted display will turn off once the lid is lifted. For questions about the status indicator light, please see the FAQ on page 18.

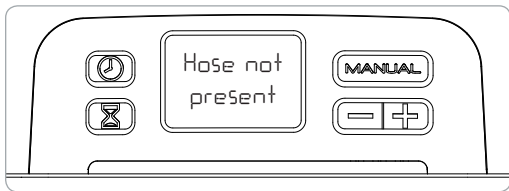

Display Messages

Hose not present. Cycle will not run:

This message displays during the manual mode when there is no mask and hose in the SoClean, the lid is not properly closed, or the hose slot plug is missing or improperly seated.

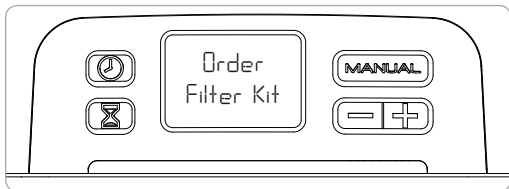

Order filter kit: This message displays after approximately 6 months of use as a reminder to order a replacement filter and check valve kit.

Using Your SoClean

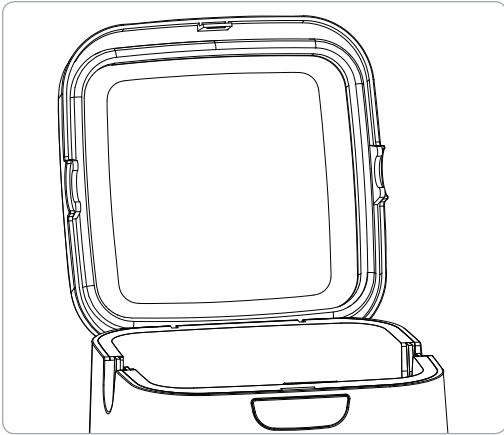

After the initial setup, using your SoClean unit is extremely easy. You will not need to disassemble any components to disinfect your equipment daily.

1. Open the lid.

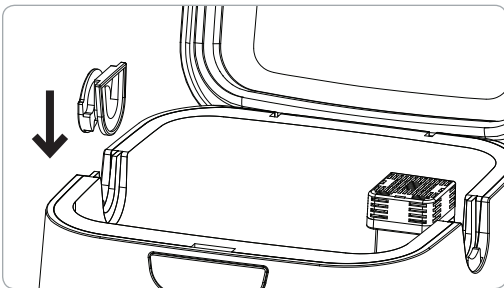

2. Install the removable hose slot plug into one open slot.

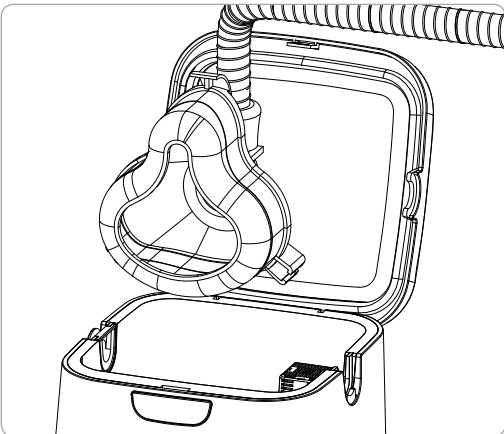

3. Insert your mask into the chamber allowing its attached hose to rest in the open hose slot.

Note: The SoClean gives you the option of inserting your mask and hose from either side of the machine. To change sides, remove the hose slot plug from its position by lifting it straight out, and insert it into the slot on the opposite side.

Using Your SoClean ... *continued*

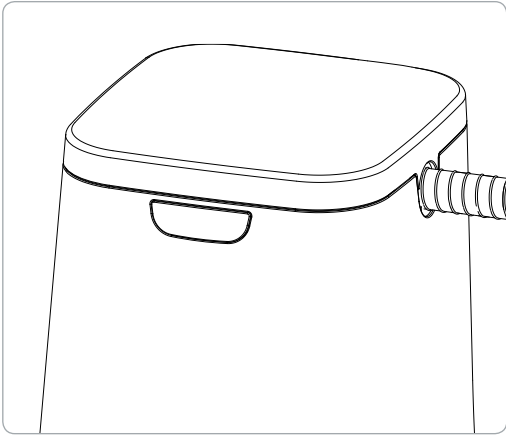

4. Close the lid.

The SoClean will now automatically operate according to its preset time and duration.

Note: The SoClean will never operate without the mask and hose present in the securely closed chamber. Additionally, the SoClean will not operate if the hose slot plug is missing or improperly seated.

Important: Even though the actual run time of the SoClean may only be 5 to 10 minutes, it is necessary to let the mask remain in the closed chamber for at least 2 more hours. After that period, the cycle indicator light will shine green as a sign that all disinfecting is complete and the mask is ready to be removed from the chamber.

5. Once cycle has completed, open the lid, remove mask and removable hose slot plug. Leave slot plug inside SoClean chamber. Store the slot plug inside the SoClean chamber.

Care and Maintenance for your SoClean

You may wipe down the SoClean with a damp cloth.

The SoClean check valve and filter cartridge should be replaced every 6 months. A reminder message on the display will appear after approximately six months, depending on usage.

To reorder supplies, contact your authorized reseller or visit www.BetterRestSolutions.com.

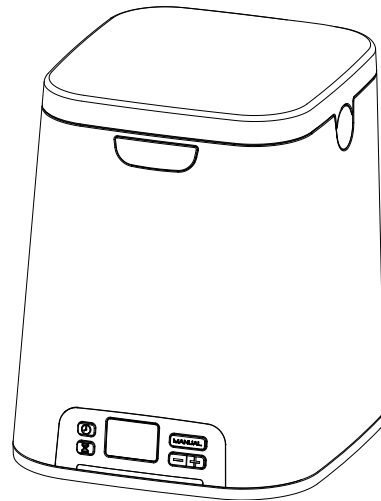

Cartridge Filter Kit - Sold Together

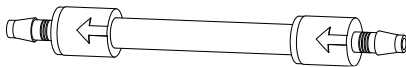

Check Valve

**REPLACE EVERY 6 MONTHS,
OR WHEN THE SOCLEAN
DISPLAY SHOWS THE "ORDER
FILTER KIT" MESSAGE.**

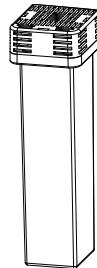

Cartridge Filter

**REPLACE EVERY 6 MONTHS,
OR WHEN THE SOCLEAN
DISPLAY SHOWS THE "ORDER
FILTER KIT" MESSAGE.**

FAQ

1. Will my PAP equipment be wet from the SoClean? No. The SoClean disinfects with activated oxygen. No fluids or water are used in this process.

2. Is the SoClean harmful to me or the environment? No. The SoClean disinfects with activated oxygen. The same sanitizing technology is safely used on produce and drinking water. The SoClean produces activated oxygen in a closed system. The activated oxygen disinfects your equipment and naturally breaks down to regular oxygen within two hours. Additionally, any excess activated oxygen passes through a filter which converts it back to regular oxygen before release.

3. How do I know that my SoClean is disinfecting properly? After the disinfecting process has successfully completed, the status indicator light will shine green. Your PAP equipment will have a light, clean scent.

4. What if the scent the SoClean leaves is too strong for me? First, try washing your equipment with the Neutralizing Pre-wash. If the smell is still strong, you may try any of these steps: (1) Before wearing your mask at bedtime, run your PAP for 20 seconds to allow any residual scent to blow out. (2) Set the timer so that the machine runs earlier in the day, allowing any residual scent to dissipate by nighttime. (3) Increase the cycle duration time up to 12 minutes for a few days, and then reduce the time to your preferred setting. A strong odor usually indicates a high amount of oxidized organics.

5. What if my indicator light is shining red or yellow? This means that the disinfecting process is not yet complete. Please wait until the light shines green to remove your PAP equipment from the SoClean chamber. (See page 14)

6. It has been more than two hours since the SoClean completed a cycle, but the status

light is still yellow. Why? Some types of indoor lighting may make it difficult to distinguish the yellow and green lights on the SoClean. If two hours have passed since the SoClean completed a cycle, your PAP equipment is disinfected and ready for use.

7. What if the indicator light is not shining after a scheduled cleaning time? The SoClean did not complete a disinfecting cycle successfully. Common reasons for this are that the lid was not securely closed, there was no mask in the chamber at cleaning time or the hose slot plug is missing or not properly seated.

8. What if I missed my scheduled disinfecting time, but still wish to disinfect my equipment? You can use the Manual feature to run a cycle. (See page 13)

9. Why does my display say Order Filter Kit? This message appears approximately every 6 months, depending upon usage, as a reminder to regularly replace the filter and check valve. You can purchase the filter and check valve together in a Cartridge Filter Kit. To reorder, contact your authorized reseller or visit www.BetterRestSolutions.com.

10. Are there materials that I should avoid putting into the SoClean? Nylon and natural rubber break down when exposed to activated oxygen. Most manufacturers typically do not use these materials in their reservoirs, hoses, masks or headgear. If you have questions, contact your PAP manufacturer, supplier or Better Rest Solutions.

11. My mask feels oily, what should I do? Skin chemistry is unique. Some individuals with an oily skin type may need to hand-wash the mask occasionally. If you hand-wash your mask, be sure to use the Neutralizing Pre-wash or a fragrance-free, dye-free dish soap.

For further questions or concerns, please visit our website www.betterrestsolutions.com.

Classification, Symbols, FCC Notice

CLASSIFICATION

Class IIa

According to 93/42/EEC MDD Annex IX, Sect III, Rule 15

PAP Disinfecting device

SYMBOLS



Consult Manual



Complies with Medical Device
Directive of the European Union.

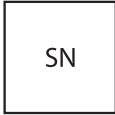

Serial Number



Waste Electrical and Electronic Equipment (WEEE)
It is the responsibility of the end user to dispose of
this equipment at a designated collection point.

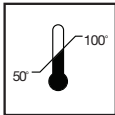

Operating temperature conditions

FCC NOTICE

Please note that changes or modifications not expressly approved by the party responsible for compliance could void the user's authority to operate the equipment.

NOTE: This equipment has been tested and found to comply with the limits for a Class B digital device, pursuant to Part 15 of the FCC Rules. These limits are designed to provide reasonable protection against harmful interference in a residential installation. This equipment generates, uses and can radiate radio frequency energy and, if not installed and used in accordance with the instructions, may cause harmful interference to radio communications. However, there is no guarantee that interference will not occur in a particular installation. If this equipment does cause harmful interference to radio or television reception, which can be determined by turning the equipment off and on, the user is encouraged to try to correct the interference by one or more of the following measures: -- Reorient or relocate the receiving antenna. -- Increase the separation between the equipment and receiver. -- Connect the equipment into an outlet on a circuit different from that to which the receiver is connected. -- Consult the dealer or an experienced radio/TV technician for help.

USER GUIDE

**For more information about
SoClean 2
or our other innovative products, please visit
www.BetterRestSolutions.com**

Copyright © 2011-2014 www.betterrestsolutions.com
Better Rest Solutions is a division of Inceptus
SoClean® is a registered trademark of Inceptus, Inc.
Oxford, MA U.S.A. 01540

Rev.: G