

TVB00

User Guide



Copyright©2011

All Rights Reserved - Printed in Taiwan

Tablet PC User Guide

Original Issue: 2011/02

This manual guides you in setting up and using your new Tablet PC. Information in this manual has been carefully checked for accuracy and is subject to change without notice.

No part of this manual may be reproduced, stored in a retrieval system, or transmitted, in any form or by any means, electronic, mechanical, photocopy, recording, or otherwise, without prior written permission.

Trademarks

Product names used herein are for identification purposes only and may be the trademarks of their respective companies.

Windows 7 home premium, and Windows Sound System are trademarks of Microsoft Corporation.

Intel ® and Intel ® ATOM™ are registered trademark of Intel Corporation.

Sound Blaster, Sound Blaster Pro are trademarks of Creative Technology.

All other brands or product names mentioned in this manual are trademarks or registered trademarks of their respective companies.

FCC Information to User

Safety and Care Instructions

No matter what your level of experience with computers, please make sure you read the safety and care instructions. This information can help protect you and your computer from possible harm.

Important Safety Instructions

This section gives you detailed information about how to maintain a safe working environment while using the Tablet PC. You can maintain its condition and performance by following these guidelines. Please read it carefully to ensure maximum safety.

1. Please read these safety instructions carefully.
2. Please keep this manual for later reference.
3. **Glass Parts** The outside cover of the Tablet PC's screen is made of glass. This glass could break if Tablet PC is dropped on a hard surface or receives a substantial impact. If the glass chips or cracks, do not touch or attempt to remove the broken glass and stop using Tablet PC. Glass cracked due to misuse or abuse is not covered under the warranty.
4. Please keep this equipment from humidity.
5. Do not use this product near water, for example, near a bathtub, wash bowl kitchen sink or laundry tub, in a wet basement or near a swimming pool.
6. Lay this equipment on a reliable surface when install. A drop or fall could cause injury.
7. All cautions and warnings on the equipment should be noted.
8. Do not operate the Tablet PC with the case removed. For safety reason, the equipment should only be opened by qualified service personnel.
9. Always disconnect all telephone lines & all power cords from the wall outlet before servicing or disassembling this product. To reduce the risk of

personal injury from electrical shock or hot surfaces, disconnect the power cord from the wall outlet, and allow the internal system components to cool before touching.

10. Refer your system for servicing to qualified service personal under the following conditions:
 - When the power cord or plug is damaged or frayed.
 - If liquid has been spilled into the product.
 - If the product has been exposed to rain or water.
 - If the product does not operate normally when the operating instructions are followed. Adjust only those controls that are covered by the operating instructions, since improper adjustment of other controls may result in damage and will often require extensive work by a qualified technician to restore the product to normal condition.
 - If the product has been dropped or the cabinet has been damaged.
 - If the product displays a distinct change in performance, it indicates a need for service.
 - If the equipment has obvious sign of breakage.
11. The unit can be operated at maximum ambient temperature of 40°C.
12. Polymer battery is vulnerable, do not charge it with other power adapter, or it may cause fire or explosion
13. This product should be operated from the type of power indicated on the marking label. If you are not sure of the type of power available, consult your dealer or local power company.
14. Use only a power adapter approved for use with this Tablet PC.
15. Do not install near any heat sources such as radiators, heat registers, stoves, or other apparatus (including amplifiers) that produce heat.
16. If the Tablet PC is not in use for a long time, disconnect it from mains to avoid possible damage by transient over-voltage.
17. The risk of ignition caused by small metallic objects, such as paper clips or staples, moving around inside TRANSPORTABLE EQUIPMENT during

transportation shall be reduced objects entering the equipment, please do not remove dummy card from the product.

Installation Restrictions

1. If an extension cord is used with this product, make sure that the total ampere rating of the equipment plugged into the extension cord does not exceed the extension cord ampere rating. Also, make sure that the total rating of all products plugged into the wall outlet does not exceed the fuse rating.
2. Never push objects of any kind into this product through cabinet slots as they may touch dangerous voltage points or short out parts that could result in a fire or electronic shock. Never spill liquid of any kind on the product.
3. Unplug this product from the wall outlet before cleaning. Do not use liquid cleaners or aerosol cleaners. Use a dry cloth for cleaning. Ensure that no liquid enters the system.

Battery (Polymer)

Battery Pack



"Do not incinerate, (or) disassemble; may explode or release toxic materials. Do not short circuit; may cause burns."

Note:

1. The following caution statement is located in the service and operating manual or on the label adjacent to the battery.
2. **Battery Replacement.** The rechargeable battery in Tablet PC should be replaced only by FIC. For more information about battery replacement service, go to: www.fic.com.tw/tycoon Risk of explosion if battery is replaced by an incorrect type.
3. Do not dispose of batteries in a fire.

English

CAUTION: DANGER OF EXPLOSION IF BATTERY IS INCORRECTLY REPLACED. REPLACE ONLY WITH SAME OR EQUIVALENT TYPE RECOMMENDED BY THE MANUFACTURER. DISCARD USED BATTERIES ACCORDING TO THE MANUFACTURER'S INSTRUCTIONS.

French

IL Y A DANGER D'EXPLOSION S'IL Y A REMPLACEMENT INCORRECT DE LA BATTERIE. REMPLACER UNIQUEMENT AVEC UNE BATTERIE DU MÊME TYPE OU D'UN TYPE RECOMMANDÉ PAR LE CONSTRUCTEUR. METTER AU RÉBUT LES BATTERIES USAGÉES CONFORMÉMENT AUX INSTRUCTIONS DU FABRICANT.

German

VORSICHT ! Explosionsgefahr bei unsachgemäßen Austausch der Batterie.Ersatz nur durch denselben oder einem vom Hersteller empfohlenem ähnlichen Typ.Entsorgung gebrauchter Batterien nach Angaben des Herstellers.

Swedish

Explosionsfara vid felaktigt batteritype. Använd samma batterityp eller en ekvivalent typ som rekommenderas av apparattillverkaren. Kassera använt batteri enligt fabrikantens instruktion.

Danish

Lithiumbatteri- Eksplosionsfare ved fejlagtig håndtering. Udskiftning må kun ske med batteri af samme fabrikat og type. Lever det brugte batteri tilbage til leverandoren.

Norwegian

Eksplosjonsfare ved feilaktig skifte av batteri. Benytt samme batteritype eller en

tilsvarende type anbefalt av apparatfabriknten. Brukte batterier kasseres i henhold til fabrikantens instruksjoner.

Finnish

Paristo voi räjähtää, jos se on virheellisesti asennettu. Vaihda paristo ainostaan laitevalmistajan suosittelemaan tyyppiin. Hävitä käyteet paristo valmistajan ohjeiden mukaisesti.

Power Adapter



For indoor use only.



For use with information technology equipment.



Risk of electric shock do not open.

Power Cord Set Requirements

- An approved power cord has to be used.
- Make sure the socket and any extension cord(s) you use can support the total current load of all the connected devices.
- Before cleaning the computer, make sure it is disconnected from any external power supplies (i.e. AC adapter).
- The power cord set (appliance coupler, flexible cord, and wall plug) you received with the Tablet meets the requirements for use in the country where you purchased the equipment.
- Power cord sets for use in other counties must meet the requirements of the country where you use the computer. For more information on power cord set requirement, contact your local authorized dealer, reseller, or service provider.

- Protect the power cord from being walked on or pinched particularly at plugs, convenience receptacles, and the point where they exit from the apparatus.

Federal Communications Commission (FCC) Requirements, Part 15

This equipment has been tested and found to comply with the limits for a class B digital device, pursuant to part 15 of the FCC Rules. These limits are designed to provide reasonable protection against harmful interference in a residential installation.

This equipment generates, uses and can radiate radio frequency energy and, if not installed and used in accordance with the instructions, may cause harmful interference to radio communications. However, there is no guarantee that interference will not occur in a particular installation. If this equipment does cause harmful interference to radio or television reception, which can be determined by turning the equipment off and on, the user is encouraged to try to correct the interference by one or more of the following measures:

- Reorient or relocate the receiving antenna.
- Increase the separation between the equipment and receiver.
- Connect the equipment into an outlet on a circuit different from that to which the receiver is connected.
- Consult the dealer or an experienced radio/TV technician for help.

You may find helpful the following booklet, prepared by the Federal Communications Commission: Interference Handbook (stock number 004-000-00345-4). This booklet is available from the U.S. Government Printing Office, Washington, DC20402

Warning: The user must not modify or change this computer without approval. Modification could void authority to this equipment.

This device complies with Part 15 of the FCC Rules. Operation is subject to the following two conditions:

- (1) This device may not cause harmful interference.
- (2) This device must accept any interference received, including interference that may cause undesired operation.

FCC RF Exposure

FCC RF Radiation Exposure Statement:

Warning: Use the specified shielded power cord and shielded signal cables with this computer, so as not to interfere with radio and television reception. If you use other cables, it may cause interference with radio and television reception.

1. This transmitter has been demonstrated co-location compliance requirements. This transmitter must not be co-location or operating in conjunction with any other antenna or transmitter.
2. This equipment complies with FCC RF radiation exposure limits set forth for an uncontrolled environment. This device was tested for typical lap held operations with the device contacted directly to the human body to the back side of the notebook computer. To maintain compliance with FCC RF exposure compliance requirements, avoid direct contact to the transmitting antenna during transmitting.

This equipment complies with FCC RF radiation exposure limits set forth for an uncontrolled environment. This equipment should be installed and operated with a minimum distance of 20 centimeters between the radiator and your body.

15.247 (b)(4), the EUT meets the requirement that it be operated in a manner that ensures the public is not exposed to radio frequency energy levels in excess of the Commission's guidelines (1.1307, 1.1310, 2.1091 and 2.1093)

5.21 Regulatory information/Disclaimers

Installation and use of this Wireless LAN device must be in strict accordance with the instructions included in the user documentation provided with the product. Any changes or modifications (including the antennas) made to this device that are not expressly approved by the manufacturer may void the user's authority to operate the equipment. The manufacturer is not responsible for any radio or television interference caused by unauthorized modification of this device, or the substitution of the connecting cables and equipment other than manufacturer specified. It is the responsibility of the user to correct any interference caused by such unauthorized modification, substitution or attachment. Manufacturer and its authorized resellers or distributors will assume no liability for any damage or violation of government regulations arising from failing to comply with these guidelines.

Shielded Cables Notice

All connections to other computing devices must be made using shielded cables to maintain compliance with FCC regulations.

Peripheral Devices Notice

Only peripherals (input/output devices, terminals, printers, etc) certified to comply with Class B limits may be attached to this equipment. Operation with non-certified peripherals is likely to result in interference to radio and TV reception.

European Notice

For the following equipment: Tablet PC



This device complies with the essential requirements of the R&TTE Directive 1999/5/EC and EMC directive 2004/108/EC. The following test methods have been applied in order to prove presumption of conformity with the essential requirements of the R&TTE Directive 1999/5/EC and EMC directive 2004/108/EC:

The equipment was passed. The test was performed according to the following European standards:

EN 300 328-2 V.1.7.1 (2006)

EN 301 489-17 V2.1.1: 2009 and EN 301 489-1 V1.8.1: 2008

EN 300 328 V1.7.1: 2006

EN 62311 : 2008

EN 60950-1: 2006

EN 55022: 2006 +A1: 2007

EN 61000-3-2 : 2006

EN 61000-3-3 : 1995 + A1 : 2001 + A2 : 2005

EN 55024: 1998 + A1: 2001 + A2: 2003

802.11b and 802.11g Restrictions:

- European standards dictate maximum radiated transmit power of 100mW EIRP and frequency range 2.400-2.4835GHz;
- In France, the equipment must be restricted to the 2.4465-2.4835GHz

frequency range and must be restricted to indoor use."

VCCI instruction

この装置は、クラスB情報技術装置です。この装置は、家庭環境で使用することを目的としていますが、この装置がラジオやテレビジョン受信機に近接して使用されると、受信障害を引き起こすことがあります。

取扱説明書に従って正しい取り扱いをして下さい。 VCCI-B

About Your Tablet PC



Congratulation for having purchased your Tablet PC. This tablet PC can go anywhere you go. Use it like a pad of paper. You can write, sketch, and view material directly on the screen.

About Your User Guide

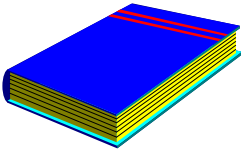

Welcome to your Tablet PC User Guide. This manual gives you the information you need to maximize the use of your Tablet PC. Read this guide to familiarize yourself with this Tablet PC and its features.

This manual is divided into eight chapters.

- Chapter 1 Introduction
- Chapter 2 Getting Started
- Chapter 3 Using Your Tablet PC
- Chapter 4 Connecting External devices
- Chapter 5 Caring for Your Tablet PC

Table of Contents

ABOUT YOUR TABLET PC	13
ABOUT YOUR USER GUIDE.....	14
1 INTRODUCTION.....	17
1.1 FEATURE HIGHLIGHT	18
1.2 THE FRONT VIEW OF THE TABLET PC.....	19
<i>Tablet PC LED Status Indicator.....</i>	<i>21</i>
1.3 THE RIGHT PANEL OF THE TABLET PC.....	22
1.4 THE LEFT PANEL OF THE TABLET PC	25
2 GETTING STARTED	29
2.1 CONNECTING THE AC POWER SOURCE.....	30
2.2 STARTING YOUR TABLET PC.....	31
<i>Turning on the Tablet PC</i>	<i>31</i>
<i>Using the touch screen</i>	<i>32</i>
2.3 DEVICE DRIVERS INSTALLATION	32
<i>Installing Windows 7 from Optical Disk Drive.....</i>	<i>33</i>
<i>Installing all the Device Driver</i>	<i>33</i>
3 USING YOUR TABLET PC.....	35
3.1 SCREEN HOTKEY UTILITY FOR FUNCTION CONTROLS	36
<i>Special Function Control.....</i>	<i>36</i>
<i>About Screen Rotation.....</i>	<i>39</i>
3.2 CONFIGURING YOUR SCREEN DISPLAY.....	40
<i>Possible Display Configurations.....</i>	<i>40</i>
4 CONNECTING TO PERIPHERALS	43
4.1 USING THE USB PORT	44

4.2	USING AN EXTERNAL MONITOR PORT	45
4.3	USING THE EXTERNAL AUDIO SYSTEM.....	46
4.4	USING THE WIRELESS LAN	48
5	CARING FOR YOUR TABLET PC.....	49
5.1	CLEANING YOUR TABLET PC	50

1 Introduction

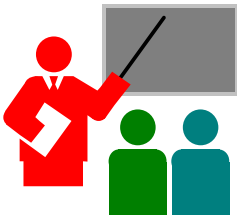

Your Tablet PC is a very thin light-weight designed for mobility, it is a natural traveling companion. With your Tablet PC, you can access office networks and e-mails at anytime, from any location.

Your Tablet PC makes an ideal choice for use in the schoolroom, at home, on the road and all other occasions.

1.1 Feature Highlight

Before we go to identify each part of your Tablet PC, we will first introduce you to other notable features of your Tablet PC.

Processing Unit

- Your tablet runs on Intel® Atom™ N455 Processor that is integrated with 512KB L2 Cache.
- Fully compatible with an entire library of PC software based on operating systems such as Windows 7 Home premium.

Memory

This tablet PC provides one memory slot for installing DDR3-667 SDRAM 204-pin SODIMM modules up to 2GB.

Touch-enabled Widescreen

Provides extraordinary 10.1" 1024 x 600 (16:9) wide screen display with capacitor for your work field at your fingertips.

WiFi

IEEE 802.11 b/g/n, half size Mini Card with USB and PCI-E interface.

Bluetooth

Provides Bluetooth function with USB 2.0 Interface.

Webcam

Provides Webcam function with 2.0M pixels.

Graphic System

Provides blazing graphics controller embedded with Intel NM10 PCH/Intel Atom N455 Processor.

USB 2.0

Provides two USB2.0 ports for I/O data transmission.

Audio System

Compliant with Intel HD Audio (Azalia 2 channels)

Serial ATA (SATA) Controller

Supports data transfer rates of up to 3.0 GB/s (300MB/s)

Flash BIOS

Flash BIOS allows you to easily upgrade the System BIOS using the Phoenix Flash utility program.

Power and System Management

- Integrated SMM (System Management Mode) on system chipset that shuts down components not in use to reduce power consumption. To execute power management, you can set up the parameter in Power Options properties by pointing your mouse to Control Panel of Windows.
- System Password for User and Supervisor included on the BIOS SETUP Program to protect unauthorized use of your computer.

1.2 The Front View of the Tablet PC

The Tablet PC is compact with features on every side. First, look at the front view of the system. The following sections describe front view features.

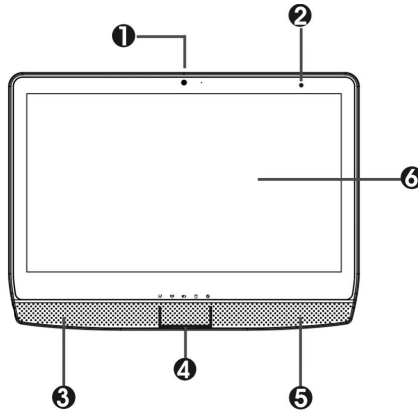

- | | |
|--------------------------------|--------------------------|
| 1. Webcam | 2. Integrated Microphone |
| 3. 5. Built-in Stereo Speakers | 4. LED Indicators |
| 6. Touch screen Widescreen | |

- Webcam
The built-in camera can be used as a communication device for allowing you to capture images, record videos, and have video chats. It is 2.0M pixels and transmitting instant image through network for conference.
- Integrated Microphone
The built-in microphone receives sounds and voices when used with the built-in webcam.
- Built-in Stereo Speakers
Integrated left and right mini stereo speakers for sound and audio output for your multimedia presentations or listening pleasure.
- LED Indicators
Keeps you informed of your Tablet PC's current power status and operating status. Description of the status icons appears in the latter part of this section.

- Touch-enabled Widescreen

This device equipped with touch screen. You may make adjustments to your work field at your fingertips. The touch screen will responsively react with your fingertip commands.

- ▶ 10.1" 1024 x 600 (16:9) wide screen display with capacitor.
- ▶ Capable of displaying 16M colors (32-bit true color) on either size panels.
- ▶ LCD display control allows you to adjust the brightness of the LCD.
- ▶ Simultaneous display capability for LCD and external desktop computer monitor.

TABLET PC LED STATUS INDICATOR

The Status LED Panel keeps you informed of the Tablet PC's current power and operating status. Each LED is marked with an icon to designate the system status.

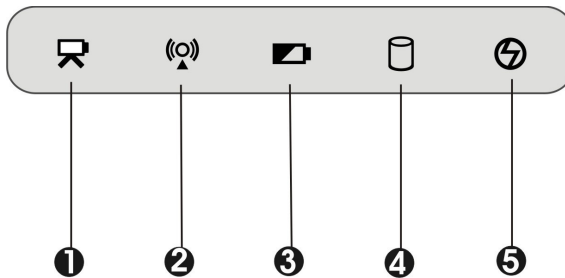

1. Webcam Indicator
3. Battery Charging LED
5. Power Indicator

2. WiFi/bluetooth Access
4. Drive Access

- Webcam Indicator

When LED turns on in white light indicates that the Webcam module is

activated. When LED lights off, it indicates that the function is disabled.

- WiFi/bluetooth Access

When LED turns on in white light indicates that the WiFi/bluetooth accessing is activated. When LED lights off, it indicates that the function is disabled.

- Battery Charging LED

Lights to indicate battery charging status.

- ▶ Lights blinking white indicates that the battery is in charging.
- ▶ Lights amber when the battery is discharged.
- ▶ Lights blinking amber when the battery is low.
- ▶ Lights white indicates the battery is fully charged.

- Drive Access

When LED in white light indicates that the system is accessing the Hard Disk Drive.

- Power Indicator

Lets you know that system is turned on.

- ▶ Lights on when the system is powered on.
- ▶ Lights blinking when the system is in Standby mode.

1.3 The Right Panel of the Tablet PC

The system ports at the right panel of your Tablet PC can connect various devices. Each port is described as followings. Before using the IO port, please open the cover first.

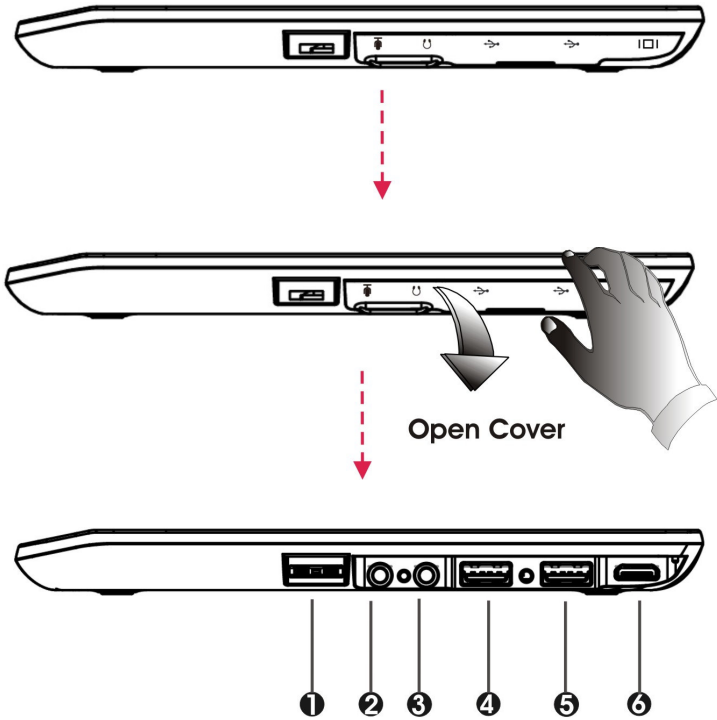

- 1. Three-direction Switch
- 3. Headphone Jack
- 5. USB 2.0 Port

- 2. Microphone Jack
- 4. USB 2.0 Port
- 6. VGA Port

- Three-direction Switch

This switch can let you browse the contents with sliding this switch up or down, then press switch for carriage.

Moreover, when you press Three-direction Switch over 4 seconds, the function is as holding the <Ctrl>+<Alt>+ Keys simultaneously to appear secure logon as listed below for executing the program to perform specific utility.

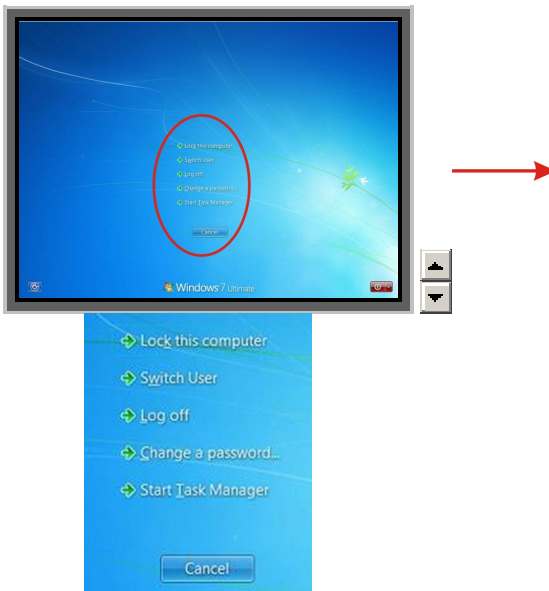

- Microphone Jack

Allows you to connect an external microphone for monophonic sound recording directly into your Tablet PC.

- Headphone Jack

Lets you plug in a stereo headphone, powered speakers, or earphone set with 1/8 inch phone plug for personal listening.

- **USB 2.0 Ports**
The Universal Serial Bus (USB) port allows you to connect USB 2.0-compliant devices (for example, printers, scanners and so on) to your Tablet PC.
- **VGA Port**
Lets you attach an external monitor or projector via VGA switch cable for wider display. You can run the LCD display and the external monitor simultaneously or switch it to monitor only using the hotkey utility control on the screen.

1.4 The Left Panel of the Tablet PC

The left panel of your Tablet PC provides the features shown in the following figure.

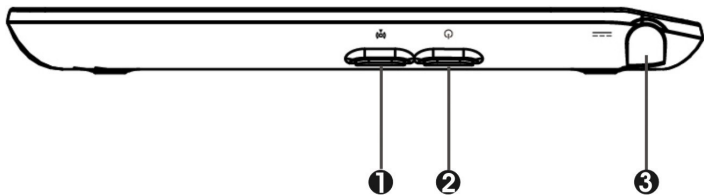

1. WiFi/Bluetooth Button
2. Power On/Resume Button
3. DC Power Port

- **WiFi/Bluetooth Button**
Press this button to enable the WLAN/Bluetooth utility, the screen appears WLAN and Bluetooth functions for your selection. Press the WLAN or Bluetooth to green or gray for activating or inactivating the quick accessing function.



Activate both the WLAN and Bluetooth functions.



Close both the WLAN and Bluetooth functions.



Close the Bluetooth function



Close the WLAN function

- **Power On/Resume Button**
Switches the computer power on and off, or resumes whenever it is in Suspend mode.
- **DC Power Port**
Lets you connect the AC power adapter in supplying continuous power to your Tablet PC and recharging the battery.

2 Getting Started

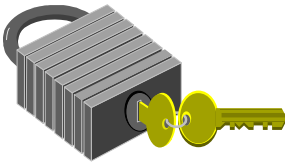

Your Tablet PC is designed and pre-configured for easy setup and use. This chapter describes the installation steps you should follow to get the Tablet PC up and running as quickly as possible.

2.1 Connecting the AC Power Source

The AC adapter provides external power source to your Tablet PC and charges the internal a Lithium-Ion (Li-Ion) battery pack at the same time. The AC adapter also has an auto-switching design that can connect to any 100VAC ~ 240VAC power outlets.

To connect the power adapter:

1. Plug the AC power cord into the power socket of the AC power adapter.
2. Plug the other end of the AC power cord to a live AC wall outlet.

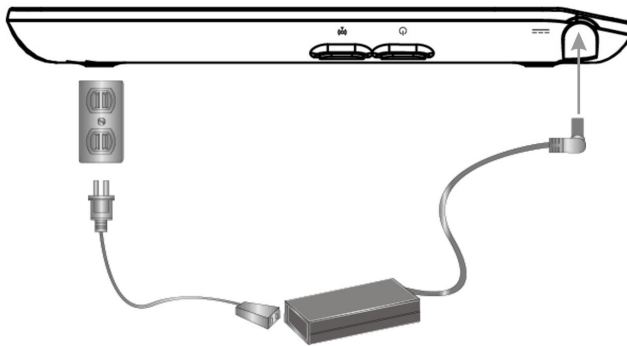

3. Plug the connector of the AC adapter to the DC-IN port found at the left side of the Tablet PC.

NOTE *Whenever possible, it is advisable to always have the AC adapter connected to the Tablet PC. This ensures continuous power supply and prevents any data loss incurring from sudden power breakdown.*

- *For the power supply of this equipment, an approved power cord has to be used.*
- *Make sure the socket and any extension cord(s) you use can support the total current load of all the connected devices.*
- *Before cleaning the computer, make sure it is disconnected from any external power supplies (i.e. AC adapter).*

2.2 Starting Your Tablet PC

TURNING ON THE TABLET PC

The Power/Resume button is found on the left panel of the Tablet PC. Press the Power/Resume button to start your computer and check that if the Power LED turns on.

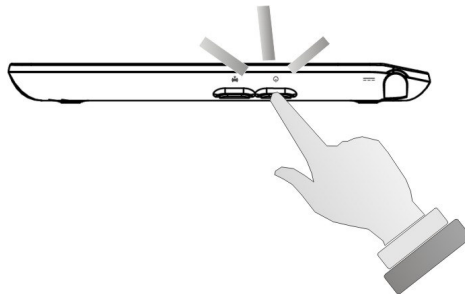

After a few seconds, the computer's display will turn on and your computer will begin to execute the Power On Self Test or POST to check if all system components are running properly. Any error found during the test will be displayed on the screen.

After the test, the screen will also display a message "**press <F2> to enter SETUP**". You don't need to run this program at the moment as your dealer already made the necessary settings for your computer optimal operation. Refer to Chapter 5 on running the SETUP program later.

After the test has completed, your computer will start to search and boot up the operating system from your hard drive. The computer normally comes with a Windows operating system pre-installed in your hard drive. Consult the Windows manual on how to use the program. If not, contact your dealer for assistance.

USING THE TOUCH SCREEN

Your computer is equipped with a touch screen which has a high sensitivity level. You can control your PC with the touch of your finger. Your fingertips work as the hand-held mouse pointer. When you control the computer with your fingertips on the screen, the hand-held mouse can work concurrently.

 *Do not apply pressure on the front of the display or around the screen borders to avoid damaging the touch screen. For more details about maintaining and cleaning the display screen, please see 6.3 Maintaining and Cleaning the Display Screen.*



2.3 Device Drivers Installation

If you already have an operating system installed into your tablet computer, it is best to install the needed device drivers for using the built-in devices of your computer. Before installing the drivers, check with your dealer first if they have already installed all the drivers along with the operating system. If not, follow the procedures below:

INSTALLING WINDOWS 7 FROM OPTICAL DISK DRIVE

To install Windows 7 Home Premium directly from your USB - Slim Combo Drive (optional), please go to **Boot** menu of **BIOS** setup menu. Use arrow key to select "**USB CDROM**", then use "**↑**" or "**↓**" to move it to the top. Go to **Exit** menu and select "**Exit Saving Changes**". Accordingly, insert the Windows 7 Home Premium installation DVD into USB - Slim Combo Drive (optional) with following the instructions on the screen to finish the installation.

Driver Installation Note:

-  *Before installing driver & utility , please turn off "User Account Control settings" item of User Accounts in Control Panel.*
-  *Please install chipset driver first.*
-  *Before installing utility , please install Utility Program Component driver first .*

INSTALLING ALL THE DEVICE DRIVER

1. Click the **Start** button, then point to **Run**. The **Run** dialog box appears.
2. Click the **Browse** button and specify the directory as listed table below, follow the on-screen instructions to complete drivers installation.

Device Driver	Driver Path
Chipset Device Driver	
	"E:\Win7\x86\Chipset\Setup.exe"
VGA Device Driver	

	"E:\Win7\x86\VGA\Setup.exe"
Audio Device Driver	
	"E:\Win7\x86\Audio\Setup.exe"
Utility Program Component Device Driver	
	"E:\Win7\x86\Utility Program Component \Setup.exe"
Hotkey Utility	
	"E:\Win7\x86\Hotkey\setup.exe"
AzureWave WLAN/BT Device Driver	
	"E:\Win7\x86\WLAN+BT\setup.exe"
AzureWave Wireless LAN Device Driver	
	"E:\Win7\x86\Wireless Lan\setup.exe"
AzureWave HD Video Device Driver	
	"E:\Win7\x86\HD Video\setup.exe"
AzureWave Camera Device Utility	
	"E:\Win7\x86\CameraUtility\setup.exe"
HannStar Touch Panel Device Utility	
	"E:\Win7\x86\HID Calibration\HID_GUI_V1.exe"

3 Using Your Tablet PC



This chapter describes how to operate the standard built-in features of the Tablet PC that you normally would use in your day-to-day computer work. If you are new to computers and to your operating system, you also need to read the manual for the operating system on how to work with your Tablet PC. It is very important to familiarize yourself well with the operating system. The succeeding chapters not only guide you to go beyond the basics, but also try other exciting features.

3.1 Screen Hotkey Utility for function controls

Your Tablet PC has a number of function controls on the screen for preprogrammed with special functions. Please just position your finger on the screen where you want to execute a command.

SPECIAL FUNCTION CONTROL

This Tablet PC provides you the hotkey utility on the screen for executing special function as follows:

1. Double click the hotkey utility by finger to appear the function bar.

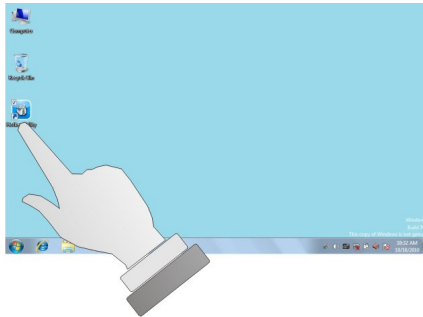

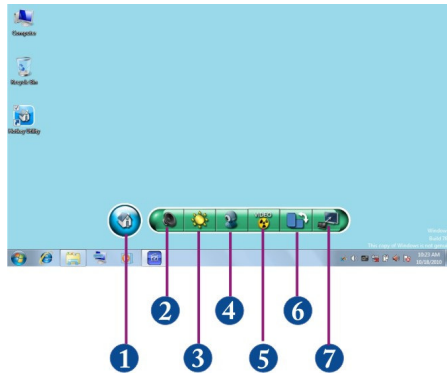

- | | |
|------------------|--------------------|
| 1. Show Desktop | 2. Volume |
| 3. Brightness | 4. Webcam |
| 5. Video Decoder | 6. Screen Rotation |
| 7. VGA Output | |

- Show Desktop
To hide the Wizard from view on the screen, press the button for minimization the Wizard to the task bar.
- Press the Volume command to adjust the audio volume, the Volume adjustment bar appear for you to increase or decrease the audio volume incrementally.

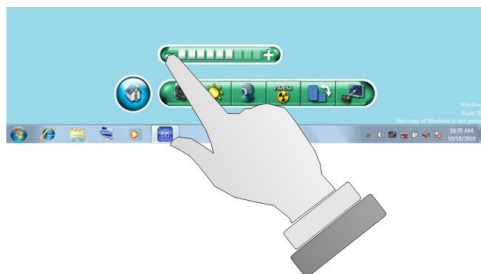

- Press the Brightness command to adjust the screen's brightness, the Brightness adjustment bar appear for you to increase or decrease the display brightness incrementally.

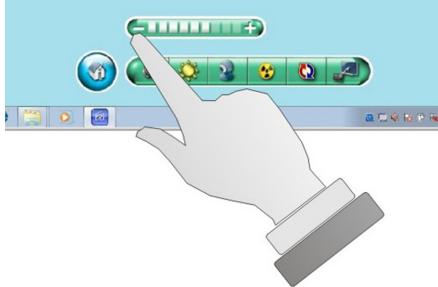

- Press the Webcam command to enable or disable the Webcam function.
- Press the Video Decoder command to enable or disable the video decoder function.
- Press the Screen Rotation command to activate or close the screen rotation function.
- Press the VGA Output command to pop-up the selection bar for choosing the display mode within following four options.
 - ▶ **Computer only:** press this command to display on the Tablet screen only.
 - ▶ **Duplicate:** press this command to display the same contents both on the Tablet screen and external display device. The resolution on these two display modes are same, it is not available to adjust the resolution on the external display mode.
 - ▶ **Extend:** press this command to display the different contents on the Tablet screen and external display device. You can adjust the resolution on the external display device.

- ▶ Projector only: press this command to display on external projector only.

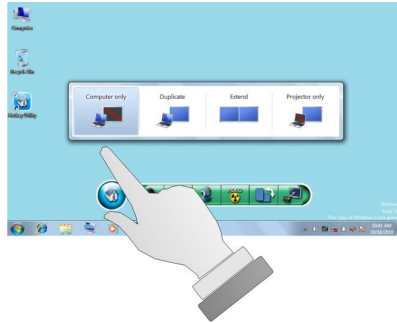

ABOUT SCREEN ROTATION

Tablet PC allows you to view the screen with different orientation but still keep the screen face you. To do so, please position the Tablet PC vertically and rotate it with clockwise 90° each time, the G sensor will recognize the rotation and still keep the screen face you without being rotated accordingly.

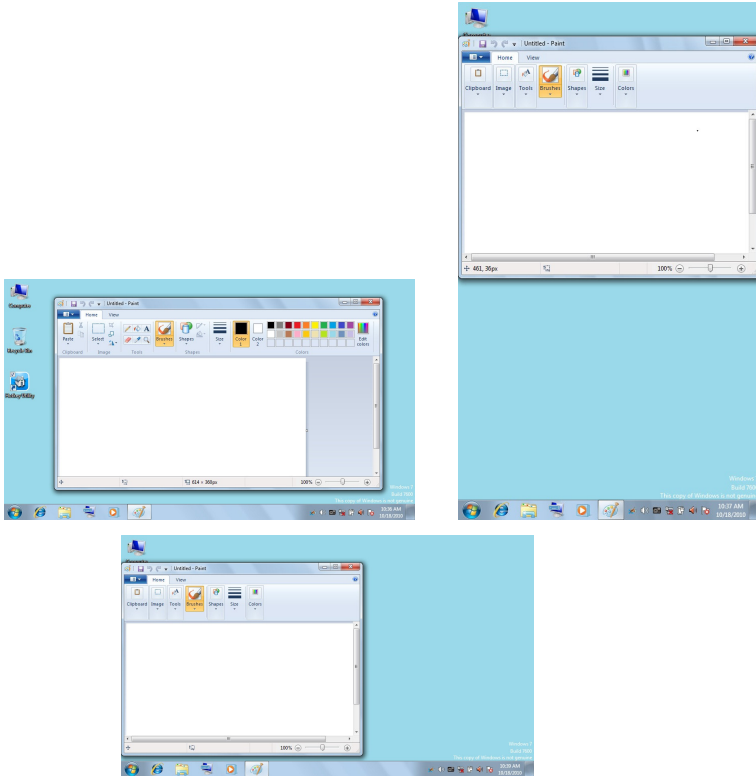

3.2 Configuring Your Screen Display

POSSIBLE DISPLAY CONFIGURATIONS

The table below shows you the possible display resolution you can set when using either the display screen or the external monitor (CRT):

Display	Possible Resolution	Maximum Colors
---------	---------------------	----------------

Widescreen 10.1" WSVGA LCD	1024 x 600	16 million colors
CRT Only	1400 x1050 (Maximum resolution)	16 million colors

☛ *The Panel Resolution with 800x600 will not work with 90-degree. This is the DirectX runtime library limitation from MS.*

☛ *65,536 or 64K colors is also equivalent to 16-bit high color while 16 million or 16M colors is equivalent to 32-bit true color.*

☛ *You can use the hotkey utility on the screen to switch the display within LCD only, CRT only or both LCD and CRT display, simultaneously.*

4 Connecting to Peripherals

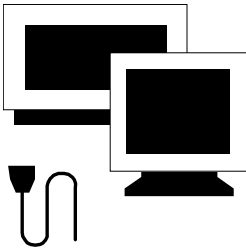

This chapter describes how you attach peripheral devices to your Tablet PC. You can attach a printer or mouse; connect an external monitor and keyboard, or other peripheral device. You will learn how to use these peripheral devices with the step-by-step instructions depicted in this chapter.

4.1 Using the USB Port

USB (Universal Serial Bus) is a hardware interface that enables you to connect multiple devices (such as printers, mice, keyboards, storage devices, digital cameras, and video conference cameras, etc.) to your Tablet PC, and up to 127 devices can be attached. Besides, USB's hot swap capability allows everything to be plugged in and unplugged without turning the system off.

Microsoft, HP, Compaq, Intel, Agere, NEC and Philip are seven core members of USB-IF to have worked on USB 2.0 standardization. USB 2.0 offers data transfer rate up to 480Mbps (megabits per second) compared to USB 1.1 devices, which transfer at speeds of 12Mbps. So, you could know that USB 2.0 can transfer data between the computer and its peripherals 40 times faster than USB 1.1. However, USB 2.0 is fully backward compatible, you will be able to use a USB 1.1 device in a USB 2.0 compliant system.

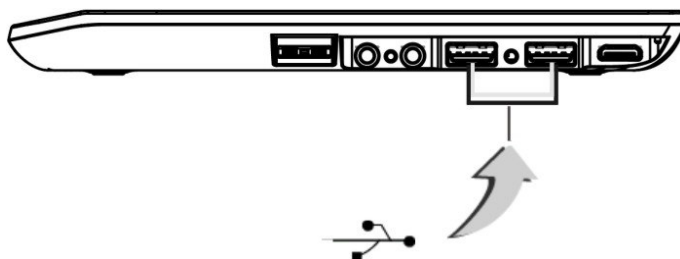

⚠ Depending on your operational requirements, you may need to disable other ports in order to release system resource for the USB port.

⚠ The USB bus distributes 0.5 amps (500 milliamps) of power through each port. For the purpose of power saving, please disconnect your USB device while not in use.

4.2 Using an External Monitor Port

Your Tablet PC has a VGA port switch cable for supporting any external CRT or LCD color monitor. Furthermore, you need a display signal cable (usually provided with the monitor). One end of the cable must have a 15-pin connector for the system.

To connect an external monitor:

1. Turn off your Tablet PC and make sure the monitor power switch is turned off.

 ***The Tablet PC must be powered off or suspended while the monitor is being connected. Although you can connect the external Monitor without power off the computer and the external monitor, however, it is harmful to both devices and it shortens the life of these devices.***

2. Connect the VGA-Output switch cable to the VGA port at the right panel of your Tablet PC.
3. Connect the connector cable of the monitor to the VGA port at the provided switch cable.
4. Connect the monitor power cable and plug it into a properly grounded wall outlet.
5. Turn on the power of the monitor.
6. Turn on your Tablet PC. Both the touchscreen and the monitor screen will show the display. Your computer is set at default to run at simultaneous display mode.

7. If you only want to show the display on the external monitor or projector and shut off the LCD display, you can use the hotkey utility on the screen (for detailed, please refer section 3.2 Screen Hotkey Utility for function controls) to switch display type between LCD and external monitor. Keep pressing the hotkey utility on the screen until you get the display to external monitor only.

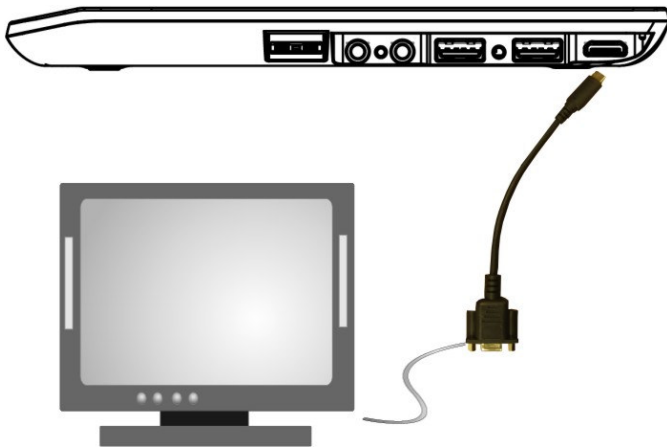

Refer to Chapter 3 regarding the possible External CRT resolutions and how to change the display properties.

4.3 Using the External Audio System

At the right panel of your Tablet PC, you will find the built-in audio ports. You can connect Microphone jacks, earphone or powered speaker.

To connect to an audio jack:

1. Locate the audio port (Microphone, Headphone) that you want to use to the target device.
2. Plug the jack into the port on the right panel of the system.

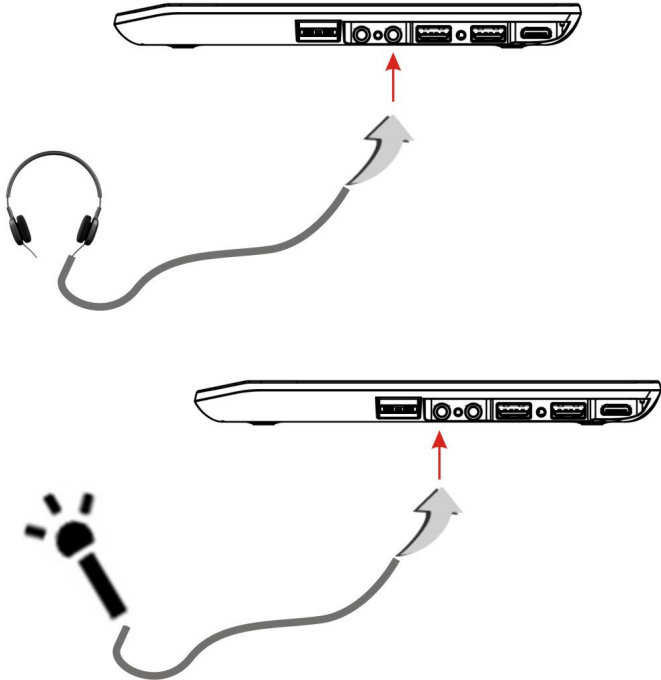

⚠ *If you use external speakers and experience the sound distortion or feedback, please lower the volume. Some factors is caused by too close locating the microphone and speakers from each other, moving away the external audio option from the unit may also help.*

4.4 Using the Wireless LAN

This computer integrates built-in 802.11 b/g/n wireless LAN module. IEEE 802.11b standard supports 11 Mbps wireless connection speed. However, IEEE 802.11g/802.11n supports 54Mbps and 150Mbps wireless connection speed respectively, and is backward compatible with the slower 802.11b.

5 Caring for Your Tablet PC



Your Tablet is equipped with the latest features in mobile computing technology. If properly cared for and maintained, the performance and reliability of the computer can be greatly prolonged.

5.1 Cleaning Your Tablet PC

Your Tablet PC needs occasional cleaning to prolong their life. Please read this section carefully to ensure proper care of Tablet PC. When it is necessary to clean it, use a soft, lint-free cloth, slightly dampened with a mild detergent solution or use the contents of any commercially available computer cleaning kit.

Never use alcohol, petroleum-based solvents, or harsh detergents to clean the tablet. Also never spray any liquids directly on the computer case or screen. If the display screen has become smeared or dusty, clean the screen by first applying a mild glass cleaner to a soft, clean, lint-free cloth, and gently wipe the glass. Never apply liquids directly on the screen surface. Moreover, do not use paper towels to clean the display screen. Paper can scratch the display screen matte.