



EnhanceRAID TS2060 IP

2U 6-disk iSCSI Storage RAID Array for D2D/D2D2T Backup

TS2060 IP

Quick start guide

1 Welcome

Thank you for choosing Enhance Technology

Thank you for buying Enhance Technology TS2060 Series, the ultimate D2D/D2D2T All-in-One backup storage solution designed for high-impact and high-volume real-time data backup and offline archive storage needs.

2 What is in the box?

Carefully unpack your TS2060 storage system, and inventory the accessories according to your model type.

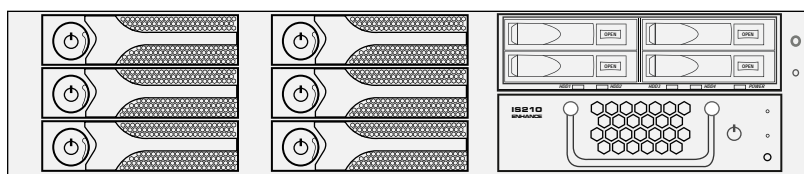

Qty 1 - TS2060 Array with IS210 5.2" HDD Enclosure (optional) & Q14 4x2.5" HDD Enclosure (optional) Installed

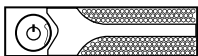

Hot-swap Disk Trays - Qty 6

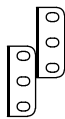

Rack-ear Mounting Kit - Qty 2

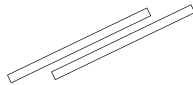

Slide Rail Set - Qty 2

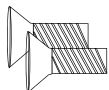

HDD Mounting Hardware - Qty 16

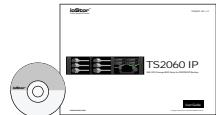

User Guide and CD - Qty 1

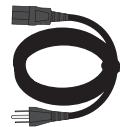

Standard IEC Power Cable - Qty 2

3 Unpack your TS2060

Unpack all components including the HDD mounting screws, key sets and cables. If you are missing any of the items mentioned above, please contact your dealer or contact Enhance Technology at www.enhance-tech.com.

4 Understanding your TS2060

Learn and identify each component of TS2060

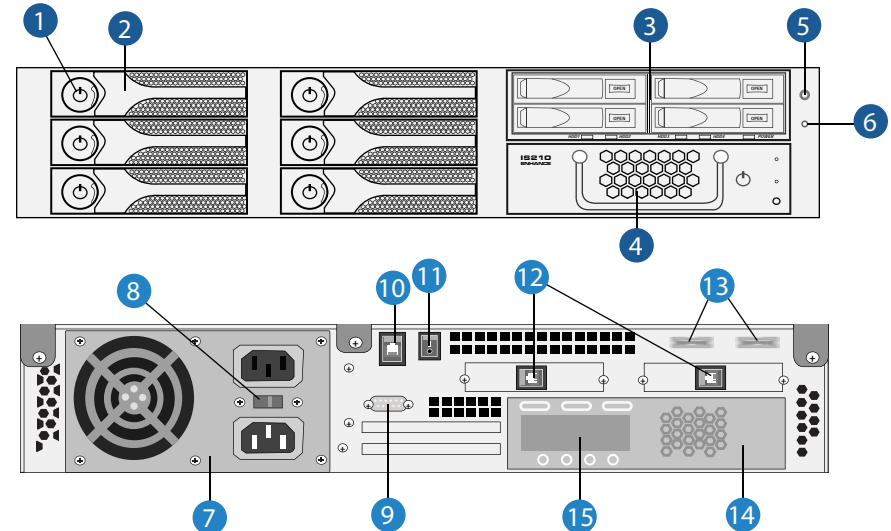

Front:

1. Security Key Lock
2. Hot-swap HDDs Tray
3. Q14 4x2.5" Removable HDDs Enclosure (optional)
4. IS210 5.2" Removable HDDs Enclosure (optional)
5. Power LED
6. Alarm Mute Button

Rear:

7. ATX PS2 Power Supply
8. Auto Power Switch
9. RS232 VT100 ANSI Terminal Emulation
10. Web GUI Management Console
11. Power Switch
12. Dual GbE iSCSI Ports
13. eSATA Ports for IS210 and Q14
14. RAID Controller
15. RAID Controller LED

TS2060 IP

Quick start guide

4 Disk Installation

If your system was purchased with capacity, please skip this section and immediately go to next section. If your system was purchased without disks, install each disk into the provided disk trays and fasten using the supplied hdd screws. Do not use any other mounting screws other than the ones provided with your system. System or disk damage may occur if using non-approved mounting hardware.

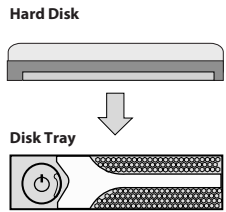

Figure 1.

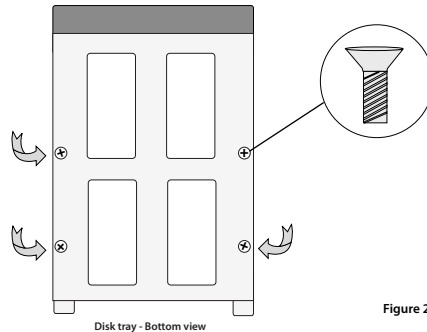

Figure 2.

5 Disk Installation for Q14

If your system was purchased without Q14, please skip this section and immediately go to next section. If your system was purchased with Q14, install each disk into the provided disk trays and fasten using the supplied hdd screws. Do not use any other mounting screws other than the ones provided with your system. System or disk damage may occur if using non-approved mounting hardware.

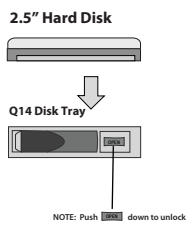

Figure 3.

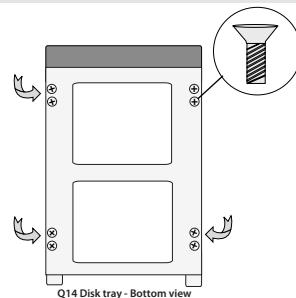

Figure 4.

6 Disk Installation for IS210

If your system was purchased without IS210, please skip this section and immediately go to next section. If your system was purchased with IS210, install disk into the provided disk trays and fasten using the supplied hdd screws. Do not use any other mounting screws other than the ones provided with your system. System or disk damage may occur if using non-approved mounting hardware.

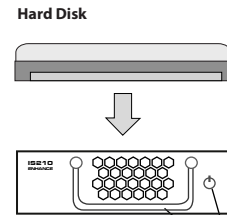

Figure 5.

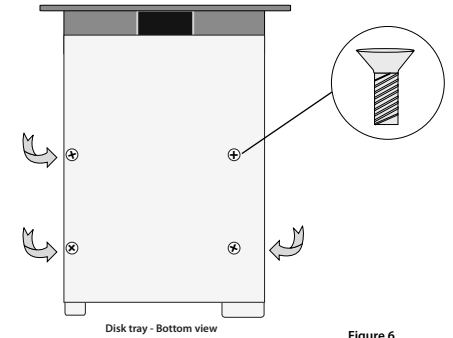
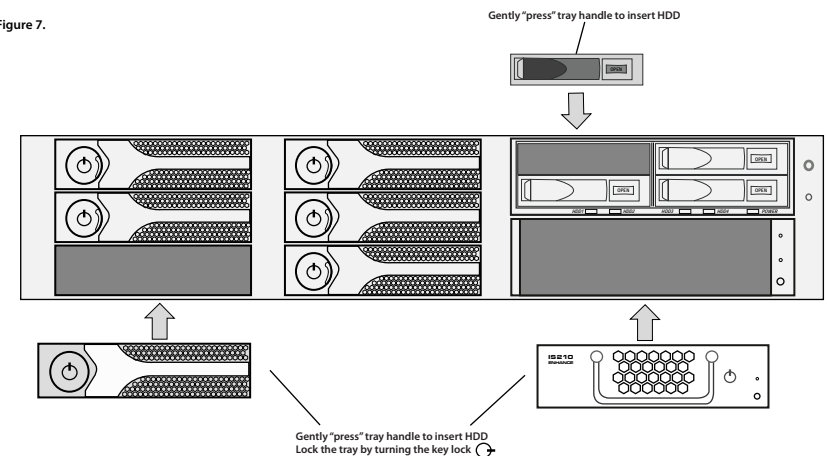

Figure 6.

7 Insert Disk Module

After fastening each disk, insert the disk trays in the open disk bay on your system, Q14 and IS210. For added security, your system is equipped with locking disk bays to prevent accidental or malicious disk removal.

Figure 7.



8

Connecting Your TS2060 - Cable Connections - Option 1

Direct connect to the host computer with iSCSI cables.

Ensure that all of the connectors are properly secured & fastened. Most common issues are related to poor cable connection. Do not force connector into place.

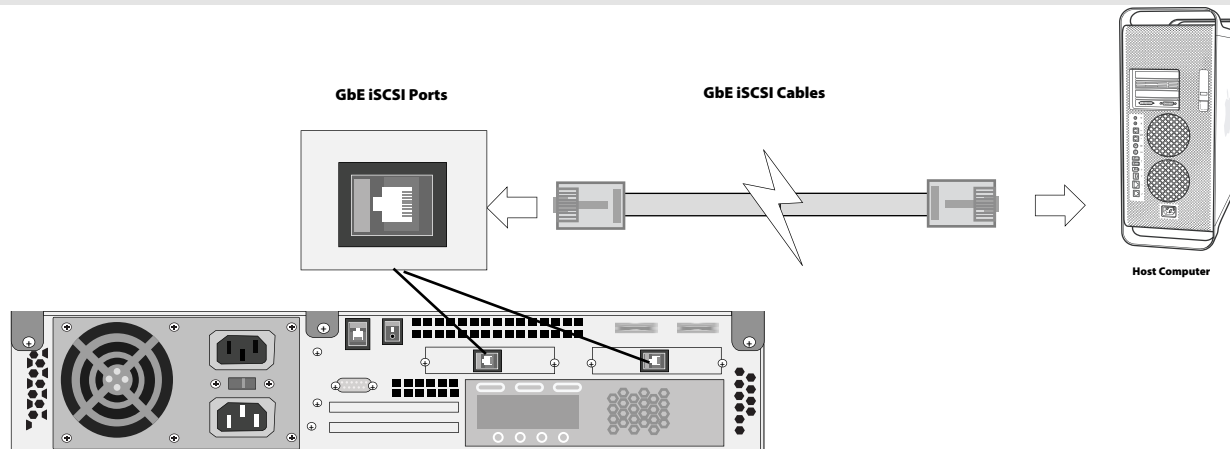

Figure 8.

9

Connecting Your TS2060 - Cable Connections - Option 2

Connect to the host computer via Ethernet Switch with iSCSI cables.

Ensure that all of the connectors are properly secured & fastened. Most common issues are related to poor cable connection. Do not force connector into place.

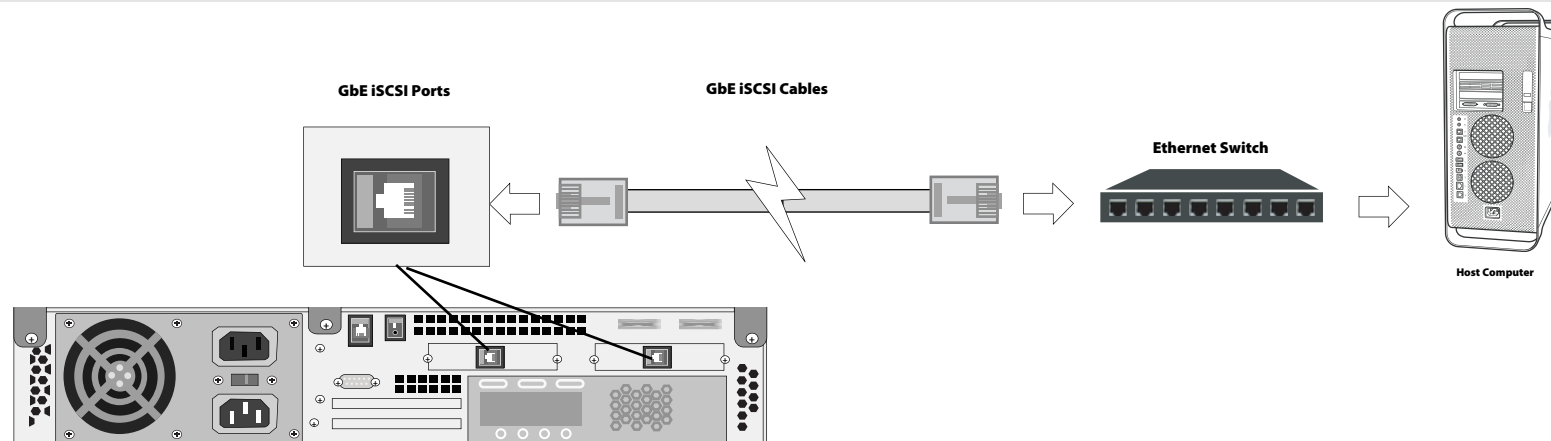

Figure 9.

TS2060 IP

Quick start guide

10 Connecting Your TS2060 - Web GUI Connection

Connect TS2060 Web GUI console to the host computer on the network with cross over cable or connect to the Ethernet switch with LAN cable then power on the system.

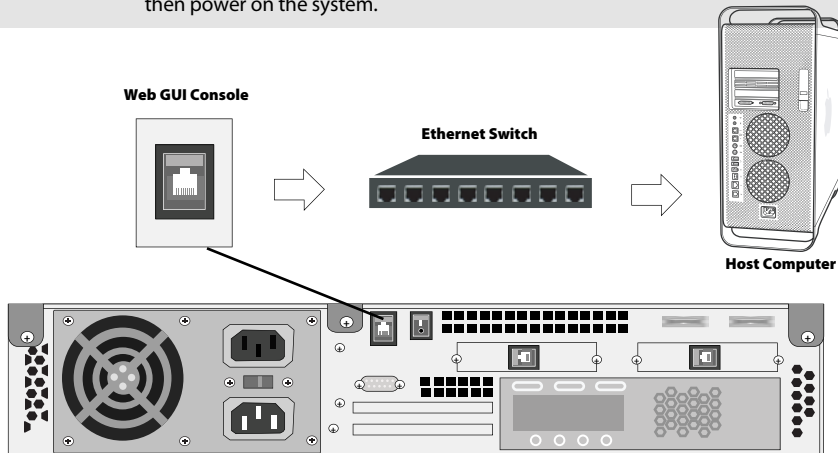

Figure 10.

11 Power On

After connecting both data and Web GUI cables to your system and host computer, power-on your TS2060 first, then power-on your host computer. Your array is now ready for RAID configuration in the Web GUI.

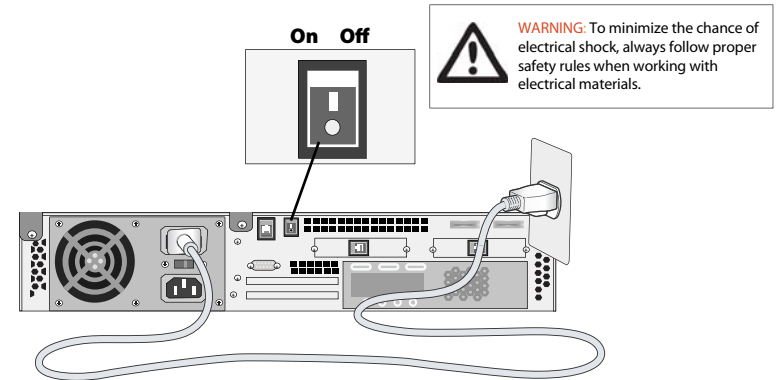
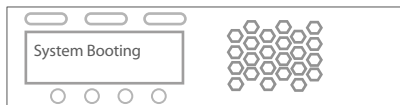

Figure 11.

12 Preparing TS2060 for Configuration

After power-on, the power LED and hard disks LEDs will light up and your TS2060 will display a message showing the system is booting then change to Initializing mode for few seconds to check the system.



1. System is booting up when turn on the power.

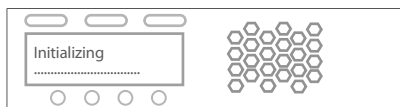

2. RAID controller is initializing the system to check the hardware connection and memory. This is NOT initializing for the hard disks.



3. The system has booted up successfully and showing the system IP address on the LCD screen.

Now you can login Web GUI to create a RAID Array for your TS2060

Figure 12.

13 Login Web GUI

To access Web GUI utility, launch the web browser on your computer and enter the TS2060's IP address in the address field. Login Name: admin Password: 1234



Figure 13.

NOTE: By default, the Web GUI's network connection type is set to **Automatic configuration - DHCP**, which should be kept only if your network supports DHCP or you are connecting through a dynamic IP address.

The TS2060's IP address should be seen on the screen of the controller. By default the IP address is **192.168.0.200**



If you are required to use a permanent IP address, you need to set a static IP address for the system. (Please refer to User Manual CD for detail information)

TS2060 IP

Quick start guide

14 Create a RAID Array

You will be using the Quick Install function in the Web GUI to create a RAID and User Data Volume for your TS2060.

NOTE: The Quick Install function is designed for set up a single RAID level with a single User Data Volume. If you want to configure your system with multiple RAID levels with multiple User Data Volumes please learn from system User Manual CD for complete instructions.



Step 1: Select Quick Install then choose the RAID Level desired. After choosing the RAID level, click NEXT.



Step 2: In this step, the volume can be customized as needed. Volume size, Bus ID, SCSI ID, and LUN can be assigned specified numbers to be attributed to the volume. The maximum volume size is shown as default. The volume can only be less or equal to the number shown. By default, the Bus ID, SCSI ID, and LUN are set at 0. Click NEXT after desired volume size and IDs are set.



Step 3: Confirm if all the settings are correct then click Confirm to finish the setup.



Done: A summary page with the User data volume will be shown: A RAID 0 user data volume with the UDV name "QUICK86975", named by the system itself, with the total available volume size 222GB.

Figure 14.

NOTE: Depending on the capacity of your system. The RAID array initialization process may take several minutes. Please allow plenty of time for this process. Never turn off your TS2060 while initializing the array.

15 Format Volume for Windows OS

Please refer to your computer's documentation for detailed information on formatting and preparing volumes for use

To format the drive for Windows OS

1. Click on Control Panel, Performance and Maintenance, Administrative Tools.
2. Click on the Computer Management icon.
3. Click on the Disk Management Icon.
4. Right click on the new drive's icon in the right hand window
5. Select the Format option, click yes in warning window.
6. Type a name for the drive under volume label.
7. Select perform quick format option.
8. Click OK in format warning box.
9. The drive will be formatted and available in My Computer and Windows Explorer.

16 Format Volume for Mac OS

Please refer to your computer's documentation for detailed information on formatting and preparing volumes for use

To format the drive for Mac OS

1. Go to the Applications folder on your system hard drive.
2. Open the Utilities folder.
3. Double click on the Disk Utility Program.
4. Find the drive in the left hand window and select the drive.
5. Click on the Partition tab.
6. Under Volume Scheme select 1 Partition
7. Type a name for the drive in the box provided.
8. Select Mac OS extended under the format options.
9. Click on Partition in the Partition dialog box.
10. The drive will be formatted and mounted on the desktop.

17

Troubleshooting

This section covers some common support questions. If you are experiencing an urgent issue, please contact your dealer or call 1-562-777-3488 ex 119.

Connection Problems:

Always double check for loose cable connections or improperly seated disks if you experience problems where a disk or volume does not appear in your computer, or you receive an error message stating a disk missing when you have the drives configured as a RAID set.

1. Disconnect the data cables and reconnect each cable one at a time, ensuring each connector is screwed in securely on your system.
2. Make sure the connector is properly secured on your HBA.
3. Check your TS2060 IP's drive presence LEDs, located on the front panel of the system. If the LEDs are not lit, remove the disk and reinsert the disk module.

If the problem persists, please contact your dealer or contact Enhance's support department at support@enhance-tech.com

Two (2) Year Limited Warranty

WARRANTY COVERAGE

Enhance Technology's warranty obligations are limited to the terms set forth below:

Enhance Technology, as defined below, warrants this Enhance Technology-branded hardware product against defects in materials and workmanship under normal use for a period of TWO (2) YEARS from the date of retail purchase by the original end-user purchaser ("Warranty Period"). If a hardware defect arises and a valid claim is received within the Warranty Period, at its option, Enhance Technology will either (1) repair the hardware defect at no charge, using new or refurbished replacement parts, or (2) exchange the product with a product that is new or which has been manufactured from new or serviceable used parts and is at least functionally equivalent to the original product. Enhance Technology may request that you replace defective parts with new or refurbished user-installable parts that Enhance Technology provides in fulfillment of its warranty obligation. A replacement product or part, including a user-installable part that has been installed in accordance with instructions provided by Enhance Technology, assumes the remaining warranty of the original product or ninety (90) days from the date of replacement or repair, whichever provides longer coverage for you. When a product or part is exchanged, any replacement item becomes your property and the replaced item becomes Enhance Technology's property. Parts provided by Enhance Technology in fulfillment of its warranty obligation must be used in products for which warranty service is claimed. When a refund is given, the product for which the refund is provided must be returned to Enhance Technology and becomes Enhance Technology's property.

EXCLUSIONS AND LIMITATIONS

This Limited Warranty applies only to hardware products manufactured by or for Enhance Technology that can be identified by the "Enhance Technology" trademark, trade name, or logo affixed to them. The Limited Warranty does not apply to any non-Enhance Technology hardware products or any software, even if packaged or sold with Enhance Technology hardware. Manufacturers, suppliers, or publishers, other than Enhance Technology, may provide their own warranties to the end user purchaser, but Enhance Technology, in so far as permitted by law, provides their products "as is". Software distributed by Enhance Technology with or without the Enhance Technology brand name (including, but not limited to system software) is not covered under this Limited Warranty. Refer to the licensing agreement accompanying the software for details of your rights with respect to its use.

Enhance Technology does not warrant that the operation of the product will be uninterrupted or error-free. Enhance Technology is not responsible for damage arising from failure to follow instructions relating to the product's use.

This warranty does not apply: (a) to damage caused by use with non-Enhance Technology products; (b) to damage caused by accident, abuse, misuse, flood, fire, earthquake or other external causes; (c) to damage caused by operating the product outside the permitted or intended uses described by Enhance Technology; (d) to damage caused by service (including upgrades and expansions) performed by anyone who is not a representative of Enhance Technology or an Enhance Technology Authorized Service Provider; (e) to a product or part that has been modified to significantly alter functionality or capability without the written permission of Enhance Technology; (f) to consumable parts, such as batteries, unless damage has occurred due to a defect in materials or workmanship; or (g) if any Enhance Technology serial number has been removed or defaced.

TO THE EXTENT PERMITTED BY LAW, THIS WARRANTY AND REMEDIES SET FORTH ABOVE ARE EXCLUSIVE AND IN LIEU OF ALL OTHER WARRANTIES, REMEDIES AND CONDITIONS, WHETHER ORAL OR WRITTEN, STATUTORY, EXPRESS OR IMPLIED. AS PERMITTED BY APPLICABLE LAW, ENHANCE TECHNOLOGY SPECIFICALLY DISCLAIMS ANY AND ALL STATUTORY OR IMPLIED WARRANTIES, INCLUDING, WITHOUT LIMITATION, WARRANTIES OF MERCHANTABILITY, FITNESS FOR A PARTICULAR PURPOSE AND WARRANTIES AGAINST HIDDEN OR LATENT DEFECTS. IF ENHANCE TECHNOLOGY CANNOT LAWFULLY DISCLAIM STATUTORY OR IMPLIED WARRANTIES THEN TO THE EXTENT PERMITTED BY LAW, ALL SUCH WARRANTIES SHALL BE LIMITED IN DURATION TO THE DURATION OF THIS EXPRESS WARRANTY AND TO REPAIR OR REPLACEMENT SERVICE AS DETERMINED BY ENHANCE TECHNOLOGY IN ITS SOLE DISCRETION. No Enhance Technology reseller, agent, or employee is authorized to make any modification, extension, or addition to this warranty.

EXCEPT AS PROVIDED IN THIS WARRANTY AND TO THE EXTENT PERMITTED BY LAW, ENHANCE TECHNOLOGY IS NOT RESPONSIBLE FOR DIRECT, SPECIAL, INCIDENTAL OR CONSEQUENTIAL DAMAGES RESULTING FROM ANY BREACH OF WARRANTY OR CONDITION, OR UNDER ANY OTHER LEGAL THEORY, INCLUDING BUT NOT LIMITED TO LOSS OF USE; LOSS OF REVENUE; LOSS OF ACTUAL OR ANTICIPATED PROFITS (INCLUDING LOSS OF PROFITS ON CONTRACTS); LOSS OF THE USE OF MONEY; LOSS OF ANTICIPATED SAVINGS; LOSS OF BUSINESS; LOSS OF OPPORTUNITY; LOSS OF GOODWILL; LOSS OF REPUTATION; LOSS OF, DAMAGE TO OR CORRUPTION OF DATA; OR ANY INDIRECT OR CONSEQUENTIAL LOSS OR DAMAGE HOWSOEVER CAUSED INCLUDING THE REPLACEMENT OF EQUIPMENT AND PROPERTY, ANY COSTS OF RECOVERING, PROGRAMMING, OR REPRODUCING ANY PROGRAM OR DATA STORED OR USED WITH ENHANCE TECHNOLOGY PRODUCTS AND ANY FAILURE TO MAINTAIN THE CONFIDENTIALITY OF DATA STORED ON THE PRODUCT. THE FOREGOING LIMITATION SHALL NOT APPLY TO DEATH OR PERSONAL INJURY CLAIMS. ENHANCE TECHNOLOGY DISCLAIMS ANY REPRESENTATION THAT IT WILL BE ABLE TO REPAIR ANY PRODUCT UNDER THIS WARRANTY OR MAKE A PRODUCT EXCHANGE WITHOUT RISK TO OR LOSS OF THE PROGRAMS OR DATA.

CONSUMER PROTECTION LAWS

FOR CONSUMERS WHO ARE COVERED BY CONSUMER PROTECTION LAWS OR REGULATIONS IN THEIR COUNTRY OF PURCHASE OR, IF DIFFERENT, THEIR COUNTRY OF RESIDENCE. THE BENEFITS CONFERRED BY THIS WARRANTY ARE IN ADDITION TO ALL RIGHTS AND REMEDIES CONVEYED BY SUCH CONSUMER PROTECTION LAWS AND REGULATIONS. Some countries, states and provinces do not allow the exclusion or limitation of incidental or consequential damages or exclusions or limitations on the duration of implied warranties or conditions, so the above limitations or exclusions may not apply to you. This warranty gives you specific legal rights, and you may also have other rights that vary by country, state or province.

This Limited Warranty is governed by and construed under the laws of the country in which the product purchase took place. Enhance Technology, the warrantor under this Limited Warranty, is identified at the end of this document according to the country or region in which the product purchase took place.

ENHANCE TECHNOLOGY, INC

© 2009 Enhance Technology, Inc. All rights reserved.

Under the copyright laws, this manual may not be copied, in whole or in part, without the written consent of Enhance Technology, Inc.

Every effort has been made to ensure that the information in this manual is accurate. Enhance Technology is not responsible for printing or clerical errors.

Enhance Technology, Inc.
12221 Florence Ave.
Santa Fe Springs, CA 90670
(562) 777-3488
www.enhance-tech.com