

DC450

"User Manual"

Visualizer
Document
Camera

English

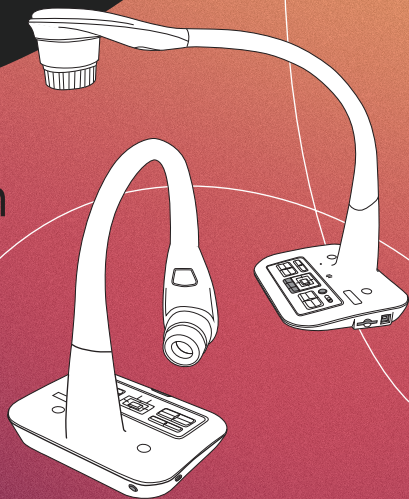

- **Welcome:**

Thanks for purchasing this product. Please read the instructions carefully before using this product.

- **FCC Compliance Statement (Class A):**

This device complies with Part 15 of the FCC Rules. Operation is subject to the following two conditions: (1) this device may not cause harmful interference, and (2) this device must accept any interference received; including interference that may cause undesired operation.

- **Federal Communications Commission (FCC) Statement :**

This Equipment has been tested and found to comply with the limits for a Class A digital device, pursuant to Part 15 of the FCC rules. These limits are designed to provide reasonable protection against harmful interference when the equipment is operated in a commercial environment. This equipment generates, uses and can radiate radio frequency energy and, if not installed and used in accordance with the instructions, may cause harmful interference to radio communications. Operation of this equipment in a residential area is likely to cause harmful interference in which case the user will be required to correct the interference at his own expense.



- **European Community Compliance Statement (Class A):**

This is a class A product. In a domestic environment this product may cause radio interference in which case the user may be required to take adequate measures.



The symbol of the crossed out wheeled bin indicates this product should not be placed in municipal waste. Instead, you need to dispose of the waste equipment by handing it over to a designated collection point for the recycling of waste electrical and electronic equipment.



Warning

1. Do not look directly at the LED light source, which may cause retinal damage.

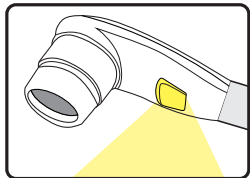

2. Carry the product by holding the base of the main unit in both hands. Never hold the product by the arm or the camera head only.

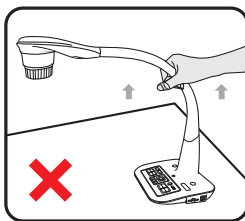
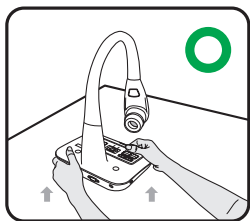

3. The camera can be damaged if it hits a desk surface or any hard object.

4. Never turn the arm in the opposite direction.

5. Be sure to keep one hand on the device base when adjusting the arm and camera head.

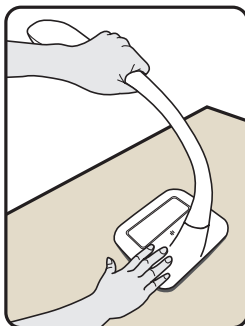

Preparing the Document Camera

● Knowing the Document Camera Parts

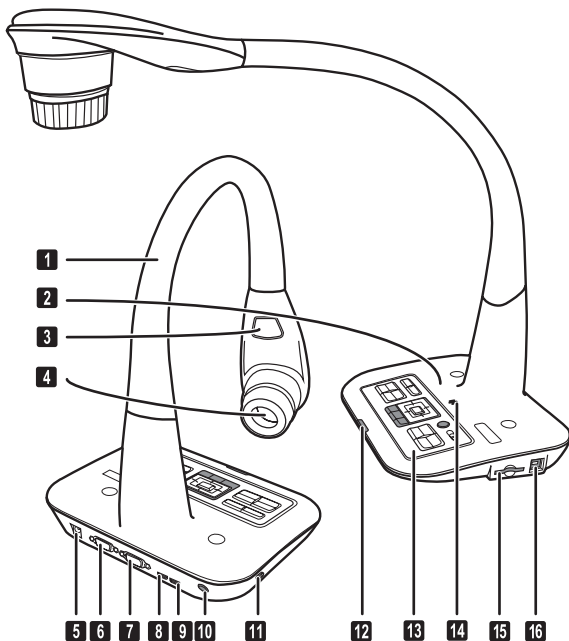





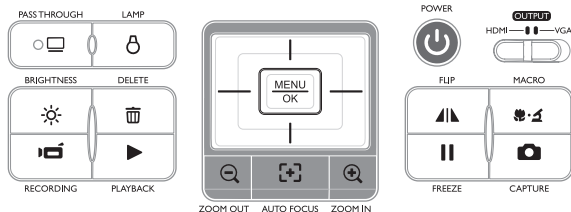













- | | |
|----------------------|-----------------------------------|
| 1 Gooseneck Arm | 9 HDMI Input Port |
| 2 Microphone | 10 Remote Control Signal Receiver |
| 3 LED Lamp | 11 Antitheft Slot |
| 4 Camera Head | 12 Remote Control Signal Receiver |
| 5 DC 5V Power Socket | 13 Control Panel |
| 6 VGA Output Port | 14 Speaker |
| 7 VGA Input Port | 15 SD Card Slot |
| 8 HDMI Output Port | 16 USB Port |



● Control Panel



Button	Function	Button	Function
	Power On/Off.		Zoom out
	Invert image 180°.		Zoom in
	Macro/Normal switch.		One-time auto focus
	Freeze the current image.		Pass the signal from PC via RGB input port to RGB output port.
	Capture a still image.		Turn on/off the LED lamp and adjust the brightness.
	Show menu and select.		Show/hide brightness adjustment bar.
	Direction keys		Delete one file from memory when in playback mode.
	HDMI - VGA Output Switch		Record a video clip.
			Enter playback mode to display recorded pictures and video clips.

● Remote Control

Button	Function
	Brightness hotkey
	Power on / off
	Freeze current image. * Pause the clip while playing videos
ICON	Show or hide on-screen icons
	To show or hide OSD menu
	Playback mode to display recorded pictures and video clips
	Invert image 180°
	Select and adjust
	Record a video clip
	Capture a still image
	Zoom out / Zoom in
	One-shot auto focus
	Use the level bar to adjust the focus manually
	2X or 4X digital zoom
	Highlight function on / off
	Mask function on / off
	Macro / Normal switch
	Adjust highlighted / masked area size
	Set color for highlighted / masked area

Button	Function
	Increase / decrease the sound volume.
	Picture in Picture function on / off *For displaying a still image as an insert while displaying another image.

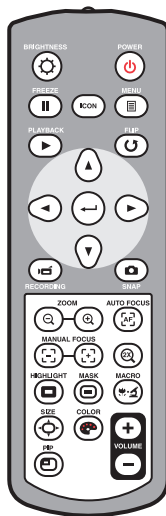

- ❗ Infrared remote control can only be used in proximity to the unit.
- ❗ Remove the battery cover and load the batteries into the battery compartment correctly according to the "+" and "-" symbols.
- ❗ Be sure to use two AAA batteries. Do not use new and old batteries or different battery types together.

Setting Up

This section provides useful tips on how to adjust the document camera smoothly for your needs.

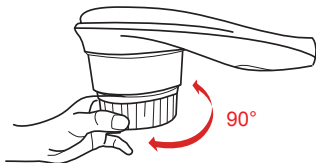

● Rotate Function

Roll the lens rotator to rotate image 90°



● Illumination Lamp

If you are in a dark environment, please turn the LED lamp on to make better exposure.

1. Press the LED lamp button () on the base to turn on/off the LED lamp.
2. Adjusting the brightness by pressing the lamp button ()

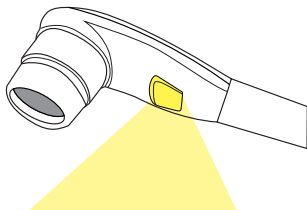

● Output Switch

Adjust the Output Switch on the control panel according to your output port.

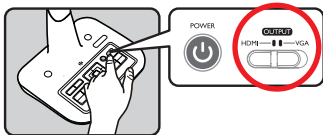

● Gooseneck Arm

The gooseneck arm can be adjusted to support various working areas.

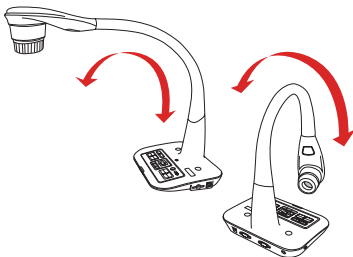

● Working Area

► working area

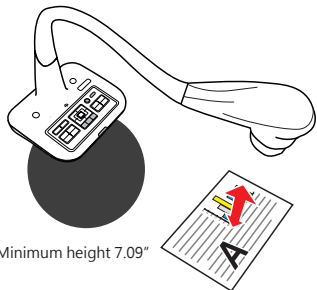
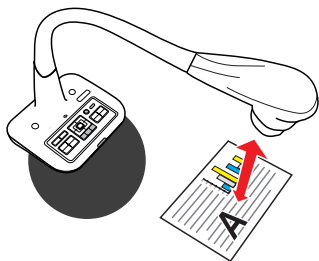
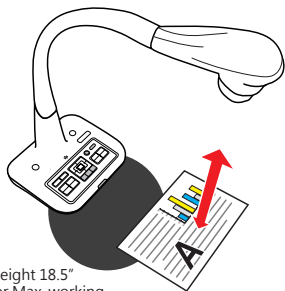
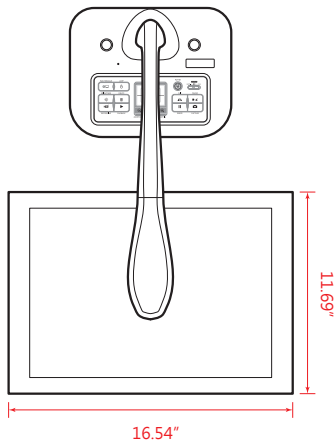

❗ If the document is not put in the recommend working area, the image should be rotated

by FLIP button (🔄) on control panel or remote control.

● Adjusting the brightness

1. Press BRIGHTNESS button on the control panel (-☀-) or remote control (☀).
2. Use (◀ or ▶) buttons to increase or decrease the brightness level.

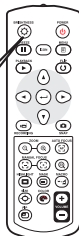
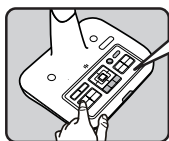

● Zoom Function

Use the Zoom buttons (⊕ / ⊖) to zoom in or zoom out the screen.

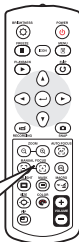
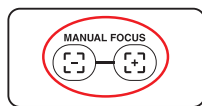
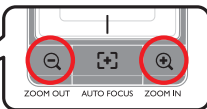
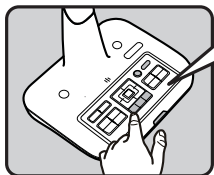

● Flip Function

Press the Flip Button (▲/▼) to flip image

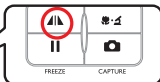
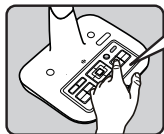

● Adjusting the Focus

▶ Automatic Focus

Press AF button (AF) to do an one-time auto focus. This function provides a one-time auto-focus.

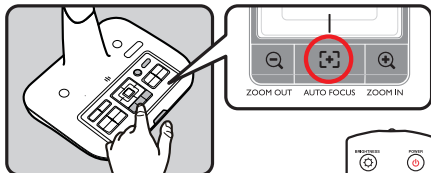

▶ Manual Focus

Use the manual focus buttons ([-]/[+])(★) on remote control to finetune the focus.



● Anti-glare

Anti-glare sheet is a transparent plastic that is overlaid on top of shiny object or glossy surface to reduce the glare.

To use, simply place the anti-glare sheet on top of shiny object to glossy surface such as magazine to reduce light reflection.

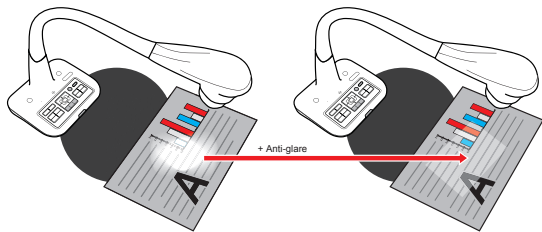

● Adjust the White Balance

1. Default white balance setting of the document camera is "Auto" .
2. There are various modes (Auto, Flurescent, Tungsten and Custom) for user to choose and fit in different surroundings.
3. Custom white balance:

Press "MENU" ($\frac{\text{MENU}}{\text{OK}}$) button → White Balance → enter "Custom" mode.
There will have a pop out window as the picture below:

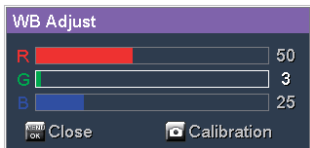

Press CAPTURE () button to get the data of the current image.

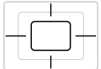
Use the " Direction Key" () to adjust the number of R, G and B parameters.

Press " OK" ($\frac{\text{MENU}}{\text{OK}}$) button to finish setting and close the pop out window.

● Inserting and Ejecting a SD / SDHC card (Not supplied)

1. Insert a memory card (SD/SDHC/MMC/MMC 2.0) with the label facing up until it reaches the end of the slot.
2. When the card is inserted successfully, the icon () will appear on screen and the internal memory will become inaccessible.
3. To remove the card, push the card to release it and then pull it out gently.

- ❗ When using a new memory card, you are recommended to format the card with the device. Do not turn off the device while formatting the SD card.
- ❗ Even if your card has been formatted on other devices, you may have to reformat the card with the device.
- ❗ If no external storage devices are connected, all files will be saved in the built-in memory.

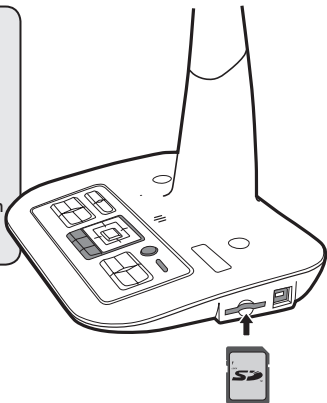

Making the Connections

● System Diagram

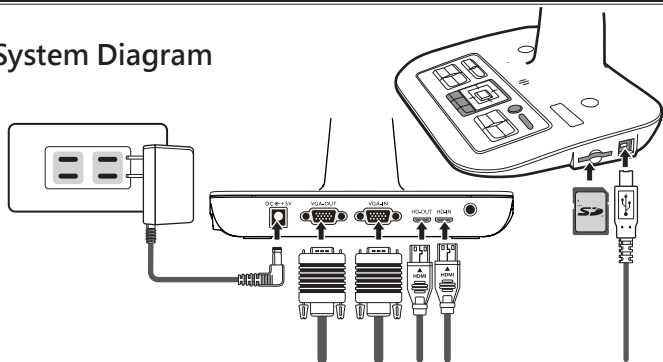

Step 1 / Plugging in the Power Outlet

Use power adapter to connect DC IN connector on the product to a standard 100V~240V AC power outlet.

! The type of power adapter is depending on your countries / regions.

















Step 2 / Output Resolution and Aspect Ratio.

Various output resolutions are available depending on the output and aspect ratio setting. Please refer to the table listed below :

Out put	Aspect-Ratio	Resolution	Vertical Frequency
VGA	4:3	1024 x 768	50 / 60 Hz
		1600 x 1200	
HDMI	16:9	1280 x 720	50 / 60 Hz
		1920 x 1080	

*Document camera will downgrade the output resolution automatically when the connected display device doesn't support highest resolution.

Step 2 / Connecting with Components

	Product Port	Cable	Display Device Port	PC Port
VGA	 RGB OUTPUT		 RGB INPUT	
	 RGB INPUT			 RGB OUTPUT
HDMI	 Mini HD OUT		 HDMI-INPUT	
	 Mini HD IN			 HDMI-OUTPUT
USB	 TYPE B Port		 TYPE A Port	 TYPE A Port

► Standard TV and Projector

• Connect via VGA OUTPUT

To display images, you can use VGA cable to connect to your television's RGB port via the VGA OUT connector.

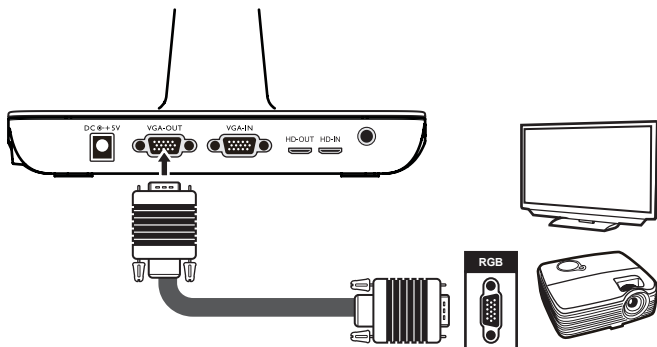

● Connect to a computer

► Passthrough Function

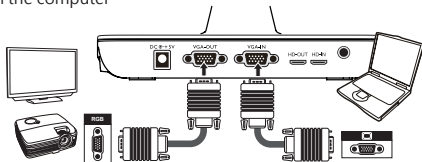

Use VGA Cable to connect VGA IN connector on the document camera to the VGA OUT connector on the computer

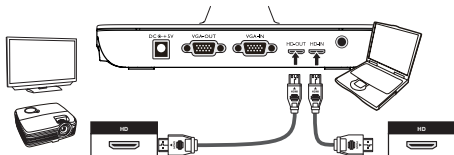

► Use HDMI Cable to connect HDMI IN

Connector on the document camera to the HDMI Out connector on the computer.



- ❶ To display computer image, press PASSTHROUGH button () on the control panel.
- ❷ For laptop to output display mode, use the keyboard command (Fn + ) to switch between the display modes. For different command, please refer to your laptop manual.
- ❸ The signal is only pass through from VGA IN port to VGA OUT port or HDMI In port to HDMI Out port on document camera.
Please connect an output device to display the image on computer.

► Connect via USB



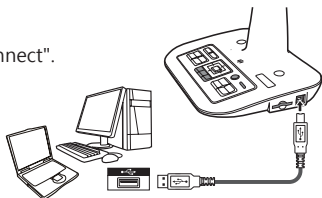









Press MENU () button → select "USB Connect".
Choose "Disk" to connect mass storage.
Choose "PC Cam" to use as a PC-Cam.

















Basic Operation





1. Press MENU button on the remote control () or control panel ($\frac{\text{MENU}}{\text{OK}}$).
2. Press (\blacktriangleleft or \blacktriangleright) button to toggle between tabs.
3. Press OK button on the remote control (\blackleftarrow) or control panel ($\frac{\text{MENU}}{\text{OK}}$) to make a selection and display the setting selections.
4. Use (\blacktriangleleft or \blacktriangleright) to adjust the setting.
5. Press OK button on the remote control (\blackleftarrow) or control panel ($\frac{\text{MENU}}{\text{OK}}$) to make the new setting activate.
6. Press MENU button on the remote control or EXIT on the OSD menu to hide the OSD menu.

● Menu options in Preview Mode

Name	icon	Option	Description
Brightness		-	Use the Right / Left buttons to make the image brighter / darker
Effect		Graphic	To improve the tint of color-based subjects such as pictures or figures.
		Text	The function is designed especially for text-based documents to which can be enhanced white and black subjects such as characters and lines.
		B&W	To output a black & white camera image. To make the image easier to view, select this when shooting black & white documents etc.
		Negative	To output a negative camera image.
		Sketch	To output a sketch camera image.
White Balance		Auto	There are various modes (Auto, Fluorescent, Tungsten and Custom) for user to choose and fit in different surroundings.
		Fluorescent	
		Tungsten	
		Custom	
Quick Zoom		2X / 4X	Set the quick zoom to 2X or 4X.
Focus		Normal	Select standard mode for 25cm ~ ∞.
		Macro / Microscope	Select Macro/Microscope mode to take close-ups or while connecting to a microscope.

Name	icon	Option	Description	
Still Resolution		0.8M / 2M 5M / 8M	Select the desired still image resolution.	
SETTING	Beep		On / Off	Enable beep sound on / off
	Flicker		50Hz / 60Hz	Set flicker frequency to 50Hz or 60Hz The flicker setting is based on the frequency standard of your local power supply.
	USB Connect		Off	Disable USB function
			Disk	Select "Disk" to enter Mass storage Mode
			PC cam	Select "PC Cam " to enter PC Cam Mode
	HDMI Out		720p	Adjust HD-OUTPUT resolution
			1080i	
	VGA Out		XGA	Adjust VGA-OUTPUT resolution
			UXGA	
	Clock		-	Set date and time
	Language		-	Allows you select the language used for OSD
	Format		No / Yes	Format the storage medium. Note that all files stored in the medium will be gone.
Reset default		No / Yes	Restore factory defaults. Note that your current settings will be overwritten.	
Exit		-	Exit Menu.	

● Menu options in Playback Mode

Name	icon	Option	Description
File Info		-	View the file' s title , saved date and time , size and the length of recording.
Slide show		On / off	Start / Stop Slide Show
Delete one		Yes / No	Delete current file.
Delete all		Yes / No	Delete all images of the same type stored in the memory.
Exit		-	Exit menu.

● Recording a video clip / Taking a still picture

1. Set the capture or record resolution.

according to the setting, please refer to the table below:

Output Switch	Resolution Setting	Capture resolution	Recording resolution
VGA	XGA	1024 x 768	1024 x 768
	UXGA	1600 x 1200	
HDMI	720P	1280 x 720	1280 x 720
	1080i	1920 x 1080	1920 x 1080

2. Choose the focus mode according to distance to object:

Normal mode for 25cm to ∞.

Macro mode (🌸) or (🔍)(★) to take close - ups.



3. Use the Zoom button (🔍/🔍) to zoom in or zoom out from the screen.

4. Automatic focus/Manual focus

Press AF button (📷) to do one-time auto-focus.

Use manual focus button (📷/📷)(★) on the remote control to fine-tune focus.

5. Press the Recording button (📹) to start recording and press it again to stop recording.

Press the Capture button (📷) to take a still picture.

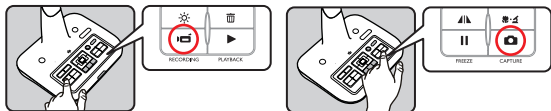

● Playback

1. Press PLAYBACK button (▶).



2. The last recorded picture or video clip will show on the screen.

3. Use Up / Down button to choose files.

● Copying Files to Computer

Please notice that the video clips are recorded in AVI format and are compiled as CLIPxxxx.avi (xxxx are four serial numbers).

Before viewing these videos on your PC, you may need to install some media programs.

1. Turn on the document camera.
2. Connect the product to your computer with USB cable.
3. Press MENU ($\frac{\text{MENU}}{\text{OK}}$) → select "USB Connect " → choose "Disk ". The built-in memory or external memory will be detected.

Then, You can view the image data on a SD card on the PC' s viewer software or simply cut/ copy and paste the file to your PC.

⚠ When the operating panel or the remote control is in operation, do not connect or disconnect the USB cable, as this may cause malfunctions of the device to occur.

● Using document camera as a PC cam

Starting the application

1. Connect the product to your computer.
Turn on your computer, then connect the accessory USB cable to the USB port of your computer.
Make sure the connector and the port are aligned correctly.

Switch to PC Cam mode.

Connect the other end of the USB cable to the main unit.

Power on press MENU ($\frac{\text{MENU}}{\text{OK}}$) → Setting → select USB Connect → select PC Cam () and press OK button to confirm.

2. Launch PC Camera
After the product is correctly connected to and detected by your PC, you are ready to use PC Camera function.

Working with Smart DC

1. Make sure the USB connection setting is at "PC-Cam" .
2. Connect device and PC with accessory USB cable.
3. Start Smart DC on your PC.

Advance Operation

● Highlight function / Mask function(★)

Highlight function



1. Use the Highlight function to draw attention to a particular section of the output image.
2. Press the Highlight button () on the remote control, and use the direction buttons to move the highlighted area.

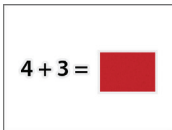

Mask function

1. You can mask a section of the output image.
2. Press the Mask button () on the remote control, and use the direction buttons to move the masked area.



- ❗ Press the Size button () on the remote control, and use the direction buttons to adjust the highlighted / masked size.
- ❗ Press the Color button () on the remote control, and use the direction buttons to adjust the color of highlighted / masked area.

● PIP (Picture in Picture) function(★)

1. Press the PIP button () to display an around quarter-size still image on a live camera display.
2. Use the up or down button to change the shift between still images.

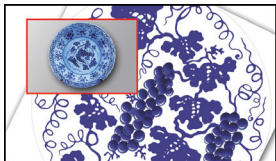

● Connect to a microscope

Connect to a microscope enables you to examine microscopic objects on a big screen.

1. Adjust the microscope and focus objects.
2. Choose an appropriate microscope adapter.
3. Microscope adapter accessories are applicable to $\varnothing 28\text{mm}$, $\varnothing 31\text{mm}$, $\varnothing 33\text{mm}$, and $\varnothing 34\text{mm}$ eyepieces.

- ❗ For eyepieces of about $\varnothing 33\text{mm}$, $\varnothing 34\text{mm}$, only a microscope adaptor should be installed.
- ❗ For a $\varnothing 28\text{mm}$ eyepiece, insert the $\varnothing 28\text{mm}$ adapter into the microscope adapter.
- ❗ For a $\varnothing 31\text{mm}$ eyepiece, insert the $\varnothing 31\text{mm}$ adapter into the microscope adapter.

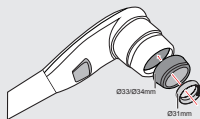
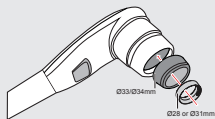
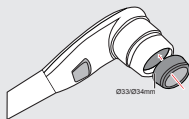

4. Mount / take off the microscope adapter onto / off the lens by doing the action shown in the picture.

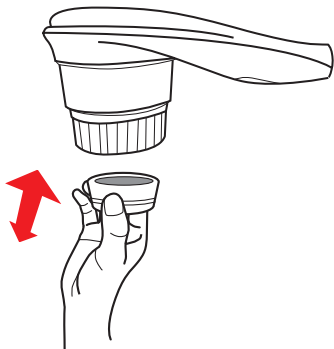

5. Switch the focus mode to Macro.

Press MENU ($\frac{\text{MENU}}{\text{OK}}$) --> select Focus ($\left[\begin{smallmatrix} \oplus \\ \ominus \end{smallmatrix} \right]$) -->

select Macro



or press Macro button ($\left[\begin{smallmatrix} \text{M} \\ \text{M} \end{smallmatrix} \right]$) (★) on remote controller.

6. Connect the lens with microscope adapter to the microscope.

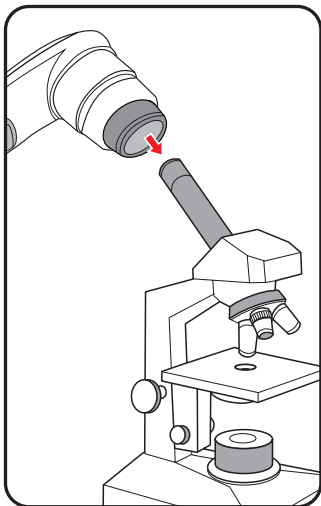

❗ If the image is not clear. Please adjust the focus of microscope.

❗ Press the AF button ($\left[\begin{smallmatrix} + \\ + \end{smallmatrix} \right]$) or use the manual focus button on remote control to fine-tune the focus.

Storing

1. Power off the product.

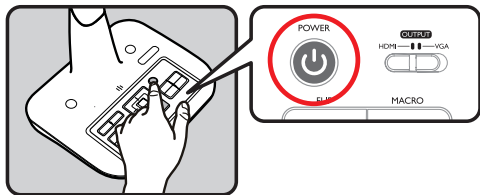

2. Unplug the AC adapter from the wall outlet. Then, disconnected the AC Adapter and all cables.

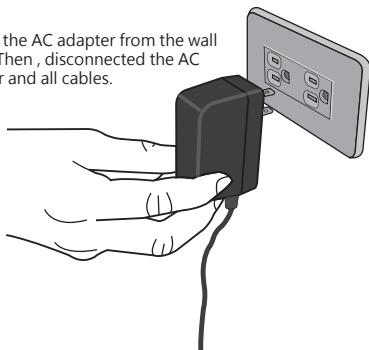

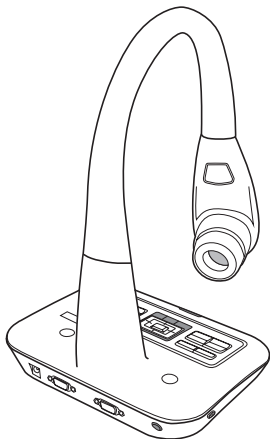

3. Fold the camera head and arms in the direction shown in the figure.



Troubleshooting

When using the document camera :		
Problem	Cause	Solution
Cannot be powered on normally.	The AC adapter is not correctly connected to the wall outlet or the document camera.	Re-connect one end of the AC adapter to the document camera and the other end to a wall outlet.
Cannot take pictures and video clips.	Out of memory.	Free some space from the SD / MMC card or the internal memory.
	Using a "protected" SD card.	Set the SD card to be written in.
No image output after connecting.	The document camera is not correctly connected to the external device.	Re-connect all related cables with the external device correctly.
	Incorrect input type of display output device.	Set up correct input type of display output device.
	Incorrect supported resolution of display output device.	Set up correct supported resolution of display output device.
	Incorrect output port selected by output switch on document camera.	Set up correct output port by output switch.
	PC pass through button indicator is on.	Press [] PASSTHROUGH button to turn off the function.

When using the document camera :		
Problem	Cause	Solution
The image is fuzzy.	Probably the distance of object is too close to the lens.	Press AF button to auto focus or adjust by pressing Manual Focus.
		Select Macro mode if the distance is less 25cm.
The image is reverse.	The document is not put in the recommend working area.	Press [] button to adjust the direction.
The image dose not move.	Camera image is set to Freeze [].	Press the [] button on the control panel again to unpaue.
Remote control can not work.	No power.	Replace the AAA batteries in the remote control.
	Object is blocking the remote control signal receiver of the document camera.	Remove obstruction in front of the product.
	The distance of usage is too far.	Stand closer to the product to use the remote control.
The display device displays "MEMORY ERROR" or "CARD ERROR" message. Or memory card cannot be read.	The format of the memory card is not compatible with the product.	Use the "Format" function of the document camera to format the card.
	The memory card is corrupted.	Replace the memory card with a new one.

When using the document camera :		
Problem	Cause	Solution
Cannot delete the pictures and video clips, and also cannot find them in the memory card.	The lost recordings are saved in the internal memory.	It happens when you insert a memory card after taking a few pictures or video clips. You can access those files after removing the memory card.
Cannot view the video clips on my computer.	Software is not installed on the computer.	Install Direct X 9.0c or above and Windows Media 9.0 Co-decs to solve this problem. Go to the website " http://www.microsoft.com " to download the required files. Please refer to "Copying files to your computer" .
TV screen does not display after connecting the product to TV.	The product is not correctly connected to the TV.	Reconnect the product to TV correctly.
Noises occur when viewing images on the computer.	The flicker setting does not match the standard of the country you are staying.	Adjust the flicker setting .

! The contents in this manual are subject to change without prior notification.