

# VETEK

*Scandinavia's biggest webshop for scales*



## User Manual weighing scale JWL.

# CONTENTS

<b>1. Introduction</b> .....	1
<b>2. Precautions</b> .....	1
<b>3. Before Using the Product</b>	
3-1 Unpacking and Checking.....	1
3-2 Installing Components .....	1
3-3 Leveling the Scale.....	1
<b>4. Product Introduction</b>	
4-1 Specifications & General Features .....	2
4-2 Display .....	3
4-3 Keyboard.....	4
4-4 Power Supply.....	4
<b>5. Operation</b>	
5-1 Weighing.....	4
5-2 Manual Tare & Preset Tare .....	5
5-3 Checkweighing .....	5
5-4 Simple Counting.....	6
5-5 Accumulation, Accumulation Display and Accumulation Clearing.....	6
5-6 Unit setting menu.....	6
<b>6. Calibration</b>	
6-1 Single Point Calibration .....	7
6-2 Linear Calibration.....	7
<b>7. Setting Mode &amp; Description of Parameter Values</b> .....	8
<b>Serial Interface</b>	
8-1 RS-232 Connector.....	10
8-2 Single Option.....	10
<b>Troubleshooting and Error Message</b> .....	13

## 1. Introduction

This manual contains installation and operation instructions for the JWL Series weighing scale. Please read the manual completely before installation and operation.

## 2. Precautions

- ⊙ Place the scale on a flat and stable surface( Refer to Section 3-3).
- ⊙ Verify that the input voltage and the plug type matches the local AC power supply( Refer to Section 4-4).
- ⊙ Make sure power cord does not pose a potential obstacle or tripping hazard.
- ⊙ Keep the scale away from EMI noise, strong wind and vibration, which might cause incorrect reading.
- ⊙ Avoid sudden temperature changes (suitable operating temperature is between -5°C~ 40°C.)
- ⊙ do not drop loads on the platform.
- ⊙ Disconnect the power supply while cleaning the scale.
- ⊙ Do not immerse the scale in water or other liquids.
- ⊙ Service should be performed by authorized personnel only.

## 3. Before Using the Product

### 3-1 Unpacking and Checking

Open the package and check the instrument for transport damage. Immediately inform your dealer if you have complaints or if parts are missing. The package should contain:

- Scale body
- Weighing platform (plastic base with stainless steel pan)
- Power cord
- User manual

### 3-2 Installing Components

1) Before using the scale, remove the delivery protection screw (rotate counterclockwise), which located underneath the scale, and cork the plug buckle.

Note: the JWL-30K model is shipped without the shipping protection screw.

2) Cover the weighing pans on the scale body properly.

### 3-3 Leveling the Scale

To compensate for small irregularities or inclinations at the location, the scale can be leveled. The scale is equipped with a level indicator at the front panel .Adjust the leveling feet until the air bubble in the indicator is centered as shown.



Note: The scale should be leveled each time its location is changed.

## 4-1 Specifications & General Features

### Specifications

Model	1.5K	3K	6K	7.5K	15K	30K
Capacity (Kg)	1.5	3	6	7.5	15	30
Division-1 (g)	0.5	1	2	2	5	10
Division-2 (g)	0.2	0.5	1	1	2	5
Division-3 (g)	0.1	0.2	0.5	0.5	1	2
Division-4 (g)	0.05	0.1	0.2	0.2	0.5	1
Display	LCD(liquid crystal display), digits 31mm high, with back lighting					
Pan size	294X228X13.5mm					
Scale Dimensions	341X294X104mm					
Power Supply	AC 110V/220V (AC±10%) or built-in rechargeable battery (6V/4A)					

### General Features

- Easy to clean smooth ABS plastic housing with included in-use cover and stainless steel weighing pan
- Large bright backlit 6 digit LCD with prominent 31mm high digits
- RS-232 serial communication interface
- Overload and delivery protection device
- Multiple weighing units including: kg,g,lb,斤两 and pcs
- Auto shut off, low battery and charging status indication
- Multiple functions : tare, preset tare, simple counting, checkweighing and Accumulation.
- Single point calibration and linear calibration available
- CE type approved

### 4-2 Display





Low battery indication



Tare or Preset Tare Indication



Center of Zero Indication, The zeroing range is  $\pm 2\%$  of weighing capacity.



Auxiliary display (parameter, accumulated number of weighments)

**TARE** Symbol “▼” points at “**TARE**” when manual Tare action is done.

**Preset Tare.** Symbol “▼” points at “**Preset Tare**” when preset tare value is set.

**NET** Net weight--Gross weight minus Tare. Symbol “▼” points at “**NET**” when manual Tare or preset are actions are done.

**UW** Under simple counting mode, Symbol “▼” points at “**UW**” when calculated unit weight is lower than 4/5 of scale division. Unit weight is too small for ensuring accurate quantity calculations.

*pcs %*

*斤兩*

*lb oz*

*kg* Units of measure

**HI** The weight on the weighing pan is greater than the upper limit.

**OK** The weight on the weighing pan is between upper and lower limits.

**LO** The weight on the weighing pan is smaller than lower limit.



Stable indication



CHARGE Charge Lamp

Red--- battery is charging

Green---battery is fully charged

## 4-3 Keyboard

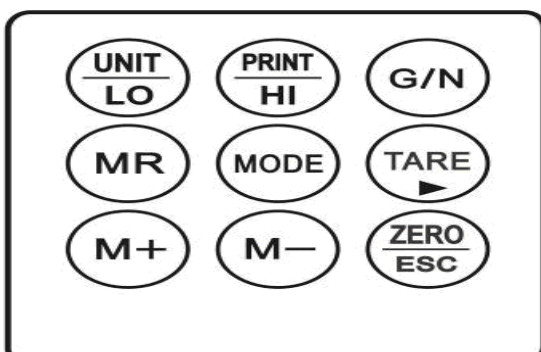

### **UNIT/LO** key

- \* Short press steps through activated weigh units and release on desired unit
- \* Long press lower limit initials lower limit setting
- \* Shift key( shift leftwards)

### **PRINT/HI** key

- \* Short press sends data a RS232 port; long press lower limit initials lower limit setting
- \* Shift key (shift rightwards)

### **G/N** key

- \* Displays gross and net weight by turns
- \* Stores current condition

### **MR** key

- \* Memory recall
- \* Switches on /off check weighing function
- \* Long press enters max. Capacity setting mode

### **MODE** key Long press to initials function setting

### **TARE** key

- \* Tares the weight of the container
- \* Accepts the keypad tare entrie

### **M+** key

- \* Adds the indicated weight into Accumulation memory
- \* During editing selects the next higher option or increases setting values.

### **M-** key

- \* Deletes accumulation records
- \* During editing, selects the next lower option or decreases setting values.

### **ZERO/ESC** key

- \* Zeros the display (within 2% of max.capacity)
- \* Exits from setting mode.

## **4-4 Power Supply**

Please verify the local AC power source and switch the two-stage switch (110V/220V) to the proper place before plugging into the power outlet.

### **Alternative Power Supply**

- 1) AC 110V/220V (AC±10%)
- 2) (6V/4A) Internal Rechargeable Battery

### **Power Consumption**

About 300mW, 80hrs (without backlight)

About 380 mW, 65hrs (with backlight)

## Low Battery Warning

When  appears in the upper left corner of the weight window, the battery requires recharging. The charge lamp turns green from red when the recharging is completed (which takes about 8 hours). Disconnect the scale from power supply when it is fully charged.

## 5-1 Weighing

Begin with no load on the scale, the display reading zero. Place item(s) to be weighed on the scale. The display shown is 1000.0g, gross weight. (The desired weighing unit should be selected before weighing, refer to section 5-5.)



## 5-2 Manual Tare & Preset Tare

When weighing a sample that must be held in a container, tare stores the container weight into memory.

### Manual Tare

- 1) Under the weighing mode, place the container on the weighing pan, wait till stable symbol appears, and press the key **TARE**. The container is tared.



- 2) Place the item(s) to be weighed into the container. The weight displayed is the net weight.



- 3) Remove all items from the weighing pan; the screen displays the tare value.



- 4) To clear tare with an empty pan, Press down key **TARE** or key **ZERO/ESC**.

### Preset Tare

- 1) Long press key **TARE** for 3 seconds. The scale is now in Digital inputting mode with the

left-most digit blinking. 

- 2) Press key **UNIT/LO** to shift leftwards, key **PRINT/HI** to shift rightwards, key **M+** to increase setting values and key **M-** to decrease setting value. E.g. here we set the Preset

Tare value as 1000.0g. 

3) Press key **G/N** to save and return to weighing mode, the screen display “” before

reverting to preset tare value.  → 

2) Put the load on the container, the scale will automatically deduct the value of the container from the total value.

**NOTE:** Press Key **G/N** to display gross and net weight by turns.

### 5-3 Checkweighing

Use this mode to compare the weight of an item to Lower, and Upper limits. When the checkweigh mode is enabled, the “▼” indicator will turn on.

#### Lower limit setting

1) Began by pressing down key **UNIT/LO** for 3 seconds. The scale is now in Digital

inputting mode with the left-most digit blinking. 

2) Press key **M+** to increase setting values, key **M-** to decrease setting value, key

**UNIT/LO** to shift leftwards and key **PRINT/HI** to shift rightwards. 

3) To save the Lower limit and return to weighing mode, Press key **G/N**.

#### Upper limit setting

1) Began by Pressing down key **PRINT/HI** for 3 seconds. The scale is now in Digital inputting mode with the left-most digit blinking.

2) Press key **M+** to increase setting values, key **M-** to decrease setting value, key

**UNIT/LO** to shift leftwards and key **PRINT/HI** to shift rightwards. 

3) To save the upper limit and return to weighing mode, Press key **G/N**.

**Place the sample on the weighing pan, if the sample weight is under the lower weight range, the LOW lamp will light up. If the sample is within the lower and upper weight range the OK lamp will light up. If the sample is over the upper weight range, the HI lamp will light up.**

### 5-4 Simple Counting

1) Press key **UNIT/LO** to select the unit “PCS”. 

2) Press key **G/N** , the ex-factory default sample size (10 pcs) is displayed. 

3) Press key **M+** to choose the sampling amount .Available options are 10, 20, 50, 100, 200,



500、1000( pieces) . 

4) Put the corresponding samples on the weighing pan, and then press key **G/N**. "507.06" is displayed momentarily before the display reverts to the sample size.

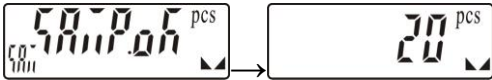

5) Remove the samples and put the load on, the scale begins to count.

**Note:**

1. The larger the sample size, the more accurate unit weight.
2. Symbol "▼" points at "UW" when calculated unit weight is lower than 4/5 of scale division.

### 5-5 Accumulation, Accumulation Display and Accumulation Clearing

1) Under the weighing mode, put the item on the weighing pan. Press key **M+** at the

appearance of "▲▲". "Addone" is displayed momentarily before the display reverts to the



2) Remove the item and the display goes back to zero before the next accumulation can

register.  (The maximum is 20 pieces.)

### Accumulation Display

Press key **MR** to display total accumulation data and each accumulation event in detail.

The number of weighments is indicated by Auxiliary display at the Lower Left corner.

### Accumulation Clearing

To clear accumulation data, press key **M-** while the total weight is displayed. To exit and return to normal weighing mode press key **ZERO/ESC**.

### 5-6 Unit setting menu

1) How to enter Unit setting menu?

Method 1: Press and hold key **UNIT/LO** while powering on the scale. 

Method 2: Long press key **MODE** for 3 seconds under normal weighing mode.

"SEL.P" is displayed momentarily before the display reverts to setting item p00.

Press key **M+** or key **M-** to choose setting item p11,(There are 12 available setting items ---p00-p11, indicated by Auxiliary display at the Lower Left corner.) then press key **UNIT/LO**

to start the unit setting menu. 

**2) How to set the init weight unit?**

Press key **UNIT/LO** to set init weight unit and press key **G/N** to save and move to the next setting menu---set the active weight unit.

**4) How to set the active weight units?**

Press key **UNIT/LO** to step through all the available weight units, press key **M+** switch ON/OFF the displayed weight unit, and press key **G/N** to save and move to the next setting menu--- whether to retain the last used weight unit when the unit is turned on.

 -- enable

 -- disable

**5) Whether to retain the last used weight unit when the unit is turned on?**

Press key **M+** to set whether to retain the last set weight unit when the unit is turned on, then press key **G/N** to save and return to normal weighing mode.

 -- Last used weight unit is retained when the unit is turned on.

 -- Last used weight unit is not retained when the unit is turned on.

Note: if enter the Unit setting menu by method 2, press key **G/N** to save and then press key **ZERO/ESC** to return to normal weighing mode.

**6. Calibration**

1. For best results calibrate the scale at regular intervals. This is especially important if the scale is in use for prolonged periods.
2. Calibration weights are not provided with the scale.
3. Here we take JWL-15K as an example.

**6-1 Linear Calibration**

1) Press and hold key **TARE** while powering on the scale. The screen displays “”, then

release the keys. 

2) Again press key **TARE** to enter the zero point calibration modes, with no load on the

scale. 

3) Wait till  appears, put weights of 1/3 of full load on the weighing pan (E.g. for

JWL-6K, 1/3 of full load is 2 kg)



4) Wait till **0.02** appears, put weights of 2/3 of full load on the weighing pan (E.g. for

JWL-6K, 2/3 of full load is 4 kg)



5) Wait till **0.03** appears, put weights of full load on the weighing pan (E.g. for JWL-6K, full

load is 6kg)



6) The calibration procedure ends up with a symbol of “ **PASS** ”.



7) Remove all the weights, and then press key **TARE** to return to weighing mode.

### 6-2 Single Point Calibration

1) Press and hold key **M-** while powering on the scale. The screen displays “ **5.0000** ”, then

release the keys.



2) Press key **TARE** to enter the zero point calibration mode.



3) Wait till the “ **0.0000** ” appears (with the right-most digit blinking), press key **UNIT/LO** to shift leftwards, key **PRINT/HI** to shift rightwards, key **M+** to increase setting values and key **M-**

to decrease setting value.



4) Put the corresponding weights on the weighing pan and press key **N/G**, the calibration procedure starts.

5) A few seconds later, the calibration procedure is completed with a “ **PASS** ” displayed on the screen. Remove all the weights and press key **TARE** to return to normal weighing mode.

### 7. Setting Mode & Description of Parameter Values

1) Long press key **MODE** for 3 seconds, **SEL.P** display momentarily before the display reverts to available setting items. There are 12 available setting items (p00-p11), indicated by

Auxiliary display in the Lower Left corner.



2) Press key **M+** or key **M-** to step through all the available setting items, and release on the

desired one . 

3) Press key **UNIT/LO** or key **PRINT/HI** to set the content values of setting items.





4) Press key **MODE** to save the settings and go back to the weighing mode.

### Description of Parameter Values

1) P00 Set the period of inactivity before the scale automatically turns off. Options are Aut.NO=non power-off, Aut.5, Aut.10, Aut.30 , Aut.60 and Aut.90 (minutes).

2) P01 Set Check Weighing buzzer beep. Options are B-UP,B-in ,B-out and b-low

 There will be a warning sound when the material's weight exceeds the preset upper limit .

 There will be a warning sound when the material's weight is between the upper and lower limits.

 There will be a warning sound when the material's weight exceeds the preset upper and lower limits and the exceeding weight is more than 20 scale divisions.

 There will be a warning sound when the material's weight is under the preset lower limit and the weight is less than 20 scale divisions.

3) P02 Set the desired external devices .Options are PC,SH-24 , BP545D , Godex and ZEBRA.

 = Computer output;

 = SH-24 printer output (dot-matrix)

 =BP545D printer output (Automatic-sticking), paper size: 5cm\*3cm.

 =Godex printer output (Automatic-sticking), paper size: 5cm\*3cm.

 =ZEBRA printer output (Automatic-sticking), paper size: 5cm\*3cm.

4) P03 Set RS-232 Serial Transmission Rate. Options are bA-96(9600),BA48(4800) and BA24(2400).

5) P04 Set Checkweighing value in memory or not.

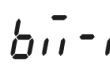
 = Previously set checkweighing values are not retained when the unit is turned on.

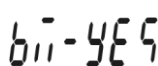
 = Previously set checkweighing values are retained when the unit is turned on.

6) P05 Set Parity check.

*PRr ity* = Enable      *nonE* = Disable

7) P06 Set the activation mode of backlight. Options are ONOFF (Auto on with items greater than 9d placed on the weighing pan or any key is pressed), ON (Backlight on) and OFF (No backlight)

8) P07 Set Print mode.

*PrE-PrE* = manual print      *PrE-SE* = Stable print      *PrE-EO* = Continuous print

9) P08 Set the filtering level in which the stable indication turns on .The higher the setting, the slower stabilization time. Options are Fil 1, Fil 2, Fil 3 and Fil 4.

10) P09 Set the range in which the Zero indication turns on . Options are Zero.0(1 division) , Zero.1(2divisions), Zero.2(3divisions), Zero.3(4 divisons ), Zero.4(5divisions) and Zero.5(6divisions) .

11)P10 Initial Setup (not available )

12) P11 Unit setting( refer to section 5-6).

## 8. Serial Interface

If external interface is needed, please select the proper three-in-one board first, which integrates RTC (time display), RS-232 and relay (weight checking) functional module onto one circuit board. Only after this board is adopted, the three functions can be realized.

### 8-1 RS-232 Connector

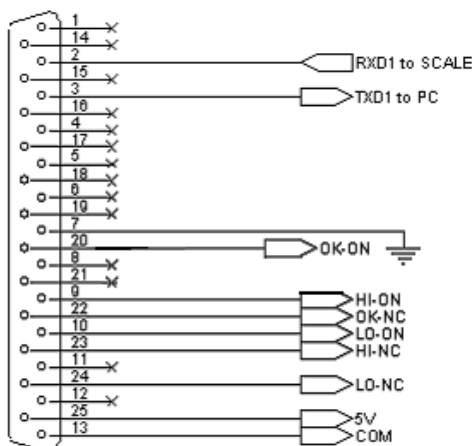

RS232/RELAY

### 8-2 Single Option

- 1) RS232+RTC+Relay+ (SH-24 , BP545D , Godex and ZEBRA) printer
- 2) RS232+RTC+Relay+ LED Light Tower (Applicable to the quality control of the factory product quantity or weight and that of the total production line.)
- 3) RS232+RTC+Relay+Computer

## 9. Troubleshooting and Error Message

Error Status	Possible Causes	Basic Inspection & Treatment
<b>E02</b> no.samp	PCS no sampling	Press down the key <b>N/G</b> to begin sampling.
<b>E04</b> EE.ERR	EEPROM access error	Re-solder EEPROM or contact Service .
<b>E05</b> out.ran	Overload condition	Remove weight that is greater than the scale capacity from the pan.
<b>E07</b> E.Lo>Hi	The weight-checking upper limit value is less than the lower limit value.	Reset the upper limit value
<b>E08</b> CK.UNIT	The unit set for weight-checking is different from the current unit.	Disable weight-checking function or reset HI/LO value.
EU.nit	improper accumulation unit	Return to the previous accumulation unit or accumulate again.