

# Mini User Guide

© Copyright 2009 Hewlett-Packard  
Development Company, L.P.

Microsoft and Windows are U.S. registered  
trademarks of Microsoft Corporation.

The information contained herein is subject  
to change without notice. The only  
warranties for HP products and services are  
set forth in the express warranty statements  
accompanying such products and services.  
Nothing herein should be construed as  
constituting an additional warranty. HP shall  
not be liable for technical or editorial errors  
or omissions contained herein.

First Edition: May 2009

Document Part Number: 530935-001

#### **Product notice**

This user guide describes features that are  
common to most models. Some features  
may not be available on your device.

To obtain the latest information in the *Mini  
User Guide*, go to the HP Web site at  
<http://www.hp.com/support>.

## Safety warning notice

- 
- ⚠ **WARNING!** To reduce the possibility of heat-related injuries or of overheating the device, do not place the device directly on your lap or obstruct the device air vents. Use the device only on a hard, flat surface. Do not allow another hard surface, such as an adjoining optional printer, or a soft surface, such as pillows or rugs or clothing, to block airflow. Also, do not allow the AC adapter to contact the skin or a soft surface, such as pillows or rugs or clothing, during operation. The device and the AC adapter comply with the user-accessible surface temperature limits defined by the International Standard for Safety of Information Technology Equipment (IEC 60950).
-



---

# Table of contents

## 1 Knowing the parts

Identifying the hardware .....	1
Top components .....	1
TouchPad .....	1
Light .....	2
Keys .....	3
Front components .....	3
Right-side components .....	5
Left-side components .....	5
Display components .....	6
Bottom components .....	7
Wireless antennas .....	8
Additional hardware components .....	9
Identifying the labels .....	9

## 2 Power management

Setting power options .....	11
Using power-saving states .....	11
Initiating and exiting Standby .....	11
Initiating and exiting Hibernation .....	12
Using power schemes .....	12
Viewing the current scheme .....	12
Selecting a different power scheme .....	13
Customizing power schemes .....	13
Setting password protection upon exiting Standby .....	13
Using external AC power .....	13
Connecting the AC adapter .....	14
Using battery power .....	14
Displaying the remaining battery charge .....	15
Inserting or removing the battery .....	15
Charging a battery .....	16
Maximizing battery discharge time .....	17
Managing low battery levels .....	17
Identifying low battery levels .....	17

Resolving a low battery level .....	19
Resolving a low battery level when external power is available .....	19
Resolving a low battery level when a charged battery is available .....	19
Resolving a low battery level when no power source is available .....	19
Resolving a low battery level when the device cannot exit Hibernation .....	19
Calibrating a battery .....	19
Step 1: Fully charge the battery .....	19
Step 2: Disable Hibernation and Standby .....	20
Step 3: Discharge the battery .....	20
Step 4: Fully recharge the battery .....	21
Step 5: Reenable Hibernation and Standby .....	21
Conserving battery power .....	21
Storing a battery .....	21
Disposing of a used battery .....	22
Shutting down the device .....	22

### 3 Internet

Connecting to a wired network .....	24
Connecting to a wireless network .....	25
Using wireless devices .....	25
Identifying wireless and network status icons .....	25
Using the wireless controls .....	26
Using the wireless switch .....	26
Using HP Connection Manager software (select models only) .....	26
Using HP Wireless Assistant software .....	27
Using a WLAN .....	27
Setting up a WLAN .....	28
Protecting your WLAN .....	28
Connecting to a WLAN .....	29
Roaming to another network .....	30
Using HP Mobile Broadband (select models only) .....	31
Inserting a SIM .....	31
Removing a SIM .....	32
Using the HP Mobile Broadband Setup Utility (select models only) .....	34

### 4 Multimedia

Multimedia features .....	35
Identifying your multimedia components .....	35
Adjusting the volume .....	37
Multimedia software .....	38
Using other preinstalled multimedia software .....	38

Installing multimedia software from the Internet .....	38
Audio .....	39
Connecting external audio devices .....	39
Checking your audio functions .....	39
Video .....	41
Connecting an external monitor or projector .....	41
Webcam .....	42

## 5 Security

Protecting the device .....	43
Using passwords .....	43
Passwords set in Windows .....	44
Passwords set in Setup Utility .....	44
Administrator password .....	45
Managing an administrator password .....	45
Entering an administrator password .....	45
Power-on password .....	45
Managing a power-on password .....	46
Entering a power-on password .....	46
Using antivirus software .....	47
Using firewall software .....	48
Installing critical updates .....	49

## 6 Digital cards

Inserting a digital card .....	50
Stopping and removing a digital card .....	51

## 7 USB devices

Using a USB device .....	52
Connecting a USB device .....	52
Stopping and removing a USB device .....	53

## 8 Pointing devices and keyboard

Setting pointing device preferences .....	54
Using pointing devices .....	54
Using the TouchPad .....	54
Connecting an external mouse .....	54
Using the keyboard .....	54
Using hotkeys .....	54
Initiating Standby (fn+f1) .....	55
Switching the screen image (fn+f2) .....	56
Decreasing screen brightness (fn+f3) .....	56
Increasing screen brightness (fn+f4) .....	56

Initiating QuickLock (fn+f6) .....	56
Muting speaker sound (fn+f8) .....	57
Decreasing speaker sound (fn+f10) .....	57
Increasing speaker sound (fn+f11) .....	57

## 9 Drives

Identifying installed drives .....	58
Handling drives .....	58
Using external drives .....	59
Using optional external devices .....	59

## 10 Memory modules

## 11 Updating software

Updating the BIOS .....	65
Determining the BIOS version .....	65
Downloading a BIOS update .....	65
Updating programs and drivers .....	67

## 12 Setup Utility

Starting the Setup Utility .....	68
Using the Setup Utility .....	68
Changing the language of the Setup Utility .....	68
Navigating and selecting in the Setup Utility .....	68
Displaying system information .....	69
Restoring default settings in the Setup Utility .....	69
Exiting the Setup Utility .....	69
Setup Utility menus .....	70
Main menu .....	70
Security menu .....	70
System Configuration menu .....	70
Diagnostics menu .....	71

<b>Index .....</b>	<b>72</b>
--------------------	-----------



# 1 Knowing the parts

## Identifying the hardware

Components included with the device may vary by region and model. The illustrations in this chapter identify the standard features on most device models.

To see a list of hardware installed in the device, follow these steps:

1. Select **Start > My Computer**.
2. In the left pane of the System Tasks window, select **View system information**.
3. Select **Hardware** tab > **Device Manager**.

You can also add hardware or modify device configurations using Device Manager.

## Top components

### TouchPad

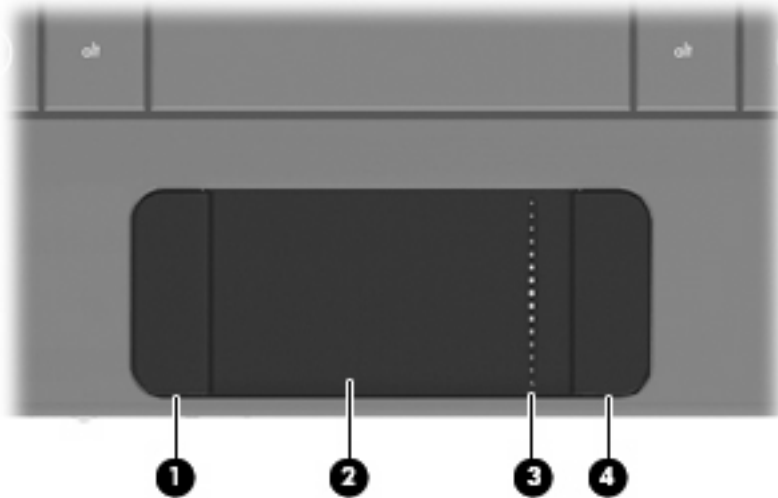

Component	Description
(1) Left TouchPad button*	Functions like the left button on an external mouse.
(2) TouchPad*	Moves the pointer and selects or activates items on the screen.
(3) TouchPad scroll zone	Scrolls up or down.

(4)	Right TouchPad button*	Functions like the right button on an external mouse.
-----	------------------------	---

\*This table describes factory settings. To view or change pointing device preferences, select **Start > Control Panel > Printers and Other Hardware > Mouse**.

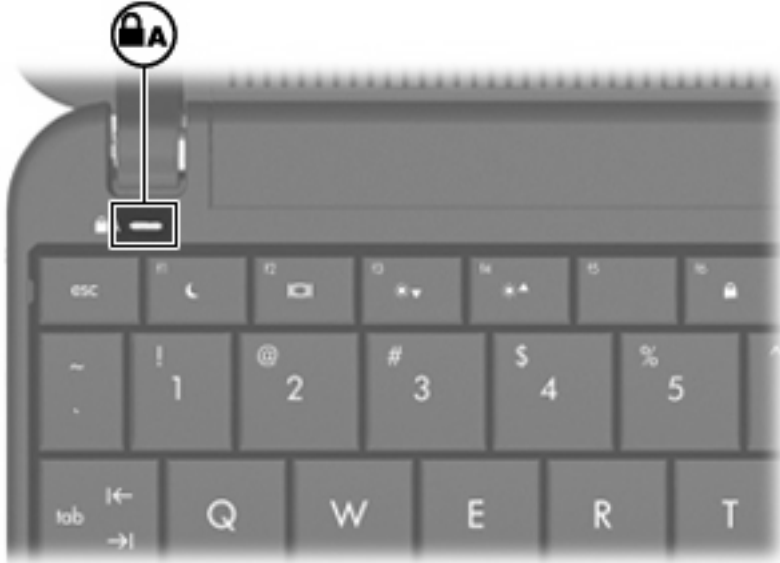

## Light



Component	Description
Caps lock light	On: Caps lock is on.

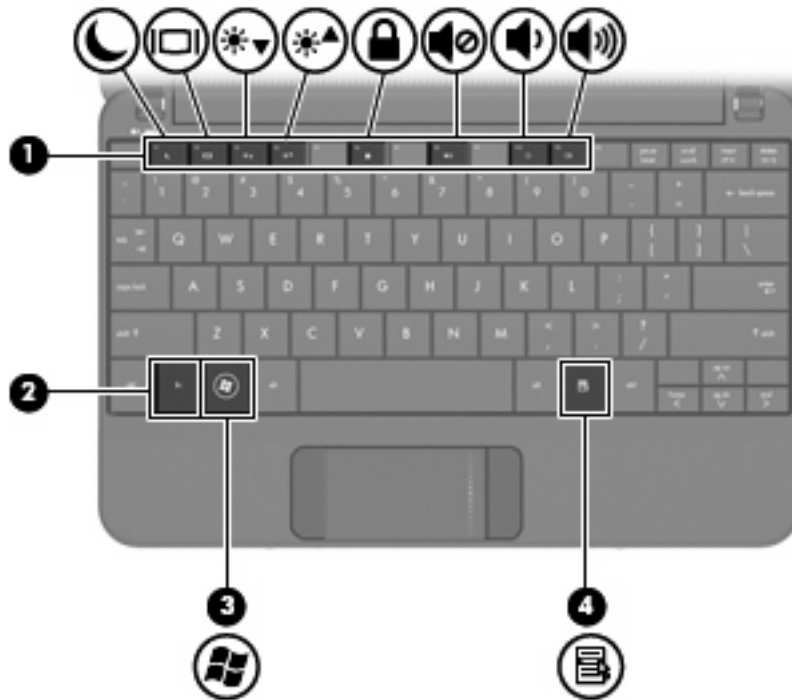



## Keys

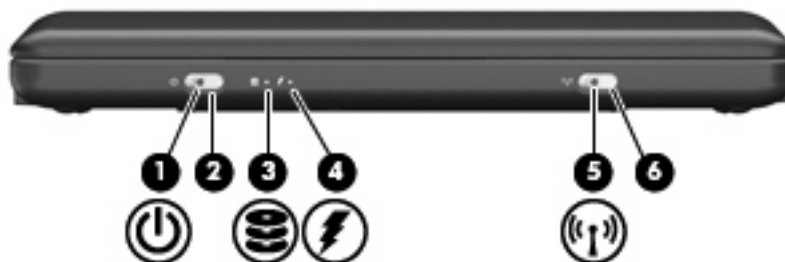

Component	Description
(1) Function keys	Execute frequently used system functions when pressed in combination with the <b>fn</b> key.
(2) <b>fn</b> key	Executes frequently used system functions when pressed in combination with a function key.
(3)  Windows® logo key	Displays the Windows Start menu.
(4)  Windows applications key	Displays a shortcut menu for items beneath the pointer.





## Front components

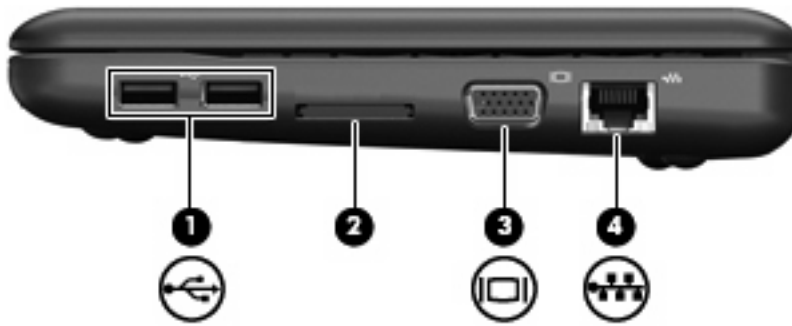

Component	Description
(1)  Power light	<ul style="list-style-type: none"> <li>On: The device is on.</li> <li>Blinking: The device is in Standby.</li> <li>Off: The device is off or in Hibernation.</li> </ul>
(2) Power switch	<ul style="list-style-type: none"> <li>When the device is off, slide the switch to turn on the device.</li> <li>When the device is on, briefly slide the switch to initiate Hibernation.</li> <li>When the device is in Standby, briefly slide the switch to exit Standby.</li> <li>When the device is in Hibernation, briefly slide the switch to exit Hibernation.</li> </ul> <p>If the device has stopped responding and Windows shutdown procedures are ineffective, slide and hold the power switch for at least 5 seconds to turn off the device.</p> <p>To learn more about your power settings, select <b>Start &gt; Control Panel &gt; Performance and Maintenance &gt; Power Options</b>.</p>
(3)  Drive light	Blinking: The hard drive or flash drive is being accessed.
(4)  Battery light	<ul style="list-style-type: none"> <li>On: A battery is charging.</li> <li>Blinking: A battery that is the only available power source has reached a low battery level. When the battery reaches a critical battery level, the battery light begins blinking rapidly.</li> <li>Off: If the device is plugged into an external power source, the light turns off when all batteries in the device are fully charged. If the device is not plugged into an external power source, the light stays off until the battery reaches a low battery level.</li> </ul>
(5)  Wireless light	<ul style="list-style-type: none"> <li>Blue: An integrated wireless device, such as a wireless local area network (WLAN) device, is on.</li> <li>Amber: All wireless devices are off.</li> </ul>
(6) Wireless switch	<p>Turns the wireless feature on or off, but does not establish a wireless connection.</p> <p><b>NOTE:</b> A wireless network must be set up in order to establish a wireless connection.</p>

## Right-side components



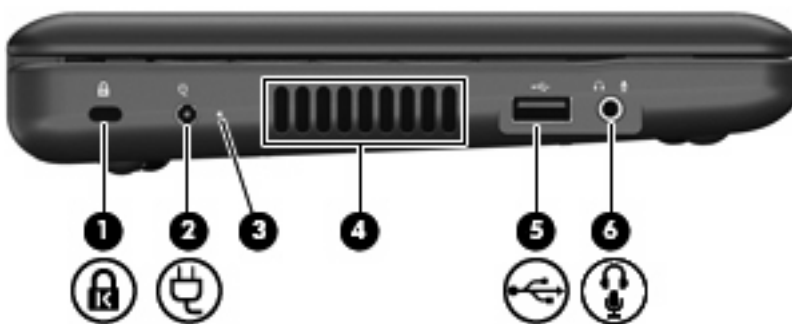

Component	Description
(1)  USB ports (2)	Connect optional USB devices.
(2)  Digital Media Slot	Supports the following optional digital card formats: <ul style="list-style-type: none"> <li>• Memory Stick (MS)</li> <li>• MS/Pro</li> <li>• MultiMediaCard (MMC)</li> <li>• Secure Digital (SD) Memory Card</li> <li>• xD-Picture card</li> </ul>
(3)  External monitor port	Connects an optional external display, such as a monitor or projector, to the device.
(4)  RJ-45 (network) jack	Connects a network cable.

## Left-side components



Component	Description
(1)  Security cable slot	Attaches an optional security cable to the device.  <b>NOTE:</b> The security cable is designed to act as a deterrent, but it may not prevent the device from being mishandled or stolen.

Component	Description
(2)  Power connector	Connects an AC adapter.
(3) AC adapter light	On: The computer is connected to external power. Off: The computer is not connected to external power.
(4) Vent	Enables airflow to cool internal components.  <b>NOTE:</b> The device fan starts up automatically to cool internal components and prevent overheating. It is normal for the internal fan to cycle on and off during routine operation.
(5)  USB port	Connects an optional USB device.
(6)  Audio-out (headphone) jack/Audio-in (microphone) jack	Produces sound when connected to optional powered stereo speakers, headphones, earbuds, a headset, or television audio. Also connects an optional headset microphone.  <b>WARNING!</b> To reduce the risk of personal injury, adjust the volume before putting on headphones, earbuds, or a headset. For additional safety information, refer to the <i>Regulatory, Safety and Environmental Notices</i> .  <b>NOTE:</b> When an audio component is connected to the jack, the device speakers are disabled.  The audio component cable must have a 4-conductor connector.

## Display components

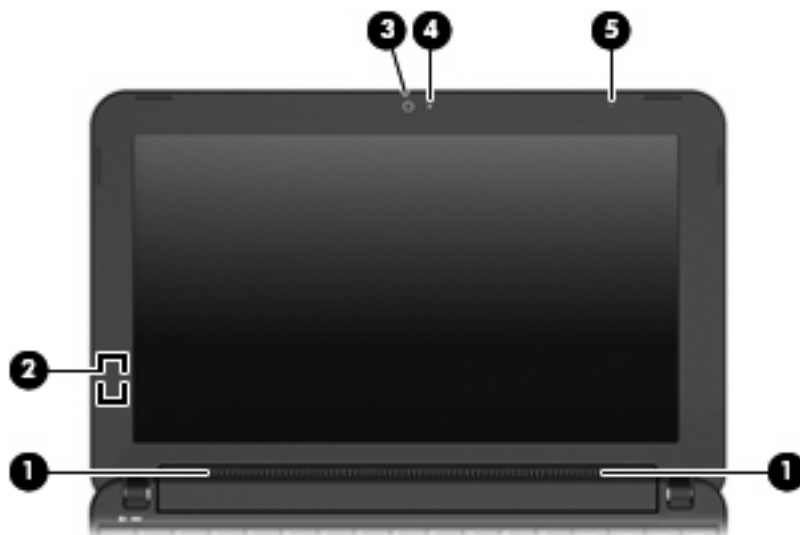

Component	Description
(1) Speakers (2)	Produce sound.

Component	Description
(2) Internal display switch	Turns off the display if the display is closed while the power is on.  <b>NOTE:</b> The display switch is not visible from the outside of the device.
(3) Webcam	Captures still photographs and videos.  <b>NOTE:</b> To capture videos, you need to install additional webcam software.
(4) Webcam light	On: The webcam is in use.
(5) Internal microphone	Records sound.

## Bottom components

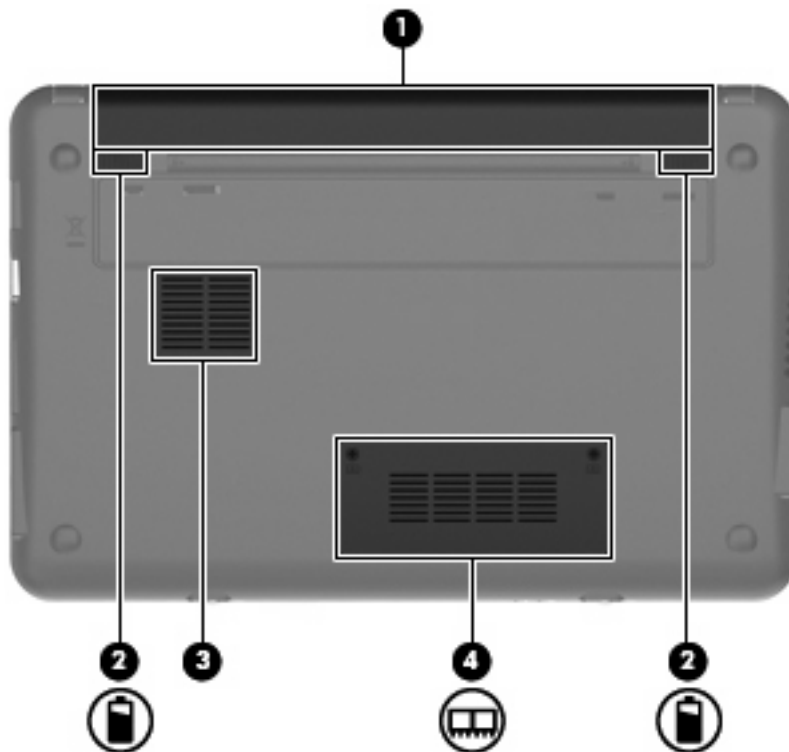

Component	Description
(1) Battery bay	Holds the battery.
(2)  Battery release latches (2)	Release the battery from the battery bay.

Component	Description
(3) Vent	Enables airflow to cool internal components.  <b>NOTE:</b> The device fan starts up automatically to cool internal components and prevent overheating. It is normal for the internal fan to cycle on and off during routine operation.
(4)  Memory module compartment	Contains the memory module slot.

## Wireless antennas

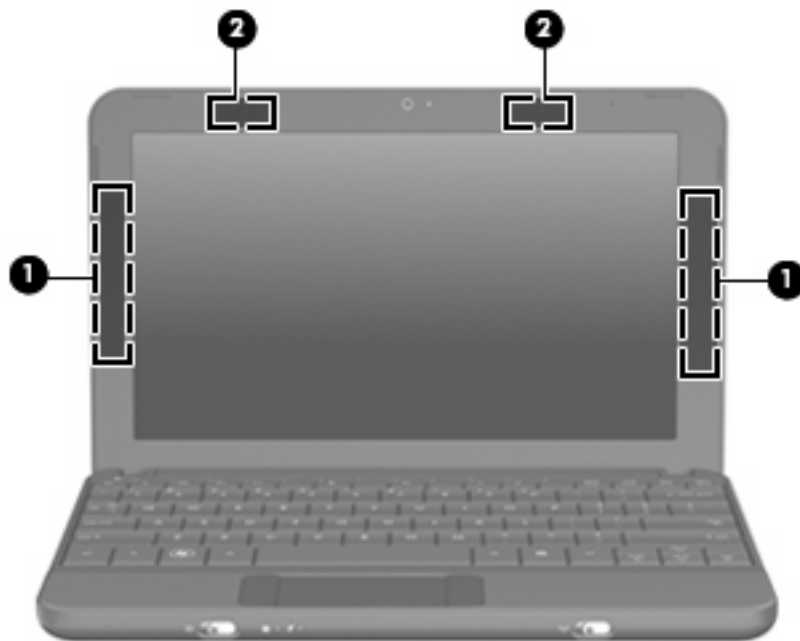

Component	Description
(1) WWAN antennas (2) (select models only)*	Send and receive wireless signals to communicate with wireless wide-area networks (WWANs).
(2) WLAN antennas (2)*	Send and receive wireless signals to communicate with wireless local area networks (WLANs).

\*The antennas are not visible from the outside of the device. For optimal transmission, keep the areas immediately around the antennas free from obstructions.

To see wireless regulatory notices, refer to the section of the *Regulatory, Safety and Environmental Notices* that applies to your country or region. To access these notices, click **Start > Help and Support > User Guides**.



## Additional hardware components



Component	Description
(1) Power cord*	Connects an AC adapter to an AC outlet.
(2) AC adapter	Converts AC power to DC power.
(3) Battery*	Powers the device when the device is not plugged into external power.

\*Batteries and power cords vary in appearance by region and country.

## Identifying the labels

The labels affixed to the device provide information you may need when you troubleshoot system problems or travel internationally with the device.

- Service tag—Provides important information including the following:

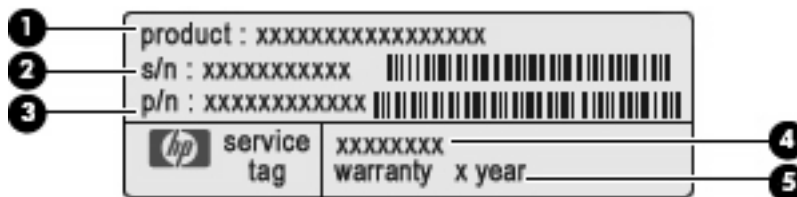

- Product name **(1)**. This is the product name affixed to the front of your device.
- Serial number (s/n) **(2)**. This is an alphanumeric identifier that is unique to each product.
- Part Number/Product number (p/n) **(3)**. This number provides specific information about the hardware components of the product. The part number helps a service technician to determine what components and parts are needed.
- Model description **(4)**. This is the alphanumeric identifier you use to locate documents, drivers, and support for your device.
- Warranty period **(5)**. This number describes the duration (in years) of the warranty period for this device.

Have this information available when you contact technical support. The service tag label is affixed to the bottom of the device.

- Microsoft® Certificate of Authenticity—Contains the Windows® Product Key. You may need the Product Key to update or troubleshoot the operating system. This certificate is affixed to the bottom of the device.
- Regulatory label—Provides regulatory information about the device, including the following:
  - Information about optional wireless devices and the approval markings of some of the countries or regions in which the devices have been approved for use. An optional device may be a wireless local area network (WLAN) device. You may need this information when traveling internationally.
  - The serial number of your HP Mobile Broadband Module (select models only).

The regulatory label is affixed to the bottom of the device.

---

## 2 Power management

### Setting power options

#### Using power-saving states

The device has two power-saving states enabled at the factory: Standby and Hibernation.

When Standby is initiated, the power light blinks and the screen clears. Your work is saved to memory. Exiting Standby is faster than exiting Hibernation. If the device is in Standby for an extended period or if the battery reaches a critical battery level while in Standby, the device initiates Hibernation.

When Hibernation is initiated, your work is saved to a hibernation file on the hard drive and the device turns off.

---

△ **CAUTION:** To prevent possible audio and video degradation, loss of audio or video playback functionality, or loss of information, do not initiate Standby or Hibernation while reading from or writing to a disc or an external media card.

📝 **NOTE:** You cannot initiate any type of networking connection or perform any device functions while the device is in Standby or in Hibernation.

---

#### Initiating and exiting Standby

The system is set at the factory to initiate Standby after 10 minutes of inactivity when running on battery power and 25 minutes of inactivity when running on external power.

Power settings and timeouts can be changed using Power Options in Windows Control Panel.

With the device on, you can initiate Standby in any of the following ways:

- Press **fn+f1**.
- Click **Start > Turn Off Computer > Stand By**.

To exit Standby:

- ▲ Briefly slide the power switch.

When the device exits Standby, the power light turns on and your work returns to the screen where you stopped working.

---

📝 **NOTE:** If you have set a password to be required when the device exits Standby, you must enter your Windows password before your work will return to the screen.

---

## Initiating and exiting Hibernation

The system is set at the factory to initiate Hibernation after 30 minutes of inactivity when running on battery power or when the battery reaches a critical battery level.

---

 **NOTE:** The system will not initiate Hibernation when running on external power.

---

**NOTE:** To reduce the risk of information loss, periodically save your work.

---

Power settings and timeouts can be changed using Power Options in Windows Control Panel.

To initiate Hibernation:

1. Select **Start > Turn Off Computer**.
2. Hold down the **shift** key and select **Hibernate**.

– or –

- ▲ If the device is on, briefly slide the power switch.

To exit Hibernation:

- ▲ Briefly slide the power switch.

When the device exits Hibernation, the power light turns on and your work returns to the screen where you stopped working.

---

 **NOTE:** If you have set a password to be required when the device exits Hibernation, you must enter your Windows password before your work will return to the screen.

---

## Using power schemes

A power scheme is a collection of system settings that manages how the device uses power. Power schemes can help you conserve power and maximize device performance.

The following power schemes are available:

- Portable/Laptop (recommended)
- Home/Office Desk
- Presentation
- Always On
- Minimal Power Management
- Max Battery

You can change the settings of these power plans through Power Options.

## Viewing the current scheme

- ▲ Click the **Power Meter** icon in the notification area, at the far right of the taskbar.

– or –

Select **Start > Control Panel > Performance and Maintenance > Power Options**.

## Selecting a different power scheme

- ▲ Click the **Power Meter** icon in the notification area, at the far right of the taskbar, and then select a power scheme from the list.

– or –

- Select **Start > Control Panel > Performance and Maintenance > Power Options**.
- Select a power scheme from the **Power schemes** list.
- Click **OK**.

## Customizing power schemes

- Select **Start > Control Panel > Performance and Maintenance > Power Options**.
- Select a power scheme from the **Power schemes** list.
- Modify the **Plugged in** and **Running on batteries settings** as needed.
- Click **OK**.

## Setting password protection upon exiting Standby

To set the device to prompt for a password when the device exits Standby, follow these steps:

- Right-click the **Power Meter** icon in the notification area, and then click **Adjust Power Properties**.
- Click the **Advanced** tab.
- Select the **Prompt for password when computer resumes from standby** check box.
- Click **Apply**.

## Using external AC power

External AC power is supplied through one of the following devices:

- △ **WARNING!** To reduce potential safety issues, use only the AC adapter provided with the device, a replacement AC adapter provided by HP, or a compatible AC adapter purchased from HP.

- Approved AC adapter
- Optional docking device or optional expansion product

Connect the device to external AC power under any of the following conditions:

- △ **WARNING!** Do not charge the device battery while you are onboard aircraft.

- When you are charging or calibrating a battery
- When you are installing or modifying system software
- When you are writing information to a CD or DVD

When you connect the device to external AC power, the following events occur:

- The battery begins to charge.
- If the device is turned on, the battery meter icon in the notification area changes appearance.

When you disconnect external AC power, the following events occur:

- The device switches to battery power.
- The display brightness is automatically decreased to save battery life. To increase display brightness, press the **fn+f4** hotkey or reconnect the AC adapter.

## Connecting the AC adapter

**⚠ WARNING!** To reduce the risk of electric shock or damage to the equipment:

Plug the power cord into an AC outlet that is easily accessible at all times.

Disconnect power from the device by unplugging the power cord from the AC outlet (not by unplugging the power cord from the device).

If provided with a 3-pin attachment plug on the power cord, plug the cord into a grounded (earthed) 3-pin outlet. Do not disable the power cord grounding pin, for example, by attaching a 2-pin adapter. The grounding pin is an important safety feature.

To connect the device to external AC power, follow these steps:

1. Plug the AC adapter into the power connector **(1)** on the device.
2. Plug the power cord into the AC adapter **(2)**.
3. Plug the other end of the power cord into an AC outlet **(3)**.

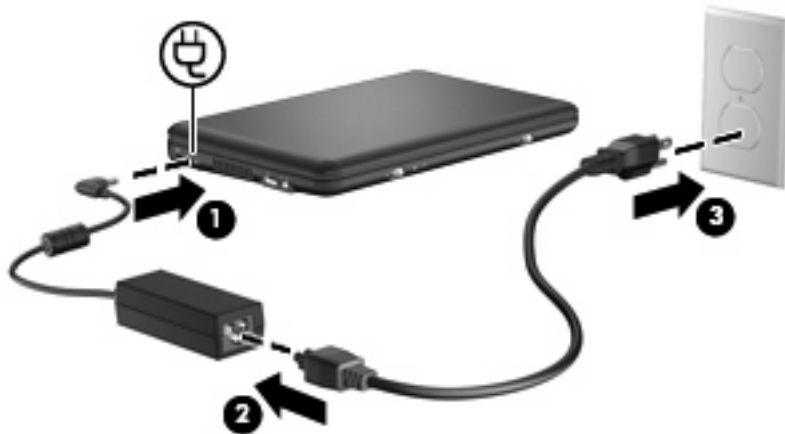

## Using battery power

When a charged battery is in the device and the device is not plugged into external power, the device runs on battery power. When the device is plugged into external AC power, the device runs on AC power.

If the device contains a charged battery and is running on external AC power supplied through the AC adapter, the device switches to battery power if the AC adapter is disconnected from the device.

---

 **NOTE:** The display brightness is decreased to save battery life when you disconnect AC power. To increase display brightness, use the **fn+f4** hotkey or reconnect the AC adapter.

---

You can keep a battery in the device or in storage, depending on how you work. Keeping the battery in the device whenever the device is plugged into AC power charges the battery and also protects your work in case of a power outage. However, a battery in the device slowly discharges when the device is off and unplugged from external power.

---

 **WARNING!** To reduce potential safety issues, use only the battery provided with the device, a replacement battery provided by HP, or a compatible battery purchased from HP.

---

Device battery life varies, depending on power management settings, programs running on the device, display brightness, external devices connected to the device, and other factors.

## Displaying the remaining battery charge

 Double-click the **Power Meter** icon in the notification area, at the far right of the taskbar.

– or –

Select **Start > Control Panel > Performance and Maintenance > Power Options > Power Meter** tab.

Most charge indicators report battery status as both a percentage and as the number of minutes of charge remaining:

- The percentage indicates the approximate amount of charge remaining in the battery.
- The time indicates the approximate running time remaining on the battery *if the battery continues to provide power at the current level*. For example, the time remaining will decrease when a DVD is playing and will increase when a DVD stops playing.

When a battery is charging, a lightning bolt icon may be superimposed over the battery icon on the Power Meter screen.

## Inserting or removing the battery

---

 **CAUTION:** Removing a battery that is the sole power source may cause loss of information. To prevent loss of information, save your work and initiate Hibernation or shut down the device through Windows before removing the battery.

---

To insert the battery:

1. Disconnect all external devices.
2. If the device is connected to AC power, unplug the power cord from the AC outlet.
3. Turn the device upside down on a flat surface.

4. Align the tabs on the battery with the notches on the device, and then insert the battery into the battery bay. The battery release latches automatically lock the battery into place.

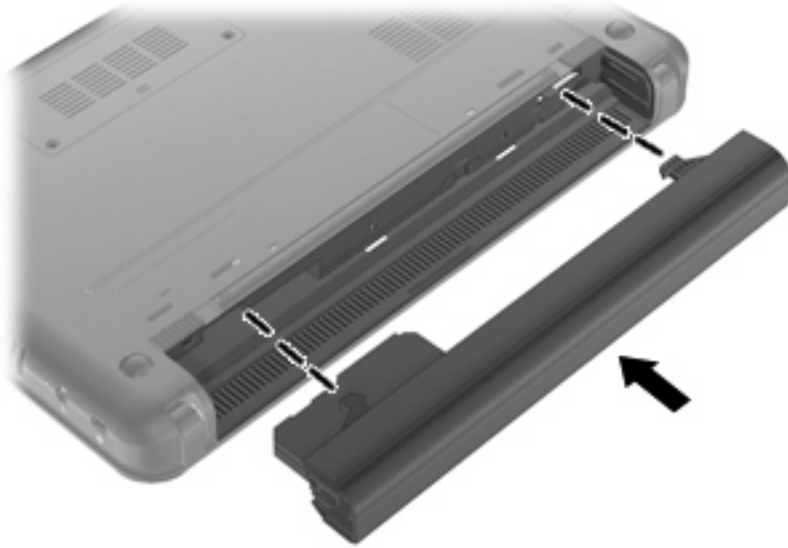

To remove the battery:

1. Disconnect all external devices.
2. If the device is connected to AC power, unplug the power cord from the AC outlet.
3. Turn the device upside down on a flat surface.
4. Slide the battery release latches (1) to release the battery, and then remove the battery (2).

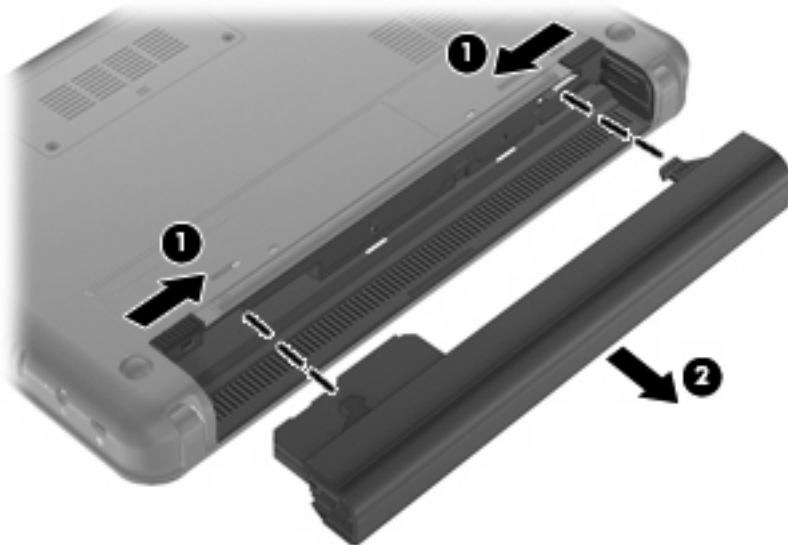

## Charging a battery

**⚠ WARNING!** Do not charge the device battery while you are onboard aircraft.

The battery charges whenever the device is plugged into external power through an AC adapter, an optional power adapter, an optional docking device, or an optional expansion product.



The battery charges whether the device is off or in use, but it charges faster when the device is off.

Charging may take longer if a battery is new, has been unused for 2 weeks or more, or is much warmer or cooler than room temperature.

To prolong battery life and optimize the accuracy of battery charge displays, follow these recommendations:

- If you are charging a new battery, charge it fully before turning on the device.
- Charge the battery until the battery light turns off.

---

 **NOTE:** If the device is on while the battery is charging, the battery meter in the notification area may show 100 percent charge before the battery is fully charged.

---

- Allow the battery to discharge below 5 percent of a full charge through normal use before charging it.
- If the battery has been unused for one month or more, calibrate the battery instead of simply charging it.

The battery light displays charge status:

- On: The battery is charging.
- Blinking: The battery that is the only available power source has reached a low battery level. When the battery reaches a critical battery level, the battery light begins blinking rapidly.
- Off: The battery is fully charged, in use, or not installed.

## Maximizing battery discharge time

Battery discharge time varies depending on the features you use while on battery power. Maximum discharge time gradually shortens, as the battery storage capacity naturally degrades.

Tips for maximizing battery discharge time:

- Decrease the brightness on the display.
- Remove the battery from the device when it is not being used or charged.
- Store the battery in a cool, dry location.

## Managing low battery levels

The information in this section describes the alerts and system responses set at the factory. Some low-battery alerts and system responses can be changed using Power Options in Windows Control Panel. Preferences set using Power Options do not affect lights.

### Identifying low battery levels

When a battery that is the sole power source for the device reaches a low battery level, the battery light blinks.

If a low battery level is not resolved, the device enters a critical battery level, and the battery light blinks rapidly.

The device takes the following actions for a critical battery level:

- If Hibernation is enabled and the device is on or in Standby, the device initiates Hibernation.
- If Hibernation is disabled and the device is on or in Standby, the device remains briefly in Standby, and then shuts down and loses any unsaved information.

## Resolving a low battery level

 **CAUTION:** To reduce the risk of losing information when the device reaches a critical battery level and has initiated Hibernation, do not restore power until the power lights turn off.

---

### Resolving a low battery level when external power is available

- ▲ Connect one of the following devices:
  - AC adapter
  - Optional expansion product or docking device
  - Optional power adapter

### Resolving a low battery level when a charged battery is available

1. Turn off the device or initiate Hibernation.
2. Remove the discharged battery, and then insert a charged battery.
3. Turn on the device.

### Resolving a low battery level when no power source is available

- ▲ Initiate Hibernation.  
– or –  
Save your work and shut down the device.

### Resolving a low battery level when the device cannot exit Hibernation

When the device lacks sufficient power to exit Hibernation, follow these steps:

1. Insert a charged battery or plug the device into external power.
2. Exit Hibernation by briefly sliding the power switch.

## Calibrating a battery

Calibrate a battery under the following conditions:

- When battery charge displays seem inaccurate
- When you observe a significant change in battery run time

Even if a battery is heavily used, it should not need to be calibrated more than once a month. It is also not necessary to calibrate a new battery.

### Step 1: Fully charge the battery

 **WARNING!** Do not charge the device battery while you are onboard aircraft.

 **NOTE:** The battery charges whether the device is off or in use, but it charges faster when the device is off.

---

To fully charge the battery:

1. Insert the battery into the device.
2. Connect the device to an AC adapter, optional power adapter, optional expansion product, or optional docking device, and then plug the adapter or device into external power.

The battery light on the device turns on.

3. Leave the device plugged into external power until the battery is fully charged.

The battery light on the device turns off.

## Step 2: Disable Hibernation and Standby

1. Right-click the **Power Meter** icon in the notification area, at the far right of the taskbar, and then click **Adjust Power Properties**.

– or –

Select **Start > Control Panel > Performance and Maintenance > Power Options**.

2. Record the 4 settings listed in the **Running on batteries** column and the **Plugged in** column so that you can reset them after the calibration.
3. Set the 4 options to **Never**.
4. Click **OK**.

## Step 3: Discharge the battery

The device must remain on while the battery is being discharged. The battery can discharge whether or not you are using the device, but the battery will discharge faster while you are using it.

- If you plan to leave the device unattended during the discharge, save your information before beginning the discharge procedure.
- If you use the device occasionally during the discharge procedure and have set energy-saving timeouts, expect the following performance from the system during the discharge process:
  - The monitor will not turn off automatically.
  - Hard drive speed will not decrease automatically when the device is idle.
  - System-initiated Hibernation will not occur.

To discharge a battery:

1. Unplug the device from its external power source, but do *not* turn off the device.
2. Run the device on battery power until the battery is discharged. The battery light begins to blink when the battery has discharged to a low battery level. When the battery is discharged, the battery light turns off and the device shuts down.

## Step 4: Fully recharge the battery

To recharge the battery:

1. Plug the device into external power and maintain external power until the battery is fully recharged. When the battery is recharged, the battery light on the device turns off.

You can use the device while the battery is recharging, but the battery will charge faster if the device is off.

2. If the device is off, turn it on when the battery is fully charged and the battery light has turned off.

## Step 5: Reenable Hibernation and Standby

 **CAUTION:** Failure to reenable Hibernation after calibration may result in a full battery discharge and information loss if the device reaches a critical battery level.

1. Select **Start > Control Panel > Performance and Maintenance > Power Options**.
2. Reenter the settings that you recorded for the items in the **Plugged in** column and the **Running on batteries** column.
3. Click **OK**.

## Conserving battery power

- Select low power-use settings through Power Options in Windows Control Panel.
- Turn off wireless and local area network (LAN) connections and exit modem applications when you are not using them.
- Disconnect external devices that are not plugged into an external power source, when you are not using them.
- Stop, disable, or remove any external media cards that you are not using.
- Use the **fn+f3** and **fn+f4** hotkeys to adjust screen brightness as needed.
- If you leave your work, initiate Standby or Hibernation, or shut down the device.

## Storing a battery

 **CAUTION:** To prevent damage to a battery, do not expose it to high temperatures for extended periods of time.

If a device will be unused and unplugged from external power for more than 2 weeks, remove the battery and store it separately.

To prolong the charge of a stored battery, place it in a cool, dry place.

 **NOTE:** A stored battery should be checked every 6 months. If the capacity is less than 50 percent, recharge the battery before returning it to storage.

Calibrate a battery before using it if it has been stored for one month or more.

## Disposing of a used battery

 **WARNING!** To reduce the risk of fire or burns, do not disassemble, crush, or puncture; do not short external contacts; do not dispose of in fire or water.

Refer to the *Regulatory, Safety and Environmental Notices* for battery disposal information.

## Shutting down the device

 **CAUTION:** Unsaved information will be lost when the device is shut down.

The Shut Down command closes all open programs, including the operating system, and then turns off the display and device.

Shut down the device under any of the following conditions:

- When you need to replace the battery or access components inside the device
- When you are connecting an external hardware device that does not connect to a USB port
- When the device will be unused and disconnected from external power for an extended period

To shut down the device, follow these steps:

 **NOTE:** If the device is in Standby or in Hibernation, you must first exit Standby or Hibernation before shutdown is possible.

1. Save your work and close all open programs.
2. Select **Start > Turn Off Computer > Turn Off**.

If the device is unresponsive and you are unable to use the preceding shutdown procedures, try the following emergency procedures in the sequence provided:

- Press **ctrl+alt+delete**. Then, click **Shut Down > Turn Off**.
- Slide and hold the power switch for at least 5 seconds.
- Disconnect the device from external power and remove the battery.

---

## 3 Internet

Your device supports the following types of Internet access:

- **Wired**—You can access the Internet by connecting to a broadband network using the RJ-45 (network) jack.
- **Wireless**—For mobile Internet access, you can use a wireless connection. To learn about setting up a wireless network or adding your device to an existing network, refer to the “Connecting to a wireless network” section.

## Connecting to a wired network

Connecting to a local area network (LAN) requires an 8-pin, RJ-45 network cable (purchased separately). If the network cable contains noise suppression circuitry (1), which prevents interference from TV and radio reception, orient the circuitry end of the cable (2) toward the device.



To connect the network cable:

**⚠ WARNING!** To reduce the risk of electric shock, fire, or damage to the equipment, do not plug a modem cable or telephone cable into an RJ-45 (network) jack.

1. Plug the network cable into the network jack (1) on the device.
2. Plug the other end of the cable into a network wall jack (2).

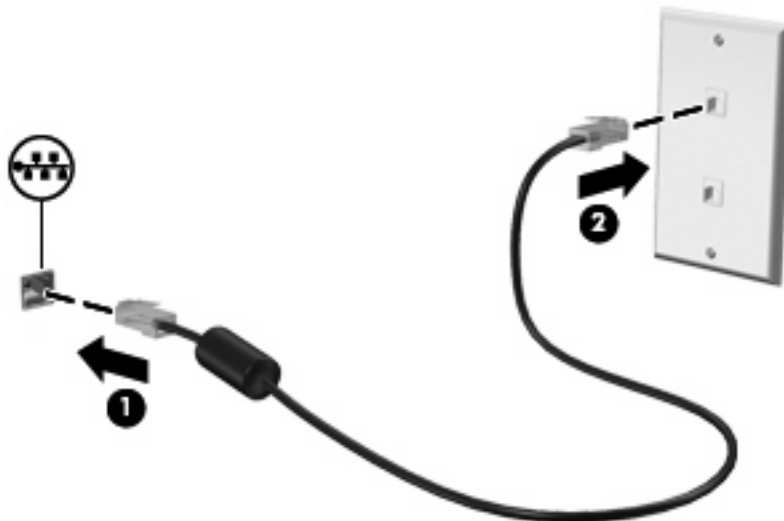



# Connecting to a wireless network

## Using wireless devices

Wireless technology transfers data across radio waves instead of wires. Your device may be equipped with one or more of the following wireless devices:





- **Wireless local area network (WLAN) device**—Connects the device to wireless local area networks (commonly referred to as Wi-Fi networks, wireless LANs, or WLANs) in corporate offices, your home, and public places such as airports, restaurants, coffee shops, hotels, and universities. In a WLAN, each mobile wireless device communicates with a wireless router or a wireless access point.
- **HP Mobile Broadband Module (select models only)**—A wireless wide area network (WWAN) device that provides access to information wherever mobile network operator service is available. In a WWAN, each mobile device communicates to a mobile network operator's base station. Mobile network operators install networks of base stations (similar to cell phone towers) throughout large geographic areas, effectively providing coverage across entire states, regions, or even countries.



The device supports the following IEEE industry standards:

- 802.11b, the first popular standard, supports data rates of up to 11 Mbps and operates at a frequency of 2.4 GHz.
- 802.11g supports data rates of up to 54 Mbps and operates at a frequency of 2.4 GHz. An 802.11g WLAN device is backward compatible with 802.11b devices, so they can operate on the same network.

For more information on wireless technology, refer to the information and Web site links provided in Help and Support.

## Identifying wireless and network status icons

Icon	Name	Description
	Wireless (connected)	Identifies the location of the wireless light and the wireless switch on the device. Also identifies that one or more of the wireless devices are on.
	Wireless (disconnected)	Indicates that all of the wireless devices are off.
	Wireless network connection (connected)	Indicates that one or more of your WLAN devices are connected to the network.
	Wireless network connection (disconnected)	Indicates that one or more of your WLAN devices are not connected to a network.

	Network status (connected)	Indicates that one or more of your LAN drivers are installed and one or more LAN devices are connected to the network.
	Network status (disconnected)	Indicates that one or more of your LAN drivers are installed but no LAN devices are connected to the network.

## Using the wireless controls

You can control the wireless devices in your device using these features:

- Wireless switch
- Operating system controls

## Using the wireless switch

The device has a wireless switch, one or more wireless devices, and one wireless light. All of the wireless devices on your device are enabled at the factory, so the wireless light is on (blue) when you turn on the device.

The wireless light indicates the overall power state of your wireless devices, not the status of individual devices. If the wireless light is blue, at least one wireless device is on. If the wireless light is amber, all wireless devices are off.

Because the wireless devices are enabled at the factory, you can use the wireless switch to turn on or turn off all of the wireless devices simultaneously.

## Using HP Connection Manager software (select models only)

Connection Manager allows you to manage your Internet profiles, SMS (Short Message Service) messaging, connection devices and methods, and edit additional settings.

To start Connection Manager:

1. Click the **HP Connection Manager** icon in the notification area, at the far right of the taskbar.
2. Click **Connect** to turn on the wireless wide area network (WWAN) feature and use HP Mobile Broadband.

 **NOTE:** Connection time varies. After the connection is established, a notification message is displayed in the Connection Manager window.

 **NOTE:** Connection Manager is minimized when first opened. To maximize the Connection Manager window and view more information on connectivity status, click **Details**.

For more details about using Connection Manager, refer to the Connection Manager Help.

## Using HP Wireless Assistant software

A wireless device can be turned on or off using the Wireless Assistant software. If a wireless device is disabled by the Setup Utility, it must be reenabled by the Setup Utility before it can be turned on or off using Wireless Assistant.

---

 **NOTE:** Enabling or turning on a wireless device does not automatically connect the device to a network.

---

To view the state of the wireless devices, position the mouse pointer over the wireless icon in the notification area, at the far right of the taskbar.

---

 **NOTE:** To display the wireless icon, click the **Show hidden icons** icon (< or <<) in the notification area.

---

If the wireless icon is not displayed in the notification area, complete the following steps to change Wireless Assistant properties:

1. Click **Start > Control Panel > Network and Internet Connections > HP Wireless Assistant**.
2. Click **Properties**.
3. Select the check box next to **Wireless Assistant icon in notification area**.
4. Click **Apply**.

For more information, refer to the Wireless Assistant software Help:

1. Open Wireless Assistant by double-clicking the icon in the notification area.
2. Click the **Help** button.

You can use the properties dialog box in Wireless Assistant to show the on/off controls for each installed wireless device and control the devices separately. To show the on/off controls:

1. Double-click the **Wireless Assistant** icon in the notification area, at the far right of the taskbar.
2. Click **Properties**.
3. Select the **Independent controls for installed wireless devices** check box, and then click **Apply**.
4. Click **Turn off** or **Turn on** to control each wireless device separately.

## Using a WLAN

With a WLAN device, you can access a wireless local area network (WLAN), which is composed of other devices and accessories that are linked by a wireless router or a wireless access point.

---

 **NOTE:** The terms *wireless router* and *wireless access point* are often used interchangeably.

---

- A large-scale WLAN, such as a corporate or public WLAN, typically uses wireless access points that can accommodate a large number of devices and accessories and can separate critical network functions.
- A home or small office WLAN typically uses a wireless router, which allows several wireless and wired devices to share an Internet connection, a printer, and files without requiring additional pieces of hardware or software.

To use the WLAN device in your device, you must connect to a WLAN infrastructure (provided through a service provider or a public or corporate network).

## Setting up a WLAN

To set up a WLAN and connect to the Internet, you need the following equipment:

- A broadband modem (either DSL or cable) **(1)** and high-speed Internet service purchased from an Internet service provider (ISP)
- A wireless router (purchased separately) **(2)**
- The wireless device **(3)**

The illustration below shows an example of a wireless network installation that is connected to the Internet.

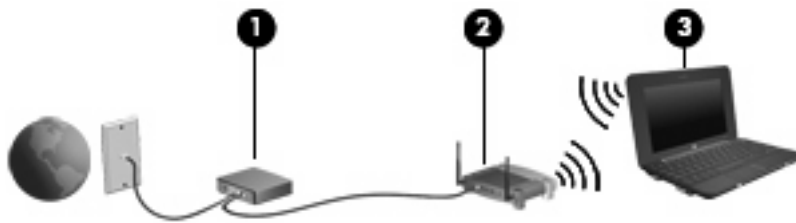

As your network grows, additional wireless and wired devices can be connected to the network to access the Internet.

For help in setting up your WLAN, refer to the information provided by your router manufacturer or your ISP.

## Protecting your WLAN

It is essential to understand that because the WLAN standard was designed with only limited security capabilities—basically to foil casual eavesdropping rather than more powerful forms of attack—WLANs are vulnerable to well-known and well-documented security weaknesses.

WLANs in public areas, or “hotspots,” like coffee shops and airports may not provide any security. New technologies are being developed by wireless manufacturers and hotspot service providers that make the public environment more secure and anonymous. If you are concerned about the security of your device in a hotspot, limit your network activities to noncritical e-mail and basic Internet surfing.

When you set up a WLAN or access an existing WLAN, always enable security features to protect your network from unauthorized access. The common security levels are Wi-Fi Protected Access (WPA)-Personal and Wired Equivalent Privacy (WEP). Because wireless radio signals travel outside the network, other WLAN devices can pick up unprotected signals and either connect to your network

(uninvited) or capture information being sent across it. However, you can take precautions to protect your WLAN:

- **Use a wireless transmitter with built-in security**

Many wireless base stations, gateways, or routers provide built-in security features such as wireless security protocols and firewalls. With the correct wireless transmitter, you can protect your network from the most common wireless security risks.

- **Work behind a firewall**

A firewall is a barrier that checks both data and requests for data that are sent to your network, and discards any suspicious items. Firewalls are available in many varieties, both software and hardware. Some networks use a combination of both types.

- **Use wireless encryption**

A variety of sophisticated encryption protocols is available for your WLAN. Find the solution that works best for your network security:

- **Wired Equivalent Privacy (WEP)** is a wireless security protocol that encodes or encrypts all network data before it is transmitted using a WEP key. Usually, you can allow the network to assign the WEP key. Alternatively, you can set up your own key, generate a different key, or choose other advanced options. Without the correct key, others will not be able to use the WLAN.
- **WPA (Wi-Fi Protected Access)**, like WEP, uses security settings to encrypt and decrypt data that is transmitted over the network. However, instead of using one static security key for encryptions as WEP does, WPA uses “temporal key integrity protocol” (TKIP) to dynamically generate a new key for every packet. It also generates different sets of keys for each device on the network.

- **Close your network**

If possible, prevent your network name (SSID) from being broadcast by the wireless transmitter. Most networks initially broadcast the name, telling any device nearby that your network is available. By closing the network, other devices are less likely to know that your network exists.

 **NOTE:** If your network is closed and the SSID is not broadcast, you will need to know or remember the SSID to connect new devices to the network. Write down the SSID and store it in a secure place before closing the network.

## Connecting to a WLAN

To connect to the WLAN, follow these steps:

1. Be sure that the WLAN device is on. If it is on, the wireless light is blue. If the wireless light is amber, slide the wireless switch.
2. Select **Start > Connect to**.
3. Select your WLAN from the list, and then type the network security key, if required.
  - If the network is unsecured, meaning that anyone can access the network, a warning is displayed. Click **Connect Anyway** to accept the warning and complete the connection.
  - If the network is a security-enabled WLAN, you are prompted to enter a network security key, which is a security code. Type the code, and then click **Connect** to complete the connection.

---

 **NOTE:** If no WLANs are listed, you are out of range of a wireless router or access point.

**NOTE:** If you do not see the network you want to connect to, click **Set up a connection or network**. A list of options is displayed. You can choose to manually search for and connect to a network or to create a new network connection.

---

4. After the connection is made, place the mouse pointer over the wireless network connection icon in the notification area, at the far right of the taskbar, to verify the name, speed, strength, and status of the connection.

 **NOTE:** The functional range (how far your wireless signals travel) depends on WLAN implementation, router manufacturer, and interference from other electronic devices or structural barriers such as walls and floors.

---

More information about using a WLAN is available through the following resources:

- Information from your ISP and the user guides included with your wireless router and other WLAN equipment
- Information and Web site links provided in Help and Support

For a list of public WLANs near you, contact your ISP or search the Web. Web sites that list public WLANs include Cisco Internet Mobile Office Wireless Locations, Hotspotlist, and Geektools. Check with each public WLAN location for cost and connection requirements.

## Roaming to another network

When you move your device within range of another WLAN, Windows attempts to connect to that network. If the attempt is successful, your device is automatically connected to the new network. If Windows does not recognize the new network, follow the same procedure you used initially to connect to your WLAN.

## Using HP Mobile Broadband (select models only)

An HP Mobile Broadband Module is a wireless wide area network (WWAN) device that provides access to information wherever mobile network operator service is available. Using HP Mobile Broadband requires a network service provider (called a *mobile network operator*), which in most cases is a mobile phone network operator. Coverage for HP Mobile Broadband is similar to mobile phone voice coverage.

When used with mobile network operator service, HP Mobile Broadband gives you the freedom to stay connected to the Internet, send e-mail, or connect to your corporate network whether you are on the road or outside the range of Wi-Fi hotspots.

HP Mobile Broadband supports the following technologies:

- HSPA (High Speed Packet Access) module, which provides access to networks based on the Global System for Mobile Communications (GSM) telecommunications standard.
- EV-DO (Evolution Data Optimized), which provides access to networks based on the code division multiple access (CDMA) telecommunications standard.

You may need the HP Mobile Broadband Module serial number to activate mobile broadband service. The serial number is printed on a label inside the battery bay of your device. Some mobile network operators require the use of a subscriber identity module (SIM). A SIM contains basic information about you, such as a personal identification number (PIN), as well as network information. Some devices include a SIM that is preinstalled in the battery bay. If the SIM is not preinstalled, it may be provided in the packet of HP Mobile Broadband information provided with your device, or the mobile network operator may provide it separately from the device.

For information on inserting and removing the SIM, refer to the “Inserting a SIM” and “Removing a SIM” sections in this chapter.

For information on HP Mobile Broadband and how to activate service with a preferred mobile network operator, refer to the HP Mobile Broadband information included with your device. For additional information, see the HP Web site at <http://www.hp.com/go/mobilebroadband> (US only).

### Inserting a SIM

---

△ **CAUTION:** To prevent damage to the connectors, use minimal force when inserting a SIM.

---

To insert a SIM:

1. Shut down the device. If you are not sure whether the device is off or in Hibernation, turn the device on by pressing the power button. Then shut down the device through the operating system.
2. Close the display.
3. Disconnect all external devices connected to the device.
4. Unplug the power cord from the AC outlet.
5. Turn the device upside down on a flat surface, with the battery bay toward you.
6. Remove the battery.

7. Insert the SIM into the SIM slot, and gently push the SIM into the slot until it is firmly seated.

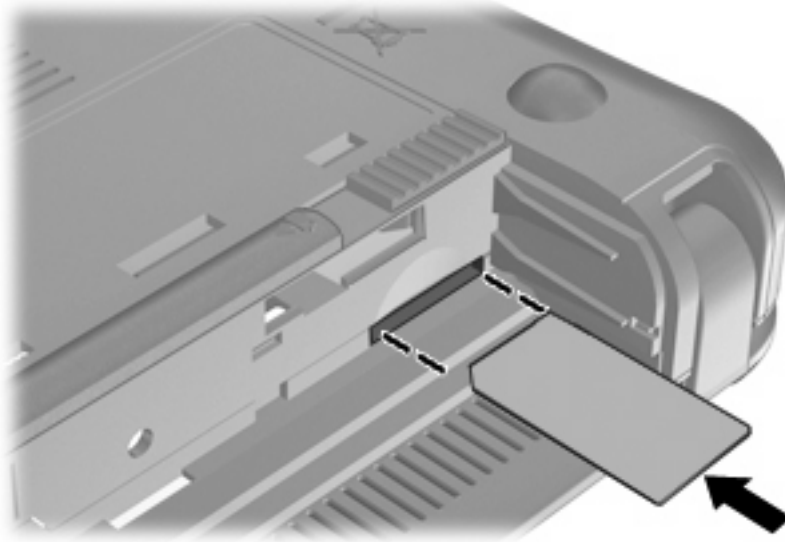

8. Replace the battery.

---

 **NOTE:** HP Mobile Broadband will be disabled if the battery is not replaced.

---

9. Reconnect external power.
10. Reconnect external devices.
11. Turn on the device.

## Removing a SIM

To remove a SIM:

1. Shut down the device. If you are not sure whether the device is off or in Hibernation, turn the device on by pressing the power button. Then shut down the device through the operating system.
2. Close the display.
3. Disconnect all external devices connected to the device.
4. Unplug the power cord from the AC outlet.
5. Turn the device upside down on a flat surface, with the battery bay toward you.
6. Remove the battery.



7. Press in on the SIM (1), and then remove it from the slot (2).

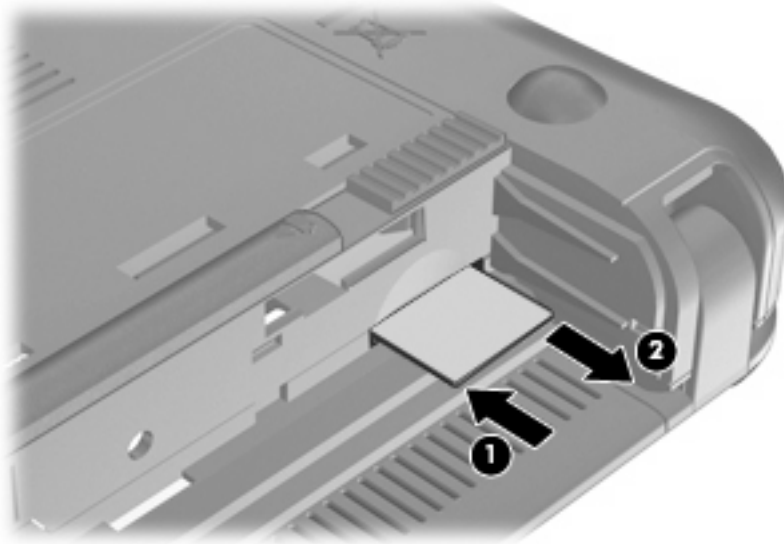

8. Replace the battery.
9. Reconnect external power.
10. Reconnect external devices.
11. Turn on the device.

## Using the HP Mobile Broadband Setup Utility (select models only)

The HP Mobile Broadband Setup Utility provides basic information about setting up HP Mobile Broadband.

---

 **NOTE:** The HP Mobile Broadband Setup Utility is not available in all regions.

---

When you first turn on HP Mobile Broadband, the **Getting Started with HP Mobile Broadband** page opens.

---

# 4 Multimedia

## Multimedia features

Your device includes multimedia features that allow you to listen to music, watch movies, and view pictures. Your device may include the following multimedia components:

- Integrated speakers for listening to music
- Integrated webcam that allows you to capture photographs and videos
- Preinstalled multimedia software that allows you to play and manage your music, movies, and pictures

---

 **NOTE:** Your device may not include all of the components listed.





---

The following sections explain how to identify and use the multimedia components included with your device.

## Identifying your multimedia components

The following illustration and table describe the multimedia features of the device.



Component	Description
(1) Webcam	Captures still photographs and videos.  <b>NOTE:</b> To capture videos, you need to install additional webcam software.
(2) Webcam light	On: The webcam is in use.
(3) Internal microphone	Records sound.
(4) Speakers (2)	Produce sound.
(5)  Volume up hotkey	Increases speaker sound when pressed in combination with the <b>fn</b> key.
(6)  Volume down hotkey	Decreases speaker sound when pressed in combination with the <b>fn</b> key.
(7)  Volume mute hotkey	Mutes speaker sound when pressed in combination with the <b>fn</b> key.
(8)  Audio-out (headphone) jack/Audio-in (microphone) jack	Produces sound when connected to optional powered stereo speakers, headphones, earbuds, a headset, or television audio. Also connects an optional headset microphone.  <b>WARNING!</b> To reduce the risk of personal injury, adjust the volume before putting on headphones, earbuds, or a headset. For additional safety information, refer to the <i>Regulatory, Safety and Environmental Notices</i> .  <b>NOTE:</b> When a device is connected to the jack, the device speakers are disabled.  The audio component must have a 4-conductor connector.

## Adjusting the volume

You can adjust the volume using the following controls:

- Device volume hotkey—A combination of the **fn** key (1) and either the **f8** (2), **f10** (3), or **f11** (4) function key:
  - To mute or restore volume, press **fn+f8**.
  - To decrease volume, press **fn+f10**.
  - To increase volume, press **fn+f11**.

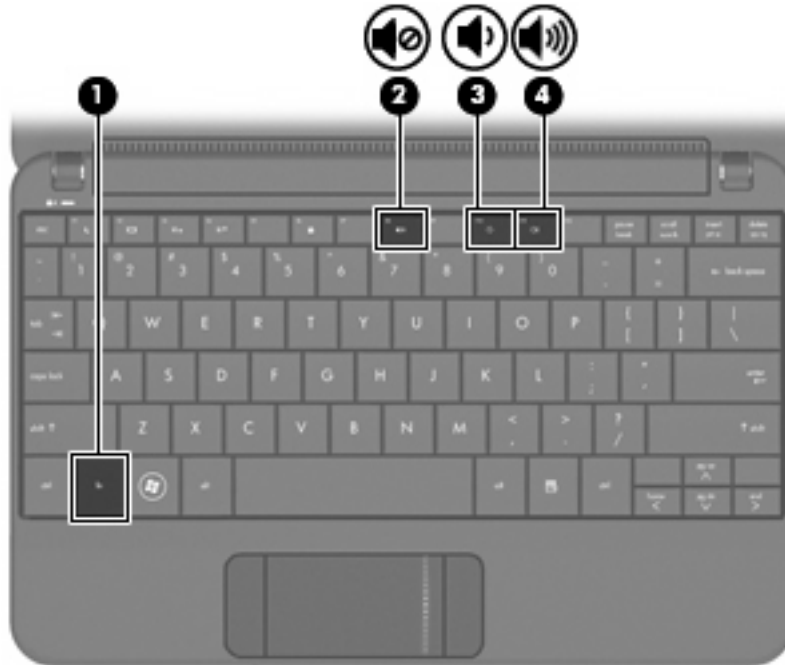

- Windows® volume control:
  - a. Click the **Volume** icon in the notification area, at the far right of the taskbar.
  - b. Increase or decrease the volume by moving the slider up or down. Select the **Mute** check box to mute the volume.– or –
  - a. Double-click the **Volume** icon in the notification area.
  - b. In the Volume Control column, you can increase or decrease the volume by moving the **Volume** slider up or down. You can also adjust the balance or mute the volume.

If the Volume icon is not displayed in the notification area, follow these steps to add it:

- a. Select **Start > Control Panel > Sounds, Speech, and Audio Devices > Sounds and Audio Devices > Volume** tab.
  - b. Select the **Place volume icon in the taskbar** check box.
  - c. Click **Apply**.
- Program volume control:  
Volume can also be adjusted within some programs.

## Multimedia software

Your device includes preinstalled multimedia software that allows you to play music, watch movies, and view pictures.

### Using other preinstalled multimedia software

To locate other preinstalled multimedia software:

- ▲ Select **Start > All Programs**, and then open the multimedia program you want to use. For example, if you want to use Windows Media Player (select models only), click **Windows Media Player**.

---

 **NOTE:** Some programs may be located in subfolders.

---

### Installing multimedia software from the Internet

- ▲ To install multimedia software from the Internet, go to the software manufacturer's Web site and follow the instructions.

---

 **NOTE:** Software downloaded from the Internet may contain viruses. Refer to the "Security" chapter for more information.

---

# Audio

Your device has a variety of audio features that allow you to:

- Play music using your device speakers and/or connected external speakers.
- Record sound using the internal microphone or an optional external headset microphone.
- Download music from the Internet.
- Create multimedia presentations using audio and images.
- Transmit sound and images with instant messaging programs.

## Connecting external audio devices

---

 **WARNING!** To reduce the risk of personal injury, adjust the volume before putting on headphones, earbuds, or a headset. For additional safety information, refer to the *Regulatory, Safety and Environmental Notices*.

---

To connect external devices such as external speakers, headphones, or a headset microphone, refer to the information provided with the device. For best results, remember the following tips:

- Be sure that the device cable has a 4-conductor connector that supports both audio-out (headphone) and audio-in (microphone).
- Be sure that the external device cable is securely connected to the jack on your device.
- Be sure to install any drivers required by the external device.

---

 **NOTE:** A driver is a required program that acts like a translator between the device and the programs that use the device.

---

## Checking your audio functions

To check the system sound on your device, follow these steps:

1. Select **Start > Control Panel > Sounds, Speech, and Audio Devices > Sounds and Audio Devices**.
2. When the Sound and Audio Device Properties window opens, click the **Sounds** tab. Under **Program events**, select any sound event, such as a beep or alarm, and click the arrow button to check the sound.

You should hear sound through the speakers or through connected headphones.

To check the record functions of the device, follow these steps:

1. Select **Start > All Programs > Accessories > Entertainment > Sound Recorder**.
2. Click the record button and speak into the microphone. Save the file to your desktop.
3. Open a multimedia program and play back the sound.

---

 **NOTE:** For best results when recording, speak directly into the microphone and record sound in a setting free of background noise.

---

- ▲ To confirm or change the audio settings on your device, right-click the **Volume** icon on the taskbar, or select **Start > Control Panel > Sounds, Speech, and Audio Devices > Sounds and Audio Devices**.



## Video

Your device enables you to use a variety of video features:

- Watch movies
- Play games over the Internet
- Edit pictures and video to create presentations
- Connect external video devices

### Connecting an external monitor or projector

Use a VGA cable (purchased separately) to connect an external display, such as a monitor or projector, to the external monitor port on the device.

To connect an external monitor or projector:

1. Connect the optional VGA cable to the external monitor port on the device.

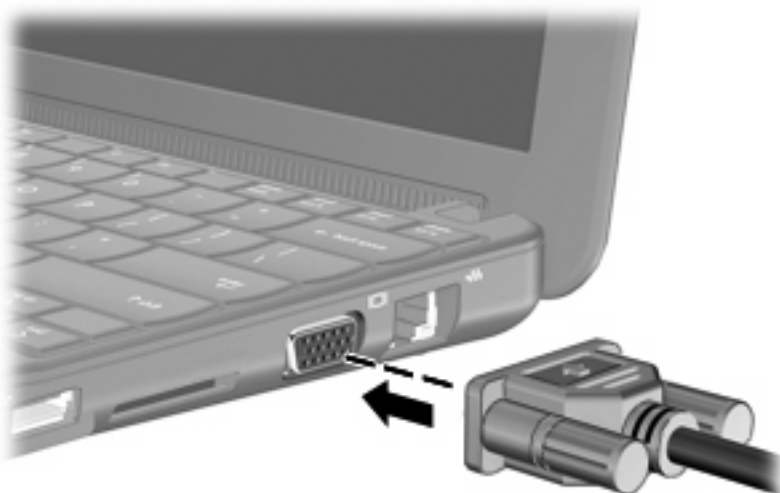

2. Connect the external monitor or projector to the other end of the cable.

 **NOTE:** If a properly connected external monitor or projector does not display a screen image, press **fn+f2** to transfer the image to the external display. Repeatedly pressing **fn+f2** alternates the screen image between the external display and the device.

# Webcam

Your device includes an integrated webcam, located at the top of the display. The webcam is an input device that allows you to capture still photographs and videos.

---

 **NOTE:** To record videos, you need to install additional webcam software.

---

To access the webcam:

1. Click **Start > My Computer**, and then double-click the camera icon.
2. Click **Take a new picture** to take a picture.

---

 **NOTE:** The picture is automatically saved in the My Documents folder.

---

# 5 Security

## Protecting the device

Standard security features provided by the Windows operating system and the non-Windows Setup Utility can protect your personal settings and data from a variety of risks.

Follow the procedures in this chapter to use the following features:

- Passwords
- Firewall software
- Antivirus support (Norton Internet Security)
- Critical security updates

 **NOTE:** Security solutions are designed to act as deterrents, but they may not deter software attacks or prevent the device from being mishandled or stolen.

**NOTE:** Before you send your device for service, remove all password settings.

Device risk	Security feature
Unauthorized use of the device	<ul style="list-style-type: none"><li>• QuickLock</li><li>• Power-on password</li></ul>
Unauthorized access to data	<ul style="list-style-type: none"><li>• Firewall software</li><li>• Windows updates</li></ul>
Unauthorized access to Setup Utility, BIOS settings, and other system identification information	Administrator password
Ongoing or future threats to the device	Critical security updates from Microsoft
Unauthorized access to a Windows user account	User password

## Using passwords

A password is a group of characters that you choose to secure your device information. Several types of passwords can be set, depending on how you want to control access to your information. Passwords can be set in Windows or in the non-Windows Setup Utility preinstalled on the device.

 **CAUTION:** To prevent being locked out of the device, record each password you set. Because most passwords are not displayed as they are set, changed, or deleted, it is essential to record each password immediately and store it in a secure place.

You can use the same password for a Setup Utility feature and for a Windows security feature. You can also use the same password for more than one Setup Utility feature.

Use the following guidelines when setting a password in Setup Utility:

- A password can be any combination of up to 8 letters and numbers and is case sensitive.
- A password set in the Setup Utility must be entered at a Setup Utility prompt. A password set in Windows must be entered at a Windows prompt.

Use the following tips for creating and saving passwords:

- When creating passwords, follow requirements set by the program.
- Write down your passwords and store them in a secure place away from the device.
- Do not store passwords in a file on the device.
- Do not use your name or other personal information that could be easily discovered by an outsider.

The following sections list Windows and Setup Utility passwords and describe their functions. For additional information about Windows passwords, such as screen-saver passwords, select **Start > Help and Support**.

## Passwords set in Windows

Password	Function
Administrator password	Protects administrator-level access to device contents.  <b>NOTE:</b> This password cannot be used to access Setup Utility contents.
User password	Protects access to a Windows user account. It also protects access to the device contents and must be entered when you exit Standby or Hibernation.
QuickLock	Protects the device by requiring a password to be entered in the Windows Log On dialog box before you access the device. After you set a user or administrator password, follow these steps:  <ol style="list-style-type: none"><li>1. Initiate QuickLock by pressing <b>fn+f6</b>.</li><li>2. Exit QuickLock by entering your Windows user or administrator password.</li></ol>

## Passwords set in Setup Utility

Password	Function
Administrator password*	<ul style="list-style-type: none"><li>• Protects access to Setup Utility.</li><li>• After this password is set, it must be entered each time you access Setup Utility.</li></ul> <b>CAUTION:</b> If you forget your administrator password, you cannot access Setup Utility.

Password	Function
Power-on password*	<ul style="list-style-type: none"> <li>Protects access to the device contents.</li> <li>After this password is set, it must be entered each time you turn on or restart the device, or exit Hibernation.</li> </ul> <p><b>CAUTION:</b> If you forget your power-on password, you cannot turn on or restart the device, or exit Hibernation.</p>

\*For details about each of these passwords, refer to the following topics.

## Administrator password

Your administrator password protects the configuration settings and system identification information in Setup Utility. After this password is set, you must enter it each time you access Setup Utility.

Your administrator password is not interchangeable with an administrator password set in Windows, nor is it displayed as it is set, entered, changed, or deleted. Be sure that you record your password and store it in a safe place.

### Managing an administrator password

To set, change, or delete this password, follow these steps:

- Open the Setup Utility by turning on or restarting the device, and then pressing **f10** while the “F10 = BIOS Setup Options” message is displayed in the lower-left corner of the screen.
- Use the arrow keys to select **Security > Set Administrator Password**, and then press **enter**.
  - To set an administrator password, type your password in the **Enter New Password** and **Confirm New Password** fields, and then press **enter**.
  - To change an administrator password, type your current password in the **Enter Current Password** field, type a new password in the **Enter New Password** and **Confirm New Password** fields, and then press **enter**.
  - To delete an administrator password, type your current password in the **Enter Password** field, and then press **enter** 4 times.
- To save your changes and exit the Setup Utility, use the arrow keys to select **Exit > Exit Saving Changes**.

Your changes go into effect when the device restarts.

### Entering an administrator password

At the **Enter Password** prompt, type your administrator password, and then press **enter**. After 3 unsuccessful attempts to enter the administrator password, you must restart the device and try again.

### Power-on password

Your power-on password prevents unauthorized use of the device. After this password is set, it must be entered each time you turn on or restart the device, or exit Hibernation. A power-on password is not displayed as it is set, entered, changed, or deleted.

## Managing a power-on password

To set, change, or delete this password, follow these steps:

1. Open the Setup Utility by turning on or restarting the device, and then pressing **f10** while the “F10 = BIOS Setup Options” message is displayed in the lower-left corner of the screen.
2. Use the arrow keys to select **Security > Set Power-On Password**, and then press **enter**.
  - To set a power-on password, type your password in the **Enter New Password** and **Confirm New Password** fields, and then press **enter**.
  - To change a power-on password, type your current password in the **Enter Current Password** field, type a new password in the **Enter New Password** and **Confirm New Password** fields, and then press **enter**.
  - To delete a power-on password, type your current password in the **Enter Current Password** field, and then press **enter** 4 times.
3. To save your changes and exit the Setup Utility, use the arrow keys to select **Exit > Exit Saving Changes**.

Your changes go into effect when the device restarts.

## Entering a power-on password

At the **Enter Password** prompt, type your password, and then press **enter**. After 3 unsuccessful attempts to enter the password, you must restart the device and try again.

# Using antivirus software

When you use the device for e-mail or Internet access, you expose it to computer viruses that can disable the operating system, programs, or utilities or cause them to function abnormally.

Antivirus software can detect most viruses, destroy them, and in most cases, repair damage they have caused. To provide ongoing protection against newly discovered viruses, antivirus software must be kept up to date.

Norton Internet Security, an antivirus program, is preinstalled on the device.

- Your version of Norton Internet Security includes 60 days of free updates. It is strongly recommended that you protect the device against new viruses beyond 60 days by purchasing extended update service. Instructions for using and updating Norton Internet Security software and for purchasing extended update service are provided within the program.
- To access Norton Internet Security, or to get more information about it, click **Start > All Programs > Norton Internet Security**.

---

 **NOTE:** HP recommends that you always update the antivirus software to help protect your device.

**NOTE:** For more information about computer viruses, type `viruses` in the Search box in Help and Support.

---

## Using firewall software

When you use the device for e-mail, network, or Internet access, unauthorized persons may be able to gain access to the device, your personal files, and information about you. Use the firewall software preinstalled on the device to protect your privacy.

Firewall features include logging and reporting of network activity, and automatic monitoring of all incoming and outgoing traffic. Refer to the firewall user guide or contact your firewall manufacturer for more information.

---

 **NOTE:** Under some circumstances a firewall can block access to Internet games, interfere with printer or file sharing on a network, or block authorized e-mail attachments. To temporarily resolve the problem, disable the firewall, perform the task that you want to perform, and then reenable the firewall. To permanently resolve the problem, reconfigure the firewall.

---



## Installing critical updates

△ **CAUTION:** Microsoft sends alerts regarding critical updates. To protect the device from security breaches and device viruses, install all critical updates from Microsoft as soon as you receive an alert.

Updates to the operating system and other software may have become available after the device was shipped. To be sure that all available updates are installed on the device, observe these guidelines:

- Run Windows Update as soon as possible after you set up your device. Use the update link at **Start > All Programs > Windows Update**.
- Run Windows Update at regular intervals, such as once a month.
- Obtain updates to Windows and other Microsoft programs, as they are released, from the Microsoft Web site and through the updates link in Help and Support.

---

## 6 Digital cards

Optional digital cards provide secure data storage and convenient data sharing. These cards are often used with digital media–equipped cameras and PDAs as well as with other devices.

The Digital Media Slot supports the following formats:

- Memory Stick (MS)
- MS/Pro
- MultiMediaCard (MMC)
- Secure Digital (SD) Memory Card
- xD-Picture card

### Inserting a digital card

△ **CAUTION:** To avoid damaging the digital card or the device, do not insert any type of adapter into the Digital Media Slot.

**CAUTION:** To prevent damage to the digital card connectors, use minimal force to insert a digital card.

1. Hold the digital card label-side up, with the connectors facing the device.
2. Insert the card into the Digital Media Slot, and then push in on the card until it is firmly seated.

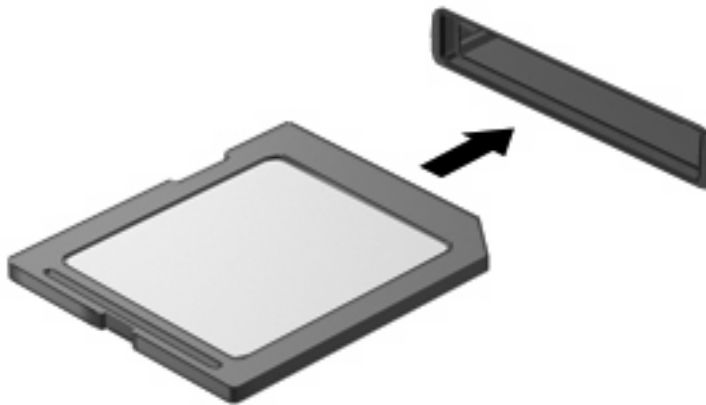

You will hear a sound when the device has been detected, and a menu of options may be displayed.

# Stopping and removing a digital card

△ **CAUTION:** To prevent loss of data or an unresponsive system, stop a digital card before removing it.

1. Save your information and close all programs associated with the digital card.

📝 **NOTE:** To stop a data transfer, click **Cancel** in the operating system Copying window.

2. Stop the digital card:

- a. Double-click the **Safely Remove Hardware** icon in the notification area, at the far right of the taskbar.

📝 **NOTE:** To display the Safely Remove Hardware icon, click the **Show Hidden Icons** icon (< or <<) in the notification area.

- b. Click the name of the digital card in the list.
- c. Click **Stop**, and then click **OK**.

3. Press in on the digital card (1), and then remove the card from the slot (2).

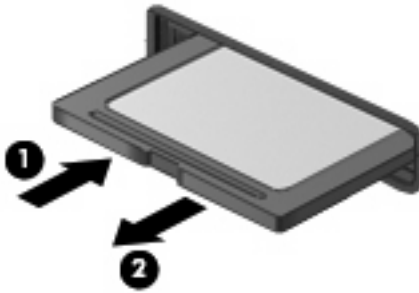

---

# 7 USB devices

## Using a USB device

Universal Serial Bus (USB) is a hardware interface that can be used to connect an optional external device, such as a USB keyboard, mouse, drive, printer, scanner, or hub. Devices can be connected to the system, an optional docking device, or an optional expansion product.

Some USB devices may require additional support software, which is usually included with the device. For more information about device-specific software, refer to the manufacturer's instructions.

The device has 3 USB ports, which support USB 1.0, USB 1.1, and USB 2.0 devices. An optional USB hub, optional docking device, or an optional expansion product provides additional USB ports that can be used with the device.

## Connecting a USB device

---

△ **CAUTION:** To prevent damage to a USB connector, use minimal force to connect a USB device.

▲ To connect a USB device, connect the USB cable for the device to the USB port.



You will hear a sound when the device has been detected.

---

📄 **NOTE:** When you connect a USB device, you may see a message in the notification area to let you know that the device is recognized by the system.

---

## Stopping and removing a USB device

△ **CAUTION:** To prevent loss of information or an unresponsive system, stop a USB device before removing it.

**CAUTION:** To prevent damage to a USB connector, do not pull on the cable to remove the USB device.

To stop and remove a USB device:

1. Double-click the **Safely Remove Hardware** icon in the notification area, at the far right of the taskbar.

 **NOTE:** To display the Safely Remove Hardware icon, click the **Show Hidden Icons** icon (< or <<) in the notification area.

2. Click the name of the device in the list.

 **NOTE:** If the USB device is not listed, you do not have to stop the device before you remove it.

3. Click **Stop**, and then click **OK**.

4. Remove the device.

---

# 8 Pointing devices and keyboard

## Setting pointing device preferences

Use Mouse Properties in Windows® to customize settings for pointing devices, such as button configuration, click speed, and pointer options.

To access Mouse Properties, select **Start > Control Panel > Printers and Other Hardware > Mouse**.

## Using pointing devices

### Using the TouchPad

To move the pointer, slide your finger across the TouchPad surface in the direction you want the pointer to go. Use the TouchPad buttons like the corresponding buttons on an external mouse. To scroll up and down using the TouchPad vertical scroll zone, slide your finger up or down over the lines.

 **NOTE:** If you are using the TouchPad to move the pointer, you must lift your finger off the TouchPad before moving it to the scroll zone. Simply sliding your finger from the TouchPad to the scroll zone will not activate the scrolling function.

---

### Connecting an external mouse

You can connect an external USB mouse to the device using one of the USB ports on the device.

## Using the keyboard

### Using hotkeys

Hotkeys are combinations of the **fn** key **(1)** and one of the function keys **(2)**.

The icons on the **f1** through **f4**, and **f6**, **f8**, **f10**, and **f11** keys represent the hotkey functions. Hotkey functions and procedures are discussed in the following sections.



Function	Hotkey
Initiate Standby.	fn+f1
Switch the image.	fn+f2
Decrease screen brightness.	fn+f3
Increase screen brightness.	fn+f4
Initiate QuickLock.	fn+f6
Mute or restore speaker.	fn+f8
Decrease speaker sound.	fn+f10
Increase speaker sound.	fn+f11

To use a hotkey command on the device keyboard, follow either of these steps:

- Briefly press the **fn** key, and then briefly press the second key of the hotkey command.  
– or –
- Press and hold down the **fn** key, briefly press the second key of the hotkey command, and then release both keys at the same time.

## Initiating Standby (fn+f1)

Press **fn+f1** to initiate Standby.

When Standby is initiated, your information is stored in memory, the screen is cleared, and power is conserved. While the device is in Standby, the power light blinks.

---

△ **CAUTION:** To reduce the risk of information loss, save your work before initiating Standby.

---

The device must be on before you can initiate Standby.

 **NOTE:** If a critical battery level occurs while the device is in Standby, the device initiates Hibernation and the information stored in memory is saved to the hard drive. The factory setting for critical battery action is Hibernate, but this setting can be changed in advanced power settings.

---

To exit Standby, briefly slide the power switch.

The function of the **fn+f1** hotkey can be changed. For example, you can set the **fn+f1** hotkey to initiate Hibernation instead of Standby.

 **NOTE:** In all Windows operating system windows, references to the *sleep button* apply to the **fn+f1** hotkey.

---

## Switching the screen image (fn+f2)

Press **fn+f2** to switch the screen image among display devices connected to the system. For example, if a monitor is connected to the device, pressing **fn+f2** alternates the screen image from device display to monitor display to simultaneous display on both the device and the monitor.

 **NOTE:** You must use a VGA cable (purchased separately) to connect an external display, such as a monitor or projector, to the external monitor port on the device.

---

Most external monitors receive video information from the device using the external VGA video standard. The **fn+f2** hotkey can also alternate images among other devices receiving video information from the device.

The following video transmission types, with examples of devices that use them, are supported by the **fn+f2** hotkey:

- LCD (device display)
- External VGA (most external monitors)

## Decreasing screen brightness (fn+f3)

Press **fn+f3** to decrease screen brightness. Hold down the hotkey to decrease the brightness level incrementally.

## Increasing screen brightness (fn+f4)

Press **fn+f4** to increase screen brightness. Hold down the hotkey to increase the brightness level incrementally.

## Initiating QuickLock (fn+f6)

Press **fn+f6** to initiate the QuickLock security feature.

QuickLock protects your information by displaying the operating system Log On window. While the Log On window is displayed, the device cannot be accessed until a Windows user password or a Windows administrator password is entered.

 **NOTE:** Before you can use QuickLock, you must set a Windows user password or a Windows administrator password. For instructions, refer to Help and Support.

---



To use QuickLock, press **fn+f6** to display the Log On window and lock the device. Then follow the instructions on the screen to enter your Windows user password or your Windows administrator password and access the device.

### **Muting speaker sound (fn+f8)**

Press **fn+f8** to mute speaker sound. Press the hotkey again to restore speaker sound.

### **Decreasing speaker sound (fn+f10)**

Press **fn+f10** to decrease speaker sound. Hold down the hotkey to decrease speaker sound incrementally.

### **Increasing speaker sound (fn+f11)**

Press **fn+f11** to increase speaker sound. Hold down the hotkey to increase speaker sound incrementally.

---

# 9 Drives

## Identifying installed drives

To view the drives installed on the device, select **Start > My Computer**.

## Handling drives

Drives are fragile device components that must be handled with care. Refer to the following cautions before handling drives. Additional cautions are included with the procedures to which they apply.

- △ **CAUTION:** To reduce the risk of damage to the device, damage to a drive, or loss of information, observe these precautions:

Before you move a device that is connected to an external hard drive, initiate Standby and allow the screen to clear, or properly disconnect the external hard drive.

Before handling a drive, discharge static electricity by touching the unpainted metal surface of the drive.

Do not touch the connector pins on a removable drive or on the device.

Handle a drive carefully; do not drop a drive or place items on it.

Before removing or inserting a drive, shut down the device. If you are unsure whether the device is off, in Standby, or in Hibernation, turn the device on and then shut it down through the operating system.

Do not use excessive force when inserting a drive into a drive bay.

Do not type on the keyboard or move the device while an optional optical drive is writing to a disc. The write process is sensitive to vibration.

When the battery is the only source of power, be sure that the battery is sufficiently charged before writing to media.

Avoid exposing a drive to temperature or humidity extremes.

Avoid exposing a drive to liquids. Do not spray the drive with cleaning products.

Remove media from a drive before removing the drive from the drive bay, or traveling with, shipping, or storing a drive.

If a drive must be mailed, place the drive in a bubble-pack mailer or other suitable protective packaging and label the package "FRAGILE."

Avoid exposing a drive to magnetic fields. Security devices with magnetic fields include airport walk-through devices and security wands. The airport security devices that check carry-on luggage, such as conveyor belts, use X-rays instead of magnetism and will not damage a drive.

---

## Using external drives

Removable external drives expand your options for storing and accessing information.

USB drives include the following types:

- 1.44-megabyte diskette drive
- Hard drive module (a hard drive with an adapter attached)
- DVD-ROM Drive
- DVD/CD-RW Combo Drive
- DVD+RW/R and CD-RW Combo Drive
- DVD±RW/R and CD-RW Combo Drive

## Using optional external devices

---

 **NOTE:** For more information about required software and drivers, or to learn which device port to use, refer to the manufacturer's instructions.

---

To connect an external device:

---

 **CAUTION:** To reduce the risk of damage to the equipment when connecting a powered device, be sure that the device is turned off and the AC power cord is unplugged.

---

1. Connect the device.
2. If you are connecting a powered device, plug the device power cord into a grounded AC outlet.
3. Turn on the device.

To disconnect an unpowered external device, turn off the device, and then disconnect it. To disconnect a powered external device, turn off the device, disconnect it, and then unplug the AC power cord.

---

# 10 Memory modules

The device has one memory module compartment, which is located on the bottom of the device. The memory capacity of the device can be upgraded by replacing the existing memory module in the primary memory module slot.

- △ **WARNING!** To reduce the risk of electric shock and damage to the equipment, unplug the power cord and remove all batteries before installing a memory module.
- △ **CAUTION:** Electrostatic discharge (ESD) can damage electronic components. Before beginning any procedure, ensure that you are discharged of static electricity by touching a grounded metal object.

To add or replace a memory module:

1. Save your work.
2. Shut down the device and close the display.

If you are not sure whether the device is off or in Hibernation, turn the device on by sliding the power switch. Then shut down the device through the operating system.

3. Disconnect all external devices connected to the device.
4. Unplug the power cord from the AC outlet.
5. Turn the device upside down on a flat surface.
6. Remove the battery from the device.
7. Using a small Phillips screwdriver, loosen the 2 cover screws **(1)**.

8. Lift the memory module compartment cover (2) away from the device.

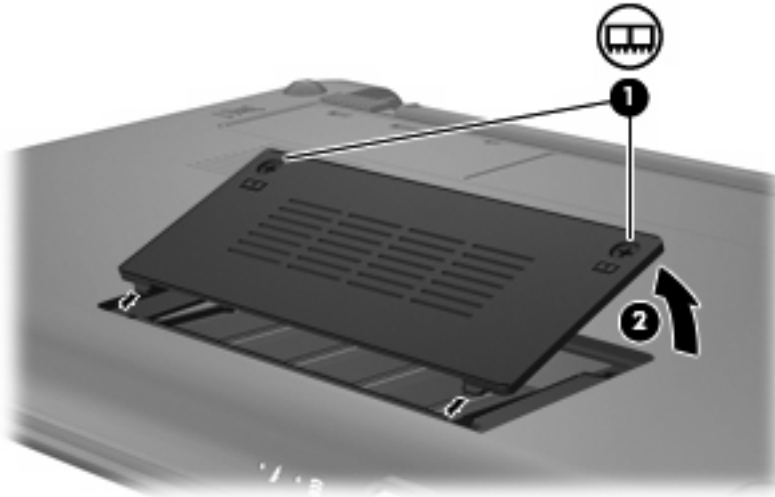

9. Remove the existing memory module:

- a. Pull away the retention clips (1) on each side of the memory module.  
The memory module tilts up.

△ **CAUTION:** To prevent damage to the memory module, hold the memory module by the edges only. Do not touch the components on the memory module.

- b. Grasp the edge of the memory module (2), and gently pull the module out of the memory module slot.

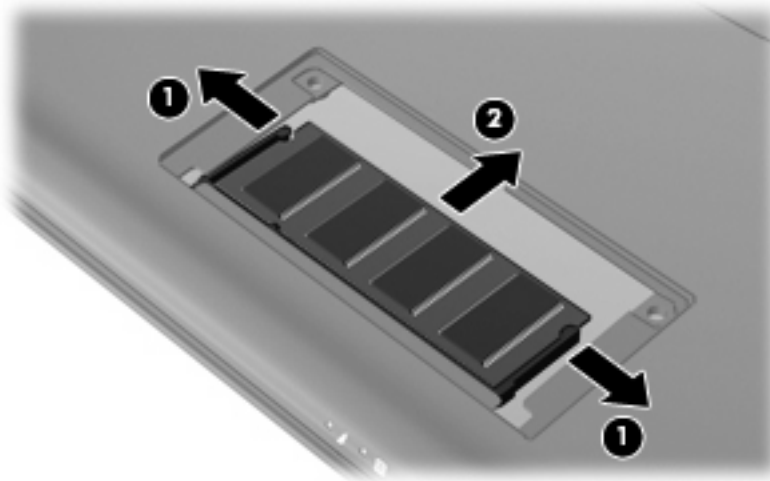

To protect a memory module after removal, place it in an electrostatic-safe container.

10. Insert a new memory module:

△ **CAUTION:** To prevent damage to the memory module, hold the memory module by the edges only. Do not touch the components on the memory module, and do not bend the memory module.

- a. Align the notched edge (1) of the memory module with the tab in the memory module slot.
- b. With the memory module at a 45-degree angle from the surface of the memory module compartment, press the module (2) into the memory module slot until it is seated.
- c. Gently press the memory module (3) down, applying pressure to both the left and right edges of the memory module, until the retention clips snap into place.

△ **CAUTION:** To prevent damage to the memory module, be sure that you do not bend the memory module.

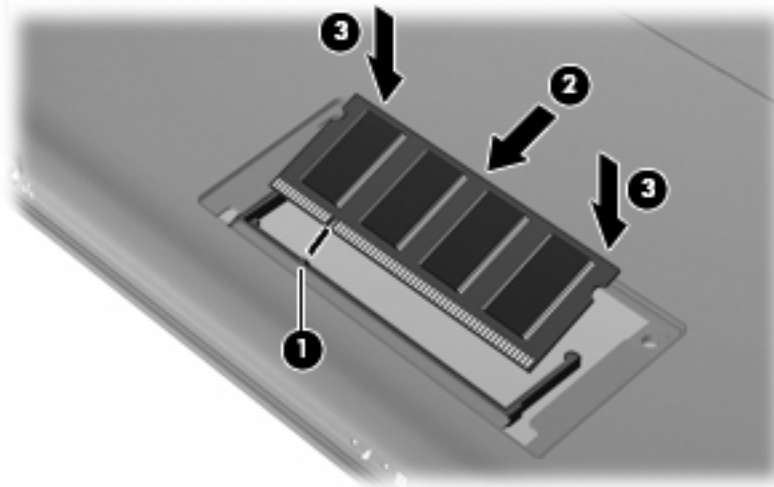

11. Align the tabs on the memory module compartment cover with the notches on the device, and then close the cover (1).
12. Tighten the 2 cover screws (2).

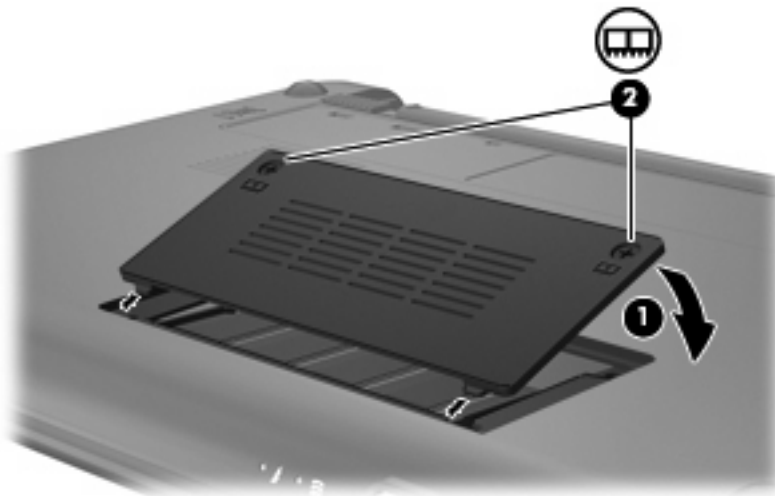

13. Replace the battery.

14. Turn the device right-side up, and then reconnect external power and external devices.
15. Turn on the device.

---

# 11 Updating software

Updated versions of the software provided with your device may be available on the HP Web site.

Most software and BIOS updates on the HP Web site are packaged in compressed files called *SoftPaqs*.

Some download packages contain a file named Readme.txt, which contains information regarding installing and troubleshooting the file.

To update the software, follow these steps, which are explained in the remainder of this guide:

1. Identify your device model, product category, and series or family. Prepare for a system BIOS update by identifying the BIOS version currently installed on the device.

If your device is connected to a network, consult the network administrator before installing any software updates, especially system BIOS updates.

---

 **NOTE:** The device system BIOS is stored on the system ROM. The BIOS initializes the operating system, determines how the device will interact with the hardware devices, and provides for data transfer among hardware devices, including the time and date.

---

2. Access the updates on the HP Web site at <http://www.hp.com>.
3. Install the updates.



# Updating the BIOS

To update the BIOS, first determine what BIOS version you currently have and then download and install the new BIOS.

## Determining the BIOS version

To determine whether available BIOS updates contain later BIOS versions than those currently installed on the device, you need to know the version of the system BIOS currently installed.

BIOS version information (also known as *ROM date* and *System BIOS*) can be displayed by opening the Setup Utility.

To display the BIOS information:

1. Open the Setup Utility by turning on or restarting the device, and then pressing **f10** while the “F10 = BIOS Setup Options” message is displayed in the lower-left corner of the screen.
2. If the Setup Utility does not open with the system information displayed, use the arrow keys to select the **Main** menu.

When the Main menu is selected, BIOS and other system information is displayed.

3. To exit the Setup Utility, use the arrow keys to select **Exit > Exit Discarding Changes**, and then press **enter**.

## Downloading a BIOS update

- △ **CAUTION:** To prevent damage to the device or an unsuccessful installation, download and install a BIOS update only when the device is connected to reliable external power using the AC adapter. Do not download or install a BIOS update while the device is running on battery power, docked in an optional docking device, or connected to an optional power source. During the download and installation, follow these instructions:

Do not disconnect power from the device by unplugging the power cord from the AC outlet.

Do not shut down the device or initiate Standby or Hibernation.

Do not insert, remove, connect, or disconnect any device, cable, or cord.

To download a BIOS update:

1. Access the page on the HP Web site that provides software for your device:  
Select **Start > Help and Support**, and then select the software and drivers update.
2. Follow the instructions on the screen to identify your device and access the BIOS update you want to download.
3. At the download area, follow these steps:
  - a. Identify the BIOS update that is later than the BIOS version currently installed on your device. Make a note of the date, name, or other identifier. You may need this information to locate the update later, after it has been downloaded to your hard drive.
  - b. Follow the instructions on the screen to download your selection to the hard drive.

Make a note of the path to the location on your hard drive where the BIOS update will be downloaded. You will need to access this path when you are ready to install the update.

---

 **NOTE:** If you connect your device to a network, consult the network administrator before installing any software updates, especially system BIOS updates.

---

BIOS installation procedures vary. Follow any instructions that are displayed on the screen after the download is complete. If no instructions are displayed, follow these steps:

1. Open Windows Explorer by selecting **Start > My Computer**.
2. Double-click your hard drive designation. The hard drive designation is typically Local Disk (C:).
3. Using the hard drive path you recorded earlier, open the folder on your hard drive that contains the update.
4. Double-click the file that has an .exe extension (for example, *filename.exe*).

The BIOS installation begins.

5. Complete the installation by following the instructions on the screen.

---

 **NOTE:** After a message on the screen reports a successful installation, you can delete the downloaded file from your hard drive.

---

# Updating programs and drivers

To download and install software other than a BIOS update, follow these steps:

1. Access the page on the HP Web site that provides software for your device:  
Select **Start > Help and Support**, and then select the software and drivers update.
2. Follow the instructions on the screen to find the software you want to update.
3. At the download area, select the software you want to download and follow the instructions on the screen.

---

 **NOTE:** Make a note of the path to the location on your hard drive where the software will be downloaded. You will need to access this path when you are ready to install the software.

---

4. When the download is complete, open Windows Explorer by selecting **Start > My Computer**.
5. Double-click your hard drive designation. The hard drive designation is typically Local Disk (C:).
6. Using the hard drive path you recorded earlier, open the folder on your hard drive that contains the update.
7. Double-click the file that has an .exe extension (for example, *filename.exe*).  
The installation begins.
8. Complete the installation by following the instructions on the screen.

---

 **NOTE:** After a message on the screen reports a successful installation, you can delete the downloaded file from your hard drive.

---

---

# 12 Setup Utility

## Starting the Setup Utility

The Setup Utility is a ROM-based information and customization utility that can be used even when your Windows operating system is not working.

The utility reports information about the device and provides settings for startup, security, and other preferences.

To start the Setup Utility:

- ▲ Open the Setup Utility by turning on or restarting the device, and then pressing **f10** while the “F10 = BIOS Setup Options” message is displayed in the lower-left corner of the screen.

## Using the Setup Utility

### Changing the language of the Setup Utility

The following procedure explains how to change the language of the Setup Utility. If the Setup Utility is not already running, begin at step 1. If the Setup Utility is already running, begin at step 2.

1. Open the Setup Utility by turning on or restarting the device, and then pressing **f10** while the “F10 = BIOS Setup Options” message is displayed in the lower-left corner of the screen.
2. Use the arrow keys to select **System Configuration > Language**, and then press **enter**.
3. Use the arrow keys to select a language, and then press **enter**.
4. When a confirmation prompt with your language selected is displayed, press **enter**.
5. To save your change and exit the Setup Utility, use the arrow keys to select **Exit > Exit Saving Changes**, and then press **enter**.

Your change goes into effect immediately.

### Navigating and selecting in the Setup Utility

Because the Setup Utility is not Windows based, it does not support the TouchPad. Navigation and selection are by keystroke.

- To choose a menu or a menu item, use the arrow keys.
- To choose an item in a list or to toggle a field, for example an Enable/Disable field, use either the arrow keys or **f5** or **f6**.

- To select an item, press [enter](#).
- To close a text box or return to the menu display, press [esc](#).
- To display additional navigation and selection information while the Setup Utility is open, press [f1](#).

## Displaying system information

The following procedure explains how to display system information in the Setup Utility. If the Setup Utility is not open, begin at step 1. If the Setup Utility is open, begin at step 2.

1. Open the Setup Utility by turning on or restarting the device, and then pressing [f10](#) while the “F10 = BIOS Setup Options” message is displayed in the lower-left corner of the screen.
2. Select the **Main** menu. System information such as the system time and date, and identification information about the device is displayed.
3. To exit the Setup Utility without changing any settings, use the arrow keys to select **Exit > Exit Discarding Changes**, and then press [enter](#).

## Restoring default settings in the Setup Utility

The following procedure explains how to restore the Setup Utility default settings. If the Setup Utility is not already running, begin at step 1. If the Setup Utility is already running, begin at step 2.

1. Open the Setup Utility by turning on or restarting the device, and then pressing [f10](#) while the “F10 = BIOS Setup Options” message is displayed in the lower-left corner of the screen.
2. Use the arrow keys to select **Exit > Load Setup Defaults**, and then press [enter](#).
3. When the Setup Confirmation is displayed, press [enter](#).
4. To save your change and exit the Setup Utility, use the arrow keys to select **Exit > Exit Saving Changes**, and then press [enter](#).

The Setup Utility default settings go into effect when the device restarts.

 **NOTE:** Your password, security, and language settings are not changed when you restore the factory default settings.

## Exiting the Setup Utility

You can exit the Setup Utility with or without saving changes.

- To exit the Setup Utility and save your changes from the current session:
 

If the Setup Utility menus are not visible, press [esc](#) to return to the menu display. Then use the arrow keys to select **Exit > Exit Saving Changes**, and then press [enter](#).
- To exit the Setup Utility without saving your changes from the current session:
 

If the Setup Utility menus are not visible, press [esc](#) to return to the menu display. Then use the arrow keys to select **Exit > Exit Discarding Changes**, and then press [enter](#).

After either choice, the device restarts in Windows.

# Setup Utility menus

The menu tables in this section provide an overview of Setup Utility options.

 **NOTE:** Some of the Setup Utility menu items listed in this chapter may not be supported by your device.

## Main menu

Select	To do this
System information	<ul style="list-style-type: none"><li>• View and change the system time and date.</li><li>• View identification information about the device.</li><li>• View specification information about the processor, memory size, and system BIOS.</li></ul>

## Security menu

Select	To do this
Administrator password	Enter, change, or delete an administrator password.
Power-On Password	Enter, change, or delete a power-on password.

## System Configuration menu

Select	To do this
Language Support	Change the Setup Utility language.
Processor C4 State	Enable/disable the processor C4 sleep state.
Boot Options	<p>Set the following boot options:</p> <ul style="list-style-type: none"><li>• <b>f10</b> and <b>f12</b> Delay (sec.)—Set the delay for the <b>f10</b> and <b>f12</b> functions of the Setup Utility in intervals of 5 seconds each (0, 5, 10, 15, 20).</li><li>• Internal Network Adapter boot—Enable/disable boot from Internal Network Adapter.</li><li>• Boot Order—Set the boot order for:<ul style="list-style-type: none"><li>◦ Internal hard drive (select models only)</li><li>◦ USB Floppy</li><li>◦ USB CD/DVD ROM Drive</li><li>◦ USB flash drive</li><li>◦ USB Hard drive</li><li>◦ USB Card Reader</li><li>◦ Network adapter</li></ul></li></ul> <p><b>NOTE:</b> Only the devices attached to the system will appear in the boot order menu.</p>

## Diagnostics menu

Select	To do this
Hard Disk Self Test (select models only)	Run a comprehensive self-test on the hard drive.
Memory Test	Run a diagnostic test on the system memory.

---

# Index

- A**
  - AC adapter
    - connecting 14
    - identifying 9
  - administrator password
    - creating 45
    - entering 45
    - managing 45
  - airport security devices 58
  - antennas 8
  - applications key, Windows 3
  - audio devices, connecting
    - external 39
  - audio functions, checking 39
  - audio-in (microphone) jack 6, 36
  - audio-out (headphone) jack 6, 36
- B**
  - battery
    - calibrating 19
    - charging 16, 19
    - conserving power 21
    - discharging 17
    - disposing 22
    - identifying 9
    - inserting 15
    - low battery levels 17
    - recharging 21
    - removing 15
    - storing 21
  - battery bay, identifying 7
  - battery light 4, 16, 17
  - battery power 14
  - battery release latches 7, 15
  - battery temperature 21
  - bay, battery 7
  - BIOS, updating 65
  - boot options 70
  - boot order 70
  - button, volume mute 37
  - buttons
    - left TouchPad 1
    - right TouchPad 2
- C**
  - cables
    - LAN 24
    - USB 52
    - VGA 41
  - calibrating battery 19
  - caps lock light, identifying 2
  - CD drive 59
  - changing the Setup Utility
    - language 68
  - charging batteries 16, 19
  - checking audio functions 39
  - compartments, memory
    - module 8
  - components
    - additional hardware 9
    - bottom 7
    - display 6
    - front 3
    - left-side 5
    - right-side 5
    - TouchPad 1
  - connecting to a WLAN 29
  - connection, external power 14
  - conservation, power 21
  - cord, power 9
  - corporate WLAN connection 29
  - critical battery level 18
- D**
  - Diagnostics menu 71
  - digital card
    - inserting 50
    - removing 51
    - stopping 51
  - Digital Media Slot, identifying 5
  - diskette drive 59
  - display
    - image, switching 56
    - screen brightness hotkeys 56
  - display switch, identifying 7
  - displaying system information 69
  - drive light, identifying 4
  - drive media 11
  - drives
    - diskette 59
    - external 59
    - hard 59
    - optical 59
  - drives, boot order 70
  - DVD drive 59
- E**
  - earbuds 6, 36
  - encryption 29
  - entering a power-on
    - password 46
  - entering an administrator
    - password 45
  - exiting the Setup Utility 69
  - external audio devices,
    - connecting 39
  - external drive 59
  - external monitor port 41
  - external monitor port,
    - identifying 5
- F**
  - firewall 29
  - fn key 3, 54
  - function keys 3, 54
- H**
  - hard disk drive, external 59
  - hard drive self test 71



- hard drive, external 59
- hardware, identifying 1
- headphone (audio-out) jack 6, 36
- headphones 6, 36
- Hibernation
  - exiting 12
  - initiated during critical battery level 18
  - initiating 12
- hotkeys
  - decreasing screen brightness 56
  - decreasing speaker sound 57
  - description 54
  - increasing screen brightness 56
  - increasing speaker volume 57
  - initiating QuickLock 56
  - initiating Standby 55
  - muting speaker sound 57
  - switching screen image 56
  - using 55
- HP Mobile Broadband Module 31
- HP Mobile Broadband, disabled 31
- hubs 52

## I

- icons
  - network status 25
  - wireless 25
- internal display switch, identifying 7
- internal microphone, identifying 7, 36
- Internet connection setup 28

## J

- jacks
  - audio-in (microphone) 6, 36
  - audio-out (headphone) 6, 36
  - RJ-45 (network) 5

## K

- keyboard hotkeys, identifying 54
- keys
  - fn 3
  - function 3
  - Windows applications 3
  - Windows logo 3

## L

- labels
  - Microsoft Certificate of Authenticity 10
  - regulatory 10
  - service tag 9
- language support 70
- latches, battery release 7
- left TouchPad button, identifying 1
- lights
  - battery 4
  - caps lock 2
  - drive 4
  - power 4
  - webcam 7
  - wireless 4
- local area network (LAN)
  - cable required 24
  - connecting cable 24
- low battery level 17

## M

- Main menu 70
- managing a power-on password 46
- managing an administrator password 45
- memory module
  - inserting 61
  - removing 61
- memory module compartment
  - cover
    - removing 61
    - replacing 62
- memory module compartment, identifying 8
- memory test 71
- microphone (audio-in) jack 6, 36
- monitor, connecting 41
- mouse, external
  - connecting 54
  - setting preferences 54
- multimedia components, identifying 35
- multimedia software
  - installing 38
  - using 38
- mute button 37
- mute hotkey, identifying 36

## N

- navigating in the Setup Utility 68
- network cable
  - connecting 24
  - noise suppression circuitry 24
- network jack, identifying 5
- network status icon 25
- noise suppression circuitry, network cable 24

## O

- operating system 22
- optical drive 59

## P

- passwords
  - administrator 45
  - power-on 45
  - set in Setup Utility 44
  - set in Windows 44
- ports
  - external monitor 41
  - USB 5, 6, 52
- power
  - connecting 14
  - conserving 21
- power connector, identifying 6
- power cord, identifying 9
- power light, identifying 4
- power switch, identifying 4
- power-on password
  - creating 46
  - entering 46
  - managing 46
- Processor C4 State 70
- product name and number, device 9
- programs, updating 67
- projector, connecting 41
- public WLAN connection 29

## Q

- QuickLock 44
- QuickLock hotkey 56

## R

- readable media 11
- regulatory information
  - HP Mobile Broadband Module serial number 10

- regulatory label 10
    - wireless 10
  - release latches
    - battery 7, 16
  - restoring default settings 69
  - right TouchPad button,
    - identifying 2
  - RJ-45 (network) jack,
    - identifying 5
- S**
- screen brightness hotkeys 56
  - screen image, switching 56
  - security cable slot, identifying 5
  - Security menu 70
  - security, cable slot 5
  - security, wireless 28
  - selecting in the Setup Utility 68
  - serial number, device 9
  - service tag 9
  - setup of WLAN 28
  - Setup Utility, passwords set in 44
  - setup, device 1
  - shut down 22
  - SIM
    - inserting 31
    - removing 32
  - software
    - installing 38
    - multimedia 38
    - Windows Media Player 38
  - speakers, identifying 6, 36
  - Standby
    - exiting 11
    - initiating 11
  - Standby hotkey 55
  - storing battery 21
  - switches
    - power 4
    - wireless 4
  - System Configuration menu 70
  - system information 70
- T**
- temperature 21
  - TouchPad
    - buttons 1
    - identifying 1
    - using 54
  - TouchPad scroll zone,
    - identifying 1
  - traveling with the device 21
  - turning off the device 22
- U**
- unresponsive system 22
  - USB cable, connecting 52
  - USB devices
    - connecting 52
    - description 52
    - removing 53
    - stopping 53
  - USB hubs 52
  - USB ports, identifying 5, 6, 52
- V**
- vents, identifying 6, 8
  - video transmission types 56
  - volume down hotkey,
    - identifying 36
  - volume mute button 37
  - volume up hotkey, identifying 36
  - volume, adjusting 37
- W**
- webcam light, identifying 7, 36
  - webcam, identifying 7, 36
  - Windows applications key,
    - identifying 3
  - Windows logo key, identifying 3
  - Windows, passwords set in 44
  - wireless antennas 8
  - wireless controls
    - button 26
    - operating system 26
  - wireless icon 25
  - wireless light, identifying 4, 26
  - wireless network (WLAN)
    - connecting 29
    - corporate WLAN
      - connection 29
    - equipment needed 28
    - functional range 30
    - public WLAN connection 29
    - security 28
  - wireless network, connecting 25
  - wireless switch, identifying 4, 26
  - WLAN antennas, identifying 8
  - WLAN device 25
  - writable media 11
  - WWAN antennas, identifying 8

