

Aastra 7444ip

IP Phone for MX-ONE™

USER GUIDE



AASTRA

Copyright

© Copyright Aastra Technologies Limited, 2010. All rights reserved.

No parts of this publication may be reproduced, stored in retrieval systems, or transmitted in any form or by any means, electronic, mechanical, photocopying, recording or otherwise, without prior written permission of the publisher except in accordance with the following terms.

If this publication is made available on Aastra media, Aastra gives its consent to downloading and printing copies of the content provided in this file only for private use and not for redistribution. No parts of this publication may be subject to alteration, modification or commercial use. Aastra will not be liable for any damages arising from use of an illegal modified or altered publication.

1 Introduction

TRADEMARK

Aastra is a registered trademark of Aastra Technologies Limited. All other trademarks herein are the property of their respective owners.

DISCLAIMER

While every effort has been made to ensure accuracy, Aastra will not be liable for technical or editorial errors or omissions contained within this documentation. The information contained in this documentation is subject to change without notice.

1.1 About this User Guide

This user guide describes the available features of the Aastra 7444ip phone (also known as DBC 444) when it is connected to MX-ONE.

The user guide is valid for MX-ONE Telephony System – Telephony Switch and Telephony Server. Whenever only one system is applicable, this is specifically stated in the document.

All the procedures, suffix digits, tone messages and times used in this document are according to the standard application system.

Note: All names and numbers presented in the displays in this user guide are examples.

Not all exchanges are equipped with all features. By using service profiles, it is possible to vary the number of features assigned to each individual extension. This can affect the display information. The person or department responsible for telecommunications in your organization, will inform you of which features have been assigned to you.

2 Safety Instructions

Read this chapter before using the telephone.

For safe and efficient operation of the telephone, observe the guidelines given in this manual and all necessary safety precautions when using the telephone. Follow the operating instructions and adhere to all warnings and safety precautions located on the product, the Quick Reference Guide and this User Guide.

2.1 Approved Adapters

To ensure problem free operation, only use the adapters listed in the sections below.

2.1.1 Recommended Plug-in Adapters

The telephone can be powered either from the network or from a 5 V AC/DC plug-in power adapter. Only use the plug-in adapter (power supply) listed below, or an adapter approved by your local retailer.

- RES 141 319/1 for the EU market except for the UK
- RES 141 319/2 for the US market
- RES 141 319/3 for the UK market

Note: For other markets the power adapter can be locally sourced.

For information about installing the power adapter, see 4.1 Cabling on page 22.

2.1.2 Required Headset Adapter

The headset port on the phone is intended primarily for wireless headsets that require an 8-pole connector (see 6.2 Headset on page 40).

If you are using a standard 4-pole headset, an adapter is required. Only use the following headset adapter.

- TSR217001/1

For information about installing the power adapter, see 4.1 Cabling on page 22.

2.2 Precautions

Note: When using your telephone or connected equipment, the following basic safety precautions should always be followed to reduce risk of fire, electrical shock and other personal injury.

- **Save this manual.** It includes important safety information and operating instructions. Save all instructions for future reference.
- **Note:** Do not use the telephone in areas with a danger of explosion, as it is not specified as intrinsically safe.
- Always install equipment in a location and environment for which it is designed.
- For mains powered telephones: Only operate with the mains power voltage indicated. If you are uncertain of the type of power supplied to the building, consult property management or your local power company.
- For mains powered telephones: Avoid placing the telephone power cable where it can be exposed to mechanical pressure as this may damage the cable. If the power supply cord or plug is damaged, disconnect the product and contact qualified service personnel.
- Be careful not to keep credit cards near the phone, since they may be demagnetized due to the strong magnets in the phone.
- The handset's earcap region is slightly magnetic and may pick up small metallic objects, such as 26/6 gauge staples. Check the earcap region for metallic objects before use.
- Headsets used with this equipment must comply with EN/IEC 60950-1 and for Australia AS/NZS 60950.1-2003.
- Do not make any changes or modifications to equipment without seeking approval from the party responsible for compliance. Unauthorized changes or modifications could void the user authority to operate the equipment.
- Do not spill liquid of any kind on the product or use the equipment near water, for example, near a bathtub, washbowl, and kitchen sink, in a wet basement or near a swimming pool.
- Clean the phone with a cloth slightly moistened with a mild soap solution.
- Do not insert any object into equipment slots that is not part of the product or auxiliary product.
- Do not disassemble the product. Contact a qualified service agency when service or repair work is required.

- Avoid using a telephone (other than a cordless type) during an electrical storm. There may be a remote risk of electric shock from lightning.
- Do not use the telephone to report a gas leak in the vicinity of the leak.
- Use only the power cord indicated in this manual.
- Only use the telephone in temperatures between 0° C to +40° C (32° F to 104° F).
- Avoid exposing the telephone for direct sunlight or close to other heat sources.
- Do not expose the telephone to open flame.
- Keep the telephone away from excessive heat and moisture.
- Moving the equipment rapidly between warm and cold temperatures may cause condensation (water droplets) to form on its internal and external surfaces. Water droplets may cause malfunction of the equipment and corrupt or end communication or damage the equipment. When condensation is noticed, stop using the equipment. Switch off the phone, remove the battery and unplug the mains adapter from the power outlet. Wait until the moisture evaporates from the equipment before putting it in operation again.
- Protect your telephone from aggressive liquids and vapours.
- If the liquid crystal display breaks, avoid injury by preventing the liquid crystal from coming into contact with eyes, skin or mouth. Prevent the liquid crystal from leaking out of the broken glass.
- In case of smoke or fumes, stop operating the product and turn it off immediately. Unplug the mains adapter immediately. Continued operation may result in fire or electrical shock.

2.2.1

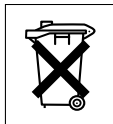

Disposal of the Product

Defective phone equipment should not be placed in municipal waste. Please check local regulations for disposal of electronic products.

2.3 Regulatory Compliance Statements (EU and EFTA only)

Hereby, Aastra Telecom Sweden AB, Box 42214, SE-126 17 Stockholm, declares that this product(s) is in conformity with the essential requirements and other relevant provisions of the European Directive 1999/5/EC (R&TTE Directive).



Details to be found at www.aastra.com/sdoc

2.4 Regulatory Compliance Statements (USA and Canada only)

2.4.1 FCC Compliance Statements

This equipment has been tested and found to comply with the limits for a Class B digital device, pursuant to Part 15 of the FCC rules.

These limits are designed to provide reasonable protection against harmful interference in a residential installation. This equipment generates, uses and can radiate radio frequency energy and, if not installed and used in accordance with the instructions, may cause harmful interference to radio communications.

However, there is no guarantee that interference will not occur in a particular installation. If this equipment does cause harmful interference to radio or television reception, which can be determined by turning the equipment off and on, the user is encouraged to try to correct the interference by one or more of the following measures:

- Reorient or relocate the receiving antenna.
- Increase the separation between the equipment and receiver.
- Connect the equipment into an outlet on a circuit different from that to which the receiver is connected.
- Consult the dealer or an experienced radio/TV technician for help.

The telephone is HAC (Hearing Aid Compatible).

3

Aastra 7444ip Description

This chapter describes the Aastra 7444ip phone and its main features.

The phone has a 3.5 inch, backlit color display with 4 soft keys and 2 navigation keys. It also has 8 programmable shortcut keys, 5 menu keys, 6 function keys, and a standard keypad with 12 alphanumeric keys. The telephone is shown in the figure below.

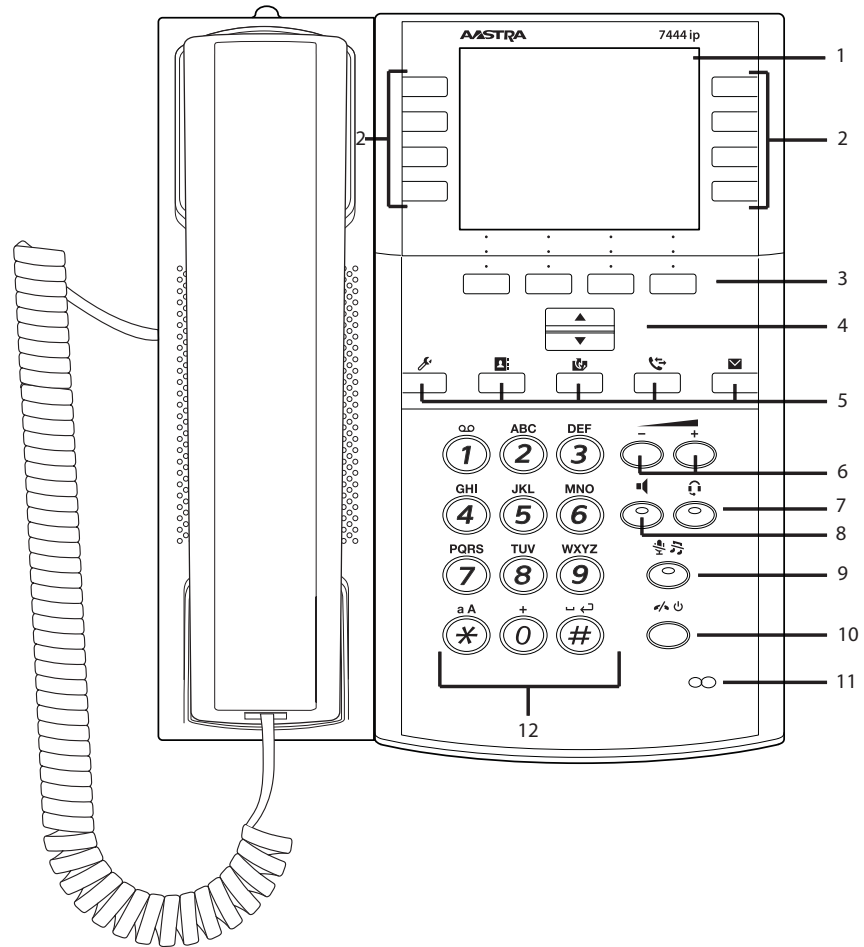

Figure 1: Aastra 7444ip Front View

Pos.	Key or feature	Pos.	Key or feature
1	Display	7	Headset key
2	Shortcut and Line keys	8	Loudspeaker key
3	Soft keys	9	Mute key
4	Navigation keys	10	Clear key/power key
5	Menu keys	11	Microphone
6	Volume keys	12	Keypad

3.1 Functions and Accessories

The Aastra 7444ip main features are listed below, in Table 1 Features, and its accessories are listed in Table 2 Accessories.

Table 1 Features

Intuitive graphical user interface
Downloadable ring melodies
Call list sorted by call type
Corporate directory
80 shortcuts

Table 2 Accessories

Option unit with Gigabit support
Key Panel Unit, Display Panel Unit
Wireless headset support

3.2 Display Information

The icons and text in the display indicate functions and settings available to the user. The display gives visual feedback on all actions performed, and also text information.

In idle mode, the phone display shows your name or extension number, or both, along with time and date information in the top row of the display. The shortcuts of the 1st shortcuts page are displayed, see Figure 2.

Note: If a name is available it is displayed together with, or instead of, the number.

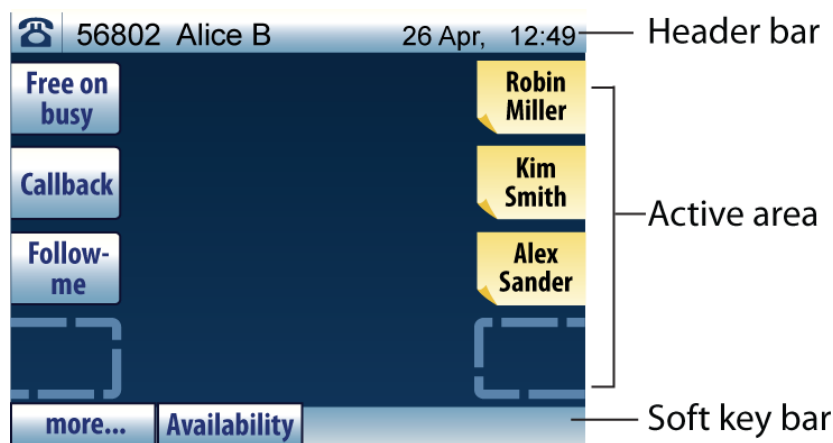















Figure 2: Example of a display in idle mode









- | | |
|---------------------|---|
| Header bar | The top row (Header bar) contains information about the phone status, which menu is active (if any) and who is logged on (if anyone), and displays the current date and time. |
| Active area | The next rows (Active area) displays status text about call diversion or missed calls, as well as information about ongoing calls. This area also contains shortcut keys in two columns of 4 keys each. |
| Soft key bar | The bottom row (Soft key bar) displays soft keys, which vary according to the status and which menu is open. |

3.2.1 Display Icons

The phone display conveys information about call status, presence, and a number of settings. This information is conveyed via messages and icons. The icons are described below.

Table 3 Display Icons





Icon	Description
	<p>Idle mode indicator Appears in the upper left corner of the display to indicate that the phone is in idle mode.</p>
	<p>Volume level Indicates the ring signal volume in idle or ringing mode, or in speech mode, the loudspeaker or earpiece volume.</p>
	<p>Sound off Shown when you press and hold the mute key,  .</p>
	<p>Microphone off Shown when you press and hold the mute key,  , during an ongoing call.</p>
	<p>Headset Indicates that the headset preset mode is activated.</p>
	<p>Voicemail message Displayed when you have new voicemail messages in your inbox.</p>
	<p>Line key When a number/contact is dialed, the shortcut keys in the left column changes to line keys.</p>
	<p>Received call Indicates a received call.</p>
	<p>Dialed call Indicates a dialed call.</p>

Icon (Cont.)	Description (Cont.)
	<p>On hold Indicates that the call is put on hold.</p>
	<p>Diversion Indicates that your extension is diverted.</p>
	<p>Missed calls This icon indicates, together with the text “Missed calls” that you have new missed calls. The number of missed calls are specified next to the icon.</p>
	<p>Free on busy inactivated Indicates that free on busy is not activated. Is displayed during an ongoing call, and during an incoming or outgoing call. Default setting.</p>
	<p>Free on busy activated Indicates that free on busy is activated. Is displayed during an ongoing call, and during an incoming or outgoing call.</p>
	<p>Security Indicates that the ongoing call is secure between the A and B parties. The media (speech) and the signalling are encrypted.</p>
	<p>Lock Indicates that the phone is locked. An authorization code may be required in order to use the phone.</p>
	<p>Access warning Flashes when the access to system services is reduced (some system services do not work).</p>

3.2.2 Menu Keys

The phone menus are reached via 5 individual menu keys, which are described below.

Table 4 Menu Key Icons

Icon	Description
	My Settings Pressing this key opens the My Settings menu, which contains settings such as availability, shortcuts, sounds, time and date. For more information, see 18 Settings on page 106.
	Contacts Pressing this key opens the Contacts list, which contains the personal contacts. It is also possible to download a company phonebook for viewing. For more information, see 12 Contacts on page 74.
	Shortcuts Pressing this key opens the second page of the Shortcuts list (the first page is displayed in idle mode). For more information, see 3.2.4 Shortcut Keys on page 14.
	Call List Pressing this key opens the Call List , which contains detailed information about calls made and received. For more information, see 11 Call List on page 70.
	Messages Pressing this key opens the Messages menu, which contains options for message and voicemail handling. For more information, see 15 Messages on page 90.

3.2.3 Function Keys



The function keys are the volume keys, the loudspeaker key, the headset key, the mute key and the clear / power key, see 1 Aastra 7444ip Front View on page 8.

With the clear / power key  it is possible to power on / off the telephone, see 5.3 Automatic Shut Down of the Phone on page 35 and 5.4 Shutting Down the Phone on page 36.

3.2.4 Shortcut Keys

The shortcuts look different depending on the type of shortcut. They look either like a yellow sticky note, or a blue soft key, see the table below for a detailed description of the shortcut types and their symbols.

For information on how to add, edit and delete shortcuts, see 14 Shortcuts on page 84.

Icon	Description
	Features. Examples: Free on busy, Follow-me, Callback
	Monitoring keys. Shortcuts to monitored extensions. For more information, see 17.11 Monitoring Keys on page 105
	Phone numbers. Internal extensions and external numbers. The shortcuts can be labeled with number or name.
	unassigned shortcut

Note: Some shortcut keys may already be programmed by the system administrator when you receive the phone.

3.2.4.1 Features and Monitoring Keys

Shortcuts to features and monitoring keys (MNS keys) can only be programmed by the system administrator.

For more information on MNS keys, see 17.11 Monitoring Keys on page 105.

3.2.4.2 Phone Numbers

Phone numbers, that is, internal extensions or external numbers, can be programmed as shortcuts by the user or the system administrator. A phone number can include any function codes, see 21 Telephony Suffixes and Service Codes on page 123.

Phone numbers can be programmed as shortcuts from the phone (see 18.2 Shortcuts on page 108), or from the phone's web interface (see 19.1 Using the Phone Through the Web on page 116).

The phone must be logged on to the telephony system to enable shortcut programming.

3.3 Menu Structure

In the sections below, the phone menus are described in brief. For a detailed description of the various menu options, please see the relevant sections in this manual.

Note: Depending on the phone configuration, the menus in your phone may differ from the menu figures below.

When a scroll bar is visible at the right in the display, there are more options than the ones currently shown. You can then use the navigation keys to scroll the list.

3.3.1 Idle Mode

In idle mode, the phone icon  appears to the far left in the top row of the phone display. In the bottom row of the display, soft keys **more...** and **Availability** are visible. The menu structure below shows which features are available when you press either of these soft keys.

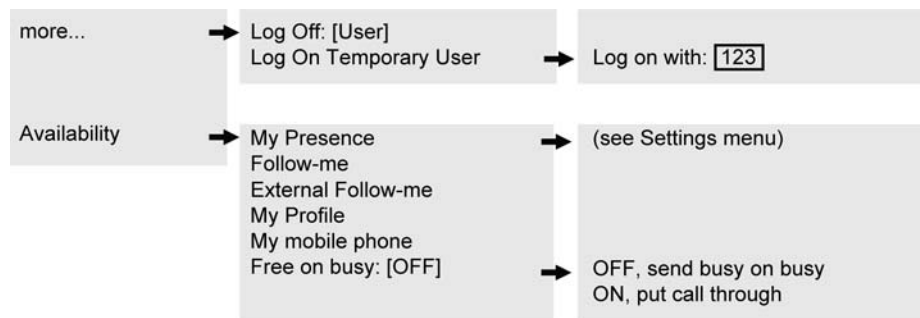

Figure 3: Idle menu structure

3.3.2 Settings Menu

Pressing the  key activates the **My Settings** menu. See figure below for a description of the menu structure.

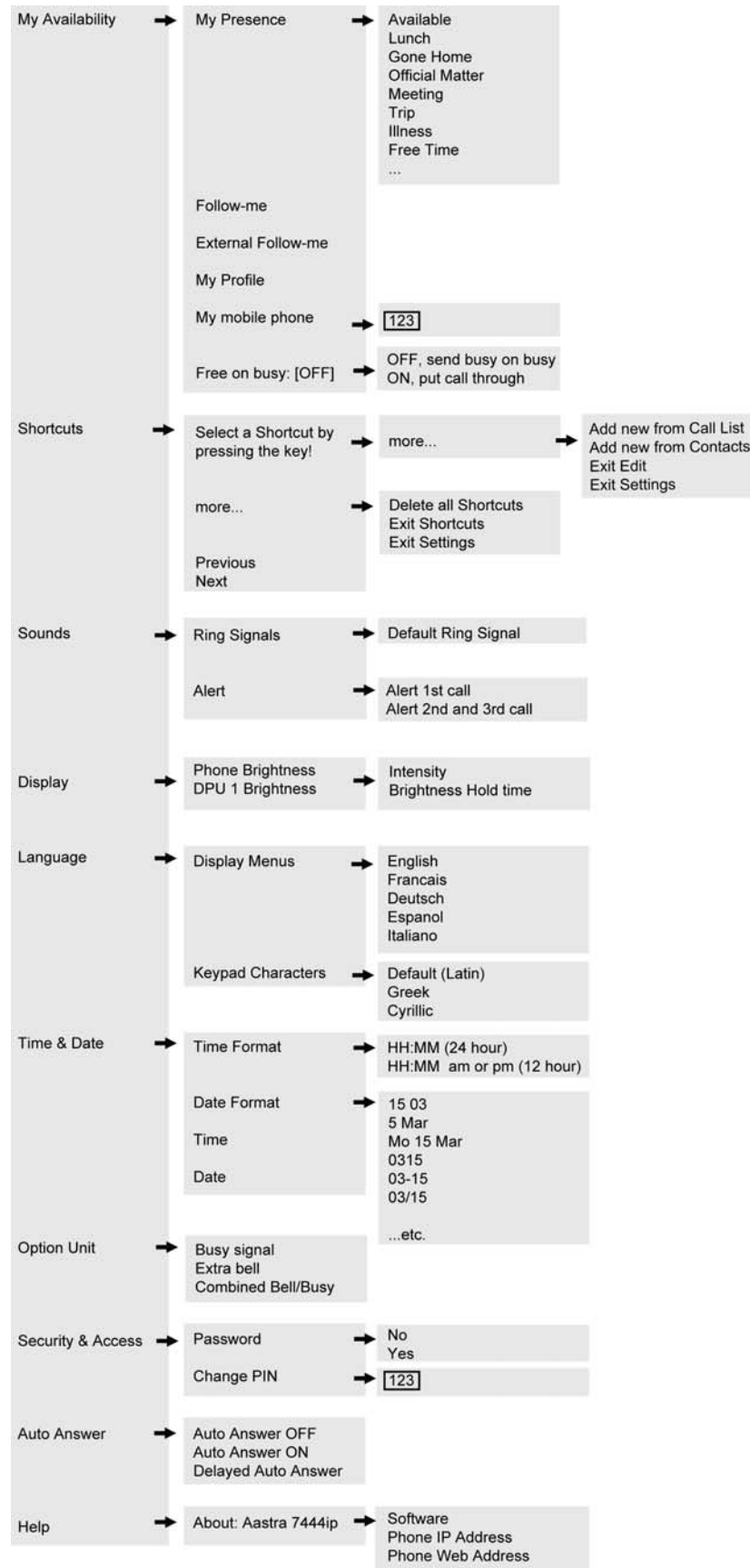



Figure 4: Settings menu structure

3.3.3 Contacts Menu

Pressing the  key activates the **Contacts** menu. See figure below for a description of the menu structure.

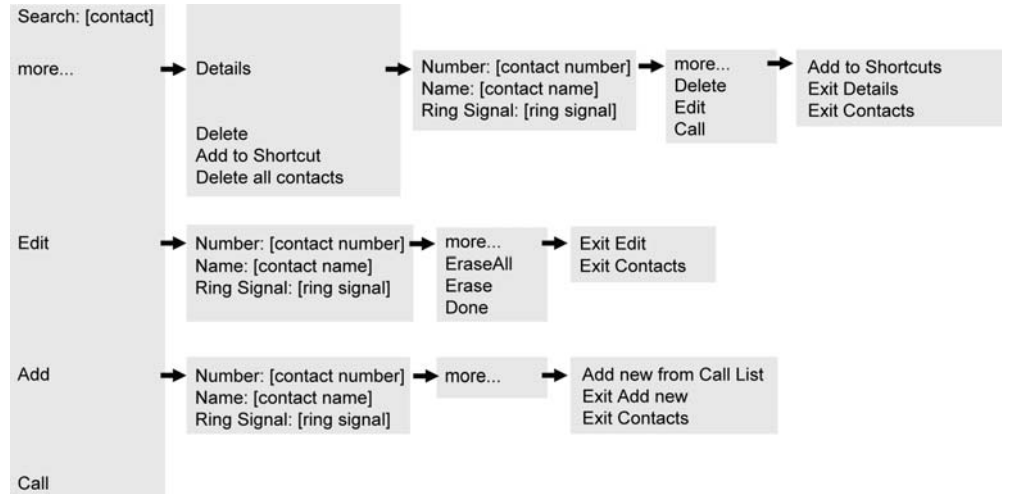



Figure 5: Contacts menu structure

3.3.4 Shortcuts Menu

Pressing the  key opens the 2nd page of the **Shortcuts** menu. See figure below for a description of the menu structure.

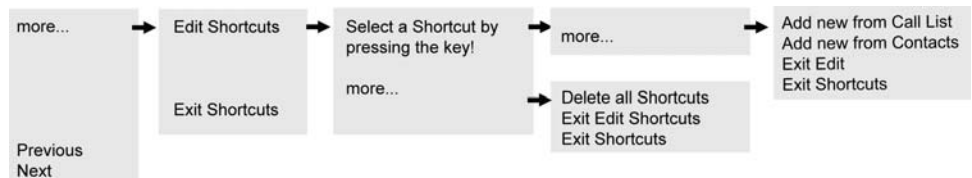

Figure 6: Shortcuts menu structure

3.3.5 Call List Menu

Pressing the  key activates the **Call List** menu. See figure below for a description of the menu structure.



Figure 7: Call list menu structure

3.3.6 Messages Menu

Pressing the  key activates the **Messages** menu. See figure below for a description of the menu structure.

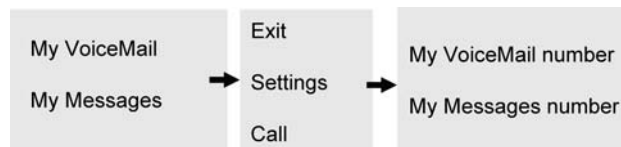

Figure 8: Messages menu structure

3.4 Ring Tones and Signals

You can set different ring signals and melodies in the phone. For more information about settings ring signals and melodies, see 18.3.1 Changing Ring Signals for Incoming Calls on page 108.

Different ring cadences help you distinguish between different call types, so that you know, for example, whether an incoming call is internal or external, or whether it is a callback call. For more information, see 3.4.1 Ring Signals - Incoming Calls on page 19.

To distinguish between different callers, you can assign different ring signals to your contacts. For more information, see 12.3 Edit a Contact on page 76.

3.4.1 Ring Signals - Incoming Calls

There are three different types of incoming calls, each with their own characteristic ring signal. The signals shown below are the three most commonly used signals worldwide. However, many markets have adapted the signals to local standards.

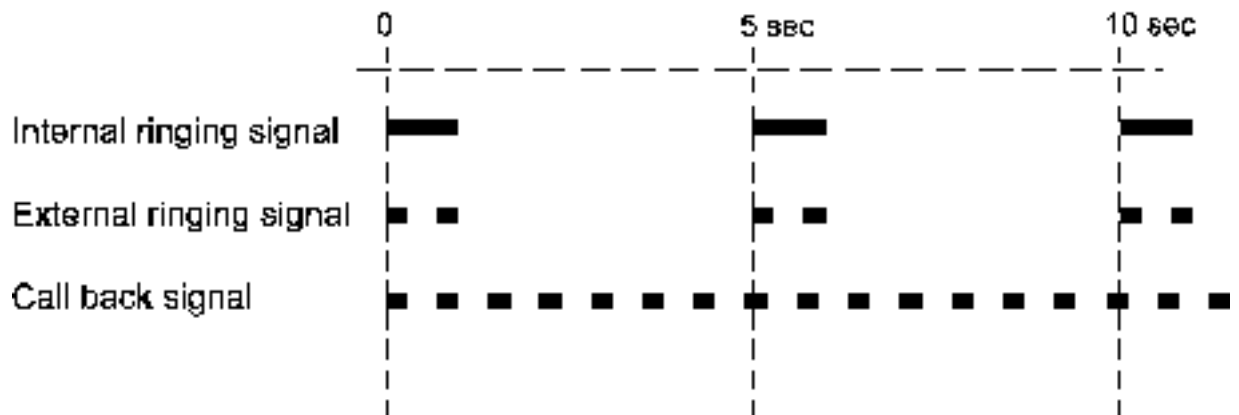



Figure 9: Ring Signals Characteristics

The default alert setting for a second incoming call, is “One Muted”, which means that the phone rings only the first period, with a low level. (The default setting for the first incoming call is “Periodic”.) The alert type can be changed, see 18.3.2 Alert Signal on page 109. This is valid for both the internal and the external ring signal.

3.4.1.1 Ringing Volume

You can adjust the volume of the ring signal by pressing the **Volume** keys. The new volume setting will be saved and remembered also after a power failure.

3.4.1.2 Silent Ringing

If you do not want to be disturbed by the ring signal of incoming calls, but still want to be able to answer an incoming call, you can switch off the ring signal by pressing the mute key, . The LED indicator is lit on the key to indicate silent ringing, and the mute icon, , appears at the bottom of the display. Incoming calls are then indicated only by a flashing line lamp and display information.

Note: The ring signal is switched off temporarily. After you have received an incoming call (by rejecting it or by answering and ending it), the ring signal is switched back on again and the mute icon disappears.

3.4.2 Ring Tones - Outgoing Calls

When you attempt to make a call, you hear different ring tones depending on the line status. The tones described below are the most commonly used tones worldwide. However, many markets have adapted the tones to local standards.

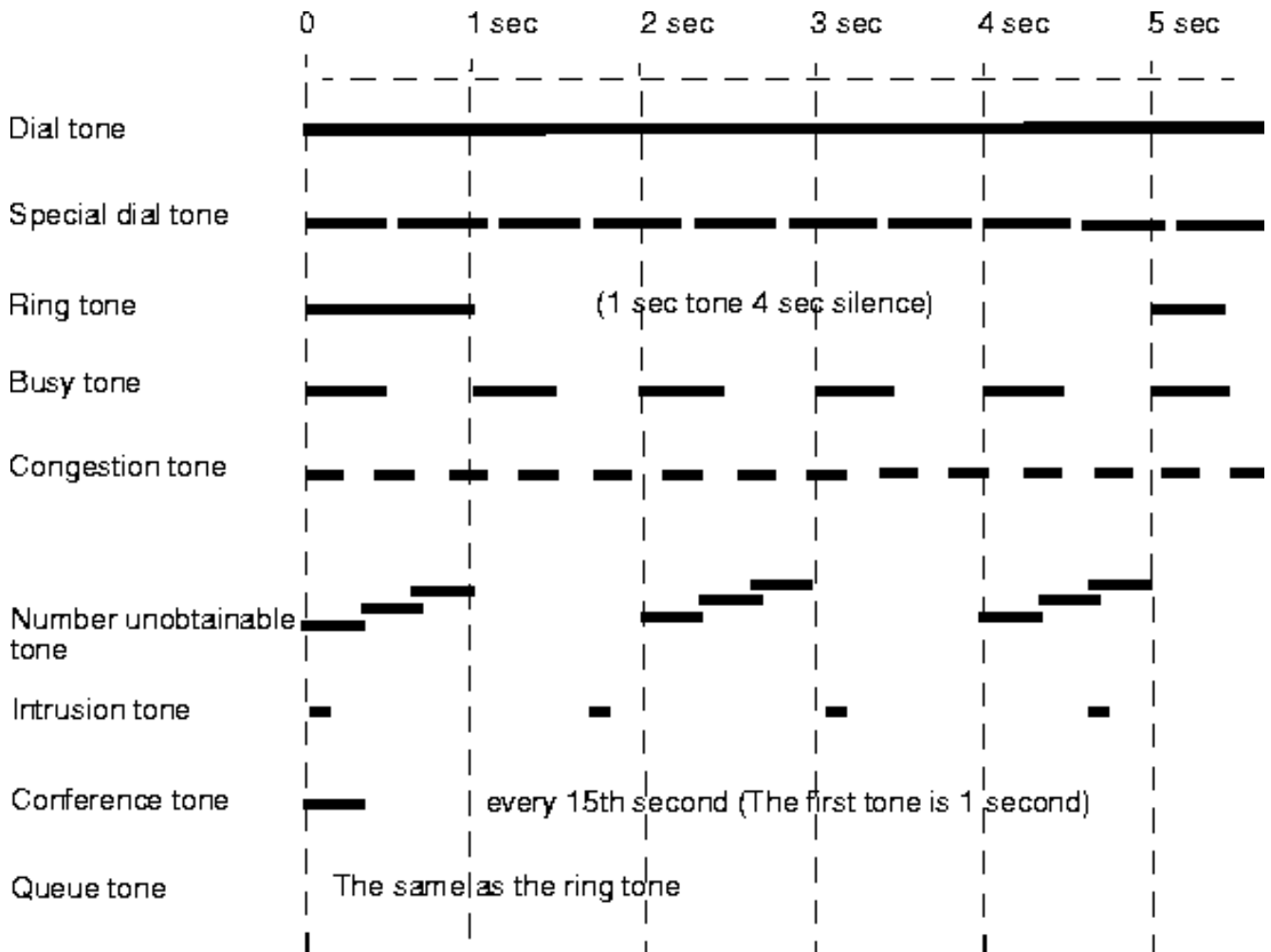

Figure 10: Ring Tones Characteristics

3.5 Status Indicators

Several phone keys have indicator lamps that indicate line status as well as other types of status according to different flash patterns, see description below.

Indicator	Description
Off	Indicates that the feature is inactive.
Steady light	Indicates that the feature is active. When you press a menu key, the key indicator is also lit with a steady light.
Slowly flashing light	Indicates that the line (or feature) is put on hold. A slowly flashing light can also indicate that a shortcut is being programmed.
Rapidly flashing light	Indicates an incoming call. A rapidly flashing light can also indicate an error.
Light with short breaks	Indicates an ongoing call.

4 Installation

This chapter describes how to connect the cables to the phone, and how to install an option unit and a key panel unit and display panel unit.

Note: Also see the illustrated installation cards showing how to install cables, the option and panel units, and how to prepare the phone for mounting.

4.1 Cabling

All connections at the back of the phone are marked for easier identification, see figure below.

Note: For information on which power adapters to use, see 2 Safety Instructions on page 4.

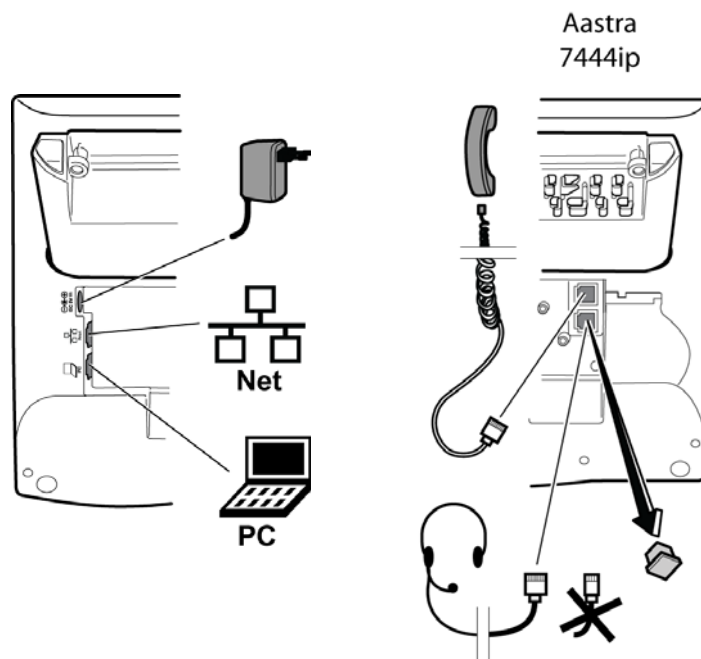

Note 8-pole! RJ45 connector









Figure 11: Aastra 7444ip Back View

Note: The phone's headset port requires a headset cable with an 8-pole connector, see 2.1.2 Required Headset Adapter on page 4.

4.1.1

Cabling Icons

Table 5 Cable Icons

Icon	Description
 DC 5V	<p>Power Inlet</p> <p>The phone is powered by an external AC/DC adapter (see details below) or, alternatively, over a Power over Ethernet (PoE) switch.</p> <ul style="list-style-type: none"> If you use the external power adapter, connect one end of the adapter to the phone connection marked , and the other end to a power outlet. <p>If you use the PoE connection, you only have to connect the phone to the LAN.</p>
	<p>LAN Inlet</p> <p>Connect one end of the Ethernet cable to the phone connection marked Net, and the other end to a LAN connection.</p> <p>Option Unit (Optional)</p> <p>If the phone is equipped with an option unit (DBY 412 02) and connected to a 1 gigabit LAN, the LAN cable must be connected to the port marked Net on the option unit, otherwise it will not work. Make sure also to connect the PC to the PC connector on the option unit.</p>
 PC	<p>PC Inlet</p> <p>Connect one end of the PC cable to the connection marked , and the other cable end to a RJ45 connection on your PC.</p> <p>When the phone is starting up (booting), a connected PC will lose network connection for a few seconds.</p>
	<p>Headset Connector</p> <p>The phone supports wireless headsets. Connect the radio base to the connector marked .</p>
	<p>Handset Connector</p> <p>Connect the handset to the connection marked .</p>

Icon (Cont.)	Description (Cont.)
	<p>Panel Unit (Optional) Connect the Key Panel Unit or the Display Panel Unit to the connector marked Panel.</p>

Note: The phone does not work during power failure, unless powered through a PoE switch.

4.2 Tiltable Display

The phone is equipped with a display that is tiltable, allowing you to change the display angle by pulling its upper part towards you, see figure below.

For information about the display and its layout, see 3.2 Display Information on page 10.



Figure 12: Tiltable display

4.3 Tiltable Foot Console

Your phone is equipped with a foot console that is tiltable, allowing you to adjust the phone angle by tilting the foot console, see figure below.

The foot console is available in two variants. It can be a stand only console, or it can have a built-in option unit. For more information on the option unit, see 4.4 Option Unit (Optional) on page 26.

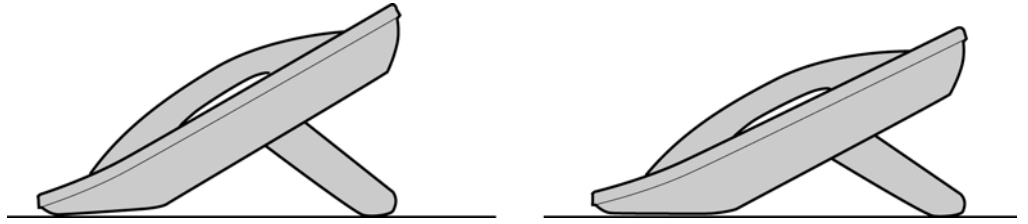
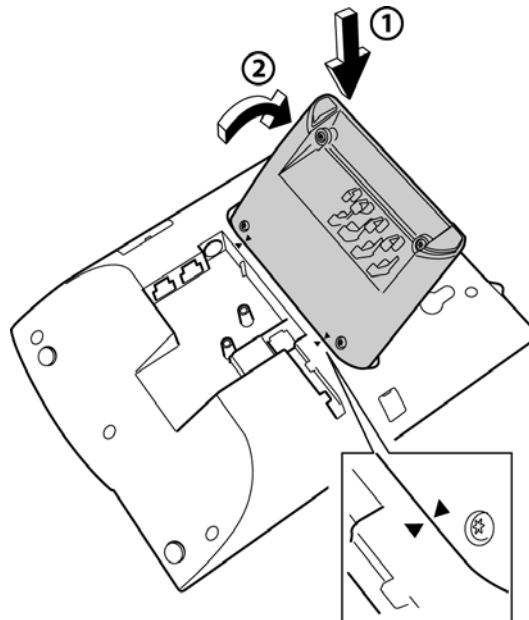

Figure 13: Tilttable Foot Console

4.3.1 Installing the Foot Console

To install the foot console, do the following:

1. Attach the foot at the arrows on the back of the phone.
2. Press until you hear a click sound.



Note: If you wish to remove the foot console, pull the console firmly towards you to release it before removing it from the phone.

3. Connect the cables and attach the Electrostatic Discharge (ESD) cover on the back of the phone to protect the connectors from ESD. For this you need a screwdriver.

For detailed information about the cables, see 4.1 Cabling on page 22.

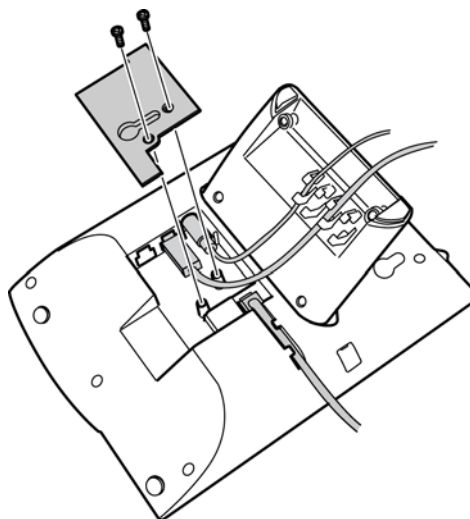

4.4 Option Unit (Optional)

It is possible to install an option unit in the phone. The option unit, which is built into the foot console, provides the phone with Gigabit Ethernet and an extra bell and busy signal.

Gigabit Ethernet

The option unit offers a Gigabit Ethernet interface module, the purpose of which is to pass on gigabit traffic to the PC connected to the IP terminal. The phone itself does not require the gigabit speed.

Extra bell and busy signal

The option unit offers an interface for auxiliary equipment, such as an external bell or a busy signal indicator. There are three alternatives using this function:

- **Busy Signal.** The busy signal is activated in off-hook mode. Can be used to control a Do-not-disturb lamp at the door.
- **Extra Bell.** The extra bell is activated parallel to the ring signal.
- **Combined Bell/Busy.** A combined busy signal and extra bell. Steady active in off-hook mode, and flashing when the phone rings. Can be used for lamp indication in an office landscape, for example.

4.4.1 Installing an Option Unit

To install the option unit, do the following:

1. Log off the phone and disconnect the power from the phone to avoid electrostatic discharges, ESD.
2. Connect the ribbon cable to the phone, making sure the cable does not get stuck.
3. Attach the option unit at the arrows on the back of the phone. Press until you hear a click sound.

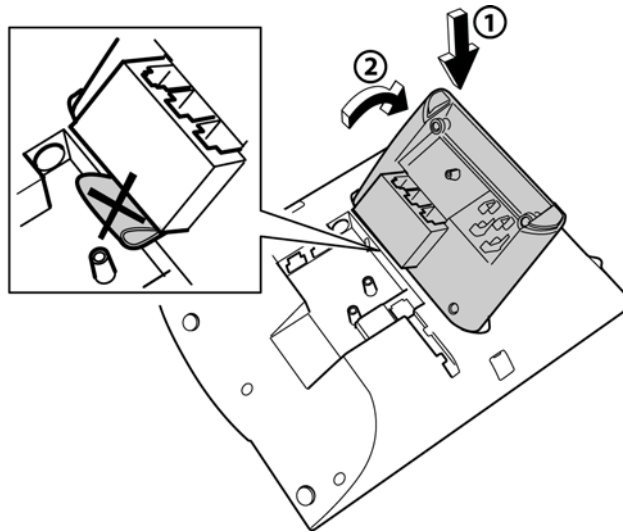

Note: Avoid touching the contacts when you connect the ribbon cable.

4. Connect the cables to the option unit and attach the rubber piece as showed in the figure below.

Apart from the pc and LAN cables, you need connect the auxiliary cable for an extra bell or busy lamp.

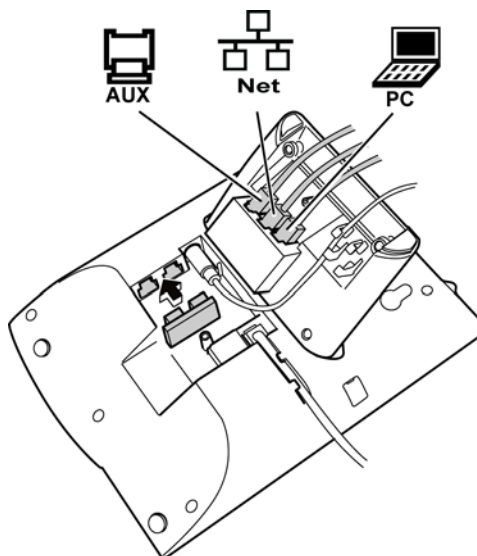

Note: Unless the LAN cable is connected to the port marked **Net** on the option unit, the phone will not work.

5. Attach the ESD covers on the back of the phone to protect the connectors from ESD. For this you need a screwdriver.

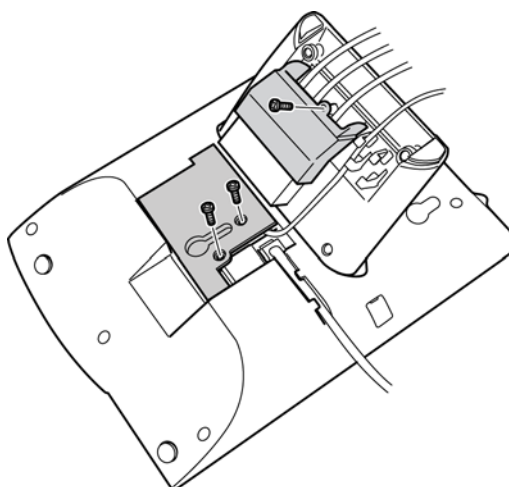

4.4.2

Removing an Option Unit

To remove the option unit, do the following:

1. Disconnect all cables attached to the option unit.
2. Press the unit in the opposite direction to when you installed it.
3. Disconnect the ribbon cable.

4.5 Panel Units (Optional)

It is possible to install up to 3 key panel units (KPU) or 2 display panel units (DPU) in the phone. Each panel unit offers 24 additional keys, allowing you to store the most frequently used phone numbers and features for quick access.

All keys on the optional key panel unit or display panel unit are programmable shortcut keys. For a description on how to program the keys as shortcuts, see 14 Shortcuts on page 84.

Note: It is not possible to have both KPUs and DPUs installed on the same phone.

Key Panel Unit (KPU)

For KPUs, you need to create and print your own key panel designation cards with the names or numbers of the shortcuts. You place the cards under the plastic designation cover of the KPU.

Use the Design Card Manager (DCM) tool to create your own designation cards with shortcut keys. The latest version of the DCM tool can be downloaded from www.aastra.com. For more information, please contact your Aastra Enterprise Certified Sales Partner.

Display Panel Unit (DPU)

DPUs are self-signing, meaning that the name, number, or function that is programmed to a certain key, will be shown in the display next to the key.

4.5.1 Installing a KPU or DPU

1. Disconnect the power from the phone.
2. Remove the rubber pieces on the phone.
3. Attach the KPU or DPU to the phone by inserting the tab on the left side of the unit into the right side of the phone. Press down the unit until you hear a click sound. See figure below.

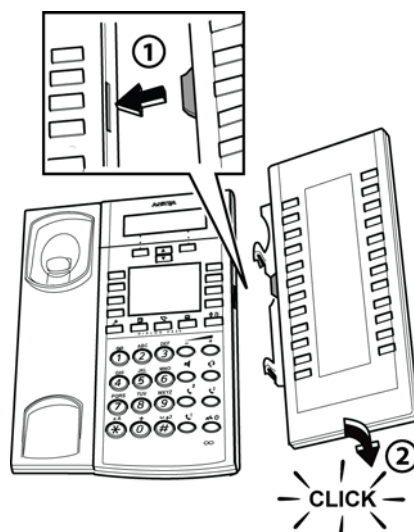

4. Lock the unit, see figure below.

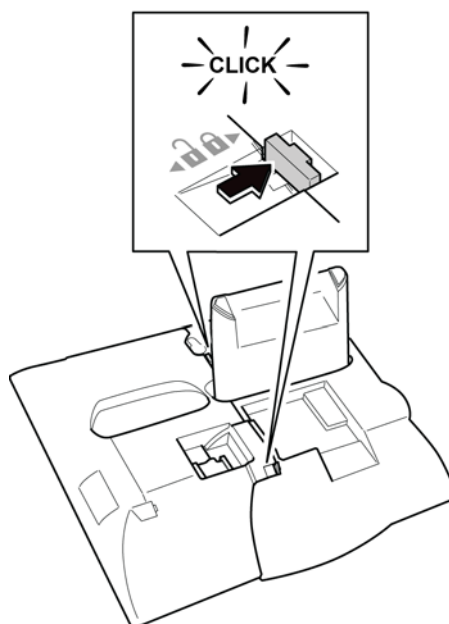

5. Remove the rubber piece from the back of the panel unit.
6. Connect the ribbon cable to the phone. Make sure it fits correctly before pressing it down.

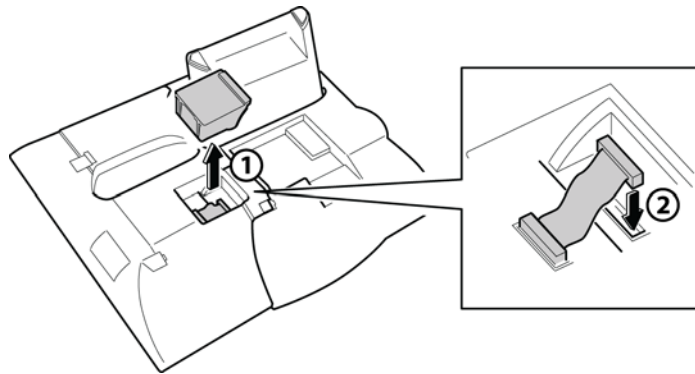

7. Replace the rubber piece.
8. Connect the foot console on the KPU or DPU (the console is enclosed in the box). This is done in the same way as connecting the phone's foot console to the phone.

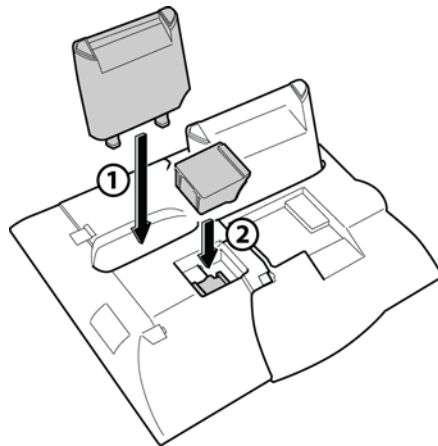

4.5.2 Removing a KPU or DPU

To remove a KPU or DPU, do the following:

1. Disconnect the power to the phone.
2. Disconnect the ribbon cable from the phone.
3. Unlock the KPU or DPU.
4. Press the unit in the opposite direction to when you installed it.

4.6 Wall Mounting

The phone can be wall mounted. For detailed information on how to do this, please see the installation card which comes with the phone.

5 Starting, Logging On and Off

This chapter describes how to start the phone, and how to log on and off. It also describes free seating, and how to check which software version is used.

All system settings for your phone must be set by the system administrator before you can use the phone.

Note: Depending on the settings in your network and telephony system, the startup procedure in your phone may differ from the one described in this manual. Check the display on your phone and read the applicable sections.

5.1 Starting and Logging On

To start the phone, connect the required cables, see figure 11 on page 22. When the phone is connected to the network, the startup procedure starts automatically.

5.1.1 Logging On To the Network

If **LAN access control** is displayed when you start the phone, you need to log on to the network before logging on to the telephony system.

To log on to the network, do the following:

1. Enter the user ID and navigate to the password field.
2. Enter your password and press **Log on**.

Note: If you do not know your user ID or your password, contact the system administrator.

3. The phone receives the network settings.

If the user ID or password is not accepted, the following message is displayed: "Failed Authentication! Check User ID/Password!". Then press **Retry** and make a new logon attempt.

Note: Should the logon fail again, please contact the system administrator.

4. The phone receives the phone settings. If it fails, the phone will use the latest settings.
5. If a new software version is available, you will be notified via a display message.

5.1.2 Logging On To the System

When the phone is logged on to the network, you can either use the phone directly, or you need to log on to the telephony system, see below.

- The phone logs on automatically to the telephony system, and the phone is ready to use. You cannot log on or log off. This mode can be used for phones in, for example, receptions.
- The phone has to be logged on manually to the telephony system before you can use it. You are either required to enter the extension number, or the extension number and a password (or PIN code).

Note: The PIN code can be changed by the user (see 18.8.1 Changing PIN Code on page 113), whereas the password has to be set by the system administrator.

The phone does not work during power failure. After a power failure the phone automatically restarts. When the phone is starting up (rebooting), any PC that is connected to the phone will lose its network connection for about 10 seconds.

5.1.3 Free User

When log off is allowed, the phone must be logged on (registered) to the telephony system before you can use it. When the phone is logged off, the display will look like in figure 14 on page 33. If the emergency call function is enabled, it is possible to make emergency calls. For more information on emergency calls, see 8.3 Emergency Calls (SOS Calls) on page 54.



Figure 14: Logon screen when log off is allowed

The last extension number used (by the previous user) remains until changed.

To log on with your own extension number, do the following:

1. Enter your extension number if it does not already appear in the display.

The displayed number is erased automatically when you start entering new digits. The display shows your entered digits.

2. Press **Log On**.
3. Depending on the configuration, you are logged on automatically, or prompted for login details.
 - If a password (or PIN code) *is not* required, the phone logs on automatically.
 - If a password (or PIN code) *is* required, enter your password (or PIN code) and press **Log On** again.

Note: The password is obtained from, and can only be changed by, the system administrator. The PIN code (if used) can be changed by the user.

4. When your name and number appears in the display, the phone is ready to use.

Note: If the extension number or password is not accepted, an error message is displayed. Then make a new logon attempt. Should the logon fail again, please contact the system administrator.

When a user is logged on and the phone is in idle state, the option **Log Off: [logged on user]** appears when you press the soft key **more....** To log off a user, see 5.2 Logging Off the Phone on page 35.

5.1.4

Temporary User

The phone is logged on with a default number, but you can log on with your individual number and get your user profile.

To log on with your personal extension number, do the following:

1. Press **more....**, select **Log On Temporary User**, and press **Select**.
2. Enter the extension number for the temporary user, and press **Log On**.
3. If password (or PIN code) is required, enter the password (or PIN code) and press **Log On** again.

Note: All temporary users will be logged off from the phones at some point during night.

5.2 Logging Off the Phone

If logging off the phone is allowed, the option **Log off:** [*logged on user*] appears when you press **more....**

To log off from the phone, do the following:

1. Press **more...** when the phone is in idle state.
2. Select **Log off:** [*logged on user*] and press **Select**.

The following message is displayed: “Log off?”

3. Press **Yes** to confirm.

Press **No** to cancel.

- If the logged off user was a temporary user, the permanent user is logged back on automatically.
- If no user is logged on, only emergency calls are possible.

Note: If the emergency call function is disabled, the message “No calls!” is displayed. For more information on emergency calls, see 8.3 Emergency Calls (SOS Calls) on page 54.

5.3 Automatic Shut Down of the Phone

The system administrator can enable to shut down the phone at a certain time each 24 hours (for power saving reasons). To power up the phone again the user has to do the following:

- Press .

It takes 1-2 minutes before the phone has started and you get the log on menu.

- If your extension number **does not** have an associated PIN code, the telephone registers to the PBX automatically.
- If your extension number **has** an associated PIN code, you need to enter your PIN code.

The reason why you have to enter your PIN code is that otherwise anybody could power up the telephone and make calls without your knowledge.

5.4 Shutting Down the Phone

To shut down the phone, do the following:

1. Press and hold .
2. Select **Shut down the phone?** and press **Select**.
A shutdown warning message is displayed.
3. Press **Yes** to confirm.
 - If you press **No**, you are returned to the previous state.
 - If you are interrupted by an incoming call before you press **Yes**, the shutdown is cancelled.
 - If no confirmation action is carried out within 10 seconds, the shutdown is cancelled.

To power up and start the phone again:

- Press .
- It takes 1-2 minutes before the phone has started and you get the log on menu.
- If your extension number **does not** have an associated PIN code, the telephone registers to the PBX automatically.
 - If your extension number **has** an associated PIN code, you need to enter your PIN code.
The reason why you have to enter your PIN code is that otherwise anybody could power up the telephone and make calls without your knowledge.

5.5 Restarting the Phone

If your phone does not work properly, you can restart it.

To restart the phone, do the following.

1. Press and hold .
2. Select **Restart the Phone**, and press **Select**.
The message “Restart the phone?” is displayed.
3. Press **Yes** to confirm and restart the phone. This may take a few minutes.
4. Enter the user id in the field *Log on with* and select **Log on**.

5.6 Updating the Phone Software

When new software is available, the message “A new version of the telephone software is available. Update recommended.” appears in the phone display.

You then have 60 seconds to decide if you want to update the software to the latest version.

- Select **No** to skip the update and keep the current software version.
- Select **Yes** to start downloading the software update from the software server. The update process takes approximately 60 seconds to complete, and the progress is displayed on screen.
 - When the update is successful, the phone reboots, and it is then ready to use, or ready for logon, see 5.1 Starting and Logging On on page 32.
 - If the update fails, the phone will use the old software version, and you can start using, or log on when you press **OK**.
- If no key is pressed within 60 second, **Yes** is selected automatically, and the update will be installed.

Note: It is important that you do not disconnect the phone power supply while the new software is being downloaded and saved. If a power failure occurs, the software must be downloaded again.

5.7 Software Version

To view which software version is installed currently, do the following:

1. Press .
2. Select **Help** and press **Select**.
3. Select **About Aastra 7444ip** and press **Select**.

The software version is displayed at the top row.

4. Press **Back** to return to previous menu.

Note: Press  to return directly to the idle display.

5.8 Free Seating

The *free seating* feature enables you to log on to your IP extension from any IP phone that allows temporary or free users. This means that the IP phones automatically work as free seating phones within the network.



When you log on with your extension number from another phone, your personal settings are moved to that phone.

6 Handsfree and Headset





This chapter describes how to answer and make calls in handsfree mode or by using a headset.

The standard mode of answering and making calls is to lift the handset, and this is also the default mode in the procedures described in this user guide. However, it is often more convenient to use handsfree mode, or a headset when handling calls. See below for detailed descriptions of both options.

6.1 Handsfree Mode

In handsfree mode you do not lift the handset to start a procedure. And to end a call, you press   instead of replacing the handset.

By default, the phone is set to connect calls to the loudspeaker when you answer incoming calls, or when you make calls by pressing a line key. This default setting is known as *the loudspeaker preset mode*. When you dial a number without lifting the handset, the call is also connected to the loudspeaker by default.



Action	Procedure
Answer a call	Press the line button that indicates an incoming call (the button's indicator is flashing) or press Answer .
Make a call	Dial the number you want to call. When someone answers, the speakerphone is activated. Then you can pick up the handset, or continue to use the speakerphone.
Clear a call	Press   .
Switch from handsfree to handset	Lift the handset.
Switch from handsfree to headset	Press  .
Switch from handset to handsfree	Press  and replace the handset.

Action (Cont.)	Procedure (Cont.)
Switch from headset to handsfree	Press  .





6.2 Headset

Using a headset allows you to make and receive calls without using the handset.



The telephone supports wireless headsets that enable the user to answer and end calls remotely, via the headset.

- If you are using a *wired headset*, connect the *headset cable* to the connector marked .
- If you are using a *wireless headset*, connect the radio base to the connector marked .

Note: Using a wired headset requires an adapter cable, see 2.1.2 Required Headset Adapter on page 4.

Action	Procedure
Answer a call	Press  .
Make a call	Press  and dial the desired number. In headset preset mode, you are not required to press the headset key.
Clear a call	Press  .
Change the volume	Press  to change the volume. The new volume setting is stored.
Switch from headset to handset	Lift the handset.
Switch from handset to headset	Press  and replace the handset.

By default, the phone is set to connect calls to the loudspeaker. If you are using a headset, you can switch to the headset preset mode to have calls connected to the headset instead.

Action	Procedure
Activate Headset Preset	Press  and hold for at least 4 seconds. A short acknowledgement signal is heard, and the headset icon appears in the display.
Deactivate Headset Preset	Press  and hold for at least 4 seconds. A short acknowledgement signal is heard, and the headset icon disappears from the display.

Note: When you lift the handset, the call is always connected to the handset, regardless of the type of preset setting. Activation and deactivation of **Headset Preset** can only be done when the phone is in idle mode.

7 Incoming Calls

This chapter describes how to answer and reject incoming calls, how to pick up calls on other extensions, and how to check missed calls.

7.1 Receiving Calls

An incoming call is indicated by a ring signal, and a flashing indicator associated with the line on which the call is presented. The phone display shows the caller's number, and name if available.



Note: If the feature parallel ringing is activated, the call will ring on more than one phone, see 7.6 Parallel Ringing on page 46.

7.1.1 Answering a Call

You can answer incoming calls in handset mode or handsfree mode:

- *Handset:* Lift the handset. The call is received on the line represented by a flashing line button.
- *Handsfree:* Press the soft key **Answer** or the flashing line button without lifting the handset. (You can switch to handset mode at any time by lifting the handset.)

7.1.2 Rejecting a Call

If you are busy, you can reject the call by pressing the soft key **Reject** or the   button. The caller will hear a busy tone, and the call is disconnected.

7.2 Picking Up Calls

You can answer calls to your extension from another phone, as well as answer calls to another extension from your phone. This feature is known as *picking up* calls.

Note: Some phones can be protected against call pick-up.

To pick up a call, do the following:

1. Lift the handset and call the ringing extension.



- When you get a busy tone, press **CallPickUp**.

7.3 Missed Calls

If you have unanswered calls, this is indicated by a flashing indicator lamp on the call list key. A message appears in the display with information about the number of missed calls, see below.



To check your missed calls, do the following:

- Press **Select** or the call list key  to enter the call list. The missed calls tab is active.
The flashing call list indicator changes to a steady light.
- Step through the call list by pressing the navigation keys .
- Exit the call list by pressing the call list key .

The call list key indicator is turned off, and the status information disappears from the display.

7.4 Automatic Answer

It is possible to set incoming calls to be answered automatically in handsfree mode. This means that you get speech connection without having to perform any action. The feature is called *automatic answer*.

These are the settings for the automatic answer feature:

Auto Answer OFF The feature is disabled. (This is the default setting.)

Auto Answer ON The call is answered immediately, no ring signal is heard.

Delayed Auto Answer One ring signal is heard before the call is answered.

Note: Changing the automatic answer settings requires administrator rights, but you can view the current setting.

To view the automatic answer settings, do the following:

1. Press .
2. Scroll down to **Auto Answer** and press **Select**.

The current setting is displayed.

7.5 Answering a Second Incoming Call

You have three access lines for incoming and outgoing calls. All lines have the same extension number. This feature is called *triple access line*.

Note: To be able to receive a second incoming call, the feature *Free on busy* must be activated, see 7.5.1 Activating Free on Busy on page 45. A call waiting call can be answered although *free on busy* is not activated.

To answer a second incoming call, do the following:

1. The second incoming call is indicated by a flashing line key and information about the caller, see figure below.



2. Press the flashing line key to answer the second call. The first call is put on hold automatically.

7.5.1 Activating Free on Busy

To activate Free on busy, do the following:

- Press the **Free on busy** shortcut key. The key indicator is lit.

OR

1. Press the **Availability** soft key.
2. Navigate to **Free on busy: OFF** and press **Select**.
3. Select the option **ON, put call through** and press **Select**.
4. Press **Back** to return to the idle display.

Note: If you have ongoing calls on line 1 and on line 2 and if there is a new call received on line 3, you cannot transfer any of the calls to a fourth part.

7.5.2 Deactivating Free on Busy

To deactivate Free on busy, do the following:

- Press the **Free on busy** shortcut key. The key indicator is turned off.

OR

1. Press the **Availability** soft key.
2. Navigate to **Free on busy: ON** and press **Select**.
3. Select the option **OFF, send busy on busy** and press **Select**.
4. Press **Back** to return to the idle display.

7.6 Parallel Ringing

Parallel ringing makes it possible for an incoming call to ring several phones simultaneously and for the call to be answered on any of these phones. The main advantage of this feature is that you do not risk losing any calls.

The parallel ringing feature requires all phones involved to be defined in a parallel ringing list, which is set up by the system administrator. Only calls to a predefined main extension will be distributed to the phones on the parallel ringing list. Incoming calls to other extensions will ring only on their respective extensions.

To answer a parallel ringing call, lift the handset on any of the ringing extensions.

7.6.1 Disabling Parallel Ringing

You can disable parallel ringing temporarily by activating Follow-me.

Disabling On Your Phone

To disable parallel ringing on one phone in the parallel ringing list, you activate Follow-me to *the main extension*. For more information, see 10 Call Forwarding on page 61.

Disabling On All Phones

To disable parallel ringing on all phones in the list, you activate Follow-me to *all extensions except the main extension*. For more information, see 10.1.1 Ordering Follow-me From Own Telephone on page 61.

7.6.2 Restoring Parallel Ringing

To restore parallel ringing, deactivate Follow-me.

Restoring On Your Phone

To restore parallel ringing on one phone in the list, deactivate Follow-me from that phone, see 10.1.2 Canceling Follow-me From Your Own Telephone on page 62.

Restoring On All Phones

To restore parallel ringing on all phones in the list, deactivate Follow-me from these phones, see 10.1.6 Canceling Follow-me Remotely on page 64.

8 Outgoing Calls

This chapter describes how to make outgoing calls, and lists the options available to you when you receive a busy tone or no answer.

8.1 Making Calls

To make a call, you either dial a number, press a shortcut, dial an abbreviated number, or find the contact stored in the phonebook.

8.1.1 Dialing by Numbers

You can call internal extensions as well as external numbers from your phone. To dial an external number, you must first enter an *external access code*. The external access code, which is used in your office to get an external line, consists of one or more digits, for instance 0 or 00.

To dial a number, do the following:

- 1) Lift the handset.
- 2) When you hear a dial tone, dial the number.
 - For internal calls, dial the extension.
 - For external calls, enter the external access code and dial the external number.

Note: If you prefer handsfree mode, dial the number without lifting the handset. (You can switch to handset mode at any time by lifting the handset.)

8.1.2 Dialing by Shortcuts

Shortcut keys can hold both features and phone numbers. See 14 Shortcuts on page 84 for information on how to program shortcut keys.

- To dial by a shortcut key, press the desired shortcut key.

Note: If the shortcut is not visible in idle mode, press  to open the shortcuts menu and scroll to the page containing the desired shortcut and press its key.

8.1.3 Abbreviated Dialing

Frequently used phone numbers can be stored in the exchange as *common abbreviated numbers*, that is, a few digits that represent a complete internal or external number.

Note: Common abbreviated numbers are programmed by the system administrator and are stored in the telephony system.

To dial using abbreviated dialing, do the following:

1. Lift the handset and wait for a dial tone.
2. Dial the abbreviated number.

8.1.4 Calling a Contact

To call a contact, do the following:

1. Press and hold the numeric key (2-9) with the initial letter of the name of the contact you wish to call.
2. Navigate to the desired contact and press **Call**.

8.1.4.1 Specifying a Search

To search a contact from the *idle screen*, do the following:

- To find all contacts beginning with the letters A, B, or C, press and hold the numeric key 2. To find all contacts beginning with the letters D, E, or F, press and hold the numeric key 3, and so on.

Note: When you hold and press a numeric key, the contacts list opens, and from here you can specify your search, see below.

To search a contact from the *contacts list*, do the following:

- To find all contacts beginning with letter A, press 2 once, and to find all contacts beginning with letter B, press 2 twice, and so on.
- To find a contact beginning with "Ab", hold and press 2 once to display the letter A. Then press 2 twice in a row to display the letter B after A.

8.1.5 Redialing External Numbers

When you call an external number, the system automatically stores all dialed digits, regardless of whether the call is successful or not. This enables you always to redial the last dialed external number.

You can also redial numbers using the call list, see 11.1 Dial a Call List Item on page 71.

To redial the last dialed external number, do the following:

- 1) Lift the handset and wait for a dial tone.
- 2) Dial *******. The last dialed external number is automatically redialed.

Note: Finland and Sweden: Dial ****0**.

8.2 When You Receive a Busy Tone or No Answer

If you call an extension number and you receive a busy tone or get no answer, or if all external lines are busy, you can try again later, or you can order *callback*, *call waiting*, *intrusion*, or *bypass*.

8.2.1 Callback

You can order callback in the following cases:

- If the extension number you have called is busy or does not answer. You can have several callbacks activated at the same time.
- If all external lines are busy. You can have only one callback activated on a busy external line.

Note: While waiting for a callback, you can make and receive calls.

If you order callback when you receive a busy tone, you will be called back as soon as the extension or line becomes free. If you order callback when there is no answer, you will be called back when the extension has been used the next time.

Note: When you return to the office, you can tell the system that you are present by lifting the handset and immediately replacing it.

8.2.1.1 Ordering Callback

To order callback, do the following:

- 1) Press the **Callback** shortcut key.

When the procedure is executed, the status message "Accepted" is displayed.

- 2) Replace the handset to finish the procedure. (In handsfree mode, press **Clear**.)

Note: When the other party becomes available, you will receive a callback alert.

8.2.1.2 Ordering Callback When All External Lines Are Busy

If all external lines are busy (after dialing the digit or digits to get an external line), do the following:

1. Press the **Callback** shortcut key.
Wait for dial tone.
2. Dial the external number (or part of the number, or no number) and press **#**.
 - You can have a callback on the external line, that is, you will be notified when the external line is free without specifying the external number to call.
 - You can enter a number that will be dialed automatically when you answer the callback call.
 - You can enter part of the number, and dial the remaining digits when you answer the callback call.
3. Replace the handset. (In handsfree mode, press **Clear**.)

Note: When the external line becomes available, you will receive a callback alert.

8.2.1.3 Answering Callback

When the extension number or external line becomes free you will receive a callback alert, which means that you will hear a ring signal that you need to answer.

To answer a callback alert, do the following:

1. When you receive the callback alert, lift the handset. (In handsfree mode, press **Answer**.) You will hear the ring tone.

If you have ordered callback for an external line, you may be prompted to enter any remaining digits.

Note: You have to answer the callback alert within 8 seconds, otherwise the callback will be cancelled.

2. The system calls the number you have requested for callback.

8.2.1.4 Canceling All Callbacks

To cancel all callbacks, do the following:

- 1) Select **Cancel all Callbacks**, and press **Select**.

The message "Callbacks are pending. Delete all?" is displayed.

- 2) Press **Yes** to confirm, or **No** to cancel.

Note: This procedure cancels all callbacks to extension numbers and busy external lines.

8.2.1.5 Canceling a Single Callback

To cancel a single callback, do the following:

- 1) Lift the handset and wait for a dial tone.
- 2) Dial # 37 * *extension number* #.
- 3) Replace the handset.

Note: To cancel a single callback on an external line, enter the digit or digits required for a line, rather than the extension number.

8.2.2 Call Waiting

If you urgently wish to contact a busy extension, you can send a notification using a *call waiting* signal. Call Waiting is indicated either by a tone (if the busy extension is an analog extension), or as a second call (if the busy extension is a digital system phone or an IP phone).

Note: If the called extension does not accept call waiting, you will continue to hear a busy tone. If the called extension ignores the call waiting signal, you can order callback, see 8.2.1 Callback on page 50.

8.2.2.1 Activating Call Waiting

To send a call waiting signal to a busy number, do the following:



1. Press **CallWaiting**.
2. Keep handset off hook. If the called party answers your call waiting request, the call will be established. If the called party does not want to answer your call, you will continue to hear the ring tone until you go on hook.

8.2.2.2 Answering a Call Waiting Call

When you get a call waiting indication (call waiting tone or ring signal and a line key  is flashing), there are the following possibilities:

1. Park the ongoing call.
2. End the ongoing call.
3. Reject the call waiting request.

If you want to park the ongoing call, do the following to answer the call waiting call:

1. When the ongoing call is on one of the line keys  and another line key  flashes to indicate the call waiting call.
2. Press the flashing line key . The call on the other line is automatically parked.
3. To retrieve the other call press the line key again.



If you want to end the ongoing call and then answer the call waiting call:

1. End the ongoing call.
2. Wait for ring signal.
3. Lift the handset to answer the waiting call.

If you want to reject the call waiting request:

1. Press **Reject**.
2. Continue with the ongoing call.

8.2.2.3 Canceling Call Waiting

To cancel call waiting, replace the handset. You can also press  .

8.2.3 Intrusion

You can intrude on an ongoing call on a busy extension.

Note: If intrusion is not allowed at either the calling extension or the called extension, you will continue to hear a busy tone.

Before the intrusion is executed, an intrusion tone is sent to the parties in the ongoing call as a warning. After the intrusion is executed, all parties will hear the intrusion tone. The intrusion tone will be heard as long as all parties are connected.

Note: The intrusion feature is enabled by the system administrator. This means that intrusion can be blocked for use on your extension.

Also, the system administrator can disable the intrusion tone in the system

8.2.3.1 Ordering Intrusion On a Busy Extension

To intrude on an ongoing call, do the following:

1. Press **more....**
2. Select **Intrusion**, and press **Select**.

8.2.4 Bypass

If you need to get through to an extension forwarded through follow-me or any kind of diversion, you can bypass the diversion.

8.2.4.1 Bypassing a Diverted Extension

To request bypass for a diverted extension, do the following:

1. Lift the handset and wait for a dial tone.
2. Dial **60* extension number #*.
3. Wait for answer.

Note: U.S. and Canada: Dial **1* extension number #*.

8.3 Emergency Calls (SOS Calls)

This section describes how to make emergency calls in different modes.

The emergency call feature allows you to make emergency calls even when the phone is not logged on to the exchange. The emergency call feature is enabled by the network administrator.

Note: If the emergency call feature is disabled, emergency calls are *not* possible when the phone is logged off the exchange.

8.3.1 The Phone Is Logged On

1. Dial the emergency number (SOS number) and wait an for answer.

8.3.2 The Phone Is Logged Off, Emergency Call Enabled

When the emergency call feature is enabled, you can make emergency calls even when the phone is logged off. The display looks like this:



Figure 15: Phone logged off, emergency call enabled

1. Dial the emergency number (SOS number) and wait an for answer.

When the emergency call has been terminated, the emergency centre can call back to your phone even though it is logged off.

8.3.3 The Phone Is Logged Off, Emergency Call Disabled

When the emergency call feature is disabled, the SOS text does not appear at the bottom of the display, which means that you cannot make emergency calls unless you log on the phone. The display looks like this:

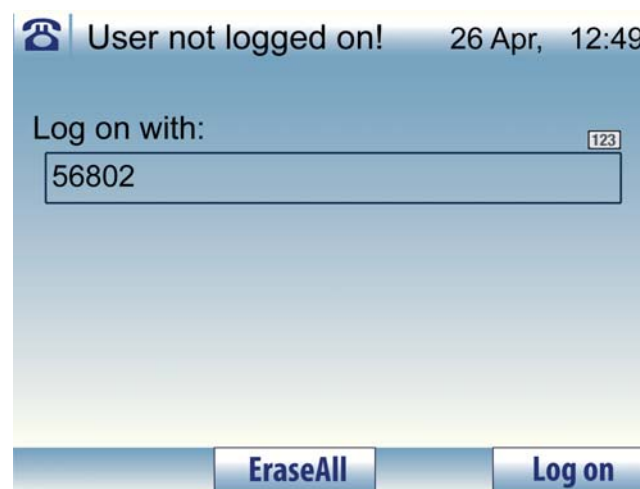

Figure 16: Phone logged off, emergency call disabled

1. Log on with your extension number, then call the SOS number.

8.4 Number Presentation Restriction

If you do not want your name and number to be displayed to the person you are calling, you can hide the number by ordering *number presentation restriction*.

When you have ordered number presentation restriction, the text “Anonymous” will appear in the display of the phone you are calling. The number presentation restriction is valid only for the current call, which means that the procedure has to be repeated the next time you want to use it.

Note: Number presentation restriction can be blocked on your extension. Contact the system administrator for more information.

8.4.1 Ordering Number Presentation Restriction

To order number presentation restriction from your phone, do the following:

1. Lift the handset.
2. Dial *42#.
Wait for a dial tone.
3. Dial the desired number.

8.5 Individual External Line

To call an *individual external line*, do the following:

1. Lift the handset.
2. Dial *0*, *individual external line number #*.
3. Dial the external number.

9 During Calls

This chapter describes a number of features that you can activate during an ongoing call. Placing a call on hold, making a transfer, and starting a conference are a few examples.

During an ongoing call, the display shows information about the dialed (or called) number and name (if available) and the duration of the call. See example below.

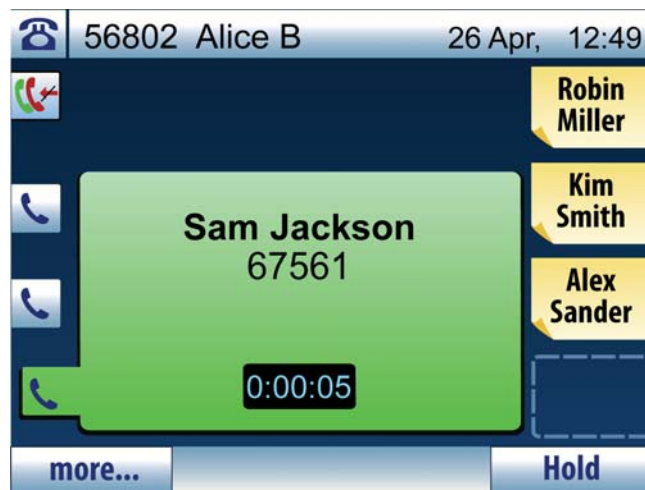

9.1 On Hold

Putting a call on hold means that you park a call temporarily in order to, for instance, make an inquiry to a third party. You can put extension numbers as well as external numbers on hold.

9.1.1 Putting a Call On Hold

To put an ongoing call on hold, do the following:

- Press the line key for the ongoing call.

OR

- Press **Hold** for the ongoing call.

9.1.2 Retrieving a Call On Hold

To retrieve a call on hold, do the following:

- Press the line key for the call on hold.

OR

- Press **more...**, select **Retrieve** [*call on hold*], and then press **Select**.

9.2 Inquiry

When you make an inquiry, you place an ongoing call on hold while calling a third party.

9.2.1 Making an Inquiry

To make an inquiry to a third party, do the following:

1. Press **Hold** (or any line key).
2. Enter the number to the third party.

When the third party answers, you can switch between the calls, transfer the call, create a conference or end the active call.

9.2.2 Switching Between Calls

You can switch between the ongoing call and the call on hold. When you do this, the call that was put on hold is retrieved, and the active call is put on hold.

To switch between calls, do the following:

- Press the line key for the call on hold.

OR

Press **more...**, select **Retrieve** [*call on hold*], and then press **Select**

Note: You can terminate the ongoing call by replacing the handset or pressing . The call on hold still remains and can be retrieved.

9.3 Transfer

You can transfer a call to an extension number, an external number, your mobile phone, or to the operator. The call can be transferred either before or after the third party answers.

Note: If you have put more than one call on hold, the last call that was put on hold will be transferred. If the dialed extension is busy, or if transfer is not allowed, your phone will ring again.

9.3.1 Transfer to Another Number

To transfer an ongoing call to another number, do the following:

1. Press **Hold** or the line key used for the ongoing call.
2. Dial the number that you wish to transfer the call to. The number can be an extension or an external number.
3. Press **Transfer** before or after answer.

The call is transferred.

9.3.2 Transfer to Your Mobile Phone

Note: To be able to transfer a call to your mobile phone, you have to program your mobile phone number. See 18.1.5 My Mobile Phone on page 107) for instructions.

To transfer an ongoing call to your mobile phone, do the following:

1. Press **more...** during the ongoing call.
2. Select **Transfer to My mobile**, and press **Select**.

Transfer will be done before answer.

9.3.3 Transfer to Operator

Note: The possibility to transfer a call to the operator is enabled by the system operator.

To transfer an ongoing call to the operator, do the following:

1. Press **more...** during the ongoing call.
2. Select **Transfer to Operator**, and press **Select**.

Transfer will be done before answer.

9.4 Conference

If you have an ongoing conversation and wish to establish a phone conference, you will become the conference leader. If the conference leader leaves the conference, the first added participant will become the

new conference leader, and the conference continues with the other included parties. When there are only two parties left, the conversation is changed back to a normal two party connection.

You can add up to 6 participants in a conference. Only the person initiating the conference, the *conference leader*, can add participants.

To establish a conference, do the following:

1. Press **Hold**, or the line key used for the ongoing call.
2. Call the third party.
Wait for answer.
3. Press **Conference**.
4. Repeat the procedure to add more conference members.

A conference tone is heard throughout the conference.

Note: The conference tone might be disabled for your system.

To leave the conference, replace the handset or press  .

9.5

Suffix Dialing (DTMF)

When communicating with and controlling a voice mail system, or when retrieving information about your bank account through your phone, you need to use Dual Tone Multi-Frequency (DTMF) signals, also known as *suffix dialing*.

The suffix dialing function is always active for all calls in speech.

All digits entered are converted automatically to DTMF signals, which are transmitted along the connected lines.

10 Call Forwarding

This chapter describes different ways to forward incoming calls to other numbers, or the operator.

The type of call forwarding described in this chapter is called *Follow-me*. Follow-me is useful when, for example, you are working temporarily from another room and want your calls to follow you to that room, or if you want your incoming calls to be forwarded to one of your extension number.

Another type of call forwarding is when you *divert* your calls to the operator or your voicemail due to absence of some kind, see 13 Presence Information on page 82.

When you order follow-me, the feature is indicated in the phone display. The display informs you whether the extension is being forwarded to another extension or an external number. The Follow-me key indicator is also lit.

Note: When Follow-me is activated, your phone can still be used for outgoing calls. As a reminder, you will hear a special dial tone when you lift the handset.

10.1 Follow-Me

Follow-me allows you to redirect incoming calls to another extension within the network. You can enter the number manually or from a contact.

10.1.1 Ordering Follow-me From Own Telephone

To order Follow-me from your extension to another extension, do the following:

1. Press the soft key **Availability**.
2. Select **Follow-me** and press **Select**.
3. Enter the *new answering position number*.

OR

Press **more...**, select **Set from Contacts** and press **Select**. Select a contact and press **Set**.

4. Press **Done**.

The display shows the text “FollowMeTo” followed by the answering position number. The Follow-me key indicator is lit.

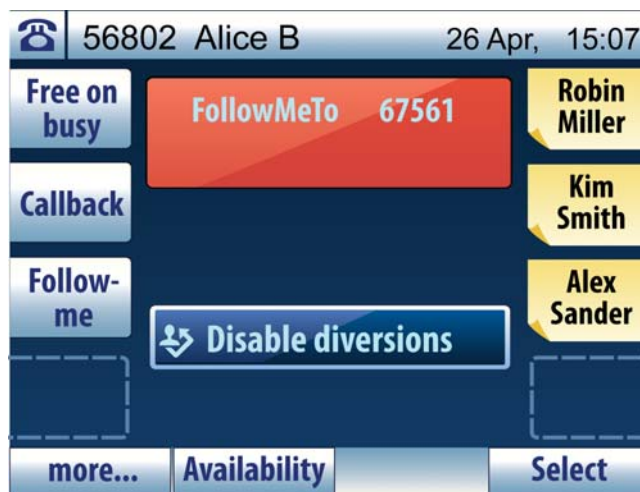

When you lift the handset again, a special dial tone is heard.

Note: The Follow-me key works only as an indicator that follow-me is activated. Follow-me cannot be activated, only cancelled, by pressing this key.

10.1.2

Canceling Follow-me From Your Own Telephone

To cancel Follow-me and all other diversions, from own extension, do the following:

- Press the Follow-me key.

OR

- Select **Disable diversions** in the idle list and press **Select**.

The indication of the active follow-me on you own phone disappears.

To cancel Follow-me but keep any other diversion, do the following:

1. Press the soft key **Availability**.
2. Select **Follow-me**, and press **Select**.
3. Select **Deactivate Follow-me**, and press **Select**.

10.1.3

Ordering Follow-me From Another Telephone

You can order follow-me of your own extension number from another telephone.

The first step is to allow that follow-me is permitted to be done from another telephone. Do the following from your own telephone:

1. Press the soft key **Availability**.
2. Select **Follow-me** and press **Select**.
3. Enter your *own extension number*.
4. Press **Done**.

The display shows the text "FollowMeTo" followed by the answering position number. The Follow-me key indicator is lit.

To order follow-me from another telephone:

1. Lift the handset and wait for dial tone
2. Dial **21*own extension number * extension number of the new answering position#*
3. Wait for special dial tone
4. Replace the handset

10.1.4 **Canceling Follow-me From Another Telephone**

To cancel follow-me of your own extension number from another telephone:

1. Lift the handset and wait for dial tone
2. Dial *#21*own extension number#*
3. Replace the handset

The indication of the active follow-me on you own phone disappears, if there is no additional diversion remaining.

10.1.5 **Ordering Follow-me Remotely**

With this feature you can order follow-me of any extension number from any telephone.

The prerequisite is that all the involved telephones have the right service profile.

To order remote programming of follow-me do the following:

1. Lift the handset and wait for dial tone
2. Dial **21*extension number to divert * extension number of the new answering position#*
3. Wait for special dial tone
4. Replace the handset

10.1.6 Canceling Follow-me Remotely

To cancel remote programming of follow-me from another telephone than the telephone with the diverted number:

1. Lift the handset and wait for dial tone
2. Dial #21**diverted extension number*#
3. Replace the handset

The indication of the active follow-me on the telephone with the diverted number disappears, if there is no additional diversion remaining.

10.2 External Follow-Me

External Follow-me allows you to redirect incoming calls to an external number of your choice.

You can enter the number manually or from a contact.

Note: To be allowed to order External Follow-me, your service profile must include this feature. For more information, please contact the system administrator.

10.2.1 Ordering External Follow-me From Your Own Telephone

To order external Follow-me from your own phone, do the following:

1. Press the soft key **Availability**.
2. Select **External Follow-me** and press **Select**.
3. Enter the *external access code + the external number*.

OR

Press **more...**, select **Set from Contacts** and press **Select**. Select a contact and press **Set**.

4. Press **Done**.

The display shows the text “Diverted to external. The Follow-me key indicator is lit.



When you lift the handset again, a special dial tone is heard.

Note: The Follow-me key works only as an indicator that follow-me is activated. Follow-me cannot be activated, only cancelled, by pressing this key.

10.2.2

Canceling External Follow-me From Your Own Telephone

To cancel external Follow-me, and all other diversions, from own extension, do the following:

- Press the Follow-me key.

OR

- Select **Disable diversions** in the idle list and press **Select**.

The indication of the active external follow me on your own telephone disappears.

To cancel external Follow-me but keep any other diversion, do the following:

1. Press the soft key **Availability**.
2. Select **External Follow-me**, and press **Select**.
3. Select **Deactivate External Follow-me**, and press **Select**.

10.2.3

Ordering External Follow-Me Remotely

With this feature you can order external follow-me of any extension number from any telephone.

The prerequisite is that all the involved telephones have the right service profile.

To order programming of external follow-me for another extension, do the following:

1. Lift the handset and wait for a dial tone.
2. Dial **22* extension number to divert # route access code and the external number #*
3. Replace the handset.

The Follow-me key is lit and the and the display shows the external follow-me text, on the telephone that has been diverted.

10.2.4

Canceling External Follow-me Remotely

To cancel the remote programming of external follow-me for another extension, do the following:

1. Lift the handset and wait for a dial tone.
2. Dial *#22* diverted extension number #*.
3. Replace the handset.

10.3

Personal Number and Profiles

With the personal numbers and profiles feature a number of answering positions can be defined in a profile. When somebody calls your normal office phone number the call will be announced on the telephones defined in your active profile.

A search profile can be designed to fit the situation (in the office, traveling, at home, and so on). Both internal or external phone numbers can be used in a profile. Maximum five profiles can be defined.

Your search profile is programmed or modified by your system administrator. You can also manage your profiles yourself by using the CMG Office Web application, if available. Contact your system administrator for more information

When the feature is activated, incoming calls are transferred to your selected phones or backup services in the order that you choose. If an answering position in the profile is busy, the call can be transferred to another predefined position in the profile (VoiceMail or a colleague).

With the personal numbers and profiles feature you can be reached at your office phone number when you are out of the office.

Depending on the functionality of your telephony system, you can have either one individual single search profile (standard) or you can choose between 5 individual search profiles (optional).

You can also use the CMG Office Web application, if available. Contact your system administrator for more information.

10.3.1 **Activating Or Changing Profiles From Your Phone**

To select a profile from your phone, do the following:

1. Press **Availability**, select **My Profile**.
2. Enter the search profile digit (1-5).
3. The profile number (or name) is shown in the display.

10.3.2 **Canceling a Profile From Your Phone**

To cancel a profile from your phone, do the following:

1. Press **Availability**, select **My Profile**.
2. Select **No Profile**
3. The profile number (or name) disappears from the display.

10.3.3 **Activating Or Changing Profiles From an External Phone**

The external phone must be of push button type provided with a pound key (#) and a star key (*), or a mobile phone adapted for dial tone pulses (DTMF).

1. Call the DISA feature at your office.
Wait for dial tone.
2. Dial **75* authorization code #*.
3. Dial *own extension number #*.
Wait for dial tone.
4. Dial **10* own extension number #*, enter the search profile digit (1-5) and press #.
5. Replace the handset.

Note: If VoiceMail is included in the activated profile, make sure to always update your greeting with Absence Information.

10.3.4 Canceling a Profile From an External Phone

The external phone must be of push button type provided with a pound key (#) and a star key (*), or a mobile phone adapted for dial tone pulses (DTMF). To cancel, do the following:

1. Call the DISA feature at your office.
Wait for dial tone.
2. Dial **75* authorization code # own extension number #*.
Wait for dial tone.
3. Dial *#10* own extension number #*.
4. Replace the handset.

10.3.5 Designing Profiles

When you are creating your search profiles, you should consider the following:

- Avoid ring times longer than 45 seconds for your profiles.
Callers typically hang up after 3-6 ring signals.
- Consider the time you need to react and answer on each answering position in your profile. You might need up to 15 seconds to react and answer a call on a desk or cordless phone, and 20-25 seconds for a mobile phone.
- There must be an answering position at the end of every profile (VoiceMail or operator/secretary). If not, calls may be unanswered.
- Consider how you want incoming calls to be handled while you are busy on a phone. Available options are:
 - Activate Free on Busy (if available)
 - Follow-me to VoiceMail
 - Follow-me to the operator
- If an answering machine, a fax or other answering device is used as an early answering position, it might interfere with the searching. Disconnect the answering device, or design the ring times so they do not affect the searching.
- Make sure you use as few answering positions as possible for each profile. Profile examples:
 - In office
 - At home

- Traveling
- Absent/not reachable

10.3.5.1

Example Profiles

Table 6 Example Profile 1 - In office

Search order	Type of phone or answering position Examples: Desk, Cordless, Mobile, External, Voice Mail, Operator, and so on	Phone number	Ring time (seconds)
1	Desk	12345	10
2	Cordless	52341	15
3	Voice Mail	55555	

Table 7 Example Profile 2 - At home

Search order	Type of phone or answering position Examples: Desk, Cordless, Mobile, External, Voice Mail, Operator, and so on	Phone number	Ring time (seconds)
1	External	00082222222	20
2	Mobile	0706666666	25
3	Voice Mail	0822255555	

11

Call List

This chapter describes the call list and its features.



The phone keeps a call log of 50 positions listing received calls, missed calls, and dialed calls.



Each item in the call list contains detailed information about the call. From the call list, , you can call and remove call list items, and add them as contacts or shortcuts.



- An icon next to each item tells you which type of call it is.
- Each call type has its own tab in the call list, which you can open by pressing its key. The topmost tab includes all calls, both received, missed, and dialed.
- The name and/or number of the caller appears to the left in the display.
- Details about the date or time the call was made, and the duration of the call are displayed to the right. If you press **Details** for a selected call list item, all call details are shown in the display.



Table 8 Call List Icons

Icon	Description
	This icon indicates any type of call.
	This icon indicates dialed calls.

Icon (Cont.)	Description (Cont.)
	This icon indicates received calls.
	This icon indicates missed calls.

11.1 Dial a Call List Item

To dial from the call list, do the following:

- 1) Press the call list key  to open the call list.
The latest call appears highlighted at the top of the display.
- 2) Scroll the call list with the navigation keys .
- 3) Select the desired position in the call list and press **Call**.

11.2 Add a Call List Item

You can add a call list item to your contacts or add it as a shortcut.

Note: The digits can be stored by adding the country code number after a plus sign, for example +46 8 719 0000.

11.2.1 Adding a Call List Item To the Contacts

To add a call list item to the contacts, do the following:

- 1) Press  and select the number you wish to add.
- 2) Press soft key **more...**, select **Add to Contacts** and press **Select**.
A dialog box appears with the fields *Number*, *Name*, and *Ring Signal*.
- 3) Edit the information in the *Number* and *Name* fields. Switch between the fields with the navigation keys.
- 4) If you want to, you can change the ring signal. Navigate to the *Ring Signal* field and press **Change**.



For information on how to change the ring signal, see 12.3.3 Changing Ring Signals For a Contact on page 78.

- 5) Press **Done** when you are done editing the contact fields. The new contact is saved.
- 6) Press  to return to the idle screen.

11.2.2

Adding a Call List Item To the Shortcuts

To add a call list item to the shortcuts, do the following:

- 1) Press  and select the number you wish to add.
- 2) Press soft key **more...**, select **Add to Shortcuts** and press **Select**.
The message "Select a Shortcut by pressing the key!" is displayed.
- 3) Press a shortcut key that is not already programmed.
A dialog box appears with the fields *Number*, and *Name*.
- 4) Edit the information in the *Number* and *Name* fields, if you wish.
Switch between the fields with the navigation keys.
- 5) Press **Done** when you are done editing the fields. The new shortcut is saved.
- 6) Press  to return to the idle screen.

11.3

Delete a Call List Item

You can delete one or all items from the call list.

11.3.1

Deleting One Call List Item

To delete one item from the call list, do the following:

- 1) Press  and select the item you wish to delete.
- 2) Press soft key **Delete**.
The message "[*number*] Delete?" is displayed.
- 3) Press **Yes** to confirm.

11.3.2

Deleting All Call List Items

To delete all items from the call list, do the following:

- 1) Press  and select **more...**

- 2) Select **Delete all calls in list** and press **Select**.

The message “Delete all calls in list?” is displayed.

- 3) Press **Yes** to confirm deletion. The message “No calls in CallList!” is displayed

Press **Exit** or  to return to the idle screen.

12 Contacts

This chapter describes how to manage contacts.

From the contacts menu,  you can call, add, edit, and remove contacts.

- For information on how to copy corporate directory contacts to your personal contacts, see 12.5 Corporate Directory on page 79.
- For information on how to copy Microsoft® Outlook® contacts to your personal contacts, see 12.6 Microsoft® Outlook® Contacts on page 80.

Note: The phone can hold up to 1,000 contacts.

12.1 Dial a Contact

There are two ways to open the contact list to make a call to a contact; either by pressing and holding the first letter of the contact name, or by opening the contact list and finding the desired contact.

To dial a contact from the contact list, do the following:

1. Press and hold the numeric key (2-9) with the initial letter of the name of the contact you wish to call.

OR

Press  to open the contact list.

2. Navigate to the desired contact and press **Call**.

12.1.1 Specifying a Search

To search a contact from the *idle screen*, do the following:

- To find all contacts beginning with the letters A, B, or C, press and hold the numeric key 2. To find all contacts beginning with the letters D, E, or F, press and hold the numeric key 3, and so on.

Note: When you hold and press a numeric key, the contacts list opens, and from here you can specify your search, see below.

To search a contact from the *contacts list*, do the following:

- To find all contacts beginning with letter A, press 2 once, and to find all contacts beginning with letter B, press 2 twice, and so on.

- To find a contact beginning with “Ab”, hold and press 2 once to display the letter A. Then press 2 twice in a row to display the letter B after A.

12.2 Add a Contact

There are several ways to add a contact:

- Add a contact by entering name and number. See 12.2.1 Adding a New Contact Manually on page 75
- Add a contact from the call list. See 11.2.1 Adding a Call List Item To the Contacts on page 71
- Add a contact from the corporate directory. See 12.5.2 Adding a Contact From the Corporate Directory on page 79.
- Add a contact from the web interface. See 19.1.1 Contacts Folder on page 117.

12.2.1 Adding a New Contact Manually

To add a new contact manually, do the following:

1. Press  and press **Add**.

A dialog box appears with the fields *Number*, *Name* and *Ring Signal*.

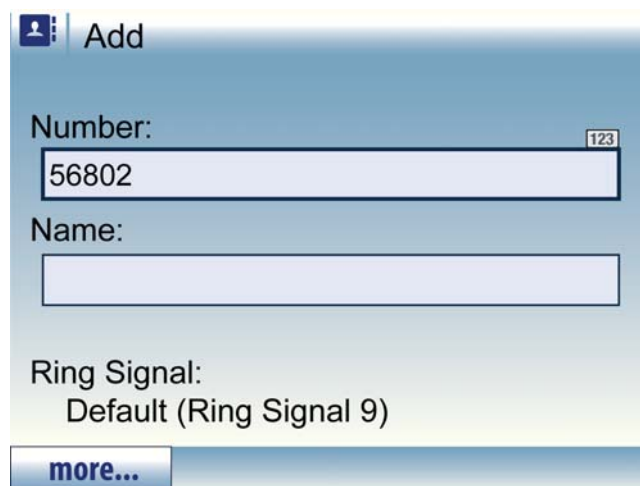

The screenshot shows a dialog box titled "Add" with a person icon. It contains the following fields and options:

- Number:** A text input field containing "56802" and a small "123" indicator.
- Name:** An empty text input field.
- Ring Signal:** A dropdown menu currently showing "Default (Ring Signal 9)".
- more...** A button at the bottom left.

2. Fill out the *Number* and *Name* fields manually. Switch between the fields with the navigation keys.
3. To modify the ring signal, navigate to the *Ring Signal* field and press **Change**.

For instructions on how to change the ring signal, see 12.3.3 Changing Ring Signals For a Contact on page 78.

4. Press **Done** when you are done editing the contact fields. The new contact is saved.
5. Press  to return to the idle screen.

Note: The digits can be stored by adding the country code number after a plus sign, for example +46 8 719 0000.

12.2.2

Adding a New Contact From the Call List

To add a new contact from the call list, do the following:

1. Press  and press **Add**.
A dialog box appears with the fields *Number*, *Name* and *Ring Signal*.
2. Press **more...**, select **Add new from Call List** and press **Select**.
3. Select a call list item and press **Add** again. The call list item appears with name and number in the display.
4. To modify the ring signal, navigate to the *Ring Signal* field and press **Change**.

For instructions on how to change the ring signal, see 12.3.3 Changing Ring Signals For a Contact on page 78.

5. Press **Done** when you are done editing the contact fields. The new contact is saved.
6. Press  to return to the idle screen.

Note: The digits can be stored by adding the country code number after a plus sign, for example +46 8 719 0000.

12.3

Edit a Contact

This section describes how to edit the contact details in the contact list.

Note: It is possible to edit contacts via the web interface, see 19.1.1 Contacts Folder on page 117.

12.3.1

Entering Information

- Enter text or numbers in fields by multi-tapping the dialing keys 2-9. The most common letters are printed above each dialing key on the phone.

Example: To enter the letter A in a field, press 2 once. To enter the letter B, press 2 twice. To enter the letter D, press 3 once. And so on.

By default, the first character you enter is written in upper case, and the rest of the word is written in lower case. Every new word starts with an upper case character (that is, after an entered space).

Switch between upper and lower case by pressing the star key *.

- Edit text or numbers in fields by deleting one character at a time, or a whole row at once:

Press **Erase** to delete the last character.

Press **Erase all** to clear the whole row.

- To change the default alphabet, change character sets via the My Settings menu. See 18.5 Language on page 111.

12.3.2

Editing a Contact

To edit a contact, do the following:

1. Press  and select the entry you wish to edit.
2. Press **Edit**.

A dialog box appears with the fields *Number*, *Name* and *Ring Signal*.

3. Edit the *Number* and *Name* fields. Switch between the fields with the navigation keys.
4. To modify the ring signal, navigate to the *Ring Signal* field and press **Change**.

For information on how to change the ring signal, see 12.3.3 Changing Ring Signals For a Contact on page 78.

5. Press **Done** when you are done editing the contact fields. The new contact is saved.
6. Press  to return to the idle screen.

12.3.3 Changing Ring Signals For a Contact

To change ring signals for a certain contact, do the following:

1. Press  and select the entry you wish to edit
2. Press **Edit**. A dialog box appears with the fields *Number*, *Name* and *Ring Signal*.
3. Navigate to the *Ring Signal* field and press **Change**.
4. Navigate to the ring signal or melody you wish to use and press **Select**.

Note: If you wish to listen to a signal or melody before selecting it, press **Play**. When you are done listening to a signal, press **Stop**.

12.4 Delete a Contact

It is possible to delete a selected contact, or all contacts at once.



12.4.1 Deleting One Contact

To delete a contact in the contact list, do the following:

1. Press  and select the number you wish to delete.
2. Press **more...**, select **Delete** and press **Select**.
The message “[*contact*] Delete?” appears.
3. Press **Yes** to confirm or **No** to cancel.

12.4.2 Deleting All Contacts

To delete all contacts in the contact list, do the following:

- 1) Press  and select **more...**
- 2) Select **Delete all contacts** and press **Select**.
The message “Delete all contacts?” is displayed.
- 3) Press **Yes** to confirm deletion. The message “Contacts empty!” is displayed.
Press **Exit** or  to return to the idle screen.



12.5 Corporate Directory

The corporate directory, which holds all contacts in your organization, resides on a corporate directory server.

When you search a contact in the corporate directory, a request is sent to the corporate directory server, which returns a list of names that matches the search. You can then choose to view the contact details, to call the contact, or to add it to your personal contacts.

12.5.1 Searching a Contact In the Corporate Directory

To call a contact in the corporate directory, do the following:

1. Press  and then press the shortcut key .

A dialog box appears with the fields *Number or Phone* and *Organization*.

2. Enter the name or number you wish to search and press **Search**.

To search a name, enter the *last name* first, then the *first name*, adding a space between the last and first names.

Example: To search for all persons with a last name starting with B and a first name starting with S, enter “b s”.

To search only a first name, add a space before the name.

Example: To search for all contacts with the first name of Susan, enter a space followed by the name, that is, “Susan”. All contacts called *Susan* are displayed, as are all contacts called *Susanne*.

3. When the search result is displayed, you can select a contact to **Call**, or **Add** to the personal contacts, or you can view the **Details** of the selected contact.



Note: If the search results in one contact only, that contact’s details are displayed.

For more information about adding a contact, see 12.5.2 Adding a Contact From the Corporate Directory on page 79.

4. To make a new search, press **more...**, select **New Search** and press **Select**.

12.5.2 Adding a Contact From the Corporate Directory

To add a contact from the corporate directory, do the following:

1. Press  and then press the shortcut key .

A dialog box appears with the fields *Number or Phone* and *Organization*.

2. Enter the name or number you wish to search and press **Search**.
The search result is displayed.

3. Select the contact you wish to add to your phonebook and press **Add**.

The name and number appear in their respective fields.

4. To modify the ring signal, navigate to the *Ring Signal* field and press **Change**.

For instructions on how to change the ring signal, see 12.3.3 Changing Ring Signals For a Contact on page 78.

5. Press **Done** when you are done editing the contact fields. The new contact is saved.

6. Press  to return to the idle screen.

Note: The digits can be stored by adding the country code number after a plus sign, for example +46 8 719 0000.

12.6

Microsoft® Outlook® Contacts

You can copy your Microsoft® Outlook® Contacts to the contact list in your phone. These numbers will be available in your phone in the same way as they are stored in Microsoft® Outlook® Contacts.

Before you can copy Microsoft® Outlook® Contacts, you need to install the My Dialog Contacts application on your PC. Contact the system administrator to obtain a link to the installation page.

Note: Store all phone numbers in Microsoft Outlook with area and country code, including the international + sign.

12.6.1

Installing My Dialog Contacts

To install the My Dialog Contacts on your PC, do the following:

1. Make sure you have the necessary information at hand when you start the installation.
2. Click the link **Install My Dialog Contacts now**.
3. Follow the instructions on screen to complete the installation.

When the installation is complete, the My Dialog Contacts icon appears on the desktop.

12.6.2

Adding My Dialog Contacts To the Contact List

To add My Dialog Contacts to your contact list, do the following:

1. Start the **My Dialog Contacts** application by clicking its icon.
2. Enter your phone number, phone password, and the IP address to the phone.

Note: You find the phone IP address by clicking , and selecting **Help, About Aastra 7444ip, Phone IP Address**.

3. Click **OK**.

All available Microsoft Outlook contacts are listed on the left side and the contacts that are already in your phone are listed on the right side.

4. Select the desired contacts on the left hand side and click **Add >>**.

Selected Microsoft Outlook contacts are moved to the contacts list in your phone.

5. Click **Save**.

The contacts are now available under  in your phone.

13 Presence Information

This chapter describes different availability settings available, and how you select them.

Presence information is used to inform callers when you are out of the office, and when you expect to return.

Available absence reasons are, for example, *Lunch*, *Busy*, *Vacation*, *Meeting* and *Trip*. Callers are informed by the operator of your whereabouts. For some of the absence reasons, you are prompted to specify the return time.

Note: The absence reasons listed above are examples of default reasons in the system. These can differ from the reasons programmed in the system you use.

When you have selected an absence reason, the display will show the reason along with any information of return date or time. The Follow-me key is lit.

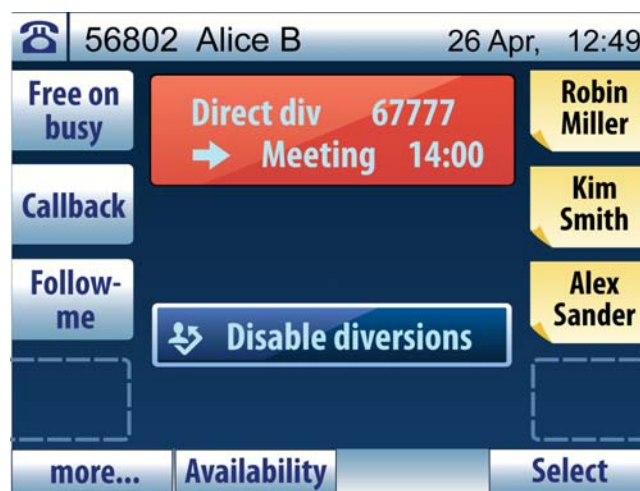

Note: When you have selected an absence reason, your phone can still be used for outgoing calls. As a reminder, you will hear a special dial tone when you lift the handset.

13.1 Selecting an Absence Reason

To change the presence status, do the following:

1. Press the soft key **Availability**.
2. Select **My Presence**, and press **Select**.

A list of absence reasons is displayed. Scroll the list with the navigation keys.

3. Select an absence reason and press **Select**.

The name of the selected absence reason is displayed. Depending on the reason selected, the field *Return time (HH:TT)* or *Return date (MM.DD)* may also appear below the reason.

4. If required, enter the expected return time or return date.
5. Press **Set** to send the absence information to the exchange.

13.2 Canceling Absence

13.2.1 Canceling An Absence Reason

To cancel an absence reason, do the following:

1. Press the soft key **Availability**.
2. Select **My Presence**, and press **Select**.
3. Select **Available**, and press **Select**.

13.2.2 Canceling All Diversions

To cancel all diversions, including call forwarding, do the following:

- Press the Follow-me key.

OR

- Select **Disable diversions** in the idle list and press **Select**.

14 Shortcuts

This section describes how to call, add, edit, and delete shortcuts from the Shortcuts pages.

Note: You can also add, edit, and delete shortcuts from the Settings menu, see 18.2 Shortcuts on page 108.

14.1 Shortcut Keys

The phone has 8 programmable shortcut keys, allowing you to program up to 80 shortcuts on 10 pages, with 8 shortcuts on each page.

When you press the shortcuts key, , page 2 of 10 is displayed. Press **Previous** and **Next** to switch pages. (Page 1 displays the same shortcuts as in idle mode.)

If you have a DPU/KPU installed, shortcut pages 2-4 in the phone will be used by the DPU/KPU, and if you have a second DPU/KPU installed, shortcut pages 5-7 will be used by that DPU/KPU, and so on.

Note: If you have three KPUs installed (the maximum number), each shortcut will have its own key.

14.2 Dial by Shortcuts

Shortcut keys can hold both features and phone numbers.

- To enable a function or dial a number programmed as a shortcut, press the key associated with the shortcut.

Note: If the shortcut is not visible in idle mode, press  to open the shortcuts menu and scroll to the page containing the desired shortcut and press its key.

14.3 Add a Shortcut

To add a shortcut, you can either enter the details manually, or retrieve them from the call list or the contacts list. This section describes how to do it.

14.3.1 Adding New Shortcut Manually

To add a shortcut manually, do the following:

1. Press  and press a shortcut key that is not programmed.

OR

Press an unprogrammed shortcut key.

The message “Not programmed! Program shortcut?” is displayed. The shortcut key indicator starts flashing slowly.

2. Press **Yes** to program the shortcut.
3. Enter a phone number in the *Number* field and a name in the *Name* field. Switch between the fields by pressing the navigation keys.

The number can be an extension number or an external number preceded by an external access code.

Note: If you wish the programmed number to be the shortcut label rather than a name you enter, press **Done** after entering the number.

4. Press **Done** to save the shortcut. The new shortcut appears in the display immediately.

14.3.2 Adding New Shortcut From Call List

To add a shortcut from the call list, do the following:

1. Press  and press a shortcut key that is not programmed.

OR

Press an unprogrammed shortcut key.

The message “Not programmed! Program shortcut?” is displayed. The shortcut key indicator starts flashing slowly.

2. Press **Yes** to program the shortcut.
3. Press **more...**, select **Add new from Call List** and press **Select**.
4. Select an entry in the call list that you wish to add as shortcut and press **Add**.
5. Press **Done** to save the shortcut. The new shortcut appears in the display immediately.

Note: You can edit the details before pressing **Done**.

14.3.3

Adding New Shortcut From Contacts

To add a shortcut from your contacts list, do the following:

1. Press  and press a shortcut key that is not programmed.
OR
Press an unprogrammed shortcut key.
The message "Not programmed! Program shortcut?" is displayed. The shortcut key indicator starts flashing slowly.
2. Press **Yes** to program the shortcut.
3. Press **more...**, select **Add new from Contacts** and press **Select**.
4. Select an entry in the call list that you wish to add as a shortcut and press **Add**.
5. Press **Done** to save the shortcut. The new shortcut appears in the display immediately.

Note: You can edit the details before pressing **Done**.

14.4

Edit a Shortcut

To edit a shortcut you can either go through the Shortcuts menu, or via the shortcut directly. See below.

14.4.1

Editing a Shortcut

To edit a shortcut, do the following:

1. Press . The second shortcut page opens.
2. Press **more...**, select **Edit Shortcuts** and press **Select**.
3. Press the shortcut that you wish to edit.

The Edit window appears for the selected shortcut. The shortcut key indicator starts flashing slowly.

4. Make the changes you want and press **Done**.

OR

1. Press and hold the shortcut key that you wish to edit.
The Edit window appears for the selected shortcut. The shortcut key indicator starts flashing slowly.
2. Make the changes you want and press **Done**.

14.4.2 Editing an MNS Key

MNS keys can only be programmed by the system administrator, but you can change the alert signal and the shortcut label.

To edit an MNS key, do the following:

1. Press . The second shortcut page opens.
2. Press **more...**, select **Edit Shortcuts** and press **Select**.
3. Press the shortcut that you wish to edit.

The Edit window appears for the selected shortcut. The shortcut key indicator starts flashing slowly.

4. To change the shortcut label, edit the label text and press **Done**.
5. To change the alert signal, press **more...**, select **Edit Alert** and press **Select**.

OR

1. Press and hold the shortcut that you wish to edit.

The Edit window appears for the selected shortcut. The shortcut key indicator starts flashing slowly.

2. To change the shortcut label, edit the label text and press **Done**.
3. To change the alert signal, press **more...**, select **Edit Alert** and press **Select**.

Note: For information about alert signals and how to select one, see 18.3.2 Alert Signal on page 109.

14.5 Delete a Shortcut

It is possible to delete one, several or all shortcuts at once. This section describes how to do it.

14.5.1 Deleting a Single Shortcut

To delete a single shortcut, do the following:

1. Press . The second shortcut page opens.
2. Press **more...**, select **Edit Shortcuts** and press **Select**.
3. Press the shortcut that you wish to delete.

The Edit window appears for the selected shortcut. The shortcut key indicator starts flashing slowly.

4. Press **more...** and select **Delete?** and press **Select**.
The message “[*shortcut name or number*] Delete?” is displayed.
5. Press **Yes** to confirm deletion.
If you press **No** you are returned to the previous window.

OR

1. Press and hold the shortcut key that you wish to delete.
The Edit window appears for the selected shortcut. The shortcut key indicator starts flashing slowly.
2. Press **more...** and select **Delete?**, and press **Select**.
The message “[*shortcut name or number*] Delete?” is displayed.
3. Press **Yes** to confirm deletion.
If you press **No** you are returned to the previous window.

14.5.2**Deleting Several Shortcuts**

To delete several shortcut, do the following:

1. Press . The second shortcut page opens.
2. Press **more...**, select **Edit Shortcuts** and press **Select**.
3. Press **more...**, select **Delete all Shortcuts** and press **Select**.
The message “Delete Shortcuts?” is displayed. The key indicators of all programmed shortcuts starts flashing slowly.
4. Press the shortcut keys that you wish to keep. The key indicators of the shortcuts that you deselect are turned off.
Press soft keys **Next** and **Previous** to switch between the shortcut pages.
5. Press **Yes** to confirm deletion.
If you press **No**, you are returned to the previous window.

14.5.3**Deleting All Shortcuts**

To delete all shortcut, do the following:

1. Press . The second shortcut page opens.
2. Press **more...**, select **Edit Shortcuts** and press **Select**.
3. Press **more...**, select **Delete all Shortcuts** and press **Select**.

The message “Delete Shortcuts?” is displayed. The key indicators of all programmed shortcuts starts flashing slowly.

4. Press **Yes** to confirm deletion.

If you press **No**, you are returned to the previous window.

15 Messages

When you have new messages waiting, the message icon appears in the display, and the indicator on the messages key  flashes.

If you receive a message during a call, you are notified with a beep. The messages key indicator keeps flashing until you press the key.

15.1 Voice Mail

A voice mail application allows you to record an absence message that callers will hear when you are unable to answer their calls. The callers can then leave messages in your mailbox.

Contact the system administrator for more information about the voice mail application and the mailbox configuration.

Note: If you use the personal number feature, you are recommended to program voice mail as the last answering position for all search profiles. See 10.3 Personal Number and Profiles on page 66 for more information.

15.1.1 Listening to VoiceMail Messages

Note: To be able to listen to voicemail messages, you have to program the voice mail number. See 15.1.3 Programming VoiceMail and My Messages Numbers on page 91.

To check and listen to received voice mails, do the following:

1. Press and hold **1**.
2. Follow the recorded instructions.

OR

1. Press .
2. Select **My VoiceMail**, and press **Call**.
3. Follow the recorded instructions.

15.1.2 Managing VoiceMail

When you call your VoiceMail you will receive voice instructions on how to listen to, record, store and delete messages, and change the security code.

To enter the voicemail, do the following:

1. Press .
2. Select **My VoiceMail**, and press **Call**.
3. Follow the recorded instructions.

15.1.3 Programming VoiceMail and My Messages Numbers

To program a number for **My VoiceMail** and/or **My Messages**, do the following:

1. Press  and **Settings**.
2. Enter your voicemail number and/or message server number.

If your extension can be connected to an additional message server, you can program a message server number.

Note: If you do not know the number to your voicemail or the message server, contact the system administrator.

3. Press **Done** to confirm.

15.2 Manual Message Waiting (MMW)

The Manual Message Waiting (MMW) feature enables you to send and receive message waiting signals.



MMW allows you to send a message waiting signal to an extension that does not answer when you call.

Note: The feature is enabled by the system administrator.

15.2.1 Calling the Party That Requested MMW

When you have new messages, the messages icon appears in the display, and the messages key indicator flashes.



To check who left the MMW, and to call this person, do the following:

1. Press .
Select . [*number or contact that left MMW*].
2. Press **Call**.

The person who left the MMW is called.

After the call, the messages icon still appears in the display, and you have to remove the MMW indication manually.

To remove an MMW indication manually, do the following:

1. Press .
Select . [*number or contact that left MMW*].
2. Press **Delete**.
The message “Delete [*number or contact that left MMW*]?” is displayed.
3. Press **Yes** to confirm deletion.
4. Press **Exit** to return to the idle list.

15.2.2

Ordering an MMW Indication

To order MMW to another extension, do the following:

- 1) Lift the handset and wait for a dial tone.
- 2) Dial *31* *extension number* #.
- 3) Replace the handset.

15.2.3

Canceling an MMW Indication

To cancel a MMW indication that you have sent to another extension, do the following:

- 1) Lift the handset and wait for a dial tone.
- 2) Dial #31* *extension number* #.
- 3) Replace the handset.

16 Group Features

This chapter describes group features, that make use of common group numbers in order to make it easier for others to reach you and your colleagues, and allow you to answer each other's calls.

Group Call Pickup

Group Call Pickup enables you to answer calls to you colleagues' extensions. That way, no calls will be missed.

Internal Group Hunting

Internal Group Hunting enables others to call a common number when they want to reach a member of your department, that is, your hunt group.

Group Do Not Disturb

Group Do Not Disturb is a feature where it is possible to activate do not disturb for all the members in the group.

16.1 Group Call Pickup

A call pickup group consists of a number of extensions (members) that have been assigned a *common group number*.

A member of a call pickup group can answer calls to any other member in the same group by dialing a procedure on their telephone and pick up the call. If there are several calls waiting to be answered, the oldest call in the queue will be picked up first.

Note: A call pickup group is set up and activated by the system administrator.

It is possible to preprogram group call pickup shortcuts, see 14.3 Add a Shortcut on page 84.

16.1.1 Main and Alternative Groups

A call pickup group can be affiliated as an *alternative answer group* to another group, which then becomes the *main group*.

If a member of the main group dials the procedure for call pickup but no calls are queued for the member's own group, a call will be picked up from the queue to an affiliated group.

It is only possible to pick up calls to an affiliated group if there are no calls waiting to be picked up in your own group. Up to four alternative answer groups can be affiliated to one main group.

16.1.2 Picking Up a Call

If you are a member of a call pickup group, you can answer calls to any other member (extension) in the group.

To answer a call to a call pickup group, do the following:

- 1) Lift the handset and wait for a dial tone.
- 2) Press *8# to answer the call.

16.2 Internal Group Hunting

An internal group hunting group consists of a number of extensions (members) that have been assigned a *common call number*.

When a common call number is called, the call is sent to an available group member (extension) according to a priority list. Only the selected extension will receive a notification of the call.

- If all extensions within the group are busy, the call will be queued.

Note: An internal hunt group is set up and activated by the system administrator.

16.2.1 Leaving a Group Temporarily

You can leave an internal group hunting group temporarily. To do that you have to order Follow-me to your own extension number, see 10.1.1 Ordering Follow-me From Own Telephone on page 61.

16.2.2 Reentering the Group

You can reenter an internal group hunting group that you have left temporarily. To do that you have to cancel Follow-me to your own extension number, see 10.1.2 Canceling Follow-me From Your Own Telephone on page 62.

16.3 Call Park Pool

You can park a call and transfer the call to a specific directory number (also called Call Park Pool) and any extension can pick up the call. If the call is not picked up within a few minutes, the call will recall your extension.

Transfer the call to the call park pool:

- You have an active call
- Press line 2 to put the call on hold and dial the number to the call park pool.
- Note the number (here called B-number) that shows up on the display.
- Press the **Transfer** softkey. Inform the person that shall take the call that he/she shall pickup the call on the B-number.

Pick up a call that is parked in the call park pool:

- Dial the B-number that you received from your colleague.
- When you hear the busy tone, press the **CallPickUp** softkey to pick up the call.

16.4 Group Do Not Disturb

A number of extensions can be defined as a *do not disturb* group. A categorized extension can activate *do not disturb* for the whole group. The calls will be forwarded to an answering position defined for the whole group or the calling party receives a number unobtainable tone.

An extension with *group do not disturb* activated can still make outgoing calls as usual.

16.4.1 To Order Group Do Not Disturb

A categorized extension can activate *group do not disturb* by dialling the following procedure:

- Lift the handset (dial tone)
- Dial *25*group number# (special dial tone)
- Replace the handset

16.4.2 To Cancel Group Do Not Disturb

A categorized extension can deactivate *group do not disturb* by dialling the following procedure:

- Lift the handset (dial tone)
- Dial #25*group number# (special dial tone)
- Replace the handset

16.4.3

Bypass of Group Do Not Disturb

A categorized extension or a PBX operator can bypass *group do not disturb* by dialling the following procedure:

- Lift the handset (dial tone)
- Dial *60*extension number#

The call is indicated on the telephone with the dialed extension number.

17 Advanced Features

This chapter describes advanced features such as *Account code*, *Authorization code*, *Personal number*, and *Alarm Extension*.

17.1 Account Code

Account codes allows you to keep track of where different outgoing calls are charged. The account code feature enables you to do the following:

- Have calls charged to a specified account, representing a particular project, department or client, rather than to the calling extension number.
- Prevent unauthorized calls to external numbers by requiring the extensions to dial an account code before dialing an external number.

Note: An account code can be entered either before or during an outgoing call. The code can be between 1 and 15 digits long.

17.1.1 Dialing an Account Code Before a Call

To dial the account code before dialing the destination number, do the following:

- 1) Lift the handset and dial *61* *account code #*.

Wait for a dial tone.

Note: Finland and Norway, dial *71* *account code #*.

- 2) Dial the external number.

17.1.2 Dialing an Account Code During a Call

To dial the account code during an ongoing call, do the following:

1. Press **Hold** and dial *61* *account code #*.

Wait for a dial tone.

Note: Finland and Norway, dial *71* *account code #*.

2. Press the line key for the line you wish to retrieve

Note: If you have several calls on hold, press **more...**, select **Retrieve** [*call on hold*], and press **Select**.

17.2 Authorization Code

Authorization codes are used to control or limit the access to an extension.

When an extension is controlled by an authorization code, certain service profiles are not allowed to use certain features, such as making calls to other countries. If you dial the authorization code, you open up the extension to use more features.

There are two kinds of authorization codes:

- Common Authorization Code. A common authorization code can be dialed from any extension.
- Individual Authorization Code. An individual authorization code is always associated with a specific extension.

Note: An authorization code must be entered before a call. The code is between 1 and 7 digits long.

17.2.1 Common Authorization Code

Depending on the *service profile* associated with your extension, you may have to enter a common authorization code in order to make certain types of calls, and to lock and unlock the extension.

Note: The common authorization code can only be changed by the system administrator.

The common authorization code provides the following functions:

- Locking and unlocking of an extension. A locked extension uses a low service profile.
- Authorization code dialing. The calling party may use other service profiles than those specified for the extension.

17.2.1.1 Dialing From An Extension

To make a call from an extension with a common authorization code, do the following:

1. Dial **72* authorization code #*.

Wait for a verification tone. If the code is not verified, the default common service profile will be used.

2. Dial the external number.
- If the service profile for the dialed authorization code is too low for the call, the call is rejected.

17.2.1.2 Locking an Extension

To lock an extension with a common authorization code, do the following:

- Dial *73* *authorization code #*.

When you hear a verification tone and the lock icon appears in the display, the extension is locked.

If you wish to make a call from a locked phone, different service profiles will be used depending on whether you enter an authorization code or not.

- When the telephone is locked, you have to dial *72* in order to acquire a higher level of service profile. If you do not enter an authorization code, the default service profile will be used.
- If you enter a valid authorization code, the service profile associated with the authorization code will be used.

17.2.1.3 Unlocking an Extension

To unlock an extension with a common authorization code, do the following:

- Dial #73* *authorization code #*.

When you hear a verification tone and the lock icon disappears from the display, the extension is unlocked.

Note: If the telephone is unlocked, you do not have to dial any authorization code.

17.2.2 Individual Authorization Code

If your extension has an *individual authorization code* associated with it, you can lock your own extension to a service profile when, for example, you are out of the office. Temporarily, you can also set the same authority level for any other extension within the exchange as for your own extension.

The individual authorization code provides the following functions:

- Locking and unlocking of an extension. A locked extension uses a low service profile.
- Authorization code dialing. The calling party may use other service profiles than those specified for the extension.
- Changing the authorization code from the phone. This enables the user of the authorization code to change the code when suitable.

17.2.2.1 Dialing From Own Extension

To make a authorization code call from your own extension with an individual authorization code, do the following:

1. Dial **75* authorization code #*.
Wait for a verification tone.
2. Dial the *external number*.

Note: If the service profile for the dialed external number is too low for the call, the call is rejected.

17.2.2.2 Dialing From Other Extension

To make a call from an extension with an individual authorization code (using another phone), do the following:

1. Dial **75* authorization code * own extension #*.
Wait for a verification tone.
2. Dial the *external number*.

Note: If the service profile for the dialed external number is too low for the call, the call is rejected.

17.2.2.3 Locking an Extension

To lock an extension with an individual authorization code, do the following:

- Dial **76* authorization code #*.
When you hear a verification tone and the lock icon appears in the display, the extension is locked.

17.2.2.4 Unlocking an Extension

To unlock an extension with an individual authorization code, do the following:

- Dial *#76* authorization code #*.
When you hear a verification tone and the lock icon disappears from the display, the extension is unlocked.

If you wish to make a call from a locked phone, different service profiles will be used depending on whether you enter an authorization code or not.

- If you do not enter an authorization code, the default service profile will be used.
- If you enter a valid authorization code, the service profile associated with the authorization code will be used.

17.2.2.5

Changing the Authorization Code

The individual authorization code can only be changed from your own phone.

To change the individual authorization code for an extension, do the following:

1. Dial **74* previous authorization code * new authorization code #*.
2. When you hear a verification tone, the individual authorization code has been changed.

Note: The authorization code will be changed only if the previous authorization code is valid.

17.3

Alarm Extension

An alarm extension is assigned characteristics similar to an alarm centre. All calls to such an extension are automatically granted intrusion access if the extension is busy. Up to seven callers can be connected to the alarm extension at the same time.

An alarm extension cannot be assigned to an IP phone, but it is possible to call an alarm extension from an IP phone.

17.4

Direct In-dialing

Direct In-dialing is a feature that enables direct routing of incoming external calls to predefined extensions or groups. Usually, the exchange has a direct in-dialing feature, enabling external subscribers to call you directly without having to go through the operator.

Note: A call that is not answered by a predefined extension can be rerouted to an operator or an alternate answering position.

17.5 General Deactivation

General deactivation enables you to cancel a number of features in one single command. The following features are canceled with the general deactivation feature:

- Callback (all callbacks are cancelled)
- Follow-me and External follow-me
- Manual Message Waiting
- Flexible night service

17.5.1 Ordering General Deactivation

To order a general deactivation, do the following:

- 1) Lift the handset and wait for a dial tone.
- 2) Dial #001#.
- 3) Replace the handset.

17.6 Night Service

When the telephony system is in *night service mode*, all incoming calls to the operator are transferred to a selected extension or group of extensions. Night service mode is used outside business hours.

There are three kinds of night services:

- **Common Night Service.** Common night service means that all incoming calls are routed to one designated extension. Calls are answered in the normal way.
- **Individual Night Service.** Individual night service means that one or more external lines in the exchange are routed to the designated extension. Calls are answered in the normal way.
- **Flexible Night Service.** Flexible night service means that the operator can reroute calls to a certain extension during restricted hours. For more information, see 17.6.1 Flexible Night Service on page 102.

17.6.1 Flexible Night Service

Flexible night service permits you to select an external line and connect it directly to your telephone. This is convenient when you expect impor-

tant calls after office hours and wish to get them without delay. Details about external line numbers can be obtained from the operator.

17.6.1.1 **Activating Flexible Night Service**

To activate flexible night service, do the following:

- 1) Lift the handset and wait for a dial tone.
- 2) Dial **84* route number * external line number #*.
- 3) Replace the handset.

17.6.1.2 **Deactivating Flexible Night Service**

To deactivate flexible night service, do the following:

- 1) Lift the handset and wait for a dial tone.
- 2) Dial *#84#*.
- 3) Replace the handset.

Note: The flexible night service is deactivated automatically one hour after the exchange has been switched back into day service (if the service has been active for at least one hour). This way you do not have to be concerned about forgetting to deactivate the flexible night service for your extension.

17.7 **Individual Do Not Disturb (DND)**

You can activate this feature when you want to avoid incoming calls to your telephone. The calling party receives a number unobtainable tone or a busy tone or will be forwarded to the diversion position if it is defined by the system administrator.

17.7.1 **To Order Do Not Disturb**

- 1) Lift the handset (dial tone).
- 2) Dial **27#*
- 3) Replace the handset.
- 4) A text in the display reminds you that DND is activated.

The telephone can still be used for outgoing calls as usual.

17.7.2 To Cancel Do Not Disturb

- 1) Lift the handset (special dial tone).
- 2) Dial #27#. Dial tone
- 3) Replace the handset.

17.8 Emergency State

In case of emergency, the operator is authorized to put the exchange into an emergency state. In such a situation, the exchange properties and rules as configured for emergency state prevail.

In emergency state, only extensions with the appropriate service profile will be permitted to initiate calls. If you have not been assigned this service profile and try to make a call, you will not receive a dial tone.

17.9 Malicious Call Tracing

If you are being disturbed by bothersome or malicious external incoming calls, it is possible to request number tracing from the network provider. Tracing can be invoked during or after a call.

When malicious call tracing (MCT) is enabled, a signal is sent to the switched telephone network (PSTN) before the malicious call is disconnected. If the calling subscriber clears the call, the external line can be held for a limited period of time to invoke MCT.

The MCT feature registers information about the origin of the call, that is, the number of the calling party, and date and time of the call.

Note: The MCT feature can be assign to a shortcut key by the system administrator.

17.9.1 Ordering Malicious Call Tracing

To order MCT during a call, press the MCT shortcut key.

Note: If no shortcut has been programmed, press **Hold** and dial *39#.

- If the request is accepted, the shortcut key indicator is lit, a text message is displayed, and an acceptance tone is heard.
- If the request is rejected, the shortcut key indicator flashes rapidly, a text message is displayed, and a reject tone is heard.

17.10 Direct Inward System Access (DISA)

Not applicable.

17.11 Monitoring Keys

A monitoring key (or MNS key) is a key that allows you to monitor and answer calls to other extensions, as well as make calls to the monitored extension.

Note: MNS keys are programmed as a shortcut keys by the system administrator.

The monitoring feature is especially useful in Boss-Secretary applications.

You answer a call to an monitored extension by pressing the shortcut key which the extension has been programmed to.

The shortcut displays one of the following status indications:

- **The indicator lamp is off:** The monitored extension is free.
- **The indicator lamp is flashing fast:** The monitored extension has an incoming call waiting to be answered.
- **The indicator lamp is on:** The monitored extension is busy.
- **The indicator lamp is flashing slowly:** The monitored extension is put on hold.

Note: When you log on to another IP phone, all monitoring keys are moved automatically to the other telephone.

For information on how to edit a shortcut key, see 14.4.2 Editing an MNS Key on page 87.

18 Settings

This chapter describes how to change the phone settings from the My Settings menu which is invoked by pressing the settings key, .

Note: You can return to the idle menu at any time by pressing .

18.1 My Availability Settings

In the My Availability menu, it is possible to specify the following settings:

- My Presence
- Follow-me
- External Follow-me
- My Profile
- My mobile phone
- Free on busy

18.1.1 My Presence

Note: My Presence is described in detail in 13 Presence Information on page 82.

To change the presence status, do the following:

1. Press , select **My Availability**, and press **Select**.

OR

Press soft key **Availability**.

2. Select **My Presence**, and press **Select**.

A list of absence reasons is displayed. Scroll the list with the navigation keys.

3. Select an absence reason and press **Select**.

The name of the selected absence reason is displayed. Depending on the reason selected, the field *Return time (HH:TT)* or *Return date (MM.DD)* may also appear below the reason.

4. If required, enter the expected return time or return date.
5. Press **Set** to send the absence information to the exchange.

Note: To cancel an absence reason, press the lit Follow-me shortcut key or select “Disable diversions” in the idle list. The indicator lamp is turned off.

18.1.2 Follow-me

To order Follow-me, do the following:

1. Press .
2. Select **My Availability**, and press **Select**.
3. Select **Follow-me**, and press **Select**.
4. Enter the extension number and press **Done**.

18.1.3 External Follow-me

To order external Follow-me, do the following:

1. Press .
2. Select **My Availability**, and press **Select**.
3. Select **External Follow-me**, and press **Select**.
4. Enter the external access code + the external number and press **Done**.

18.1.4 My Profile

To select a profile, do the following:

1. Press .
2. Select **My Availability**, and press **Select**.
3. Select **My Profile**, and press **Select**.
4. Enter the profile number and press **Done**.

18.1.5 My Mobile Phone

To edit the specified mobile phone number, do the following:

1. Press .
2. Select **My Availability**, and press **Select**.
3. Select **My mobile phone**, and press **Select**.
4. Enter your mobile phone number in the field and press **Done**.

18.1.6 Free On Busy

To activate free on busy, do the following:

1. Press .
2. Select **My Availability**, and press **Select**.
3. Select **Free on busy:OFF**, and press **Select**.
4. Select **ON, put call through**, and press **Select**.

To disable Free on busy, select **OFF, send busy on busy**.

Note: You can enable and disable Free on busy by pressing the Free on busy shortcut key. The indicator lamp is turned on or off to indicate status.

18.2 Shortcuts

You can program, edit, and delete shortcuts via the Shortcuts option in the My Settings menu as well as via the Shortcuts menu.

- Press  and select **Shortcuts**. The message “Select a Shortcut by pressing the key!” is displayed. Press the shortcut key you wish to program, edit, or delete.

For step-by-step instructions on how to program, edit and delete shortcuts, see 14 Shortcuts on page 84.

18.3 Sounds

This section describes how to change ring signals and alert signals for incoming calls from the settings menu **Sounds**.

Note: You can change the ring signal for individual contacts, see 12.3.3 Changing Ring Signals For a Contact on page 78.

18.3.1 Changing Ring Signals for Incoming Calls

A ring signal can be either a traditional ring signal or a melody that you download from a server.

To change ring signals for all incoming calls, do the following:

1. Press .
2. Select **Sounds** and press **Select**.

3. Select **Ring Signals** and press **Select**.
Default Ring Signals is selected.
4. Press **Select**.
5. Navigate to the ring signal or melody you wish to use, and press **Select**.
Note: If you wish to listen to a signal or melody before selecting it, press **Play**. When you are done listening to a signal, press **Stop**.
6. Press **Yes** to confirm.
7. Press  to return to the idle state.

18.3.1.1

Downloading Melodies

Instead of standard ring signals, you can download up to 10 melodies to your phone.

To download a melody from a specified server, do the following:

1. Press .
2. Select **Sounds** and press **Select**.
3. Select **Ring Signals** and press **Select**.
Default Ring Signals is selected.
4. Press **Select**.
5. Navigate to **Melody 1 (empty)** and press **Add**.
A list of all available melodies is displayed.
6. Select a melody and press **Select**.

Note: If you wish to listen to a signal or melody before selecting it, press **Play**. When you are done listening to a signal, press **Stop**.

18.3.2

Alert Signal

The alert signal specifies how the selected ring signal will sound. You can set different alert signals for the first incoming call and the second incoming call. The following alert signals are available:

Visual only

The signal is muted, but the indicator on the line key where the call is received is flashing.

Periodic	The ring signal alerts periodically.
Delayed Periodic	There is a delay before the first ring signal. The length of the delay can be changed by the system administrator.
One Muted	The phone rings once, then the signal is muted.
Delayed One Muted	There is a delay before the ring signal. After one ring, the signal is muted. The length of the delay can be changed by the system administrator.

18.3.2.1

Setting the Alert Signal For Incoming Calls

To change the alert signal for incoming calls, do the following:

1. Press .
2. Select **Sounds** and press **Select**.
3. Select **Alert** and press **Select**.
4. Select **Alert 1st call** or **Alert 2nd and 3rd call**, and press **Select**.
5. Select an alert type, and press **Set**.

The available alert types are described above.

Note: If you wish to listen to an alert signal before selecting it, press **Play**. When you are done listening to a signal, press **Stop**.

18.4

Display

This section describes how to change the display brightness and how long the display will be illuminated, that is, the brightness hold time.

18.4.1

Setting the Brightness

To modify the brightness hold time, do the following:

1. Press .
2. Select **Display** and press **Select**.
Press **Select** again to open the *Phone Brightness* window.
3. Edit the **Intensity** and **Brightness Hold time** settings.

Press the plus (+) or minus (-) soft keys, or the volume keys, to increase or decrease the intensity and brightness hold time to the desired levels. Switch between the fields with the navigation keys.

4. Press **Set** for each setting.
5. Press  to return to the idle state.

18.5 Language

This section describes how to change language in the display menus, and character set for the keypad characters in your phone.

Note: There are several languages and character sets available for the phone. They are enabled by the system administrator.

18.5.1 Display Menus

To change the language in the display menus, do the following:

1. Press .
2. Scroll to **Language** and press **Select**.
3. Select **Display Menus** and press **Select**.
A list of available languages is displayed.
4. Scroll the list with the navigation keys and select the desired language.
5. Press **Set**.
A confirmation message is displayed.
6. Press **Yes** to confirm, or **No** to cancel.

Note: The phone must be registered to the exchange, and the desired language must be available in the exchange, otherwise it is not possible to change languages.

18.5.2 Keypad Characters

To change the keypad character set, do the following:

1. Press .
2. Scroll to **Language** and press **Select**.
3. Select **Keypad Characters** and press **Select**.

A list of available character sets are displayed.

4. Scroll the list with the navigation keys and select the desired character set.

Press **Set**.

A confirmation message is displayed.

5. Press **Yes** to confirm, or **No** to cancel.

18.6 Time and Date

This section describes how to change the time and date format in the phone display, and how to set the time and date manually.

18.6.1 Setting the Time Format

To set the time format, do the following:

1. Press .
2. Select **Time & Date** and press **Select**.
3. Select **Time Format** and press **Select**.
4. Select the **24 hour** or **12 hour** time format, and press **Select**.

18.6.2 Setting the Date Format

To set the date format, do the following:

1. Press .
2. Select **Time & Date** and press **Select**.
3. Select **Date Format** and press **Select**.
4. Scroll the list with the navigation keys and select the desired date format.
5. Press **Select**.

18.7 Option Unit (Optional)

Note: In section 4.4 Option Unit (Optional) on page 26, you will find the detailed information on the option unit and how you install it.

To modify the option unit settings, do the following:

1. Press .
2. Select **Option Unit**, and press **Select**.
Note: **Option Unit** is available only when an option unit is installed.
3. Select **Busy signal**, **Extra bell**, or **Combined Bell/Busy**, and press **Select**.

18.8 Security and Access

It is possible to view and change the PIN code, if this option has been configured by system administrator.

18.8.1 Changing PIN Code

You can change the PIN code used for logging on to the telephony system. The PIN is the same as the individual authorization code, see 17.2 Authorization Code on page 98.

Note: Depending on the phone configuration, the menu option **Changing PIN** may or may not be available.

To change the PIN code, do the following:

1. Press .
2. Select **Security and Access**, and press **Select**.
3. Select **Change PIN** and press **Select**.
4. Enter the new PIN and press **OK**.

18.9 Auto Answer

The Auto Answer option displays the current setting for the automatic answer feature, which is described in detail in 7.4 Automatic Answer on page 44.

Note: You can only view the current settings, not change them.

To view the automatic answer settings, do the following:

1. Press .
2. Scroll down to **Auto Answer** and press **Select**.

The current setting is displayed.

18.10

Help

You can easily get information on which software version is installed on your phone, the phone IP address, and the phone web address.

To find this information, do the following:

1. Press .
2. Scroll down the list, select **Help**, and press **Select**.
3. Select **About: Aastra 7444ip** and press **Select**.

The current software version is displayed, along with at least one option.

4. Select **Phone IP Address** and press **Select** to see the current IP address.

OR

Select **Phone Web Address** and press **Select** to see the current web address.

Whether or not the **Phone Web Address** option is available in the **Help** menu, depends on how the phone is configured. Contact the system administrator for more information.

19 Web Interface

This chapter describes how to change the phone settings from a web interface.

Note: To access the phone web interface, you need to know the phone web address or IP address, see 18.10 Help on page 114.

Using a web interface, you can change the following settings in your phone:

- **Contacts**
 - Add to contacts
 - Delete all contacts
- **Call list**
 - Delete call list
- **Settings**
 - Phone Shortcuts
 - Sounds
 - Security and Access

Note: If at least one KPU or DPU is attached to the phone, it is also possible to manage these shortcuts. Up to three panels can be visible under Phone Shortcuts; **Panel 1 Shortcuts**, **Panel 2 Shortcuts**, **Panel 3 Shortcuts**.

19.1 Using the Phone Through the Web

To use your phone through the web interface, do the following:

1. Enter the phone web address or IP address in the address field of your web browser.

To find out the web address or IP address of the phone, see 18.10 Help on page 114.

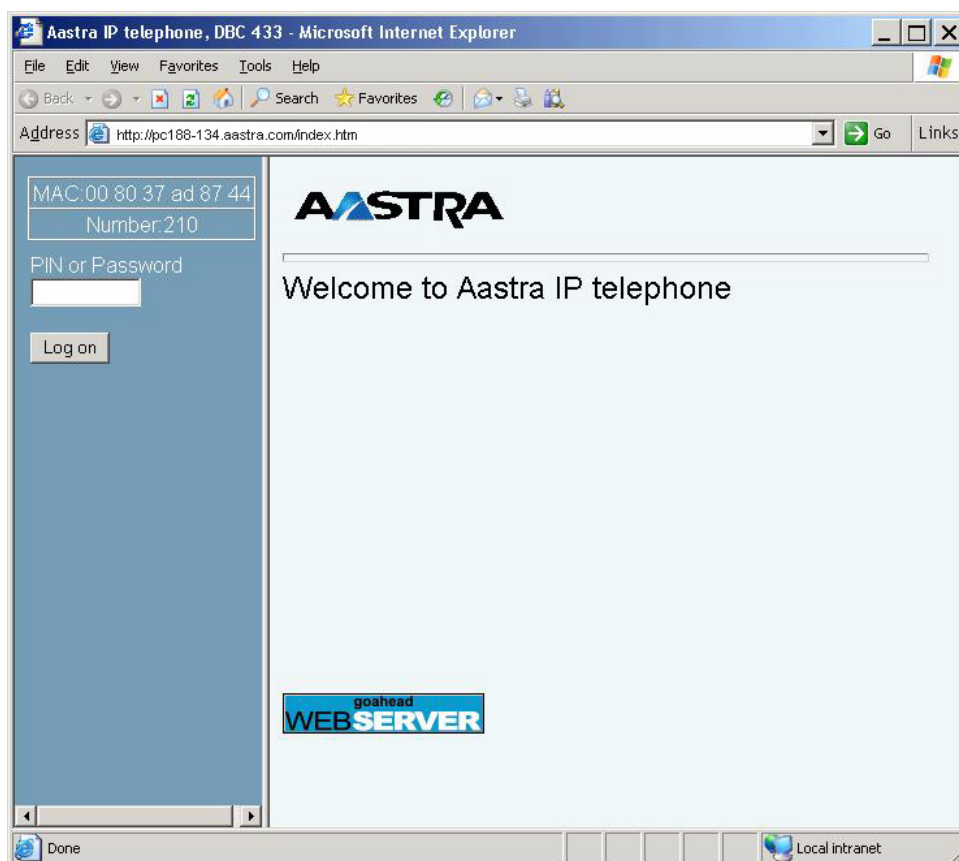

2. Enter your password (or PIN code) and click **Log on**.

Note: Use the same password (or PIN code) as you use to log on your phone. If you have no logon password (or PIN code), you cannot log on to the web interface, unless the system administrator has enabled the default password *Welcome*. If you have forgotten your password (or PIN code), contact the system administrator.

- Expand the folder(s) to start edit data.

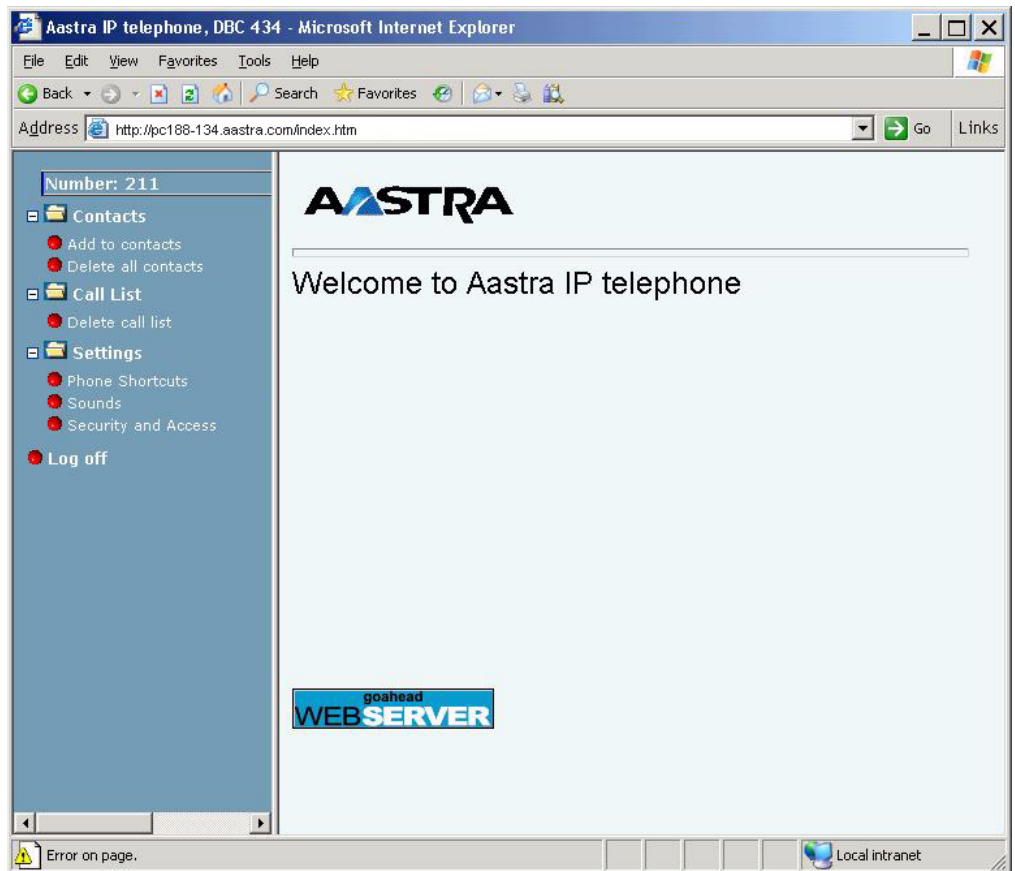

To exit the web interface of the phone, press **Log off**.

19.1.1 Contacts Folder

Click **Contacts** to see a list of the contacts stored in your phone. If you expand the **Contacts** folder, you can add and delete contacts.

19.1.1.1 Adding a Contact

To add a new contact, do the following:

- Expand **Contacts**.
- Click **Add to contacts**.
- Enter name and number.
- Select a ring signal.
- Click **Add to contacts**.

The new name and number are saved.

19.1.1.2 Editing or Deleting a Contact

To edit or delete a contact, do the following:

1. Click **Contacts**.
2. Click the name to edit or delete.
3. Do any of the following:
 - Make the changes and click **Save** to save.
 - Click **Delete** to delete the current contact.
 - Click **Back** to exit the edit and delete menu without any changes.

19.1.1.3 Deleting All Contacts

To delete all your contacts, do the following:

1. Expand **Contacts**.
2. Click **Delete contacts**.
A confirmation message is displayed.
3. Click **OK** to delete all names and numbers.

19.1.2 Call List Folder

Click **Call List** to see calls to and from your phone. From the web interface, it is possible to make a call to a number in the list and delete items from the list. It is also possible to add call list numbers to your contacts.

19.1.2.1 Adding, Calling, or Deleting a Call List Item

To delete, call, or add to contacts a call list item, do the following:

1. Click **Call List**.
2. Click a name (or -) from the *Name* field in the table.
3. Do any of the following:
 - Click **Add to contacts** to add the call list item. You can edit the name, number or ring signal before clicking **Add to contacts**.
 - Click **Delete** to delete the current call from the list.
 - Click **Call** to call the number.

- Click **Back** to exit the edit and delete menu without any changes.

19.1.2.2 Clearing the Call List

To delete all names and numbers from the call list, do the following:

1. Expand **Call List**.
2. Click **Delete call list**.
A confirmation message is displayed.
3. Click **OK** to delete the call list.

19.1.3 Settings - Shortcuts

1. Expand **Settings**.
The submenus are shown.
2. Click the submenu to be changed:
 - **Phone Shortcuts**.
 - **Panel 1 Shortcuts**
 - **Panel 2 Shortcuts**
 - **Panel 3 Shortcuts**

A table with the current programming for each key is shown. The table shown corresponds to how the keys are placed on the phone or on the panel unit.

Note: Text that is not underlined, means it is a fixed key and can only be changed by the system administrator.

19.1.3.1 Programming a Shortcut

To create a shortcut, do the following:

1. Select the key to be programmed.
2. Enter the number or code.
3. Click **Save**.

The key table is shown with the new number or code.

19.1.3.2 Editing a Shortcut

To edit a shortcut, do the following:

1. Click the underlined number or code for the key to be changed.
2. Select the characters to be changed.
3. Enter new characters.
4. Click **Save**.

The key table is shown with the edited number or code.

19.1.3.3 Deleting a Shortcut

To delete a shortcut, do the following:

1. Click the underlined number or code for the key to be deleted.
2. Click **Delete**.

The key table shows a “_” for that key.

19.1.4 Settings - Sounds

To change the hearing level settings, do the following:

1. Expand **Settings**.

The submenus are shown.

2. Click **Sounds**.

The current settings for **Default Ring Signal**, **Alert 1st Call**, and **Alert 2nd and 3rd Call** are displayed.

3. Make the desired changes by selecting values from the drop-down lists, and click **Save**.

19.1.5 Settings - Security and Access

To change the PIN code, do the following:

1. Expand **Settings**.
2. Click **Security and Access**.
3. Select **Change PIN**.

Enter phone number and old PIN code. Enter the new PIN code (the second time for confirmation).



4. Press **Apply**.

Note: before you can change the PIN code, the phone must be configured by the system administrator to use PIN code.

20

Troubleshooting

This chapter contains information on how to solve common operational problems, and warnings you may receive. Go through the following list if you encounter any problems. If this checklist does not cover the problem, contact the system administrator. If others have similar problems, there may be a system error.

Fault / Display	Probable cause	Action or comment
The phone is locked	Disturbance on the network.	Press    and # simultaneously for one or two seconds. This will restart the phone.
The access warning triangle appears in the display.	Disturbance on the network or in the telephony system.	Although some features may not work, the phone can be used for receiving and making calls. If the trouble persists, contact the system administrator.
No connection to network! (Message appears in the display)	There is no connection to the LAN.	Verify that the phone is connected to the network by checking the LAN cable between the LAN port and the phone.

21 Telephony Suffixes and Service Codes

Most features are activated by either a suffix or a service code. This chapter lists the most common suffixes and service codes available in MX-ONE.

Note: The Aastra 7444ip phone has dedicated keys for several of the features listed below.

- **Standard code.** The standard code is the default code that applies to all included markets.
- **Alternative code.** This column lists the markets that have chosen another code than the standard one for each feature. These are the markets concerned:
 - Australia and New Zealand
 - Europe: Austria, Belgium, Denmark, Finland, France, Germany, Ireland, Italy, The Netherlands, Norway, Spain, Sweden, Switzerland, and United Kingdom
 - Asia: China, Hong Kong A-law, Hong Kong My-law, Indonesia, Malaysia, Korea, Singapore,
 - America: Brazil, Mexico, North America (USA and Canada)
 - Africa: Saudi Arabia, South Africa.

21.1 Suffix Digits

Some features are initiated by a digit (a suffix).

Table 9 Suffixes: Standard and Alternative Codes

Feature	Standard Suffix	Alternative Suffix
Alternation on Inquiry	Line key	-
CallWaiting	5	France: 6 New Zealand: 6 Sweden: 4

Feature (Cont.)	Standard Suffix (Cont.)	Alternative Suffix (Cont.)
Callback	6	France: 5 New Zealand: 5 Sweden: 5
Common Hold	8	France: 4 New Zealand: 4 Sweden: 6
Individual Call Pick-up	8	France: 4 New Zealand: 4 Sweden: 6
Intrusion	4	France: 8 New Zealand: 8 Sweden: 8

21.2

Service Codes

Some features can be programmed, ordered, or cancelled by a procedure containing a service code using syntax according to the ETSI standard for telecommunication.

Example: * 21 * nnnn #.



Table 10 Service Codes: Standard and Alternative Codes

Feature	Standard Code	Alternative Code
ACCOUNT CODE	*61* account code #	Finland, Norway: *71* account code #
AUTHORIZATION CODE		
Common Authorization Code CAC:		
Increase common service profile (CSP)	*72* authorization code #	
Lock extension	*73* authorization code #	North America: *71* authorization code #

Feature (Cont.)	Standard Code (Cont.)	Alternative Code (Cont.)
Unlock extension	#73* authorization code #	North America: #71* authorization code #
Individual (Regional) Authorization Code, RAC:		
Dial with RAC	*75* authorization code #	Germany, The Netherlands, Sweden: *72* authorization code #
Lock extension	*76* authorization code #	
Unlock extension	#76* authorization code #	
Change RAC	*74* old code * new code #	
AUTOMATIC CALLBACK		
Order Callback		
Busy extension or no reply	Press key 6	
Busy external line	Press key 6	
Cancel Callback		
Busy extension or no reply	#37* extension number #	
Busy external line	#37* external number #	
All Callbacks	#37#	North America: #6#
BYPASS DIVERSION	*60* B-number #	North America: *1* B-number #
CALL PICKUP		

Feature (Cont.)	Standard Code (Cont.)	Alternative Code (Cont.)
Group call pickup	8	Finland: 0 North America: 59 Sweden: 0
CALL WAITING	*8#	
COMMON ABBREVIATED NUMBERS	See your company's list of common abbreviated numbers.	
CONFERENCE	Press soft key or shortcut key	
CUSTOMER IDENTITY STORAGE	77	
EXTERNAL FOLLOW-ME		
Order	*22# route access code and external number #	
Cancel	#22#	
Remote Programming of another extension		
Order	*22* extension number to divert # route access code and external number#	North America: *23* extension number to divert # route access code and external number#
Cancel	#22* diverted extension number #	North America: #23* diverted extension number #
FOLLOW-ME		
Order from own extension	*21* B-number #	United Kingdom: *2* B-number #
Cancel from own extension	#21#	United Kingdom: #2#

Feature (Cont.)	Standard Code (Cont.)	Alternative Code (Cont.)
Remote Programming of another extension		
Order	*21*extension number to divert * number of follow-me position#	
Cancel	#21*diverted extension number#	
Order new follow-me position	#21* A-number #	
Cancel from answering position	*21* A-number * C-number #	
GENERAL DEACTIVATION	#001#	North America: #0#
INQUIRY		
Initiate	Press line key	
Revert to original party	Press the line key where the original party is parked	
INTERCEPTION MESSAGE		
Print	26	Sweden: N/A
Order/Cancel	23	North America: 24
LANGUAGE SELECTION	08	
LAST EXTERNAL NUMBER REDIAL	***	Finland: **0 Sweden: **0
MALICIOUS CALL TRACING	39	

Feature (Cont.)	Standard Code (Cont.)	Alternative Code (Cont.)
MANUAL MESSAGE WAITING		
Order	*31* extension number #	
Cancel	#31#	
Reply	*32#	
NIGHT SERVICE		
Universal	8	Finland: 0 North America: 59 Sweden: 0
Flexible		
Order	*84* route number * external line number #	North America: *8* route number * external line number #
Cancel	#84#	
MANUAL MESSAGE WAITING		
Order	31	North America: 56
Cancel	31	North America: 56
NUMBER PRESENTATION RESTRICTION	*42# B-number	
PERSONAL NUMBER		
Activate	*10*profile#	
Deactivate	#10#	
RESTART	Press   and # simultaneously for at least one second.	

Feature (Cont.)	Standard Code (Cont.)	Alternative Code (Cont.)
SOFTWARE VERSION	Press  , select Help and About:Aastra 7444ip . The software version appears in the display.	
TRANSFER	Press soft key or shortcut key	