

# ir33 Universale

electronic control

# CAREL



**ENG** User manual

**LEGGI E CONSERVA  
QUESTE ISTRUZIONI**  
**READ AND SAVE  
THESE INSTRUCTIONS**

Integrated Control Solutions & Energy Savings

## WARNINGS



CAREL bases the development of its products on decades of experience in HVAC, on the continuous investments in technological innovations to products, procedures and strict quality processes with in-circuit and functional testing on 100% of its products, and on the most innovative production technology available on the market. CAREL and its subsidiaries nonetheless cannot guarantee that all the aspects of the product and the software included with the product respond to the requirements of the final application, despite the product being developed according to start-of-the-art techniques. The customer (manufacturer, developer or installer of the final equipment) accepts all liability and risk relating to the configuration of the product in order to reach the expected results in relation to the specific final installation and/or equipment. CAREL may, based on specific agreements, act as a consultant for the positive commissioning of the final unit/application, however in no case does it accept liability for the correct operation of the final equipment/system.

The CAREL product is a state-of-the-art product, whose operation is specified in the technical documentation supplied with the product or can be downloaded, even prior to purchase, from the website [www.carel.com](http://www.carel.com).

Each CAREL product, in relation to its advanced level of technology, requires setup / configuration / programming / commissioning to be able to operate in the best possible way for the specific application. The failure to complete such operations, which are required/indicated in the user manual, may cause the final product to malfunction; CAREL accepts no liability in such cases.

Only qualified personnel may install or carry out technical service on the product.

The customer must only use the product in the manner described in the documentation relating to the product.

In addition to observing any further warnings described in this manual, the following warnings must be heeded for all CAREL products:

- prevent the electronic circuits from getting wet. Rain, humidity and all types of liquids or condensate contain corrosive minerals that may damage the electronic circuits. In any case, the product should be used or stored in environments that comply with the temperature and humidity limits specified in the manual;
- do not install the device in particularly hot environments. Too high temperatures may reduce the life of electronic devices, damage them and deform or melt the plastic parts. In any case, the product should be used or stored in environments that comply with the temperature and humidity limits specified in the manual;
- do not attempt to open the device in any way other than described in the manual;
- do not drop, hit or shake the device, as the internal circuits and mechanisms may be irreparably damaged;
- do not use corrosive chemicals, solvents or aggressive detergents to clean the device;
- do not use the product for applications other than those specified in the technical manual.

All of the above suggestions likewise apply to the controllers, serial boards, programming keys or any other accessory in the CAREL product portfolio.

CAREL adopts a policy of continual development. Consequently, CAREL reserves the right to make changes and improvements to any product described in this document without prior warning.

The technical specifications shown in the manual may be changed without prior warning.

The liability of CAREL in relation to its products is specified in the CAREL general contract conditions, available on the website [www.carel.com](http://www.carel.com) and/or by specific agreements with customers; specifically, to the extent where allowed by applicable legislation, in no case will CAREL, its employees or subsidiaries be liable for any lost earnings or sales, losses of data and information, costs of replacement goods or services, damage to things or people, downtime or any direct, indirect, incidental, actual, punitive, exemplary, special or consequential damage of any kind whatsoever, whether contractual, extra-contractual or due to negligence, or any other liabilities deriving from the installation, use or impossibility to use the product, even if CAREL or its subsidiaries are warned of the possibility of such damage.

## WARNING:



separate as much as possible the probe and digital input signal cables from the cables carrying inductive loads and power cables to avoid possible electromagnetic disturbance.

Never run power cables (including the electrical panel wiring) and signal cables in the same conduits.

## DISPOSAL



The product is made from metal parts and plastic parts.

In reference to European Union directive 2002/96/EC issued on 27 January 2003 and the related national legislation, please note that:

1. WEEE cannot be disposed of as municipal waste and such waste must be collected and disposed of separately;
2. the public or private waste collection systems defined by local legislation must be used. In addition, the equipment can be returned to the distributor at the end of its working life when buying new equipment.
3. the equipment may contain hazardous substances: the improper use or incorrect disposal of such may have negative effects on human health and on the environment;
4. the symbol (crossed-out wheeled bin) shown on the product or on the packaging and on the instruction sheet indicates that the equipment has been introduced onto the market after 13 August 2005 and that it must be disposed of separately;
5. in the event of illegal disposal of electrical and electronic waste, the penalties are specified by local waste disposal legislation.

# Content

<b>1. INTRODUCTION</b>	<b>7</b>
1.1 Models.....	7
1.2 Functions and main characteristics.....	8
<b>2. INSTALLATION</b>	<b>10</b>
2.1 IR33: panel mounting and dimensions.....	10
2.2 DIN rail mounting and dimensions.....	11
2.3 IR33/DN33 with temperature inputs - wiring diagrams.....	12
2.4 IR33/DN33 Universale with universal inputs - wiring diagrams.....	14
2.5 IR33/DN33 Universale with universal inputs - probe connections...	15
2.6 Connection diagrams.....	16
2.7 Installation.....	17
2.8 Programming key.....	18
<b>3. USER INTERFACE</b>	<b>19</b>
3.1 Display.....	19
3.2 Keypad.....	20
3.3 Programming.....	20
3.4 Setting the current date/time and the on/off times.....	21
3.5 Using the remote control (accessory).....	23
<b>4. COMMISSIONING</b>	<b>25</b>
4.1 Configuration.....	25
4.2 Preparing for operation.....	25
4.3 Switching the controller On/Off.....	25
<b>5. FUNCTIONS</b>	<b>26</b>
5.1 Temperature unit of measure.....	26
5.2 Probes (analogue inputs).....	26
5.3 Standard operating modes (parameters St1,St2,c0,P1,P2,P3).....	27
5.4 Validity of control parameters (parameters St1,St2,P1,P2,P3).....	30
5.5 Selecting the special operating mode.....	30
5.6 Special operating modes.....	31
5.7 Additional remarks on special operation.....	34
5.8 Outputs and inputs.....	34
<b>6. CONTROL</b>	<b>37</b>
6.1 Type of control (parameter c32).....	37
6.2 ti_PID, td_PID (parameters c62,c63, d62,d63).....	37
6.3 Auto-Tuning (parameter c64).....	37
6.4 Operating cycle.....	38
6.5 Operation with probe 2.....	39
<b>7. TABLE OF PARAMETERS</b>	<b>44</b>
7.1 Variables only accessible via serial connection.....	49
<b>8. ALARMS</b>	<b>50</b>
8.1 Types of alarms.....	50
8.2 Alarms with manual reset.....	50
8.3 Display alarm queue.....	50
8.4 Alarm parameters.....	50
8.5 Table of alarms.....	52
8.6 Relationship between dependence parameter and alarm causes.....	53
<b>9. TECHNICAL SPECIFICATIONS AND PRODUCT CODES</b>	<b>54</b>
9.1 Technical specifications.....	54
9.2 Cleaning the controller.....	55
9.3 Product codes.....	56
9.4 Conversion tables from IR32 universale.....	56
9.5 Software revisions.....	57

# 1. INTRODUCTION

IR33-DN33 Universale is a series of controllers designed for controlling the main physical values (temperature, pressure, humidity) -conditioning, refrigeration and heating units. There are two product lines: the first for two temperature probes only (NTC, NTC-HT, PTC, PT1000) and the second for two temperature probes with a wider range (NTC, NTC-HT, PTC, PT100, PT1000, J/K thermocouples), for pressure and humidity transducers or for general signal transmitters (0 to 1 V, 0 to 10 V, -0.5 to 1.3V voltage inputs, 0 to 5 V ratiometric inputs or 0 to 20 mA, 4 to 20 mA current inputs). See the table below. The models also differ according to the type of power supply (115 to 230 Vac or 12 to 24 Vac, 12 to 30 Vdc for controllers with temperature inputs only and 115 to 230 Vac or 24 Vac/Vdc for controllers with universal inputs) and which based on the model may be one, two or four relays, four PWM outputs for controlling external solid state relays (SSR), one or two relays plus one or two 0 to 10 Vdc analogue outputs (AO) respectively. The type of control can be set as ON/OFF (proportional) or proportional, integral and derivative (PID). A second probe can be connected for differential control or freecooling/freeheating, or for compensation based on the outside temperature. Alternatively, a second control cycle can be activated with independent set point, differential and dedicated outputs. The range includes models

for panel installation (IR33), with IP65 index of protection, and for DIN rail mounting (DN33). To simplify wiring, all the models are fitted with plug-in terminals. The controllers can be connected via a network to supervisory and telemaintenance systems.

The accessories available include:

- computer-based programming tool;
- remote control for operation and programming;
- programming key, with battery;
- programming key, with 230 Vac power supply;
- RS485 serial card;
- RS485 serial card, with possibility of reversing the Rx-Tx terminals;
- module for converting the PWM signal to a 0 to 10 Vdc or 4 to 20 mA analogue signal;
- module for converting the PWM signal to an ON/OFF relay signal.

## 1.1 Models

The following table describes the models and the main characteristics.

TYPE	IR33-DN33 UNIVERSALE				CHARACTERISTICS
	panel installation		DIN rail assembly		
	Temperature inputs (*)	Universal inputs (*)	Temperature inputs (*)	Universal inputs (*)	
1 relay	IR33V7HR20	IR33V9HR20	DN33V7HR20	DN33V9HR20	2AI, 2DI, 1DO, BUZ, IR, 115 to 230 V
	IR33V7HB20	IR33V9HB20	DN33V7HB20	DN33V9HB20	2AI, 2DI, 1DO, BUZ, IR, RTC, 115 to 230 V
	IR33V7LR20	IR33V9MR20 ●	DN33V7LR20	DN33V9MR20 ●	2AI, 2DI, 1DO, BUZ, IR, 12 to 24Vac, 12 to 30 Vdc (● = 24 Vac/Vdc)
2 relays	IR33W7HR20	IR33W9HR20	DN33W7HR20	DN33W9HR20	2AI, 2DI, 2DO, BUZ, IR, 115 to 230 V
	IR33W7HB20	IR33W9HB20	DN33W7HB20	DN33W9HB20	2AI, 2DI, 2DO, BUZ, IR, RTC, 115 to 230 V
	IR33W7LR20	IR33W9MR20 ●	DN33W7LR20	DN33W9MR20 ●	2AI, 2DI, 2DO, BUZ, IR, 12 to 24 Vac, 12 to 30 Vdc (● = 24 Vac/Vdc)
4 relays	IR33Z7HR20	IR33Z9HR20	DN33Z7HR20	DN33Z9HR20	2AI, 2DI, 4DO, BUZ, IR, 115 to 230V
	IR33Z7HB20	IR33Z9HB20	DN33Z7HB20	DN33Z9HB20	2AI, 2DI, 4DO, BUZ, IR, RTC, 115 to 230 V
	IR33Z7LR20	IR33Z9MR20 ●	DN33Z7LR20	DN33Z9MR20 ●	2AI, 2DI, 4DO, BUZ, IR, 12 to 24 Vac, 12 to 30 Vdc (● = 24 Vac/Vdc)
4 SSR	IR33A7HR20	IR33A9HR20	DN33A7HR20	DN33A9HR20	2AI, 2DI, 4SSR, BUZ, IR, 115 to 230V
	IR33A7HB20	IR33A9HB20	DN33A7HB20	DN33A9HB20	2AI, 2DI, 4SSR, BUZ, IR, RTC, 115 to 230V
	IR33A7LR20	IR33A9MR20 ●	DN33A7LR20	DN33A9MR20 ●	2AI, 2DI, 4SSR, BUZ, IR, 12 to 24 Vac, 12 to 30 Vdc (● = 24 Vac/Vdc)
1 relay +1 0 to 10 Vdc	IR33B7HR20	IR33B9HR20	DN33B7HR20	DN33B9HR20	2AI, 2DI, 1DO+1AO, BUZ, IR, 115 to 230 V
	IR33B7HB20	IR33B9HB20	DN33B7HB20	DN33B9HB20	2AI, 2DI, 1DO+1AO, BUZ, IR, RTC, 115 to 230 V
	IR33B7LR20	IR33B9MR20 ●	DN33B7LR20	DN33B9MR20 ●	2AI, 2DI, 1DO+1AO, BUZ, IR, 12 to 24 Vac, 12 to 30 Vdc (● = 24 Vac/Vdc)
2 relays +2 0 to 10 Vdc	IR33E7HR20	IR33E9HR20	DN33E7HR20	DN33E9HR20	2AI, 2DI, 2DO+2AO, BUZ, IR, 115 to 230 V
	IR33E7HB20	IR33E9HB20	DN33E7HB20	DN33E9HB20	2AI, 2DI, 2DO+2AO, BUZ, IR, RTC, 115 to 230 V
	IR33E7LR20	IR33E9MR20 ●	DN33E7LR20	DN33E9MR20 ●	2AI, 2DI, 2DO+2AO, BUZ, IR, 12 to 24 Vac, 12 to 30 Vdc (● = 24 Vac/Vdc)

Tab. 1.a

AI=analogue input; AO=analogue output; DI= digital input; DO=digital output (relay); BUZ=buzzer; IR=infrared receiver; RTC=Real Time Clock.

(\*)

### TYPES OF PROBES/INPUTS AVAILABLE

	Temperature inputs	Universal inputs
NTC	-50T90°C	-50T110°C
NTC-HT	-40T150°C	-10T150°C
PTC	-50T150°C	-50T150°C
PT1000	-50T150°C	-199T800°C
PT100	-	-199T800°C
TC J/K	-	-100T800°C
0 to 1 V	-	Max range -199 to 800
-0.5 to 1.3 V	-	Max range -199 to 800
0 to 10 V	-	Max range -199 to 800
0 to 5 V ratiometric	-	Max range -199 to 800
0 to 20 mA	-	Max range -199 to 800
4 to 20 mA	-	Max range -199 to 800

Tab. 1.b

Note that the type of outputs can be identified from the code:

- the fifth letter V/W/Z corresponds to 1,2,4 relay outputs respectively;
- the fifth letter A corresponds to 4 SSR outputs;
- the fifth letter B/E corresponds to 1 or 2 relays and 1 or 2 x 0 to 10 Vdc analogue outputs respectively.

The type of power supply can also be identified:

- the seventh letter H corresponds to the 115 to 230 Vac power supply;
- the seventh letter L indicates the 12/24 Vac or 12/30Vdc power supply on models with temperature inputs only and M the 24 Vac/24Vdc power supply on models with universal inputs.

## 1.2 Functions and main characteristics

The IR33/DN33 controllers feature two main types of operation: "direct" and "reverse", based on the value measured. In "direct" operation, the output is activated if the value measured exceeds the set point plus a differential, and thus aims to keep the value below a certain level (typically used in refrigeration systems). Vice-versa, in "reverse" operation the output is activated when the temperature falls below the set point plus a differential (typically used in heating systems).

There are nine preset operating modes in which the installer can choose the set point and the activation differential.

In "special" operating mode, the exact activation point and deactivation and the control logic, "direct" or "reverse", can both be set, guaranteeing significant flexibility. Finally, automatic cycles can be programmed, called "operating cycles", used for example in processes where the temperature must remain above a certain value for a minimum time (pasteurisation). An operating cycle is defined by five time intervals in which the temperature must reach a certain set point. The operating cycle is activated on the keypad, via digital input or automatically on the models with RTC. On all models, it runs for the set time, thanks to the internal timer. The remote control, an accessory available for all the controllers, has the same buttons as the controller interface, and in addition can directly display the most frequently used parameters. Based on the model of controller, the output activated may be a relay, a PWM signal for solid state relays (SSR) or a voltage that increases linearly from 0 to 10 Vdc. The PWM output can also be converted, using the following modules:

- CONVO/10A0: conversion from PWM output for SSR to a linear 0 to 10 Vdc or 4 to 20 mA analogue signal;
- CONONOFF0: conversion from PWM output for SSR to an ON/OFF relay output.

Starting firmware revision 2.0, IR33 Universale can manage two circuits with independent PID control. New software functions have also been introduced, such as speed-up, cut-off and forcing the output from digital input, which can be selected for each output. See the paragraph "Software revisions" and the chapter "Functions".

Below is a description of the accessories for the IR33/DN33 Universal:

### ComTool programming tool (downloadable from <http://ksa.carel.com>)

With this useful tool, the controller can be programmed from any PC, saving the different configurations to files that can be loaded during the final programming stage, creating custom sets of parameters for faster programming and setting different user profiles with access protected by password.

The PC must be fitted with the USB/RS485 converter (CVSTDUMOR0) and the RS485 serial interface (IROPZ48500).

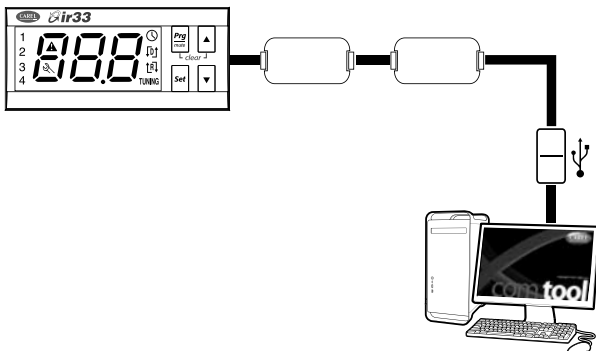

Fig. 1.a

### Remote control (cod. IRTUES000)

Used to directly access the main functions, the main configuration parameters and to program the controller from a distance, using a group of buttons that exactly replicate the keypad on the controller.

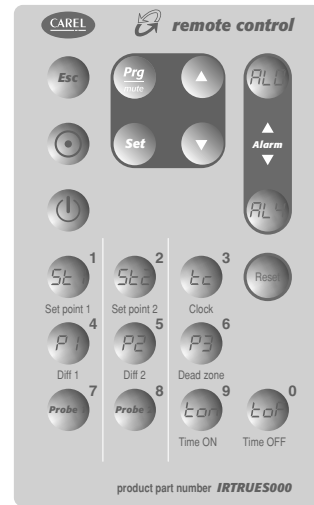

Fig. 1.b

### Programming key (code IROPZKEY00) and programming key with power supply (code IROPZKEYA0)

The keys can be used to quickly program the controllers, even when not connected to the powered supply, reducing the risk of errors. These accessories also allow fast and effective technical service, and can be used for programming the controllers in just a few seconds, also during the testing phase.

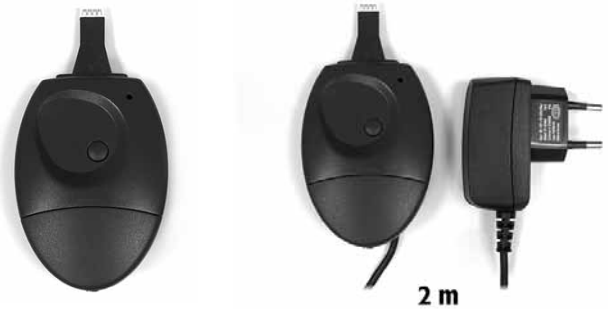

Fig. 1.c

### RS485 serial interface (code IROPZ48500 & IROPZ485S0)

These fit directly into the connector that normally is used for programming via key, and allow connection to the PlantVisor supervisory system. These options have been designed to remain outside of the controller and consequently the connection to the PlantVisor supervisory system can be installed at any time, even subsequently, if the system requires. Model IROPZ485S0 features a microprocessor and can automatically recognise the TxRx+ and TxRx- signals (possibility to reverse the connection).



Fig. 1.d

**USB/RS485 converter (CVSTDUMOR0)**

The USB/RS485 converter is an electronic device used to interface a RS485 network to a personal computer via the USB port.

**Fig. 1.e****RS485 card (code IROPZSER30)**

Used to connect the DN33 via the RS485 serial network to the PlantVisor supervisory system.

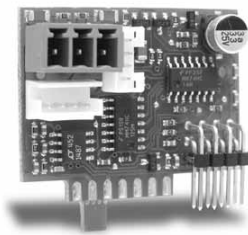
**Fig. 1.f****Analogue output module (code CONV0/10A0)**

Converts the PWM signal for solid state relays (SSR) to a standard 0 to 10 Vdc or 4 to 20 mA signal. For models IR/DN33A7\*\*\*\* and IR33D7\*\*\*\* only.

**Fig. 1.g****ON/OFF module (code CONVONOFF0)**

This module converts a PWM signal for solid state relays to an ON/OFF relay output. Useful when the IR/DN33A7\*\*\*\* or IR33D7\*\*\*\* controller needs to be used with one or more outputs to control solid state relays, and at the same time one or more ON/OFF outputs are required for the control functions or alarms.

**Fig. 1.h**

## 2. INSTALLATION

### 2.1 IR33: panel mounting and dimensions

#### 2.1.1 IR33 - temperature inputs

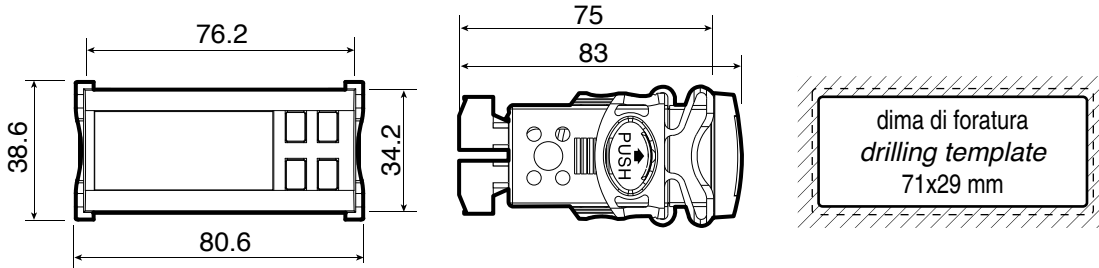

#### 2.1.2 IR33 - universal inputs

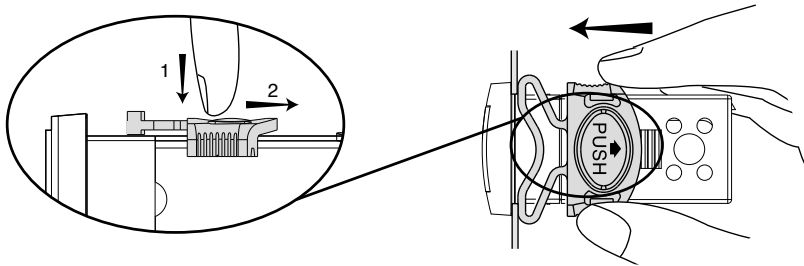
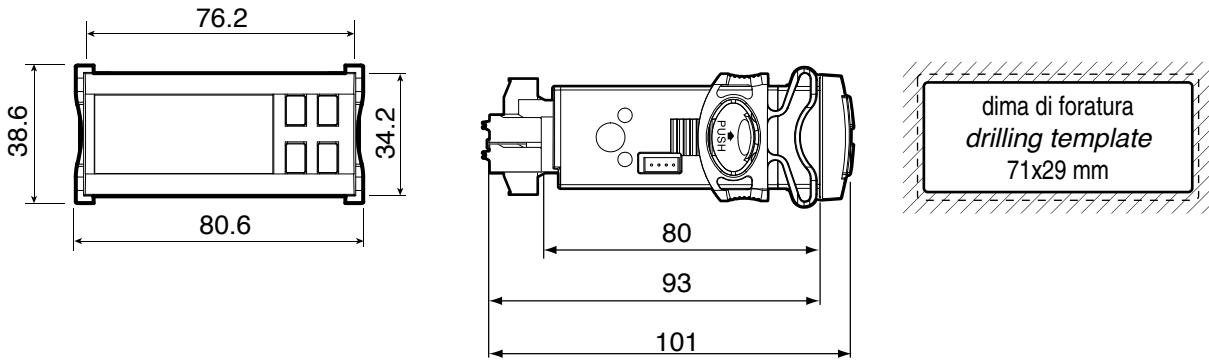

#### 2.1.3 IR33 - optional connections

##### Temperature inputs

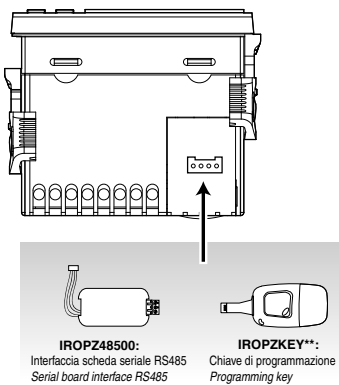

##### Universal inputs

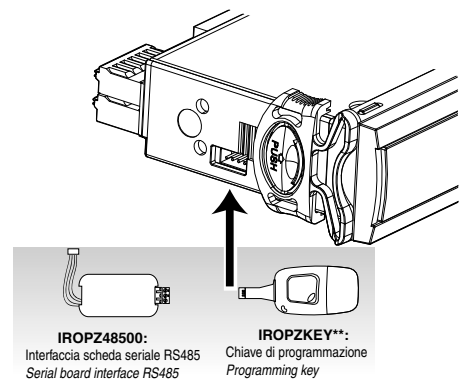

## 2.2 DIN rail mounting and dimensions

### 2.2.1 DN33 - Temperature inputs

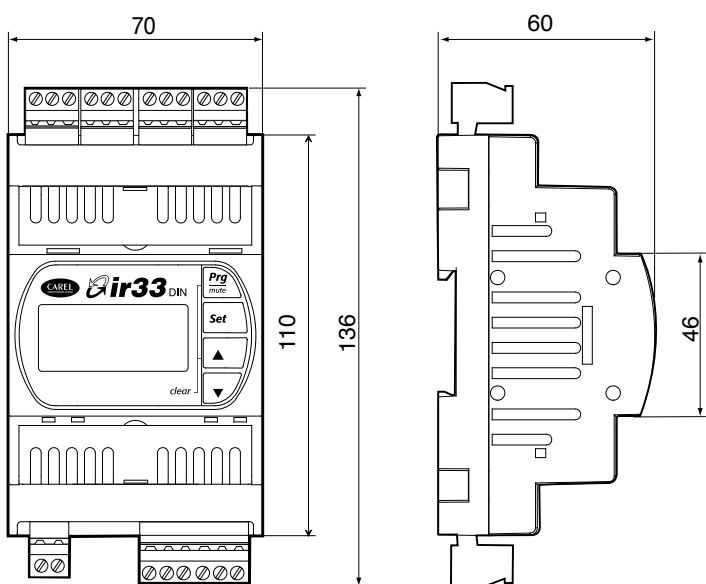

### 2.2.2 DN33 - Universal inputs

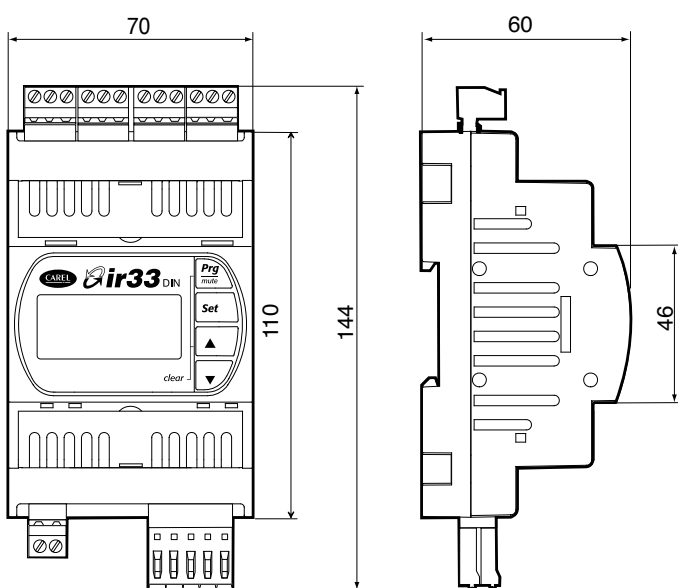

### 2.2.3 DN33 - optional connections

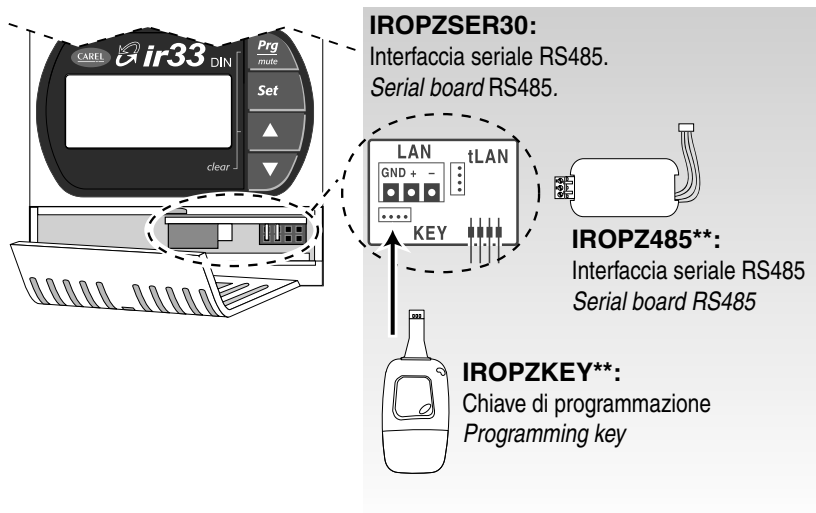



## 2.3 IR33/DN33 with temperature inputs - wiring diagrams

### 2.3.1 IR33

The models with 115/230 Vac and 12/24 Vac power supply have the same wiring diagram because the polarity of the power supply connection is not important.

#### IR33V7HR20 / IR33V7HB20 / IR33V7LR20

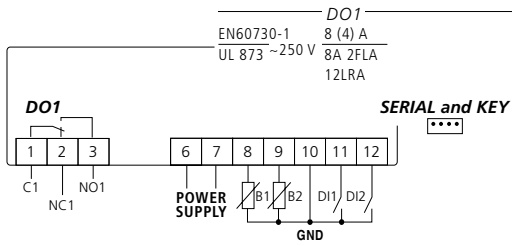

#### IR33W7HR20 / IR33W7HB20 / IR33W7LR20

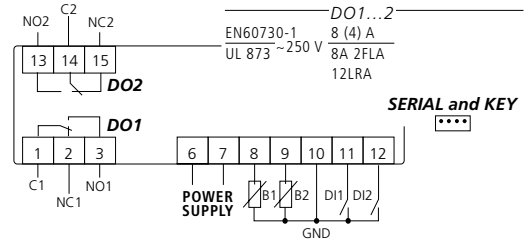

Relays

#### IR33Z7HR20 / IR33Z7HB20 / IR33Z7LR20

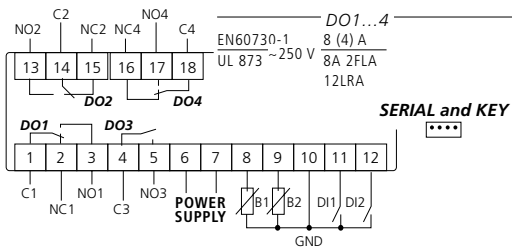

#### IR33A7HR20 / IR33A7HB20 / IR33A7LR20

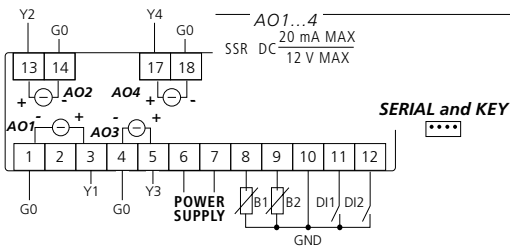

SSR

#### IR33B7HR20 / IR33B7HB20 / IR33B7LR20

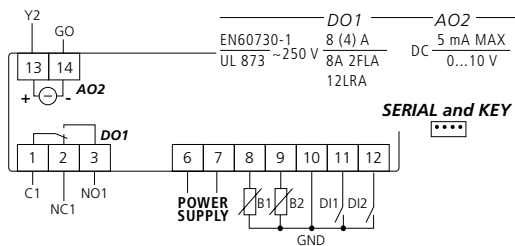

Relays  
+ 0-10Vdc

#### IR33E7HR20 / IR33E7HB20 / IR33E7LR20

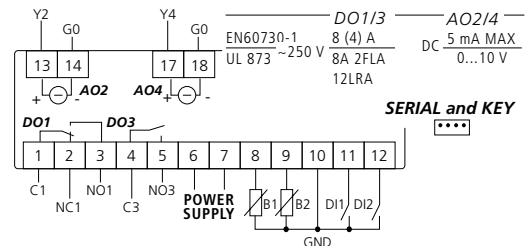

2.3.2 DN33

DN33V7HR20 / DN33V7HB20  
 DN33W7HR20 / DN33W7HB20  
 DN33Z7HR20 / DN33Z7HB20

DN33V7LR20  
 DN33W7LR20  
 DN33Z7LR20

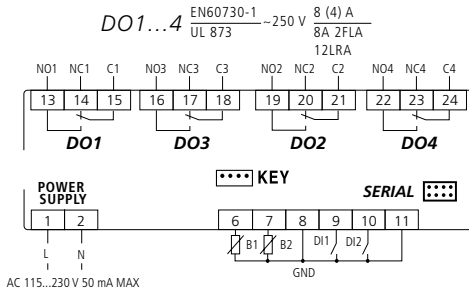

Relays

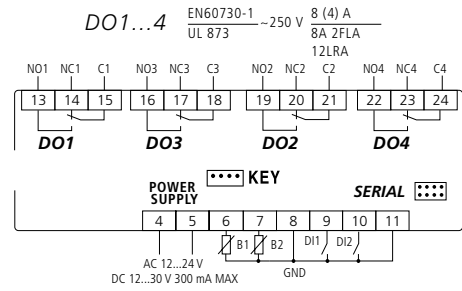

DN33A7HR20 / DN33A7HB20

DN33A7LR20

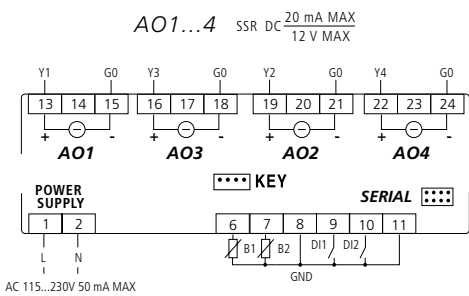

SSR

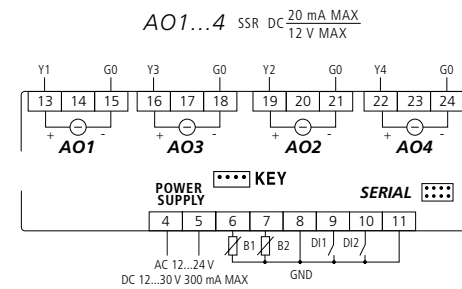

DN33B7HR20 / DN33B7HB20  
 DN33E7HR20 / DN33E7HB20

DN33B7LR20  
 DN33E7LR20

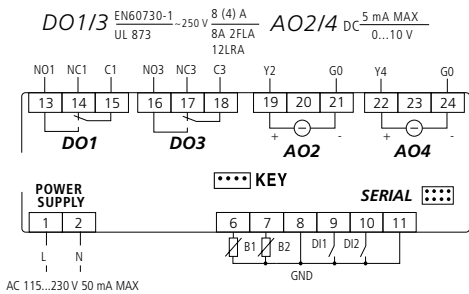

Relays +  
0...10 Vdc

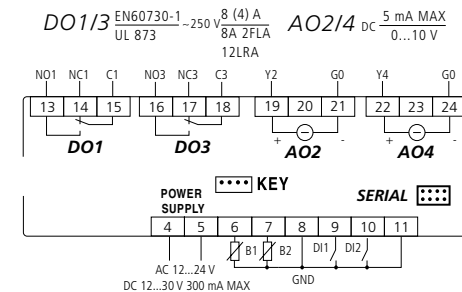

DN33 models with 1DO, 2DO, 1DO+1AO show the complete screen printing, including the outputs that are not available.

Key	
POWER SUPPLY	Power supply
DO1/DO2/DO3/DO4	Digital output 1/2/3/4 (relays 1/2/3/4)
AO1/AO2/AO3/AO4	PWM output for controlling external solid state relays (SSR) or 0 to 10 Vdc analogue output
G0	PWM or 0 to 10 Vdc analogue output reference
Y1/Y2/Y3/Y4	PWM or 0 to 10 Vdc analogue output signal
C/NC/NO	Common/Normally closed/Normally open (relay output)
B1/B2	Probe 1/Probe 2
DI1/DI2	Digital input 1/ Digital input 2

## 2.4 IR33/DN33 Universale with universal inputs - wiring diagrams

### 2.4.1 IR33

The models with 115/230 Vac and 24 Vac power supply have the same wiring diagram.

In the 230 Vac models, the line (L) is connected to terminal 7 and the neutral (N) to terminal 6. On the 24 Vac/Vdc models, make sure the polarity is correct (G, GO).

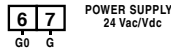

IR33V9HR20 / IR33V9HB20/ IR33V9MR20

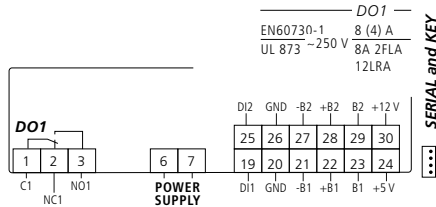

IR33W9HR20 / IR33W9HB20 / IR33W9MR20

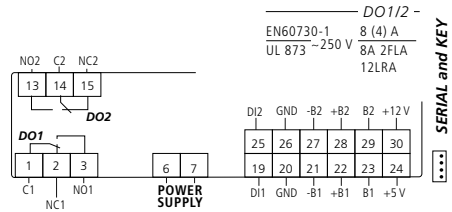

Relays

IR33Z9HR20 / IR33Z9HB20/ IR33Z9MR20

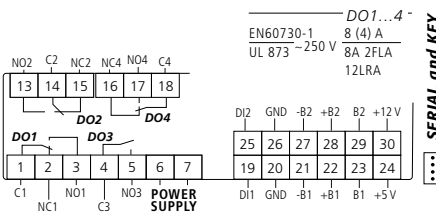

IR33A9HR20 / IR33A9HB20 / IR33A9MR20

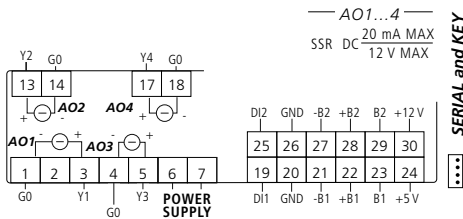

SSR

IR33B9HR20/IR33B9HB20/IR33B9MR20

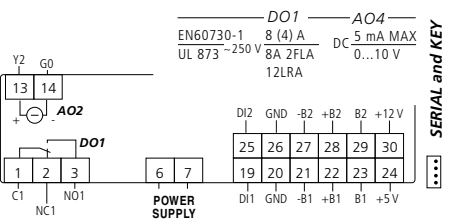

Relays,  
0-10V

IR33E9HR20/ IR33E9HB20/ IR33E9MR20

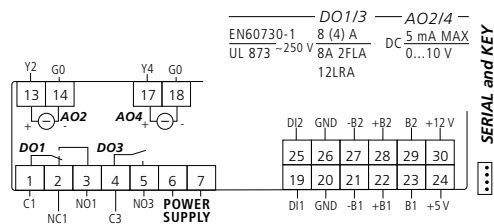

NOTE:

- All IR33 (temperature and universal inputs) and DN33 controllers (temperature inputs and universal inputs) have power terminals and outputs that correspond in terms of position and numbering;
- the probe and digital input connections are the same for IR33 and DN33 models with universal inputs. Only the numbering of the terminals changes.
- To connect two-wire PT1000 probes, jumper B1 and +B1 and B2 and +B2

Key	
POWER SUPPLY	Power supply
DO1/DO2/DO3/DO4	Digital output 1/2/3/4 (relays 1/2/3/4)
AO1/AO2/AO3/AO4	PWM output for controlling external solid state relays (SSR) or 0 to 10 Vdc analogue output
G0	PWM or 0 to 10 Vdc analogue output reference
Y1/Y2/Y3/Y4	PWM or 0 to 10 Vdc analogue output signal
C/NC/NO	Common/Normally closed/Normally open (relay output)
B1/B2	Probe 1/Probe 2
DI1/DI2	Digital input 1/ Digital input 2

2.4.2 DN33

DN33V9HR20 / DN33V9HB20  
 DN33W9HR20 / DN33W9HB20  
 DN33Z9HR20 / DN33Z9HB20

DN33V9MR20  
 DN33W9MR20  
 DN33Z9MR20

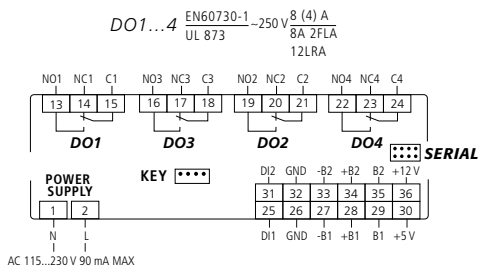

Relays

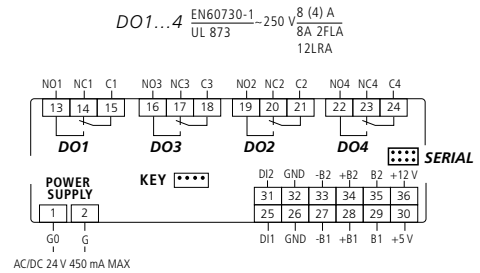

DN33A9HR20 / DN33A9HB20

DN33A9MR20

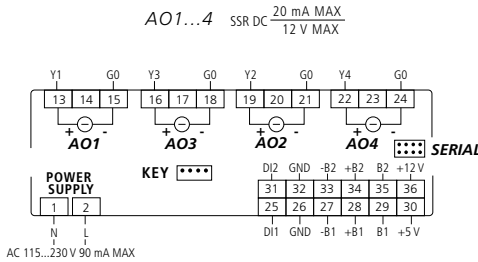

SSR

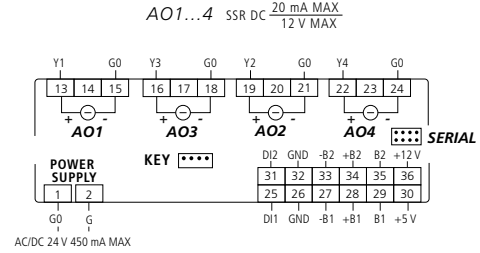

DN33B9HR20 / DN33B9HB20  
 DN33E9HR20 / DN33E9HB20

DN33B9MR20  
 DN33E9MR20

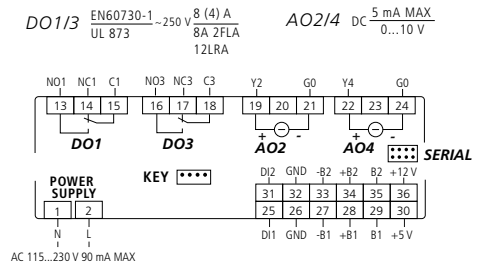

Relays +  
0-10 Vdc

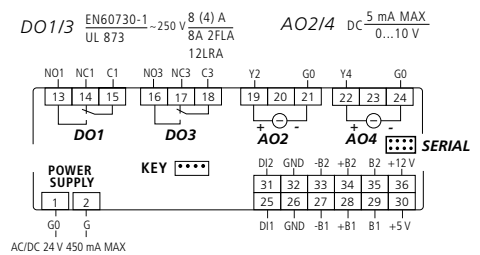

2.5 IR33/DN33 Universale with universal inputs - probe connections

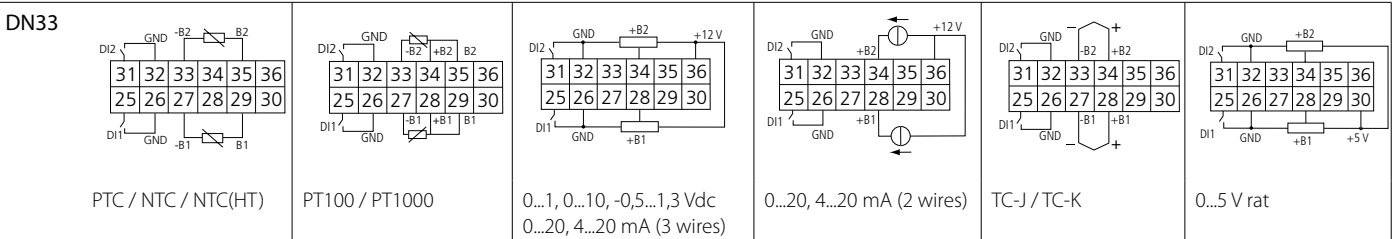
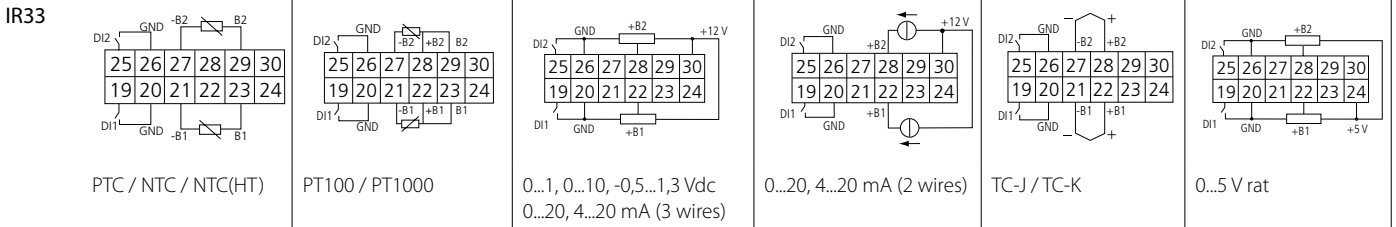

## 2.6 Connection diagrams

### 2.6.1 Connection to the CONV0/10VA0 and CONVONOFF0 modules (accessories)

The CONV0/10VA0 and CONVONOFF0 modules convert a PWM output for SSR to a 0 to 10 Vdc analogue output and ON/OFF relay output respectively. Below is an example of an application that uses model DN33A7LR20. Note that the same controller can thus have 3 different types of outputs. If only the 0 to 10 Vdc analogue output and the relay output are required, models DN33E7LR20 or DN33E9MR20 can be used; the wiring diagram is shown below.

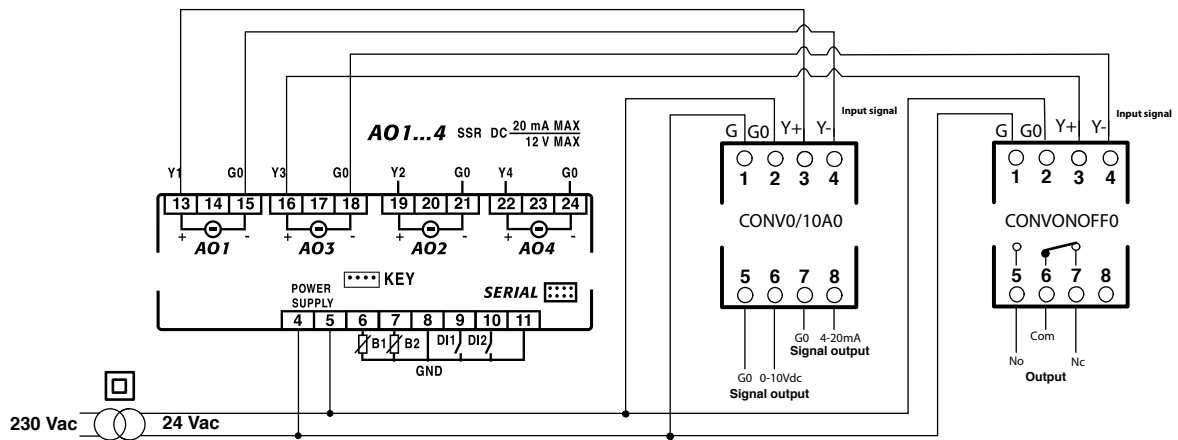
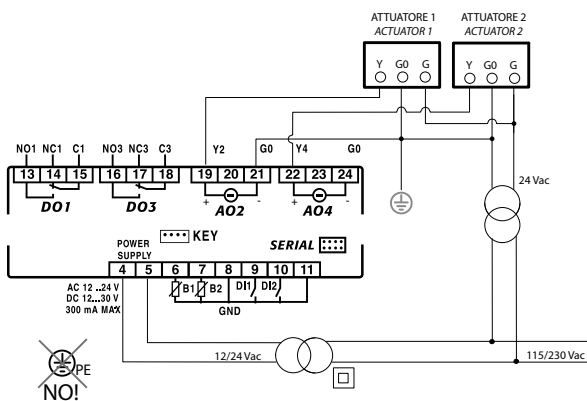

Fig. 2.a

Key

CONV0/10A0 & CONVONOFF modules		CONV0/10A0 module		CONVONOFF module	
Terminal	Description	Terminal	Description	Terminal	Description
1	24 Vac power supply	5	0 to 10 Vdc output reference	5	Normally open
2	Power supply reference	6	0 to 10 Vdc output	6	Common
3	PWM control signal (+)	7	4 to 20 mA output reference	7	Normally closed
4	PWM control signal (-)	8	4 to 20 mA output	8	Not connected

The control signal to terminals 3 & 4 on the CONV0/10VA0 and CONVONOFF modules is optically-isolated. This means that the power supply (G, G0) can be in common with the power supply to the controller.



#### TEMPERATURE INPUTS

- ⚠ On models B and E with direct or alternating current power supply, the reference (G0) for the 0 to 10 Vdc output and the power supply reference cannot be in common.
- ⚠ If the actuators connected to the analogue outputs require, the earth connection (PE) is performed making sure that this is on G0 of the ,outputs as shown in the figure.

Fig. 2.b

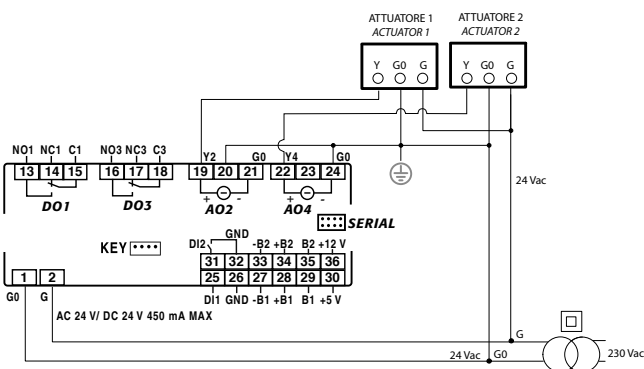

#### UNIVERSAL INPUTS

- ⚠ On models B and E with direct or alternating current power supply, the reference (G0) for the 0 to 10 Vdc output and the power supply reference may be in common. This means just one transformer can be used.
- ⚠ On the models with universal inputs, ensure the correct polarity of the power supply for 24 V versions (G, G0).

Fig. 2.c

## 2.7 Installation

To install the controller, proceed as follows, with reference to the wiring diagrams:

1. connect the probes and power supply: the probes can be installed up to a maximum distance of 100 m from the controller, using shielded cables with a minimum cross-section of 1 mm<sup>2</sup>. To improve immunity to disturbance, use probes with shielded cables (connect only one end of the shield to the earth on the electrical panel).
2. Program the controller: see the chapter "User interface".
3. Connect the actuators: the actuators should only be connected after having programmed the controller. Carefully check the maximum relay capacities, indicated in "technical specifications".
4. Serial network connection: if connection to the supervisor network is available using the relevant serial cards (IROPZ485\*0 for IR33 and IROPZSER30 for DN33), make sure the system is earthed. On controllers with 0 to 10 Vdc analogue outputs (models B and E) make sure there is only one earth connection. Specifically, the secondary of the transformers that supply the controllers must not be earthed (temperature only models). If connection to a transformer with earthed secondary winding is required, an insulating transformer must be installed in between. A series of controllers can be connected to the same insulating transformer, nevertheless it is recommended to use a separate insulating transformer for each controller.

**Case 1:** a series of controllers connected in a network powered by the same transformer (G0 not earthed). Typical application for multiple controllers connected inside the same electrical panel

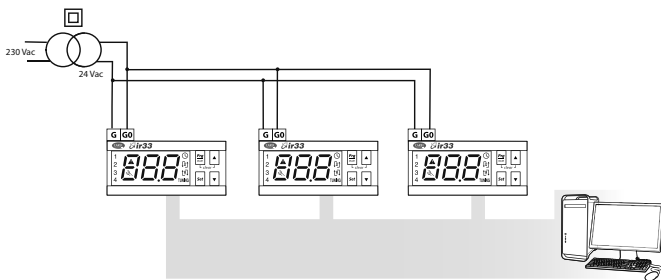

Fig. 2.d

**Case 2:** a series of controllers connected in a network powered by different transformers (G0 not earthed). Typical application for multiple controllers in different electrical panels.

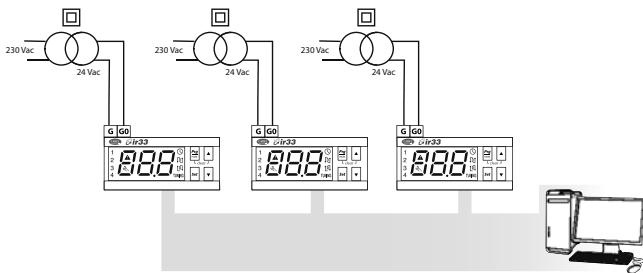

Fig. 2.e

⚠ Avoid installing the controller in environments with the following characteristics:

- relative humidity over 90% non-condensing;
- heavy vibrations or knocks;
- exposure to continuous jets of water;
- exposure to aggressive and polluting atmospheric agents (e.g.: sulphur and ammonia gases, saline mist, smoke) which may cause corrosion and/or oxidation;
- high magnetic and/or radio frequency interference (e.g. do not install near transmitting antennas);
- exposure to direct sunlight and atmospheric agents in general.

⚠ The following warnings must be observed when connecting the controllers:

- incorrect connection of the power supply may seriously damage the system;
- use cable ends that are suitable for the terminals. Loosen every screw and fit the cable end, next tighten the screws and gently pull the cables to check their tightness;
- separate as much as possible (at least 3 cm) the probe and digital input cables from inductive loads and power cables, to avoid any electromagnetic disturbance. Never lay power and probe cables in the same cable conduits (including those for the electrical panels);
- do not install the probe cables in the immediate vicinity of power devices (contactors, circuit breakers or the like). Reduce the length of the sensor cables as much as possible, and avoid spirals around power devices;
- avoid supplying the controller directly from the main panel power supply if also supplying power to other devices, such as contactors, solenoid valves, etc., which require another transformer.

## 2.8 Programming key

The keys must be connected to the connector (4 pin AMP) fitted on the controllers. All the operations can be performed with the controller off. The functions are selected using the 2 dipswitches, accessed by removing the battery cover:

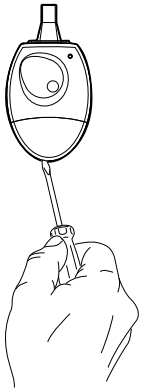

Fig. 2.f

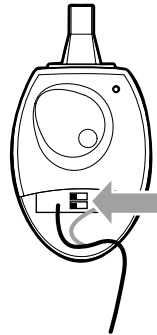

Fig. 2.g

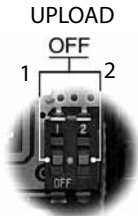

Fig. 2.h

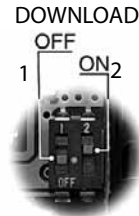

Fig. 2.i

- load the parameters for a controller onto the key (UPLOAD - Fig. 2.h);
- copy from the key to a controller (DOWNLOAD - Fig. 2.i);

**!** The parameters can only be copied between controllers with the same code. The UPLOAD operation can, however, always be performed.

### 2.8.1 Copying and downloading the parameters

The following operations are used for the UPLOAD and/or DOWNLOAD functions, simply by changing the settings of the dipswitches on the key:

1. open the rear cover on the key and position the 2 dipswitches according to the desired operation;
2. close the rear cover on the key and plug the key into the connector on the controller;
3. press the button and check the LED: red for a few seconds, then green, indicates that the operation was completed correctly. Other signals or the flashing of the LED indicates that problems have occurred: refer to the table;
4. at the end of the operation, release the button, after a few seconds the LED goes OFF;
5. remove the key from the controller.

LED signal	Error	Meaning and solution
Red LED flashing	Batteries discharged at start copy	The batteries are discharged, the copy operation cannot be performed. Replace the batteries.
Green LED flashing	Batteries discharged during copy or at end of copy	During the copy operation or at the end of the operation the battery level is low. Replace the batteries and repeat the operation.
Red/green LED flashing (orange signal)	Instrument not compatible	The parameter set-up cannot be copied as the connected controller model is not compatible. This error only occurs for the DOWNLOAD function; check the code of the controller and run the copy only for compatible codes.
Red and green LED on	Error in data being copied	Error in the data being copied. The data saved on the key are partly/completely corrupted. Reprogram the key.
Red LED on steady	Data transfer error	The copy operation was not completed due to a serious error when transferring or copying the data. Repeat the operation, if the problem persists check the key connections.
LEDs off	Batteries disconnected	Check the batteries.

### 3. USER INTERFACE

The front panel contains the display and the keypad, made up of 4 buttons, that, when pressed alone or combined with other buttons, are used to program the controller.

IR33 Universal front panel

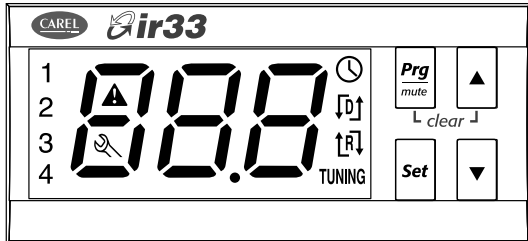

Fig. 3.a

DN33 Universale

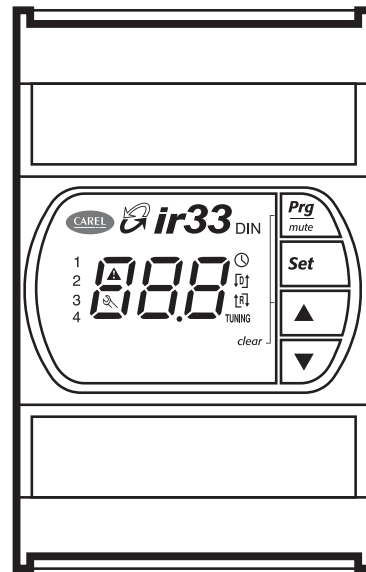

Fig. 3.b

#### 3.1 Display

The display shows the temperature in the range  $-50^{\circ}\text{C}$  to  $+150^{\circ}\text{C}$  in the models with temperature inputs only and in the range  $-199$  to  $+800^{\circ}\text{C}$  in the models with universal inputs. The temperature is displayed with resolution to tenths between  $-19.9^{\circ}\text{C}$  &  $+99.9^{\circ}\text{C}$ . Alternatively, it can show the value of one of the analogue or digital inputs, or the set point (see parameter c52). During programming, it shows the codes and values of the parameters.

Icon	Function	Normal operation			Start up	Notes
		ON	OFF	BLINK		
1	Output 1	Output 1 active	Output 1 not active	Output 1 request		Flashes when activation is delayed or inhibited by protection times, external disabling or other procedures in progress.
2	Output 2	Output 2 active	Output 2 not active	Output 2 request		See note for output 1
3	Output 3	Output 3 active	Output 3 not active	Output 3 request		See note for output 1
4	Output 4	Output 4 active	Output 4 not active	Output 4 request		See note for output 1
	ALARM		No alarm present	Alarms in progress		Flashes when alarms are active during normal operation or when an alarm is active from external digital input, immediate or delayed.
	CLOCK			Clock alarm Operating cycle active	ON if Real Time Clock present	
	REVERSE	Reverse operation active	Reverse operation not active	PWM /0 to 10 Vdc outputs		Signals operation of the unit in "reverse" mode, when at least one relay with "reverse" operation is active. Flashes if PWM/0 to 10 Vdc outputs.
	SERVICE		No malfunction	Malfunction (e.g. E2PROM error or probes faulty). Contact service		
TUNING	TUNING		AUTO-Tuning function not enabled	AUTO-Tuning function enabled		On if the AUTO-Tuning function is active
	DIRECT	Direct operation active	Direct operation not active	PWM /0 to 10 Vdc outputs		Signals operation of the unit in "direct" mode, when at least one relay with "direct" operation is active. Flashes if PWM/0 to 10 Vdc outputs.

Tab. 3.a

The user can select the standard display by suitably setting parameter c52, or by pressing (DOWN) to select one of the possible options (b1, b2, di1, di2, St1, St2) and confirming by pressing Set. See paragraph 3.4.11.



### 3.2 Keypad

<b>Prg</b> <b>mute</b>	<p>Pressing the button alone:</p> <ul style="list-style-type: none"> <li>• If pressed for more than 5 seconds, accesses the menu for setting the type P parameters (frequent);</li> <li>• Mutes the audible alarm (buzzer) and deactivates the alarm relay;</li> <li>• When editing the parameters, pressed for 5 s, permanently saves the new values of the parameters;</li> <li>• When setting the time and the on/off times returns to the complete list of parameters.</li> </ul> <p>Pressing together with other buttons</p> <ul style="list-style-type: none"> <li>• If pressed for more than 5 seconds together with Set, accesses the menu for setting the type C parameters (configuration);</li> <li>• If pressed for more than 5 seconds together with UP, resets any alarms with manual reset (the message 'RES' indicates the alarms have been reset); any alarm delays are reactivated;</li> </ul> <p>Start up</p> <ul style="list-style-type: none"> <li>• If pressed for more than 5 seconds at start up, activates the procedure for loading the default parameter values.</li> </ul>
▲	<p>(UP) Pressing the button alone:</p> <ul style="list-style-type: none"> <li>• Increases the value of the set point or any other selected parameter</li> </ul> <p>Pressing together with other buttons</p> <ul style="list-style-type: none"> <li>• If pressed for more than 5 seconds together with Prg/mute, resets any alarms with manual reset (the message 'RES' indicates the alarms have been reset); any alarm delays are reactivated.</li> </ul>
▼	<p>(DOWN) Pressing the button alone:</p> <ul style="list-style-type: none"> <li>• Decreases the value of the set point or any other selected parameter.</li> <li>• In normal operation accesses the display of the second probe, digital inputs and set point.</li> </ul>
<b>Set</b>	<p>Pressing the button alone:</p> <ul style="list-style-type: none"> <li>• If pressed for more than 1 second displays and/or sets the set point</li> </ul> <p>Pressing together with other buttons</p> <ul style="list-style-type: none"> <li>• If pressed for more than 5 seconds together with Prg/mute, accesses the menu for setting the type C parameters (configuration).</li> </ul>

Tab. 3.b

### 3.3 Programming

The operating parameters can be modified using the front keypad. Access differs depending on the type: set point, frequently-used parameters (P) and configuration parameters (c). Access to the configuration parameters is protected by a password that prevents unwanted modifications or access by unauthorised persons. The password can be used to access and set all the control parameters.

#### 3.3.1 Setting set point 1 (St1)

To change set point 1 (default =20°C):

- press **Set**: the display shows St1 and then the current value of St1;
- press ▲ or ▼ to reach the desired value;
- press **Set** to confirm the new value of St1;
- the display returns to the standard view.



Fig. 3.c

#### 3.3.2 Setting set point 2 (St2)

In operating modes 6, 7, 8 and 9 (see the chapter on Functions) and when c19=2,3,4 and 7 (see the chapter on Control) the controller works with two set points.

To change set point 2 (default =40 °C):

- press **Set** twice slowly: the display shows St2 and then the current value of St2;
- press ▲ or ▼ until reaching the required value;
- press **Set** to confirm the new value of St2;
- the display returns to the standard view.

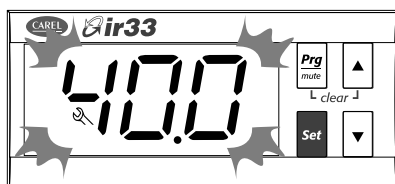

Fig. 3.d

#### 3.3.3 Setting type P parameters

Type P parameters (frequents) are indicated by a code beginning with the letter P, followed by one or two numbers.

1. Press **Prg mute** for more than 5 seconds (if an alarm is active, the buzzer is muted), the display shows the code of the first modifiable type P parameter, P1;
2. Press ▲ or ▼ until reaching the desired parameter. When scrolling, an icon on the display shows the category the parameter belongs to (see the table below and the table of parameters);
3. Press **Set** to display the associated value;
4. Increase or decrease the value using ▲ or ▼ respectively, until reaching the desired value;
5. Press **Set** to temporarily save the new value and return to the display of the parameter code;
6. Repeat operations from 2) to 5) to set other parameters;
7. To permanently save the new values of the parameters, press **Prg mute** for 5 s, thus exiting the parameter setting procedure.

#### ! Important:

- If no button is pressed for 10s, the display starts flashing, and after 1 minute automatically returns to the standard display, without saving the changes.
- To increase the scrolling speed, press and hold the ▲ / ▼ button for at least 5 seconds

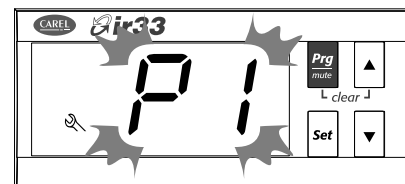

Fig. 3.e

### 3.3.4 Setting type c, d, F parameters

Type C, d or F (configuration) parameters are indicated by a code beginning with letters c, d, F respectively, followed by one or two numbers.

1. Press **Prg mute** e **Set** together for more than 5 seconds: the display shows the number 0;

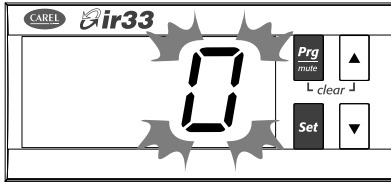

Fig. 3.f

2. Press **▲** or **▼** until displaying the password= 77;

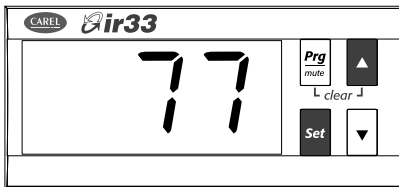

Fig. 3.g

3. Confirm by pressing **Set**;
4. If the value entered is correct, the first modifiable parameter c0 will be shown, otherwise the standard display will resume;
5. Press **▲** or **▼** until reaching the parameter to be modified. When scrolling, an icon appears on the display representing the category the parameter belongs to (see the table below and the table of parameters);
6. Press **Set** to display the associated value;
7. Increase or decrease the value using **▲** or **▼** respectively, until reaching the desired value;
8. Press **Set** to temporarily save the new value and return to the display of the parameter code;
9. Repeat operations from 5) to 8) to set other parameters;
10. To permanently save the new values of the parameters, press **Prg mute** for 5 s, thus exiting the parameter setting procedure.

⚠ This procedure can be used to access all the control parameters.

⚠ The password = 77 can only be changed from the supervisor or using the configuration tool (e.g. Comtool), range 0 to 200.

#### PARAMETER CATEGORIES

Category	Icon	Category	Icon
Programming		Output 2	2
Alarm		Output 3	3
PID	TUNING	Output 4	4
Output 1	1	RTC	

⚠ All the modifications made to the parameters, temporarily stored in the RAM, can be cancelled, returning to the standard display by not pressing any button for 60 seconds. The values of the clock parameters, however, are saved when entered.

⚠ If the controller is powered down before pressing **Prg mute**, all the modifications made to the parameters will be lost

▶ In the two parameter setting procedures (P and C), the new values are only saved after having pressed **Prg mute** for 5 seconds. When setting the set point, the new value is saved after confirming with **Set**.

### 3.4 Setting the current date/time and the on/off times

Applies to models fitted with RTC.

#### 3.4.1 Setting the current date/time

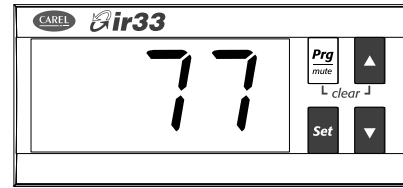

Fig. 3.h

1. Access the type C parameters as described in the corresponding paragraph;
2. Press the **▲ / ▼** buttons and select the parent parameter, tc;

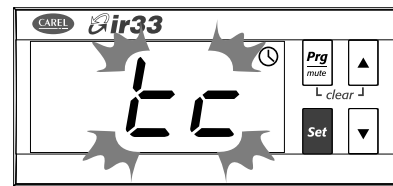

Fig. 3.i

3. Press **Set**: parameter y is displayed, followed by two digits that indicate the current year;
4. Press **Set** and set the value of the current year (e.g.: 8=2008), press **Set** again to confirm;
5. Press **▲** to select the next parameter -month -and repeat steps 3 & 4 for the following parameters:  
M=month, d=day of the month, u=day of the week  
h=hours, n=minutes;
6. To return to the list of main parameters, press **Prg mute** and then access parameters ton and toF (see the following paragraph), or:
7. To save the settings press **Prg mute** for 5 seconds and exit the parameter setting procedure.

#### 3.4.2 Setting the on/off times

1. Access the type c parameters as described in the corresponding paragraph;
2. Press the **▲ / ▼** buttons and select the parent parameter, ton = on time;

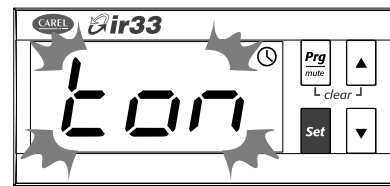

Fig. 3.j

3. Press **Set**: parameter d is displayed, followed by one or two digits that represent the on day, as follows:  
0= timed start disabled  
1 to 7= Monday to Sunday  
8= Monday to Friday  
9= Monday to Saturday  
10= Saturday & Sunday  
11= every day;
4. Press **Set** to confirm and go to the on time parameters h/m=hours/minutes;
5. To return to the list of main parameters, press **Prg mute**
6. Select and modify parameter toF together with the corresponding hour and minutes, repeating the sequence from point 2 to 5.



Fig. 3.k

7. To save the settings press **Prg mute** for 5 seconds and exit the parameter setting procedure, thus saving the settings permanently.

**3.4.3 Setting the default parameters**

To set the parameters to the default values:

- Power down the controller;
- Press **Prg mute**;
- Power up the controller holding the **Prg mute** button, until the message "Std" is shown on the display.

**!** This will cancel any changes made and restore the original values set by the manufacturer, that is, the defaults shown in the table of parameters, except for the password, which if changed from ComTool or the supervisor retains the value set previously.

**3.4.4 Test display and keypad at start-up**

Step	Display	Keypad	Note
One	Display completely off for 5 s	Press PRG for 5 seconds to set the defaults	
Two	Display completely on for 2 s	No effect	
Three	3 segments ("--") on	When pressing each button a dedicated segment lights up	This step  indicates whether the RTC is installed
Four	Normal operation	Normal operation	

Tab. 3.c

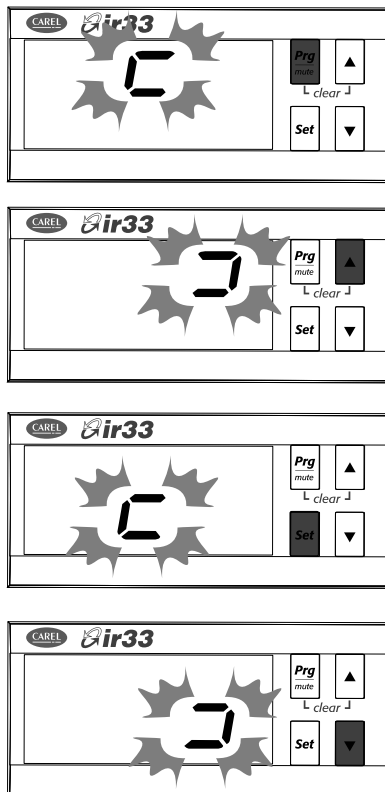

Fig. 3.l

**3.4.5 Alarms with manual reset**

The alarms with manual reset can be reset by pressing **Prg mute** and **▲ p** together for more than 5 seconds.

**3.4.6 Activating the operating cycle**

The operating cycle activation mode is selected using parameter P70 (see the chapter on Control). Below is a description of the activation procedure from the keypad (manual), digital input and RTC (automatic).

**3.4.7 Manual activation (P70=1)**

During the normal operation of the controller, pressing the **▲** button for 5 seconds displays CL, which indicates "operating cycle" mode is being accessed. The operating cycle features 5 temperature/time steps, which need to be set (see the chapter on Control). The operating cycle will be run and the clock icon will flash.

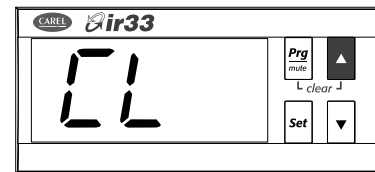

Fig. 3.m

The operating cycle ends automatically when it reaches the fifth step. To stop an operating cycle before the end, press the **▲** button again for 5 seconds. The message "StP" (stop) will be displayed.



Fig. 3.n

**3.4.8 Activation from digital input 1/2 (P70=2)**

To activate the operating cycle from digital input 1, set P70=2 and c29=5. For digital input 2 set P70=2 and c30=5. Connect the selected digital input to a button (NOT a switch). To activate the operating cycle, briefly press the button: this will be run, and the clock icon will flash. To stop an operating cycle before the end, press the **▲** button again for 5 seconds. The message "StP" (stop) will be displayed.

**3.4.9 Automatic activation (P70=3)**

The automatic activation of an operating cycle is only possible on the models fitted with RTC.

To activate an operating cycle automatically:

- Set the parameters for the duration of the step and the set point (P71-P80);
- Program the controller automatic on/off times – parameters ton and toF;
- Set parameter P70=3.

The operating cycle will start automatically when the controller switches on. To terminate an operating cycle in advance, press **▲** for 5 seconds. Termination of the operating cycle is indicated by the message "StP" (stop).

**3.4.10 Auto-Tuning activation**

See the chapter on Control. Auto-Tuning is incompatible with independent operation (c19=7).

**3.4.11 Displaying the inputs**

- Press ▼ : the current input will be displayed, alternating with the value:
  - b1 : probe 1;
  - b2 : probe 2;
  - di1 : digital input 1;
  - di2 : digital input 2.
  - St1 : set point 1;
  - St2 : set point 2.

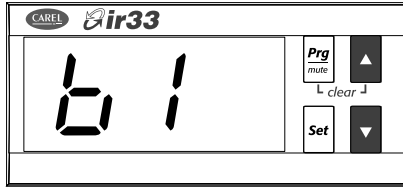

Fig. 3.o

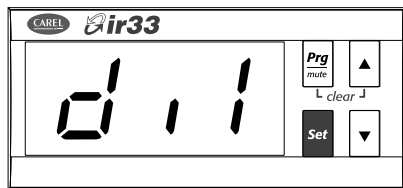

Fig. 3.p

- Press ▲ and ▼ to select the input to be displayed;
  - Press **Set** for 3 seconds to confirm.
- ⚠ If when scanning the inputs a digital input has not been configured, the display will show "nO" (indicating that the digital input does not exist or has not been configured), while "OPn" and "CLO" will be displayed to indicate, respectively, that the input is open or closed. For the probes, the value displayed will be the value currently measured by the probe or, if the probe is not fitted or not configured, the display will show "nO". For St2, this is only displayed if featured on the controller, otherwise the display shows "nO".

**3.4.12 Calibrating the probes**

Parameters P14 and P15 are used to calibrate the first and second probe respectively. See paragraph 5.2 for the difference in calibration between temperature probes and current and voltage inputs. Access the 2 parameters and then set the required values. When pressing **Set**, after having entered the value, the display does not show the parameter, but rather immediately shows the new value of the probe reading being calibrated. This means the result of the setting can be checked immediately and any adjustments made as a consequence. Press **Set** again to save the value.

**3.5 Using the remote control (accessory)**

The compact remote control with 20 buttons allows direct access to the following parameters:

- St1 (set point 1)
- St2 (set point 2)
- P1 (differential St1)
- P2 (differential St2)
- P3 (dead zone differential)

and the following functions can also be accessed:

- set the time
- display the value measured by the probes
- display the alarm queue and reset any alarms with manual reset, once the cause has been resolved.
- set the on time band (see the corresponding paragraph).

The remote control features the four buttons, **Prg mute**, **Set**, **▲** and **▼**, which access almost all the functions provided by the instrument keypad.

The buttons can be divided into three groups, based on their functions:

- Enabling/disabling the use of the remote control (Fig. 1);
- Remote simulation of the controller keypad (Fig. 2);
- Direct display/editing of the most common parameters (Fig. 3).

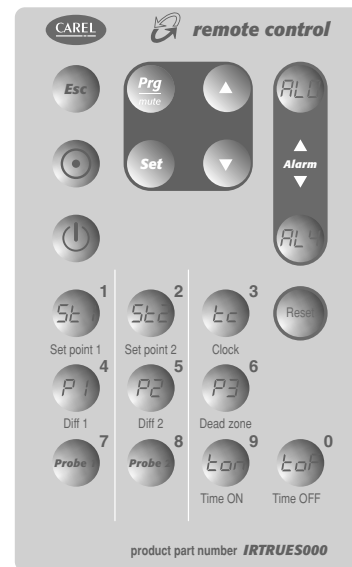

Fig. 3.q

**3.5.1 Remote control enable code (parameter c51)**

Parameter c51 attributes a code for accessing the controller. This means that the remote control can be used when there are a series of controllers on the same panel, without the risk of interference.

Par.	Description	Def	Min	Max	UM
c51	Code for enabling the remote control 0=Programming by remote control without code	1	0	255	-

Tab. 3.d

**3.5.2 Activating and deactivating the use of the remote control**

Button	Immediate function	Delayed function
	used to enable the remote control; each instrument displays its own enabling code	
	ends operation using the remote control, cancelling all changes made to the parameters	
		pressing and holding for 5s ends the operation of the remote control, saving the modified parameters
NUMS.	used to select the instrument, by entering the enabling code displayed.	

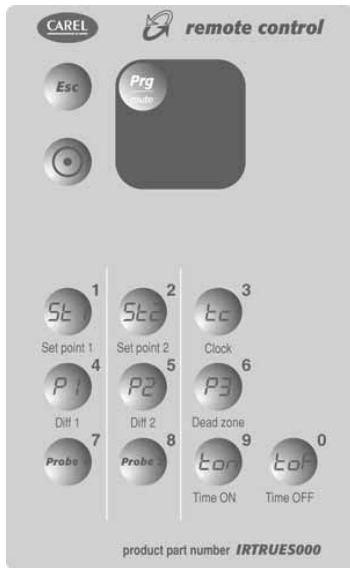



Fig. 3.r

The buttons used are shown in the figure. By pressing the  button, each instrument displays its own remote control enabling code (parameter c51). The numeric keypad is used to enter the enabling code of the instrument in question. At the end of this operation, only the instrument with the selected enabling code will be programmed from the remote control, all the others will resume normal operation. Assigning different enabling codes to the instruments, allows, in this phase, only the desired instrument to be programmed using the remote control, without the risk of interference. The instrument enabled for programming from the remote control will display the reading and the message rCt. This status is called Level 0. Press  to exit the programming of the remote control, without saving the modifications.

### 3.5.4 Direct display/editing of the most common parameters

Some parameters are directly accessible using specific buttons:

- St1 ( set point 1);
- St2 ( set point 2);
- P1 (differential St1);
- P2 (differential St2);
- P3 (dead zone differential)

and the following functions can also be accessed:

- set the current time(tc);
- display the value measured by the probes (Probe1, Probe2);
- display the alarm queue (AL0-AL4);
- reset any alarms with manual reset, once the cause has been resolved;
- set the on time band ( ton, toF), see the corresponding paragraph.

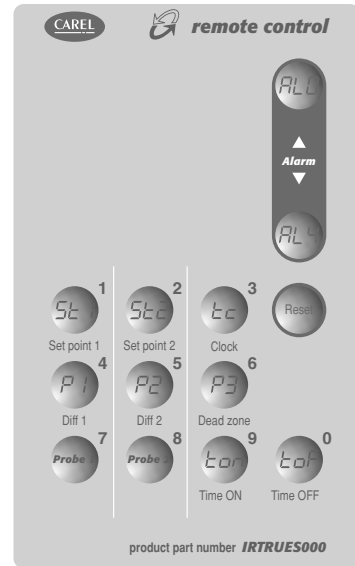





Fig. 3.t

### 3.5.3 Remote simulation of the controller keypad

The buttons used are shown in the figure. In Level 0 (display the reading and message rCt), the following functions are active:

Button	Immediate function
	Mute the buzzer, if ON

In this level, the **Set** and  buttons are also active, used to activate the set point (Level 1) and the configuration parameters (Level 2).

Button	Immediate function	Delayed function
		Pressing and holding for 5s saves the modified parameters and ends the operation of the remote control
	Set the set point	



In Levels 1 and Level 2, the , **Set**,  and  buttons repeat the corresponding functions on the controller keypad. In this way, all the controller parameters can be displayed and set, even those without shortcut buttons.



Fig. 3.s

## 4. COMMISSIONING

### 4.1 Configuration

The configuration parameters should be set when commissioning the controller, and involve:

- serial address for the network connection;
- enabling the keypad, buzzer and the remote control (accessory);
- setting a delay for starting control after the device is powered up (delay at start-up);
- gradual increase or reduction in the set point (soft start).

#### 4.1.1 Serial address (parameter c32)

c32 assigns the controller an address for the serial connection to a supervisory and/or telemaintenance system.

Par.	Description	Def	Min	Max	UoM
c32	Serial connection address	1	0	207	-

Tab. 4.a

#### 4.1.2 Disable keypad/remote control (parameter c50)

Some functions relating to the use of the keypad can be disabled, for example, the setting of the parameters and the set point if the controller is exposed to the public.

Par.	Description	Def	Min	Max	UoM
c50	Disable keypad and remote control	1	0	2	-

Tab. 4.b

Below is a summary of the modes that can be disabled:

Par c50	Edit P parameters	Change set point	Settings from remote control
0	NO	NO	YES
1	YES	YES	YES
2	NO	NO	NO

Tab. 4.c

With the "change set point" and "edit P parameters" functions disabled, the set point and the type P parameters cannot be changed, however the values can be displayed. The type c parameters, on the other hand, being protected by password, can be set on from keypad, following the standard procedure. With the remote control disabled, the values of the parameters can be displayed but not set. See the paragraph on using the remote control.

⚠ If c50 is set =2 from the remote control, this is instantly disabled. To re-enable the remote control, set c50=0 or c50=1 on the keypad.

#### 4.1.3 Show standard display/disable buzzer (parameters c52,c53)

Par.	Description	Def	Min	Max	UoM
c52	Display	0	0	3	-
	0=Probe 1				
	1=Probe 2				
	2=Digital input 1				
	3=Digital input 2				
	4= Set point 1				
c53	5= Set point 2				
	6= Probe 1 / Probe 2 alternating				
	Buzzer	0	0	1	-
	0=Enabled				
	1=Disabled				

Tab. 4.d

#### 4.1.4 Delay at start-up (parameter c56)

Used to delay the start of control when the device is powered up. This is useful in the event of power failures, so that the controllers (in the network) don't all start at the same time, avoiding potential problems of electrical overload.

Par.	Description	Def	Min	Max	UoM
c56	Delay at start-up	0	0	255	s

Tab. 4.e

#### 4.1.5 Soft start (parameter c57, d57)

This function is used to gradually increase or decrease the set point according to the value of the parameter. The function is useful if the controller is used in cold rooms or seasoning rooms, or in similar situations when starting at full load may not be compatible with the required process. Soft start, if active, is used on power-up or within an operating cycle. The unit of measure is expressed in minutes / °C. Parameter d57 acts on circuit 2 if independent operation is active.

Par.	Description	Def	Min	Max	UoM
c57	Soft start	0	0	99	min/°C
d57	Soft start circuit 2	0	0	99	min/°C

Tab. 4.f

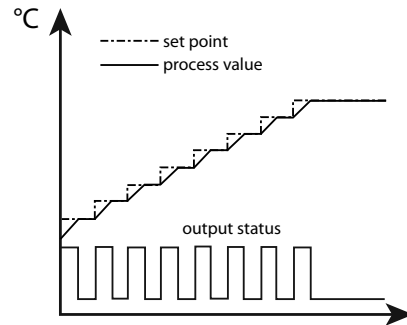

Fig. 4.a

Example: when c57=5, assuming the set point is 30°C and the differential 2 °C, and that the ambient temperature is 20°C; on power-up the virtual set point will be the same as the temperature measured, and will remain at this value for 5 minutes. After 5 minutes, the virtual set point will be 21 degrees, no outputs will be activated, while after another 5 minutes the virtual set point will be 22°C, thus entering the control band (as the differential is 2°C) and heating will start. Once the temperature reaches the virtual set point, the function stops and the process continues.

### 4.2 Preparing for operation

Once having completed the installation, configuration and programming operations, before starting the controller check that:

- The wiring is performed correctly;
- The programming logic is suitable for controlling the unit and the system being managed: Starting from revision FW 2.0 two PID control cycles can be set on two independent circuits;
- If the controller is fitted with RTC (clock), set the current time and the on and off times;
- Set the standard display;
- Set the "probe type" parameter based on the probe available and the type of control (NTC, NTC-HT, PTC, PT1000, J/K thermocouple, voltage/current input);
- Set the type of control: ON/OFF (proportional) or proportional, integral, derivative (PID);
- If used as a thermostat, set the unit of measure for the probes (°C or °F), see paragraph 5.1;
- Any operating cycles are programmed correctly;
- The protection functions (delay at start-up, rotation, minimum on and off times for the outputs) are active;
- The remote control enabling code is set, if a series of controllers are installed in the same system;
- If the CONV0/10A0 module is connected, the cycle time is set to the minimum (c12=0.2 s);
- The special mode is set in the correct sequence, i.e. first parameter c0 is set, and then parameter c33 (see the chapter on Functions).

### 4.3 Switching the controller On/Off

The unit can be switched ON/OFF from a number of sources; supervisor, digital input (parameters c29,c30) and remote control. The digital input has highest priority in switching ON/OFF. Starting from revision 2.0 an output can be selected for ON-OFF status (see "dependence").

⚠ If more than one digital input is selected as On/Off, the ON status will be activated when all the digital inputs are closed. If just one contact is open, the unit is switched OFF.

In OFF status set from digital input, the outputs and switching ON/OFF from remote control or the supervisor are disabled, while the following functions are enabled:

- editing and display of the frequent and configuration parameters, and the set point;
- selection of the probe to be displayed;
- probe 1 error (E01), probe 2 error (E02), clock alarm (E06), EEPROM alarm (E07 and E08);
- When switching ON and OFF the control output protection times are taken into consideration;

## 5. FUNCTIONS

In the tables, the parameters that are repeated highlight the differences in settings between the models with universal inputs and the models with temperature inputs only.

### 5.1 Temperature unit of measure

On IR33 Universale the temperature unit of measure can be changed from degrees Celsius to degrees Fahrenheit using parameter c18.

Par.	Description	Def	Min	Max	UOM
c18	Temperature unit of measure 0=°C; 1=°F	0	0	1	-

Tab. 5.a

The models with universal inputs can be connected to PT100 or PT1000 probes and thermocouples, and operate with temperatures from -199°C to 800°C, consequently the parameters corresponding to the minimum and maximum limits of the set point are different. See the table below. The function works as follows:

- in degrees Celsius the settable temperature range is -199T800°C;
- in degrees Fahrenheit the settable temperature range is -199T800°F.

Due to the conversion using the formula:

$$T(^{\circ}\text{F})=T(^{\circ}\text{C}) \times 1.8 + 32$$

the settable temperature range in degrees Celsius is wider than in degrees Fahrenheit.

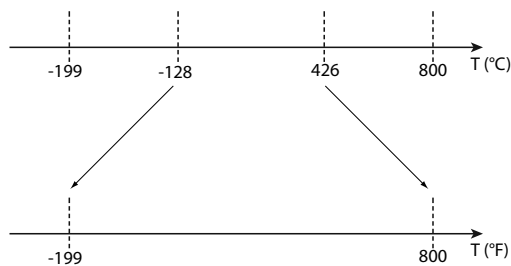

Fig. 5.a



- If the display is showing the reading of probe 1 or 2 in the range between -199°C and -128°C or between 426°C and 800°C, and the unit is set to degrees Fahrenheit, the error E01 or E02 will be shown;
- If the controller is working in degrees Celsius and the temperature set point is set over 426°C or below -128°C, if then switching to degrees Fahrenheit the set point will be limited to 800°F and -199°F respectively.

### 5.2 Probes (analogue inputs)

The probe parameters are used to :

- set the type of probe
- set the offset to correct the probe reading (calibration)
- set the maximum/minimum current/voltage value;;
- activate a filter to stabilise the reading
- set the unit of measure shown on the display
- enable the second probe and the compensation function. IR33 Universale models with universal inputs have wider ranges for NTC and PT1000 temperature probes than the IR33 Universale models with temperature only. In addition these can use thermocouples, active probes and voltage and current inputs, as shown in the table.

Par.	Description	Def	Min	Max	UoM
c13	Probe type 0= Standard NTC range(-50T+90°C) 1= NTC-HT enhanced range(-40T+150°C) 2= Standard PTC range(-50T+150°C) 3= Standard PT1000 range(-50T+150°C)	0	0	3	-

c13	Probe type 0= NTC range (-50T+110°C) 1= NTC-HT range (-10T+150°C) 2= PTC range (-50T+150°C) 3= PT1000 range (-50T+200°C) 4= PT1000 range (-199T+800°C) 5= Pt100 range (-50T+200°C) 6= Pt100 range (-199T+800°C) 7= J thermocouple range (-50T+200°C) 8= J thermocouple range (-100T+800°C) 9= K thermocouple range (-50T+200°C) 10= K thermocouple range (-100T+800°C) 11= 0 to 1 Vdc input 12=- 0.5 to 1.3 Vdc input 13= 0 to 10 Vdc input 14= 0 to 5 Vdc ratiometric 15= 0 to 20 mA input 16= 4 to 20 mA input	0	0	16	-
P14	Probe 1 calibration	0 (0)	-20 (-36)	20 (36)	°C(°F)
P15	Probe 2 calibration	0 (0)	-20 (-36)	20 (36)	°C(°F)
P14	Probe 1 calibration	0 (0)	-99,9 (-179)	99,9 (179)	°C(°F)
P15	Probe 2 calibration	0 (0)	-99,9 (-179)	99,9 (179)	°C(°F)
c15	Minimum value for probe 1 with current/voltage signal	0	-199	c16	-
c16	Maximum value for probe 1 with current/voltage signal	100	c15	800	-
d15	Minimum value for probe 2 with current/voltage signal	0	-199	d16	-
d16	Maximum value for probe 2 with current/voltage signal	100	d15	800	-
c17	Probe disturbance filter	4	1	15	-

Tab. 5.b



When a probe with current/voltage signal is selected, the unit of measure must be left at °C (C18=0).

Parameter c13 defines the type of probe 1 (B1) and any probe 2 (B2). For controllers with universal inputs, the corresponding selections are highlighted in the table. Parameters P14 and P15, for probe 1 and probe 2 respectively, are used to correct the temperature measured by the probes indicated on the display, using an offset: the value assigned to these parameters is in fact added to (positive value) or subtracted from (negative value) the temperature measured by the probes. When pressing Set, after having entered the value, the display does not show the parameter, but rather immediately shows the new value of the probe reading being calibrated. This means the result of the setting can be checked immediately and any adjustments made as a consequence. Press Set again to access the parameter code and save the value. For probes with current/voltage signals, parameters c15, c16 for probe 1 and d15, d16 for probe 2 are used to "scale" the probe output signal. The value of parameters P14, P15 is added after this operation.

Example: 0 to 10 Vdc input on B1, c15=30, c16=90, P14= 0

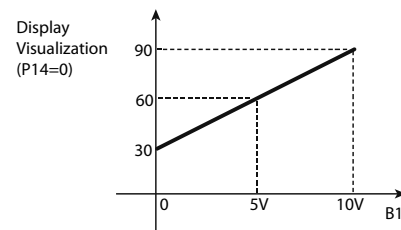

Fig. 5.b

Consequently, 0V will be as displayed 30 and 10V will be displayed as 90. These are also the values used for control.

Parameter c17 defines the coefficient used to stabilise the temperature reading. Low values assigned to this parameter allow a prompt response of the sensor to temperature variations, but the reading becomes more sensitive to disturbance. High values slow down the response, but guarantee greater immunity to disturbance, that is, a more stable and more precise reading.

5.2.1 Second probe (parameter c19)

Par.	Description	Def	Min	Max	UoM
c19	Operation of probe 2 0=not enabled 1=differential operation 2=compensation in cooling 3=compensation in heating 4=compensation always active 5=enable logic on absolute set point 6=enable logic on diff. set point 7= independent op. (cir. 1+cir. 2) 8= control on higher probe value 9= control on lower probe value 10= control set point from B2 11= auto heat/cool change from B2 Validity c0= 1, 2, 3, 4	0	0	11	-

Tab. 5.c

The second probe must be the same type as the first, as set by parameter c13. Nonetheless control can be performed on two different physical values, for example temperature-humidity using independent operation (c19=7) with combined active probe (e.g. CAREL DPWC\*) with two 4 to 20 mA outputs. For the explanation of the types of control based on parameter c19, see the chapter on "Control".

5.3 Standard operating modes (parameters St1,St2,c0,P1,P2,P3)

The controller can operate in 9 different modes, selected by parameter c0. The basic modes are "direct" and "reverse". In "direct" mode, the output is activated if the value measured is greater than the set point plus a differential. In "reverse" mode the output is activated if the temperature is less than the set point plus a differential. The other modes are a combination of these, with possibility of 2 set points (St1 & St2) and 2 differentials (P1 & P2) based on the mode, "direct" or "reverse", or the status of digital input 1. Other modes include "dead zone" (P3), "PWM" and "alarm". The number of outputs activated depends on the model (V/W/Z=1,2,4 relay outputs, A=4 SSR outputs, B/E=1/2 analogue outputs and 1/2 relay outputs). Selecting the correct operating mode is the first action to be performed when the default configuration, i.e. "reverse" operation, is not suitable for the application in question. For the description of "timer" operation see paragraph 5.6.1 (dependence parameter=15)

Par.	Description	Def	Min	Max	UoM
St1	Set point 1	20	c21	c22	°C (°F)
St2	Set point 2	40	c23	c24	°C (°F)
c0	1= direct 2= reverse 3= dead zone 4= PWM 5= alarm 6= direct/reverse from DI1 7= direct/direct from DI1 8= reverse/reverse from DI1 9= direct/reverse with separate set point	2	1	9	-
P1	Set point differential 1	2	0.1	50	°C (°F)
P2	Set point differential 2	2	0.1	50	°C (°F)
P3	Dead zone differential	2	0	20	°C (°F)
P1	Set point differential 1	2 (3,6)	0.1(0,2)	99,9 (179)	°C (°F)
P2	Set point differential 2	2 (3,6)	0.1(0,2)	99,9 (179)	°C (°F)
P3	Dead zone differential	2 (3,6)	0 (0)	99,9 (179)	°C (°F)
c21	Minimum value of set point 1	-50	-50	c22	°C (°F)
c22	Maximum value of set point 1	60	c21	150	°C (°F)
c21	Minimum value of set point 1	-50	-199	c22	°C (°F)
		(-58)	(-199)		
c22	Maximum value of set point 1	110	c21	800 (800)	°C (°F)
		(230)			
c23	Minimum value of set point 2	-50	-50	c24	°C (°F)
c24	Maximum value of set point 2	60	c23	150	°C (°F)
c23	Minimum value of set point 2	-50	-199	c24	°C (°F)
		(-58)	(-199)		
c24	Maximum value of set point 2	110	c23	800 (800)	°C (°F)
		(230)			

Tab. 5.d

To be able to set c0, the value of c33 must be 0. If c33=1, changing c0 has no effect.

For the mode set to become immediately operational, the controller needs to be switched off an on again. Otherwise correct operation is not guaranteed.

The meaning of parameters P1 & P2 changes according to the operating mode selected. For example, in modes 1 & 2 the differential is always P1. P2, on the other hand, is the "reverse" differential in mode 6 and the "direct" differential in mode 9.

5.3.1 Mode 1: Direct c0=1

In "direct" operation the controller ensures the value being controlled (in this case the temperature) does not exceed the set point (St1). If it does, the outputs are activated in sequence. The activation of the outputs is distributed equally across the differential (P1). When the value measured is greater than or equal to St1+P1 (in proportional only operation), all the outputs are activated. Similarly, if the value measured starts falling, the outputs are deactivated in sequence. When reaching St1, all the outputs are deactivated.

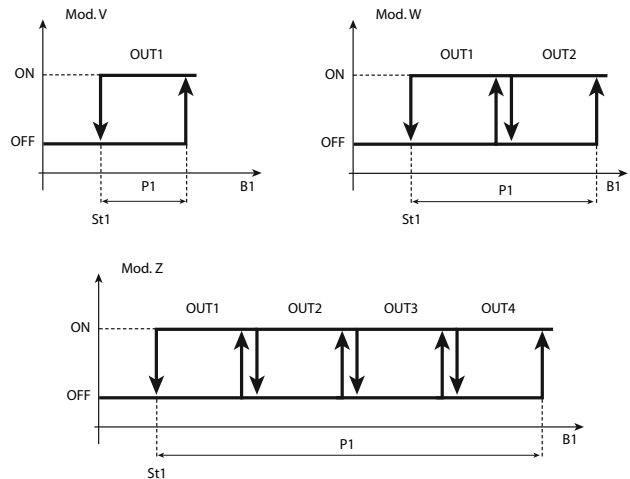

Fig. 5.c

Key	
St1	Set point 1
P1	Set point differential 1
OUT1/2/3/4	Output 1/2/3/4
B1	Probe 1

5.3.2 Mode 2: Reverse c0=2 (Default)

"Reverse" operation is similar to "direct" operation, however the outputs are activated when the value being controlled decreases, starting from the set point (St1). When the value measured is less than or equal to St1-P1 (in proportional only operation), all the outputs are activated. Similarly, if the value measured starts rising, the outputs are deactivated in sequence. When reaching St1, all the outputs are deactivated.

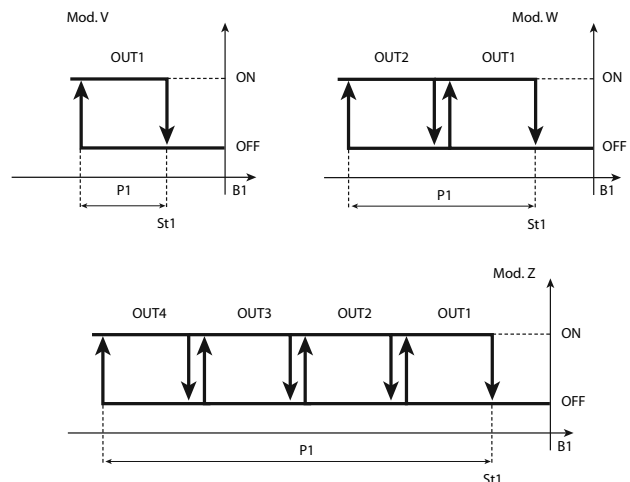

Fig. 5.d

Key	
St1	Set point 1
P1	Set point differential 1
OUT1/2/3/4	Output 1/2/3/4
B1	Probe 1



**5.3.3 Mode 3: Dead zone c0=3**

The aim of this control mode is to bring the measured value within an interval around the set point (St1), called the dead zone. The extent of the dead zone depends on the value of parameter P3. Inside the dead zone, the controller does not activate any outputs, while outside it works in "direct" mode when the temperature is increasing and in "reverse" mode when it is decreasing. According to the model used, there may be one or more outputs in "direct" and "reverse" modes. These are activated or deactivated one at a time, as already described for modes 1 & 2, according to the value measured and the settings of St1, P1 and P2.

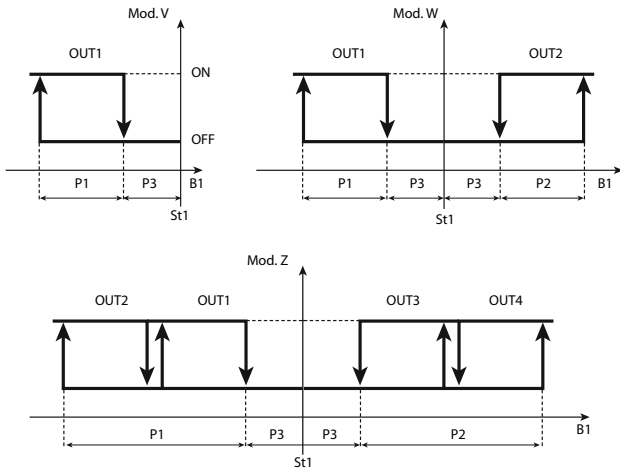

Fig. 5.e

Key	
St1	Set point 1
P1/P2	"Reverse"/"direct" differential
P3	Dead zone differential
OUT1/2/3/4	Output 1/2/3/4
B1	Probe 1

When the controller only has 1 output, it works in "reverse" mode with dead zone.

**5.3.4 Mode 4: PWM c0=4**

The control logic in PWM mode uses the dead zone, with the outputs activated based on pulse width modulation (PWM). The output is activated in a period equal to the value of parameter c12 for a variable time, calculated as a percentage; the ON time is proportional to the value measured by B1 inside the differential. For small deviations, the output will be activated for a short time. When exceeding the differential, the output will be always on (100% ON). PWM operation thus allows "proportional" control of actuators with typically ON/OFF operation (e.g. electric heaters), so as to improve temperature control. PWM operation can also be used to give a modulating 0 to 10 Vdc or 4 to 20 mA control signal on IR33 (DN33) Universal models A, D with outputs for controlling solid state relays (SSR). In this case, the accessory code CONV0/10A0 needs to be connected to convert the signal. In PWM operation, the "direct"/"reverse" icon flashes.

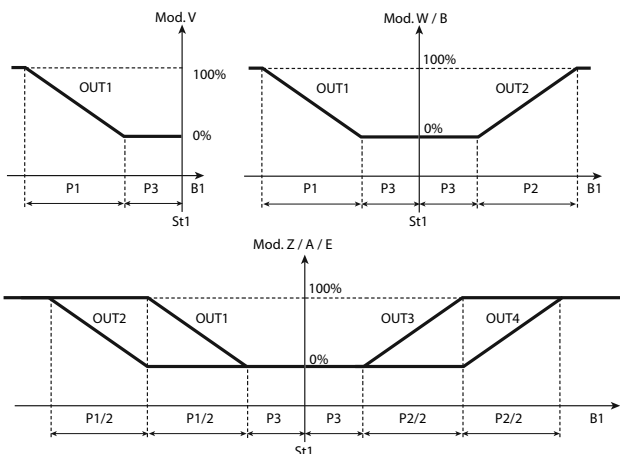

Fig. 5.f

Key	
St1	Set point 1
P1/P2	"Reverse"/"direct" differential
P3	Dead zone differential
OUT1/2/3/4	Output 1/2/3/4
B1	Probe 1

When the controller only has 1 output, it works in "reverse" mode with dead zone.

⚠ PWM mode should not be used with compressors or other actuators whose reliability may be affected by starting/stopping too frequently. For relay outputs, parameter c12 should not be set too low, so as to not compromise the life of the component.

**5.3.5 Mode 5: Alarm c0=5**

In mode 5, one or more outputs are activated to signal a probe disconnected or short-circuited alarm or a high or low temperature alarm. Models V and W only have one alarm relay, while model Z has two: relay 3 is activated for general alarms and for the low temperature alarm, relays 4 is activated for general alarms and for the high temperature alarm. The activation of the alarm relay is cumulative to the other signals in the other operating modes, that is, alarm code on the display and audible signal. For models W & Z, the relays not used to signal the alarms are used for control, as for mode 3 and shown the following diagrams. This operation mode is not suitable for the models B and E.

The parameters corresponding to probe 2 become active with independent operation (c19=7).

Par.	Description	Def	Min	Max	UOM
P25	Low temp. alarm threshold probe 1 P29= 0, P25= 0: threshold disabled P29= 1, P25= -50: threshold disabled	-50 (-58)	-50 (-58)		°C (°F)
P26	High temp. alarm threshold probe 1 P29= 0, P26= 0: threshold disabled P29= 1, P26= 150: threshold disabled	150 (302)	P25 (302)	150 (302)	°C (°F)
P27	Alarm differential on probe 1	2 (3,6)	0(0)	50(90)	°C (°F)
P25	Low alarm threshold on probe 1 P29= 0, P25= 0: threshold disabled P29= 1, P25= -199: threshold disabled	-50 (-58)	-199 (-199)	P26	°C (°F)
P26	High alarm threshold on probe 1 P29= 0, P26= 0: threshold disabled P29= 1, P26= 800: threshold disabled	150 (302)	P25 (302)	800 (800)	°C (°F)
P27	Alarm differential on probe 1	2 (3,6)	0(0)	99,9 (179)	°C (°F)
P28	Alarm delay time on probe 1(*)	120	0	250	min(s)
P29	Type of alarm threshold 0= relative; 1= absolute.	1	0	1	-
P30	Low temp. alarm threshold probe 2 if P34= 0, P30= 0: threshold disabled if P34= 1, P30= -50: threshold disabled	-50 (-58)	-50 (-58)	P31	°C (°F)
P31	High temp. alarm threshold probe 2 if P34= 0, P31= 0: threshold disabled if P34= 1, P31= 150: threshold disabled	150 (302)	P30 (302)	150 (302)	°C (°F)
P32	Alarm differential on probe 2	2 (3,6)	0(0)	50(90)	°C (°F)
P30	Low alarm threshold on probe 2 if P34= 0, P30= 0: threshold disabled if P34= 1, P30= -199: threshold disabled	-50 (-58)	-199 (-199)	P31	°C (°F)
P31	High alarm threshold on probe 2 if P34= 0, P31= 0: threshold disabled if P34= 1, P31= 800: threshold disabled	150 (302)	P30 (302)	800 (800)	°C (°F)
P32	Alarm differential on probe 2	2 (3,6)	0(0)	99,9 (179)	°C (°F)
P33	Alarm delay time on probe 2(*)	120	0	250	min(s)
P34	Type of alarm threshold on probe 2 0= relative; 1= absolute.	1	0	1	-

Tab. 5.e

(\*) In the event of alarms from digital input, the unit of measure is seconds (s).

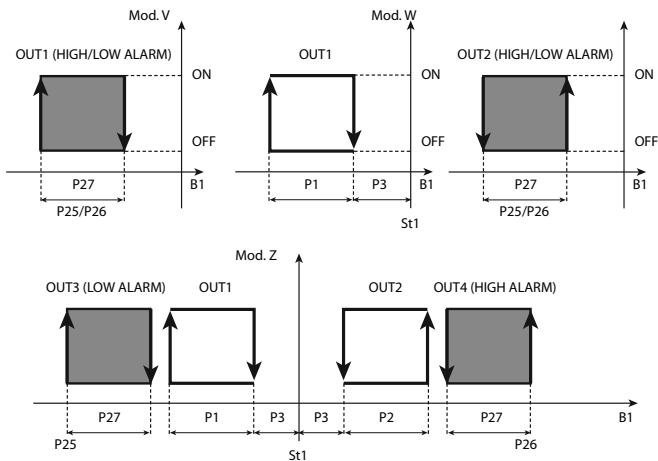

Fig. 5.g

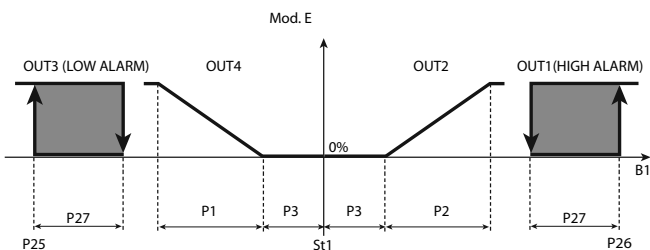

Fig. 5.h

Key	
St1	Set point 1
P1	"Reverse" differential
P2	"Direct" differential
P3	Dead zone differential
P27	Alarm differential
OUT1/2/3/4	Output 1/2/3/4
B1	Probe 1

Parameter P28 represents the "alarm activation delay", in minutes; with reference to probe 1 the low temperature alarm (E05) is activated only if the temperature remains lower than the value of P25 for a time greater than P28. The alarm may be relative or absolute, depending on the value of parameter P29. In the former case (P29=0), the value of P25 indicates the deviation from the set point and thus the activation point for the low temperature alarm is: set point - P25. If the set point changes, the activation point also changes automatically. In the latter case (P29=1), the value of P25 indicates the low temperature alarm threshold. The low temperature alarm active is signalled by the buzzer and code E05 on the display. The same applies to the high temperature alarm (E04), with P26 instead of P25. Likewise parameters P30 to P34 refer to probe 2.

Alarm set point relative to working set point P29=0

	Low alarm		High alarm	
	Enable	Disable	Enable	Disable
Probe 1 (P29=0)	St1-P25	St1-P25 +P27	St1 +P26	St1+P26 -P27
Probe 2 (P34=0)	St2 -P30	St2 -P30 +P32	St2 +P31	St2 +P31 -P32

Tab. 5.f

Absolute alarm set point P29=1

	Low alarm		High alarm	
	Enable	Disable	Enable	Disable
Probe 1 (P29=1)	P25	P25+P27	P26	P26-P27
Probe 2 (P34=1)	P30	P30+P32	P31	P31-P32

Tab. 5.g

⚠ The low and high temperature alarms are automatically reset; if there is an alarm active on the control probe, these alarms are deactivated and monitoring is reinitialised.

🔊 When alarms E04/E15 and E05/E16 are active, the buzzer can be muted by pressing Prg/mute. The display remains active.

### 5.3.6 Mode 6: Direct/reverse with changeover from DI1 c0=6

The controller operates in "direct" mode based on St1 when digital input 1 is open, in "reverse" based on St2 when it is closed.

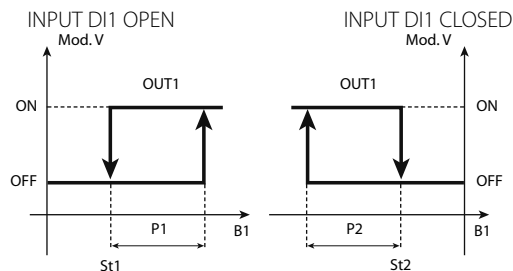

Fig. 5.i

Key

St1/St2	Set point 1/2
P1	"Direct" differential
P2	"Reverse" differential
OUT1	Output 1
B1	Probe 1

For models W & Z the activations of the outputs are equally distributed inside the differential set (P1/P2).

⚠ Parameter c29 is not active in mode 6.

### 5.3.7 Mode 7: Direct with set point & differential, changeover from DI1 c0=7

The controller always operates in "reverse" mode, based on St1 when digital input 1 is open and based on St2 when it is closed.

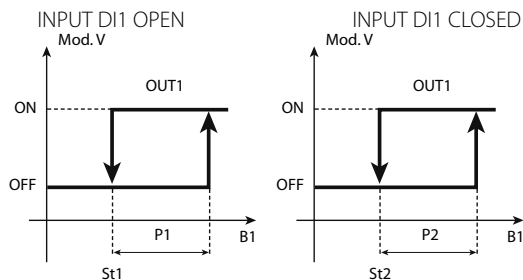

Fig. 5.j

Key

St1/St2	Set point 1/2
P1	"Direct" differential St1
P2	"Direct" differential St2
OUT1	Output 1
B1	Probe 1

For models W & Z the activations of the outputs are equally distributed across the differential (P1/P2).

⚠ Parameter c29 is not active in mode 7.

### 5.3.8 Mode 8: Reverse with set point & differential, changeover from DI1 c0=8

The controller always operates in "reverse" mode, based on St1 when digital input 1 is open and based on St2 when it is closed.

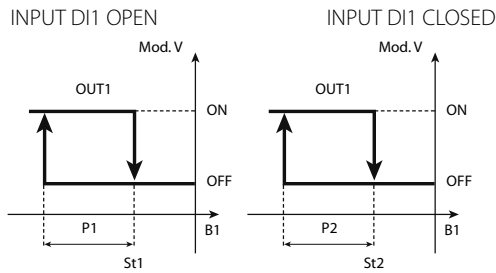

Fig. 5.k

St1/St2	Set point 1/2
OUT1	Output 1
P1	"Reverse" differential
B1	Probe 1
P2	"Reverse" differential

For models W & Z the activations of the outputs are equally distributed across the differential (P1/P2).

⚠ Parameter c29 is not active in mode 8.

### 5.3.9 Mode 9: Direct/reverse with two set points c0=9

In this mode, available only on the models with 2 or 4 outputs, half of the outputs are active in "direct" mode and half in "reverse". The unique aspect is that there are no restrictions in the setting of the set point for the two actions, therefore it is like having two independent controllers that work with the same probe.

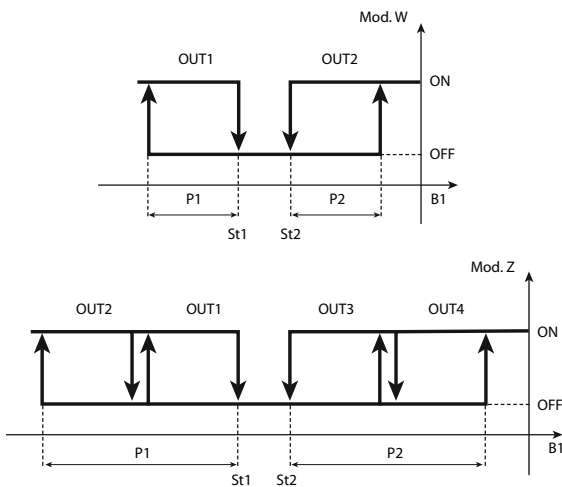

Fig. 5.l

St1/St2	Set point 1/2
P1	"Reverse" differential St1
P2	"Direct" differential St2
OUT1/2/3/4	Output 1/2/3/4
B1	Probe 1

⚠ Parameter P29 is not active in mode 9 (the alarm is only based on an absolute threshold).

## 5.4 Validity of control parameters (parameters St1,St2,P1,P2,P3)

The parameters that define the operating mode have the validity defined in the table below:

Parameter	Validity	Note
St1	All modes	
St2	c0 = 6,7,8,9 or any value of c0 if c33 = 1 (special operation). If c19=2, 3 or 4, St2 is used in compensation. If c19=2, 3, 4, 7, 11, St2 is used for control. If c19=7 St2 is the set point for circuit 2..	In special operation (c33=1), St2 is set on the keypad in all modes, but is only active for outputs with dependence equal to 2.
P1	All modes	
P2	c0=3,4,5,6,7,8,9 Active also in other modes if c33=1 (special operation) or c19=4.	note that in modes 3, 4 and 5, P2 is the differential of the "direct" action and refers to St1.
P3	c0=3,4 & 5 When c0=5 models W & Z only	

Tab. 5.h

## 5.5 Selecting the special operating mode

Par.	Description	Def	Min	Max	UoM
c33	Special operation 0= Disabled 1= Enabled	0	0	1	-

Tab. 5.i

Parameter c33 offers the possibility to create custom operating logic, called special operation. The logic created may be a simple adjustment or a complete overhaul of one of the nine modes. In any case, note that:

- Modes 1, 2, 9: do not consider the dead zone P3 nor the changeover in logic from digital input
- Modes 3, 4, 5: enable the dead zone differential P3. No changeover in logic from digital input.
- Mode 6: does not consider the differential P3. The changeover of digital input 1 means the outputs consider set point 2 rather than set point 1. The direct/reverse logic will be inverted. For outputs with "dependence"=2, only the changeover in logic is active, that is, the closing of the digital contact maintains "dependence"=2 (St2) but inverts the logic, exchanging the signs for "activation" and "differential/ logic" (see the explanation below).
- Modes 7, 8: do not consider the dead zone P3. For outputs with "dependence"=1, the digital input only shifts the reference from St1/P1 to St2/P2, maintaining the control logic ("activation" "differential/ logic" do not change sign). The digital input does not have any influence on the other control outputs, that is, with "dependence"=2 and alarms.

👉 For the explanation of the "dependence", "activation" and "differential/ logic" parameters, see the following paragraphs.

⚠ Before selecting c33=1: for starting modes other than c0=2 (default), this must be set before enabling special operation (c33=1): the change to c0 must be saved by pressing **Prg** mute.

⚠ When c33=1, changing c0 no longer affects the special parameters. That is, c0 can be set however the special parameters (from c34 to d49) and the typical functions remain frozen in the previous mode with c33=1: while the parameters can be set individually, the typical functions cannot be activated. In conclusion, only after having set and saved the starting mode can the parameters be edited again and c33 set to 1.

⚠ If the mode needs to be changed after c33 has been set to 1, first return c33=0, press **Prg** mute to confirm, set the required mode and save the change **Prg** mute, then return to special operation with c33=1. Setting c33 from 1 to 0, the controller cancels all changes to the "special parameters", which return to the values dictated by c0..

## 5.6 Special operating modes

When c33=1, 44 other parameters become available, the so-called special parameters. The special parameters are used to completely define the operation of each individual output available on the controller. In normal operation, that is, choosing the operating mode using parameter "c0", these parameters are automatically set by the controller. When c33=1, the user can adjust these settings using the 8 parameters that define each individual output:

- dependence
- type of output
- activation
- differential/logic
- activation restriction
- deactivation restriction
- maximum/minimum modulating output value (PWM or 0-10Vdc)
- cut-off
- speed up time
- type of forcing

### Special parameters and correspondence with the various outputs

	OUT1	OUT2	OUT3	OUT4
Dependence	c34	c38	c42	c46
Type of output	c35	c39	c43	c47
Activation	c36	c40	c44	c48
Differential/logic	c37	c41	c45	c49
Activation restriction	d34	d38	d42	d46
Deactivation restriction	d35	d39	d43	d47
Minimum modulating output value	d36	d40	d44	d48
Maximum modulating output value	d37	d41	d45	d49
Cut-off	F34	F38	F42	F46
Speed up time	F35	F39	F43	F47
Type of forcing	F36	F40	F44	F48

Tab. 5.j

The default and minimum and maximum values of the special parameters depend on the number and type of outputs on the model.

Before setting parameter c33, make sure the required starting mode - param.c0 - has been set.

When c33=1, the special parameters are not visible and cannot be set to achieve the required operation.

When setting a special parameter, always check the coherence of the other 43 special parameters with regards to the type of operation set.

### 5.6.1 Dependence (parameters c34,c38,c42,c46)

This is the parameter that determines the specific function of each output.

It links an output to a set point (control output) or a specific alarm (alarm output). Parameter c34, c38, c42, c46 correspond to outputs 1, 2, 3, 4 respectively and the field of selection is from 0 to 29.

Circuit 1 is the control circuit when independent operation is not activated, in which case control operates on circuits 1 and 2. If independent operation is not activated but one of the settings relating to the alarm on circuit 2 is selected, the alarm is signalled on the display but has no effect.

**Dependence = 0:** the output is not enabled. This is the value set on versions V and W for the outputs that are not available (that is 2, 3 & 4 for version V, 3 & 4 for version W).

**Dependence = 1 & 2:** the output is the control output and refers to St1/P1/PID1 and St2/P2/PID2 respectively. In the subsequent special parameters, "type of output", "activation" and "differential/logic", the operation of the output can be defined completely.

**Dependence = 3 to 14 and 19 to 29:** the output is associated with one or more alarms. See the chapter on "Alarms" for the complete list.

**Dependence = 15:** "timer" operation. The output becomes independent of the measurement, set points, differentials, etc. and continues to switch periodically at a period=c12 (cycle time). The ON time (T\_ON) is defined by the "activation" parameter as a percentage of the set cycle time. If an alarm occurs or the controller is switched OFF, "timer" operation is deactivated. For further information, see the description of the parameters "type of output", "activation".

**Dependence = 16:** the output is the control output: the association St1/P1 and St2/P2 depends on the status of digital input 1. If the input is

open, reference will be to St1/P1; if the input is closed, reference will be to St2/P2. Changing the set point also reverses the operating logic.

**Dependence = 17:** the output is the control output: the association St1/P1 and St2/P2 depends on the status of digital input 1. If the input is open, reference will be to St1/P1; if the input is closed, reference will be to St2/P2. Changing the set point maintains the operating logic.

**Dependence = 18:** a digital output can be selected to signal controller ON/OFF status (controller ON/OFF in relation to the status of the digital input: c29, c30=4). If the controller is OFF the relay is NC, if the controller is ON the relay is NO. The alarm outputs are also deactivated when OFF.

DEPENDENCE VALUE	OUTPUT	ALARM RELAY IN NORMAL CONDITIONS
0	not active	-
1	relative to St1	-
2	relative to St2	-
3	active with alarm from digital input	OFF
4	active with alarm from digital input	ON
5	active with serious and "High" alarms (E04)	OFF
6	active with serious and "High" alarms (E04)	ON
7	active with serious and "Low" alarms (E05)	OFF
8	active with serious and "Low" alarms (E05)	ON
9	active with "Low" alarm (E05)	OFF
10	active with "Low" alarm (E05)	ON
11	active with "High" alarm (E04)	OFF
12	active with "High" alarm (E04)	ON
13	active with serious alarm	OFF
14	active with serious alarm	ON
15	TIMER operation	-
16	operation of output dependent on status of digital input 1 with reversal of operating logic	-
17	operation of output dependent on status of digital input 1 with operating logic maintained	-
18	ON/OFF status signal	-
19	Generic alarm circuit 2 (relay OFF)	OFF
20	Generic alarm circuit 2 (relay ON)	ON
21	Serious alarm circuit 2 and E15 (relay OFF)	OFF
22	Serious alarm circuit 2 and E15 (relay ON)	ON
23	Serious alarm circuit 2 and E16 (relay OFF)	OFF
24	Serious alarm circuit 2 and E16 (relay ON)	ON
25	Alarm E16 (relay OFF)	OFF
26	Alarm E16 (relay ON)	ON
27	Alarm E15 (relay OFF)	OFF
28	Alarm E15 (relay ON)	ON
29	Alarm E17 (relay OFF)	OFF

Tab. 5.k

Alarm relay OFF = output normally deactivated; energised with alarm.

Alarm relay ON = output normally activated; de-energised with alarm.

When ON the relay is normally active: it is deactivated with an alarm.

This is an intrinsic safety feature, as the contact switches, and thus the alarm is signalled, even if there is a power failure, serious faults on the controller or a data memory alarm (E07/E08)

In the models B and E, for the outputs 2 and 4, the dependence may be only 0, 1, 2.

### 5.6.2 Type of output (parameters c35,c39,c43,c47)

The parameter is active only if the output is the control output ("dependence"=1,2,16,17) or TIMER ("dependence"=15).

Type of output=0: the output is on/off.

Type of output=1: the output is PWM, "timer".

"Timer" operation is combined with "dependence"=15.

In the models B and E, the output type will always be 0 to 10 Vdc independently from the value of this parameter.

### 5.6.3 Activation (parameters c36,c40,c44,c48)

The parameter is active only if the output is the control output ("dependence"=1,2,16,17) or TIMER ("dependence"=15).

If "dependence"=1, 2, 16 and 17 it represents, for ON/OFF operation, the activation point of the output while, for PWM operation and 0 to 10 V, it indicates the point where the output has the maximum value. The "activation" parameter is expressed as a percentage, from -100 to +100 and refers to the operating differential and the set point that the output refers to. If the output refers to St1 ("dependence"=1), "activation" is relative to the percentage value

of P1; if the output refers to St2 ("dependence"= 2), "activation" is relative to the percentage value of P2.

If the value of "activation" is positive, the activation point is to the 'right' of the set point, while if negative it is to the 'left'.

► If "dependence"=15 & "type of output"=1, the "activation" parameter defines the ON time as a percentage of the period (c12); in this case, "activation" must only have positive values (1 to 99).

Example 1:

The figure below shows the activation points on a controller with 2 outputs, with the following parameters:

St1=10, St2=20, P1=P2=6

OUT1 (point A): "dependence"=c34=1, "activation"= c36=-100;

OUT2 (point B): "dependence"=c38=2, "activation"= c40= +75.

A=4; B=24.5

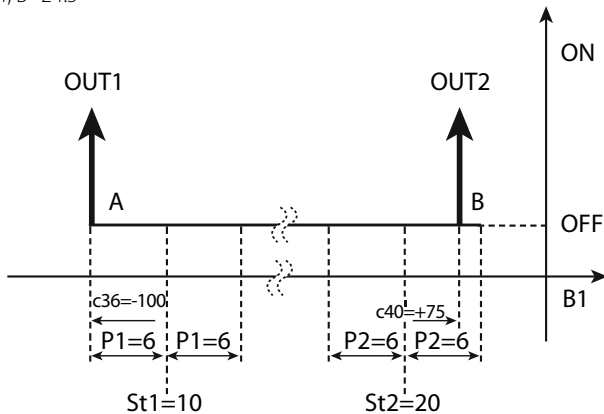

Fig. 5.m

Key	
St1/2	Set point 1/2
P1	Differential for output 1
P2	Differential for output 2
OUT1/2	Output 1/2
B1	Probe 1

Example 2

A "timer" output is selected with "dependence"=15, "type of output"=1 and "activation" (ON percentage) between 1 and 99, with a cycle time set by c12. Below OUT1 and OUT2 are proposed as "timer" outputs with c36 greater than c40, example:

OUT1: c34=15, c35=1, c36=50; OUT2: c38=15, c39=1, c40=25.

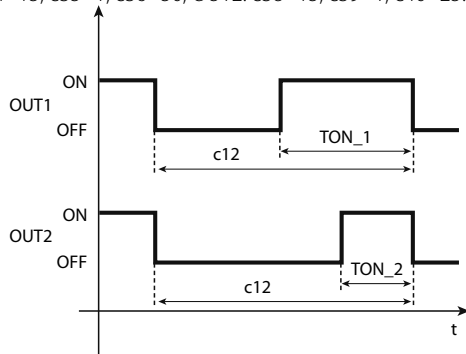

Fig. 5.n

Key	
t	time
c12	cycle time
OUT1/2	Output 1/2
TON_1	(c36*c12)/100
TON_2	(c40*c12)/100

### 5.6.4 Differential/logic ( parameters c37,c41,c45,c49)

The "differential/logic" parameter is only active if the output is the control output ("dependence"=1,2,16,17). Like the "activation" parameter, it is expressed as a percentage and is used to define the hysteresis of the output, that is, for ON/OFF operation, the deactivation point of the output or, for PWM operation, the point where the output has the minimum value (ON time =0). If the output refers to St1 ("dependence"=1), "differential/logic" is relative to the percentage value of P1; if the output refers to St2 ("dependence"= 2), "differential/logic" is relative to the percentage value of P2. If the value of "differential/logic" is positive, the deactivation point is

greater than the activation point and "reverse" logic is created. If the value of "differential/logic" is negative, the deactivation point is less than the activation point and "direct" logic is created. Together with the previous "activation" parameter, this identifies the proportional control band.

Example 3 completes example 1, adding the deactivation points. For the first output "reverse" operation is required, and the differential P1; for the second, "direct" logic and the differential equal to half of P2.

The parameters are :

Output 1 : "differential/logic"=c37=+100 (A)

Output 2 : "differential/logic"=c41=-50 (B)

A'=10; B'=21.5

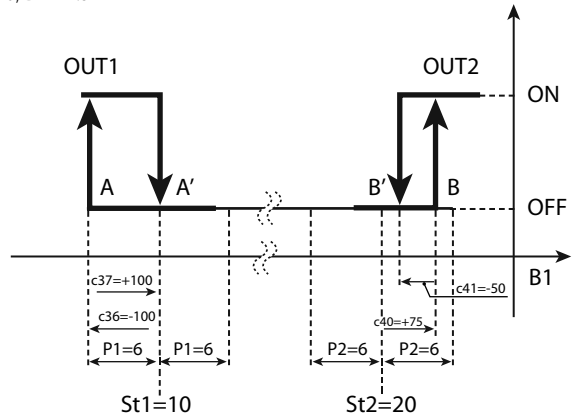

Fig. 5.o

Key	
St1/2	Set point 1/2
c36/c40	Activation of output 1/2
c37/c41	Differential/logic for output 1/2
OUT1/2	Output 1/2
P1	Set point differential 1
P2	Set point differential 2
B1	Probe 1

As an example, reversing the values of "differential/logic", the new deactivation points are as follows

Output 1 : "differential/logic"=c37=-50(A')

Output 2 : "differential/logic"=c41=+100 (B'')

A'=1; B''=30.5

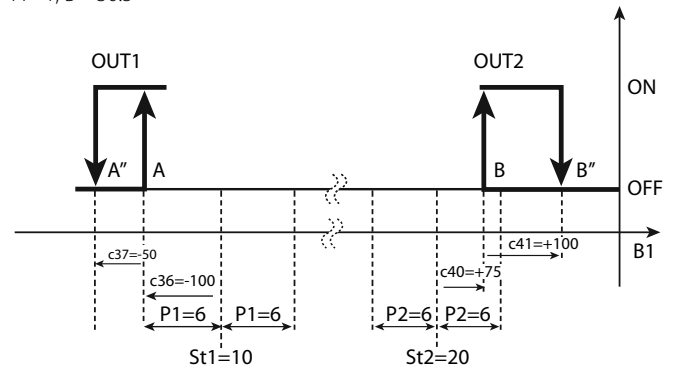

Fig. 5.p

### 5.6.5 Activation restriction (par. d34,d38,d42,d46)

In normal operating conditions, the activation sequence should be as follows: 1,2,3,4. However, due to minimum on/off times or times between successive activations, the sequence may not be observed. By setting this restriction, the correct sequence is observed even when timers have been set. The output with the activation restriction set to 'x' (1,2,3) will only be activated after the activation of output 'x'. The output with the activation restriction set to 0 will be activated irrespective of the other outputs.

**5.6.6 Deactivation restriction (par. d35,d39,d43,d47)**

In normal operating conditions, the deactivation sequence should be as follows: 4,3,2,1. However, due to minimum on/off times or times between successive activations, the sequence may not be observed. By setting this restriction, the correct sequence is observed even when timers have been set. The output with the deactivation restriction set to 'x' (1,2,3) will only be deactivated after the deactivation of output 'x'. The output with the deactivation restriction set to 0 will be deactivated irrespective of the other outputs.

**5.6.7 Minimum modulating output value (parameters d36,d40,d44,d48)**

Valid if the output is the control output and the "type of output"=1, that is, the output is PWM or in case of 0 to 10Vdc output. The modulating output can be limited to a relative minimum value.

Example of **proportional** control: "reverse" mode with  $St1 = 20^{\circ}C$  and  $P1 = 1^{\circ}C$ . If only one modulating output is used with a differential of  $1^{\circ}C$ , setting this parameter to 20 (20%) will mean the output is only activated when the temperature measured deviates more than 20% of the set point, that is, with values less than  $19.8^{\circ}C$  as shown in the figure.

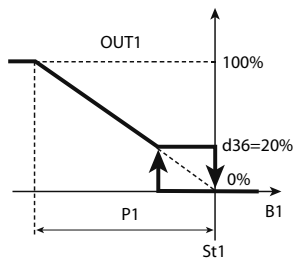

Fig. 5.q

Key			
St1	Set point 1	P1	"Reverse" differential
OUT1	Output 1	d36	Min. value of modulating output 1
B1	Probe 1		

**5.6.8 Maximum modulating output value (parameters d37,d41,d45,d49)**

Valid if the output is the control output and the "type of output"=1, that is, the output is PWM or in case of 0 to 10Vdc output. The modulating output can be limited to a relative maximum value.

Example of **proportional** control: "reverse" mode with  $St1 = 20^{\circ}C$  and  $P1 = 1^{\circ}C$ . If only one modulating output is used with a differential of  $1^{\circ}C$ , setting this parameter to 80 (80%) will mean the output is only activated when the temperature measured deviates more than 80% of the set point, that is, with values less than  $19.2^{\circ}C$ . After this value the output will remain constant, as shown in the figure.

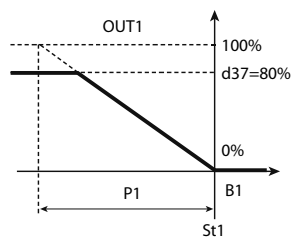

Fig. 5.r

Key		
St1	Set point 1	
P1	"Reverse" differential	
d37	Maximum value of modulating output 1	
OUT1	Output 1	
B1	Probe 1	

**5.6.9 Modulating output cut-off (parameters F34,F38, F42, F46)**

These parameters are useful when needing to apply a minimum voltage value for operation of an actuator. They enable operation with a minimum limit for the PWM ramp and 0 to 10Vdc analogue output.

Example: control with two outputs, the first(OUT1) ON/OFF and the second (OUT2) 0 to 10Vdc; "minimum value of the modulating output" for output 2= 50 (50% of the output), d40=50.

CASE 1 : F38 = 0 Cut off operation

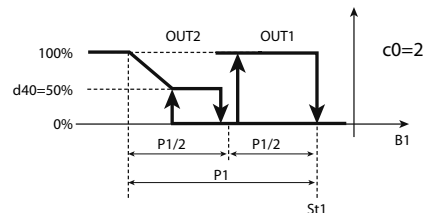

Fig. 5.s

CASE 2 : F38 = 1 Minimum speed operation

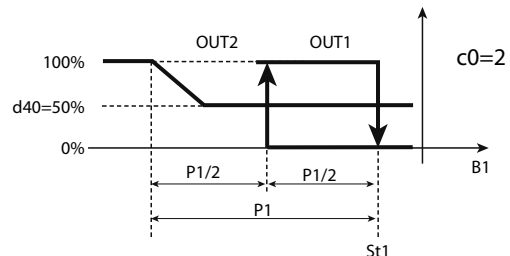

Fig. 5.t

⚠ When modulating output cut-off is enabled, the on (d34, d38, d42, d46) and off limits (d35, d39, d43, d47) must be set correctly.

**5.6.10 Modulating output speed up time (parameters F35, F39, F43, F47)**

These parameters are used to activate the modulating output to the maximum value allowed (parameters d37, d41, d45, d49) for a set time, starting from the instant the output is activated. Setting it to 0 disables the speed up function.

**5.6.11 Override outputs (parameters F36, F40, F44, F48)**

These parameters determine how the relay or modulating control output is overridden, activated by digital input (c29=6, c30=6). The effect on the output depends on whether the output is a relay or modulating.

Override output action		
TYPE OF OVERRIDE	RELAY OUTPUT	MODULATING OUTPUT
0	-	-
1	OFF respecting c6, c7	0%, 0 Vdc
2	ON	100%, 10 Vdc
3	-	minimum set (d36, d40, d44, d48)
4	-	maximum set (d37, d41, d45, d49)
5	OFF respecting c6, c7,d1, c8, c9	-

Tab. 5.I

### 5.7 Additional remarks on special operation

#### Dead zone P3

In **modes 3, 4 and 5** there is a dead zone defined by P3. The activation or deactivation points cannot be positioned inside the dead zone: if these are identified in the zone before and after the set point, the instrument automatically increases the hysteresis of the output involved by double the value of P3.

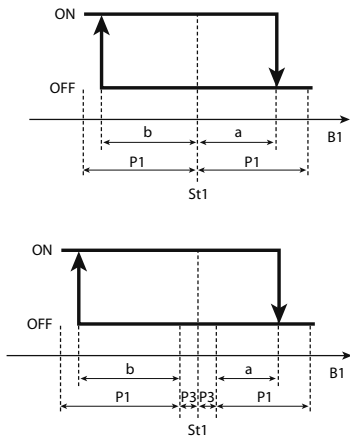

Fig. 5.u

The PWM (or analogue) outputs will follow the operation indicated in the figure. In practice, in the dead zone the output maintains the level of activation unchanged.

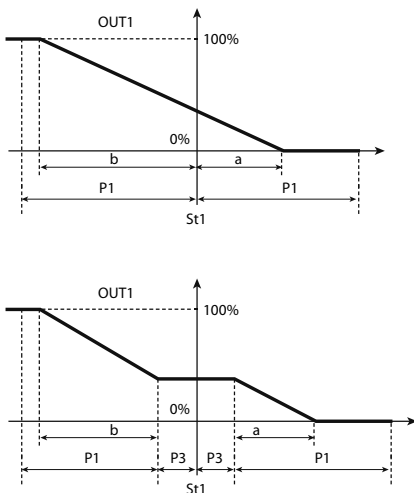

Fig. 5.v

**Mode 6** sees the outputs linked to St1 with "direct" logic ("activation" positive and "differential/logic" negative) when digital input 1 is open. The closing of digital input 1 forces the outputs to depend on St2 and P2, and the logic becomes "reverse", by inverting of sign of the "activation" and "differential/logic" parameters (reading the values of the parameters does not depend on the status of the digital input: these only change as regards the algorithm). When c33=1.

The outputs with dependence 16 will have the effect shown in the figure when ID1 switches.

DEPENDENCE= 16

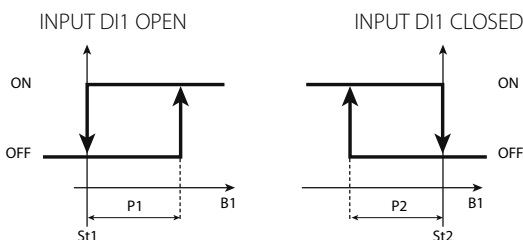

Fig. 5.w

**Modes 7 and 8.** The outputs with "dependence"=17 will have the effect shown in the figure when ID1 switches.

These modes in fact do not allow changes to the logic. The alarm outputs ("dependence"=3 to 14, 19 to 29) do not depend on digital input 1. DEPENDENCE= 17

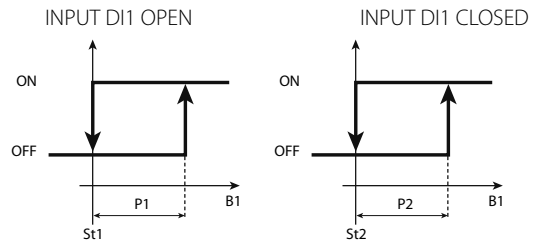

Fig. 5.x

**Modes 1 & 2** in differential operation (c19=1).

Similarly to the previous case, when c33=1 the outputs with "dependence" = 2 no longer have the compensation function.

**Modes 1 and 2** with "compensation" operation (c19=2, 3, 4).

Like the previous case, when c33=1 the compensation function is no longer active on outputs with "dependence" setting 2.

### 5.8 Outputs and inputs

#### 5.8.1 Relay digital outputs (par. c6,c7,d1,c8,c9,c11)

The parameters in question concern the minimum on or off times of the same output or different outputs, so as to protect the loads and avoid swings in control.

⚠ For the times set to become immediately operational, the controller needs to be switched off and on again. Otherwise, the timers will become operational when the controller is next used, when the internal timer is set.

#### 5.8.2 Relay output protector (parameters c7,c8,c9)

Par.	Description	Def	Min	Max	UoM
c7	Minimum time between activations of the same relay output Validity: c0 ≠ 4	0	0	15	min
c8	Minimum relay output off time Validity: c0 ≠ 4	0	0	15	min
c9	Minimum relay output on time Validity: c0 ≠ 4	0	0	15	min

Tab. 5.m

- c9 defines the minimum time the output is activated, regardless of the request.
- c8 defines the minimum time the output is deactivated, regardless of the request
- c7 establishes the minimum time between two following activations of the same output.

#### 5.8.3 Other relay output protectors (parameters c6,d1)

Par.	Description	Def	Min	Max	UoM
c6	Delay between activations of 2 different relay outputs Validity: c0 ≠ 4	5	0	255	s
d1	Minimum time between deactivations of 2 different relay outputs Validity: c0 ≠ 4	0	0	255	s

Tab. 5.n

- c6 establishes the minimum time that must elapse between successive activations of two different relay outputs. Activation is delayed to avoid overloads on the line due to starting devices too close together or simultaneously.
- d1 establishes the minimum time that must elapse between deactivations of two different outputs.

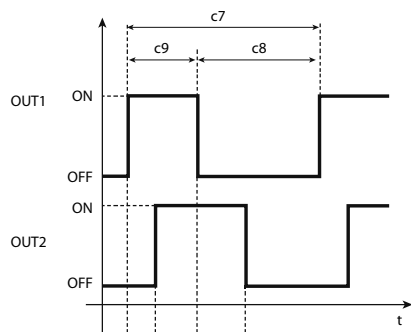

Fig. 5.y

Key  
t= time

⚠ c6, c7, c8, c9 & d1 are not operative for the PWM outputs.

**5.8.4 Rotation (parameter c11)**

This allows the control outputs to change activation and deactivation priority: based on the requests dictated by the controller, the output that has been active longest is deactivated, or the output that has been off longest is activated.

Par.	Description	Def	Min	Max	UM
c11	Output rotation 0=Rotation not active 1=Standard rotation (on 2 or 4 relays) 2=Rotation 2+2 3=Rotation 2+2 (COPELAND) 4=Rotation of outputs 3 & 4, not 1 & 2 5=Rotation of outputs 1 & 2, not 3 & 4 6=Separate rotation of pairs (between each other) and 3,4 7= Rotation of outputs 2,3,4, not 1 Validity : c0=1,2,7,8 & c33=0 8= Rotation of outputs 1 and 3, not 2 and 4 Validity : c0=1, 2, 7, 8 and c33= 0	0	0	7	-

Tab. 5.o

Rotation 2+2 on 4 outputs (c11=2) has been designed to manage capacity-controlled compressors. Outputs 1 and 3 activate the compressors, outputs 2 and 4 the capacity control valves. Rotation occurs between outputs 1 and 3, while the valves are energised (relays ON) to allow the operation of the compressors at maximum capacity. Valve 2 is linked to output 1 and valve 4 to output 3.

The rotation 2+2 DWM Copeland on 4 outputs (c11=3) is similar to the previous rotation, with the opposite logic for managing the valves. The valves are in fact normally energised (capacity controlled compressor) and are de-energised (relays OFF) when the compressor needs to operate at full power. A normal activation sequence is:

- 1 off, 2 off, 3 off, 4 off
- 1 on, 2 on, 3 off, 4 off
- 1 on, 2 off, 3 off, 4 off
- 1 on, 2 off, 3 on, 4 on
- 1 on, 2 off, 3 on, 4 off

As before, in this case too outputs 1 and 3 control the compressors, outputs 2 and 4 the corresponding solenoid valves.

- ▶ The parameter has no effect on controllers with 1 output.
- ▶ In the models with two outputs(W), rotation is standard even when c11=2 or 3;
- ▶ The connection in the 2+2 configuration is as follows: OUT1 = Comp. 1, OUT2 = Valve 1, OUT3 = Comp. 2, OUT4 = Valve 2.

⚠ Pay careful attention when programming the parameters, as the controller rotates the outputs according to the logic described above, regardless of whether these are control outputs (PWM) or alarm outputs. If there is at least one PWM or 0 to 10 Vdc output, rotation is never active, except for on DN/IR33 model E with c11=8..

Example a: if there are two alarm and two control outputs, rotation must be set so as to only rotate the control outputs.

Example b: to control a chiller with three compressors, rotation mode 7 can be set, reserving outputs 2, 3 & 4 for the compressors, while output 1 can be unconnected or used as an auxiliary output or alarm output.

**5.8.5 SSR (solid state relay) digital outputs**

When control is required using on one or more PWM outputs, the solution with relays becomes impractical if the changeover times are not quite high (at least 20 seconds), otherwise the life of the relays will be reduced. In these cases, solid state relays (SSR) can be used, managed according to the specific application.

**5.8.6 PWM cycle time (parameter c12)**

This represents the total time of the PWM cycle; in fact, the sum of the on time (tON) and the off time (tOFF) is constant and equal to c12. The ratio between ton and toff is established by the control error, that is, the deviation from the set point, referred (as a percentage) to the differential linked to the output. For further details, see mode 4.

Par.	Description	Def	Min	Max	UM
c12	PWM cycle time Validity: c0=4; In special operation c12 is active in any mode if "type of output"=1	20	0.2	999	s

Tab. 5.p

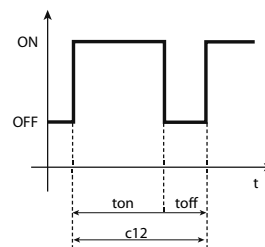

Fig. 5.z

Key  
t= Time

▶ As the action of PWM operation is modulating, PID control can be fully exploited, so that the value coincided with the set point or falls inside the dead zone.

▶ The minimum on time (ton) calculable and the maximum definition achievable for ton is 1/100 of c12(1%).

**5.8.7 0 to 10 Vdc analogue outputs**

When the application requires one or more 0 to 10Vdc analogue outputs, the following controllers should be used:

- IR33B7\*\*\*\* (1 relay + 1 x 0 to 10Vdc)
- IR33E7\*\*\*\* (2 relays + 2 x 0 to 10Vdc)
- DN33B7\*\*\*\* (1 relay + 1 x 0 to 10Vdc)
- DN33E7\*\*\*\* (2 relays + 2 x 0 to 10Vdc)

In this case too, the system operates with a voltage that ramps from 0 to 10Vdc.

**5.8.8 Analogue inputs**

See the start of the chapter, under the paragraph on "Probes".



**5.8.9 Digital inputs**

Parameter c29 establishes the function of digital input 1 if not already used in modes 6, 7 and 8 or in special operation (c33=1) with "dependence"=16 and 17. When set as an alarm input, that is, c29=1,2,3, one or more alarm outputs are activated based on the mode used (see mode 5), while the action on the control outputs is defined by c31 (see the chapter on "Alarms"). Parameter c30 has a similar meaning to c29 and refers to digital input 2.

**!** Circuit 1 is the control circuit when independent operation is not activated, in which case the controller works on both circuits 1 and 2. If independent operation is not activated, but one of the alarms relating to circuit 2 has been selected, the alarm has no effect on control and only the code is shown on the display.

Par.	Description	Def	Min	Max	UM
c29	Digital input 1 0= Input not active 1= Immediate external alarm, Automatic reset (circuit 1) 2= Immediate external alarm, Manual reset (circuit 1) 3= Delayed external alarm (P28), Manual reset (circuit 1) 4= ON/OFF control in relation to status of digital input 5= Activation/deactivation working cycle from button 6= Override outputs (circuit 1) 7= Signal only alarm E17, delayed (P33) 8= Signal only alarm E17, immediate 9= Immediate external alarm, automatic reset (circuit 2) 10= Immediate external alarm, manual reset (circuit 2) 11= Delayed external alarm (P33), Manual reset (circuit 2) 12= Override outputs (circuit 2) Validity: c0 other than 6,7, and if c33= 1 with "dependence"=16 and 17. In the event of alarms, the status of the relay depends on c31 or d31	0	0	5	-
c30	Digital input 2 See c29	0	0	5	-

Tab. 5.q

**c29= 0** Input not active

**c29= 1** Immediate external alarm with automatic reset (circuit 1)  
The alarm condition relates to the contact being open. When the alarm condition ceases (contact closes), normal control resumes and any alarm output is deactivated.

**c29= 2** Immediate external alarm with manual reset (circuit 1)  
The alarm condition relates to the contact being open. When the alarm condition ceases (contact closes), normal control does not resume automatically, and the audible signal, the alarm code E03 and any alarm output remain active. Control can start again only after a manual reset, that is, after pressing Prg/mute and UP together for 5 seconds.

**c29= 3** External delayed alarm (delay = P28) with manual reset (circuit 1)  
The alarm condition occurs when the contact remains open for a time greater than P28. Once alarm E03 is activated, if the alarm condition ceases (contact closes), normal control does not resume automatically, and the audible signal, the alarm code E03 and any alarm output remain active. Control can start again only after pressing Prg/mute and UP together for 5 seconds.

**c29= 4** ON/OFF  
The digital input establishes the status of the unit:  
- with the digital input closed, the controller is ON.  
- when the digital input is open the controller is OFF. The consequences of switching OFF are:  
• the display shows the message OFF, alternating with the value of the probe and any alarm codes (E01/E02/E06/E07/E08) active before switching off;  
• the control outputs are deactivated (OFF), while observing any minimum on time (c9)

- the buzzer, if active, is muted;
- the alarm outputs, if active, are deactivated
- any new alarms that arise in this status are not signalled, except for (E01/E02/E06/E07/E08).

**c29=5** Start operating cycle.  
To start the operating cycle from the button, P70 must be =2 and P29 =5 for digital input 1 and P70=3 and c30=5 for digital input 2.

**c29=6** Override outputs, circuit 1.  
The override condition is active when the contact is open. The outputs relating to circuit 1 (see par. "Independent operation") are overridden based on the settings of the "Type of override" parameters (see par. 5.6.11)  
**c29=7** Delayed signal only alarm E17 (P33, measured in seconds). The alarm condition occurs when the contact is open. The signal only alarm E17 shows the spanner icon flashing on the display and has no effect on control. The dependence parameter (c34, c38, c42, c46=29) can be used to select an output that in normal conditions does not perform any control functions, while in the event of alarms switches ON/100%/10Vdc.

**c29=8** Immediate signal only alarm E17.  
Same as c29=7, without a delay.

**For the following settings to take effect, independent operation must be active (c19=7).**

- c29=9** Immediate external alarm, automatic reset (circuit 2). Same as c29=1, for circuit 2.
- c29=10** Immediate external alarm, manual reset (circuit 2). Same as c29=2, for circuit 2.
- c29=11** Delayed external alarm(P33), manual reset (circuit 2). Same as c29=3, for circuit 2.
- c29=12** Override outputs, circuit 2. Same as c29=6, for circuit 2.

Parameter c29 is not operative when c0=6, 7, 8, or in special operation (c33=1) when "dependence"=16 and 17. These operating modes in fact exploit digital input 1 to switch the set point and/or the operating logic, therefore any change to the value of this parameter has no affect.

## 6. CONTROL

### ON/OFF and PID control

The controller can operate with two types of control:

- ON/OFF (proportional), in which the actuator either operates at full power or is off. This is a simple control mode that in certain cases can achieve satisfying results;
- PID, useful for systems in which the response of the controlled value compared to the changeable value does allow to eliminate the error in steady operation and improve the regulation. The changeable value becomes an analogue value that continuously varies between 0 and 100%.

 In PID control, the proportional band coincides with the differential (parameters P1/P2).

### 6.1 Type of control (parameter c32)

Par.	Description	Def	Min	Max	UM
c5	Type control 0=ON/OFF(proportional) 1=Proportional+Integral+Derivative (PID)	0	0	1	-

Tab. 6.a

This parameter is used to set the most suitable type of control for the process in question.

 With PID, effective control means the controlled value coincides with the set point or falls within the dead zone; in these conditions, a series of outputs may be active even if not envisaged in the original control diagram. This is the most evident effect of the integral factor.

 PID control, before being applied, requires proportional control only without swings and with good stability in the differentials: only when there is stable P control can PID guarantee maximum effectiveness;

### 6.2 ti\_PID, td\_PID (parameters c62,c63, d62,d63)

These are the PID parameters to be set for the application

Par.	Description	Def	Min	Max	UoM
c62	ti_PID1	600	0	999	s
c63	td_PID1	0	0	999	s
d62	ti_PID2	600	0	999	s
d63	td_PID2	0	0	999	s

Tab. 6.b

The table below shows the probe used by PID1 and PID2 based on the setting of c19.

c19	PID1 (dependence=1)	PID2 (dependence = 2)
1	B1-B2	B1
7	B1 (circuit 1)	B2 (circuit 2)
8	max(B1, B2)	B1
9	min(B1, B2)	B1
0, 2, 3, 4, 5, 6, 10, 11	B1	B1

Tab. 6.c

 For the explanation of operation of control based on the setting of c19, see par. 6.5.

 To eliminate the effect of the integral and derivative factors, set the respective parameters ti and td=0

 Setting td=0 and ti ≠ 0 achieves P+I operation, widely used for controlling environments in which the temperature does not have considerable variations.

 To eliminate the error in steady operation, PI control can be implemented, as the integral factor reduces the average value of the error. Nonetheless, a high impact of this factor (remember that it contributes in an inversely proportional way to the time 'ti') may increase temperature swings, overshoots and the time taken for the controlled variable to increase and decrease, bringing instability.

 To resolve such overshoots due to the use of the integral time, the derivative factor can be introduced, which acts as a damper to the swings. Nonetheless, needlessly increasing the derivative factor (increasing the time 'td') increases the time taken for the controlled variable to increase and decrease and can also cause system instability. The derivative factor however has no affect whatsoever on the error in steady operation.

### 6.3 Auto-Tuning (parameter c64)

 The Auto-Tuning function is incompatible with independent operation (c19=7).

The controller leaves the factory with default settings of the PID parameters; these allow standard PID control, but are not optimised for the system that IR33 controls. Consequently, the Auto-Tuning procedure can be used to fine-tune the 3 parameters involved, so as to ensure control that is optimised for the system where it is installed: different systems, with different dynamics, will generate parameters that differ greatly.

Auto-Tuning includes two operating procedures:

- **Tuning the controller when commissioning the system.**
- **Fine-tuning the controller with parameters that have already been tuned, during normal operation.**

In both modes, the control first needs to be programmed setting the following parameters:

c0 =1 or 2, that is, "direct" or "reverse" control;

c5 =1, that is, PID control enabled;

c64 =1, that is, Auto-Tuning enabled;

St1= working set point.

#### Tuning the controller when commissioning the system.

This procedure is performed when commissioning the system, and involves an initial tuning of the PID control parameters to analyse the dynamics of the overall installation; the information acquired is indispensable for both this procedure and any further tuning operations performed.

During commissioning, the system is in a stationary state, that is, it is not powered and is in thermal balance at room temperature; this state must be maintained when programming the controller before starting the Auto-Tuning procedure. The controller must be programmed by setting the parameters specified previously, making sure to avoid starting to control the loads and thus altering the state of the system (that is, increasing or decreasing the temperature). This can be achieved by not connecting the control outputs to the loads or keeping the loads off (not powered). Once programmed, **the controller must be switched off**, if necessary the connections of the outputs to the loads must be restored and finally power connected to the entire system: controller and unit. The controller will then start the Auto-Tuning procedure, identified by the TUNING icon flashing on the display, performing a preliminary check on the starting conditions, and assessing their suitability, that is, for a system in "direct" mode the starting temperature measured by the control probe must be:

-higher than the set point;

-more than 5°C from the set point;

for a system in "reverse" mode, the starting temperature measured by the control probe must be:

-lower than the set point;

-more than 5°C from the set point.

If the starting conditions are not suitable, the procedure will be not be started and the controller will show the corresponding alarm "E14"; the controller will remain in this status without perform any operation, awaiting a reset or until switched off and on again. The procedure can be repeated to check whether the starting conditions have changed and Auto-Tuning can start. If on the other hand the starting conditions are suitable, the controller will start a series of operations that modify the

current state of the system, introducing alterations that when measured are used to calculate the most suitable PID parameters for the system in question. In this phase, the temperature reached by the unit may differ considerably from the set point, and may also return to the starting value. At the end of the process (maximum duration of 8 hours), if the outcome is positive, the values calculated for the control parameters will be saved and will replace the default value, otherwise nothing will be saved and the controller will signal an alarm (see the table of alarms), and exit the procedure. In these cases, the signal remains until manually reset or the controller is switched off and on again, while the Auto-Tuning procedure will in any case be terminated and the parameters will not be modified.

**Fine-tuning the controller with parameters that have already been tuned, during normal operation.**

If the controller has already been tuned a first time, the Auto-Tuning procedure can be repeated to further tune the values. This is useful when the loads have changed since the first procedure was performed, or to allow finer tuning. The controller in this case can manage the system using the PID parameters, and further Auto-Tuning will have the effect of improving control.

This time, the procedure can be started during normal control of the system (with c0 = 1 or 2, that is, control in "direct" or "reverse" mode, and c5 = 1, that is, PID control enabled); the controller in this case does not need to be switched off and on again; simply:

- set parameter c64 to 1;
- press the ▲ button for 5 seconds, after which the unit will display the message "tun" and Auto-Tuning will start.

The controller then proceeds with Auto-Tuning as already described above. In both modes described, if the procedure ends positively, the controller will automatically set parameter c64 to zero and will activate PID control with the new parameters saved.

▶ The Auto-Tuning procedure should not be considered essential in achieving optimum control of the system; experienced users can also achieve excellent results by setting the parameters manually.

▶ For users experienced in operating the IR32 Universal family controllers in P+I mode, simply set c5=1 (that is, PID control enabled) and use the default values of the parameters, thus replicating the behaviour of the previous model of controller.

**6.4 Operating cycle**

⚠ The operating cycle function is incompatible with independent operation (c19=7).

The operating cycle is an automatic program that can have a maximum of 5 set points to be reached in the 5 respective time intervals. This may be useful for automating processes in which the temperature must follow a set profile for a certain time (e.g. milk pasteurisation).

⚠ The duration and temperature must be set for all 5 steps.

▶ The operating cycle is started from the keypad, digital input or automatically by RTC. See the chapter on the "User interface".

⚠ If the duration of step x, (P73, P75, P77, P79) is set a zero, it means that the controller only manages the temperature. The controller will try to reach the set temperature in the shortest possible time, after which it will go to the next step. On the contrary, P71 must be set ≠ 0. With duration of the step ≠ 0, the controller will try to reach the set temperature in the established time, and then anyway it will go on to the next step.

▶ If during a operating cycle the unit is switched OFF, control stops however the step continues to be counted. Once the unit is started again (ON), control resumes.

⚠ The operating cycle is stopped automatically in the event of a probe fault or error from digital input.

Par.	Description	Def	Min	Max	UoM
P70	Enable working cycle 0=Disabled 1=Keypad 2=Digital input 3=RTC	0	0	3	-
P71	Working cycle: step 1 duration	0	0	200	min
P72	Working cycle: step 1 temperature set point	0 (32)	-50 (-58)	150 (302)	°C(°F)
P72	Working cycle: step 1 temperature set point	0 (32)	-199 (-199)	800(800)	°C(°F)
P73	Working cycle: step 2 duration	0	0	200	min
P74	Working cycle: step 2 temperature set point	0 (32)	-50 (-58)	150 (302)	°C(°F)
P74	Working cycle: step 2 temperature set point	0 (32)	-199 (-199)	800(800)	°C(°F)
P75	Working cycle: step 3 duration	0	0	200	min
P76	Working cycle: step 3 temperature set point	0 (32)	-50 (-58)	150 (302)	°C(°F)
P76	Working cycle: step 3 temperature set point	0 (32)	-199 (-199)	800(800)	°C(°F)
P77	Working cycle: step 4 duration	0	0	200	min
P78	Working cycle: step 4 temperature set point	0 (32)	-50 (-58)	150 (302)	°C(°F)
P78	Working cycle: step 4 temperature set point	0 (32)	-199 (-199)	800(800)	°C(°F)
P79	Working cycle: step 5 duration	0	0	200	min
P80	Working cycle: step 5 temperature set point	0 (32)	-50 (-58)	150 (302)	°C(°F)
P80	Working cycle: step 5 temperature set point	0 (32)	-199 (-199)	800(800)	°C(°F)

Tab. 6.d

Example 1: Heating cycle with infinite temperature control

In this example, Step1 is used to bring the system to the temperature SetA, while the next step ensures infinite temperature control. In this case only 2 steps would be needed, however the cycle requires the Temperature and Time parameters to be set for all of the steps. For this reason, Steps 2, 3 and 4 are set to the control temperature SetA for a time of 1 (this could in any case be set to the maximum value available, being infinite temperature control), while for the fifth and final step the time is set to "0". This means the operating cycle will not stop unless the operator intervenes.

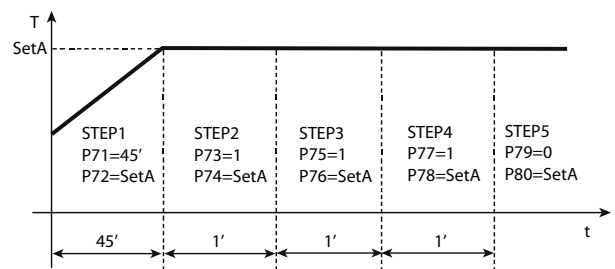

Fig. 6.a

Example 2: Heating cycle with intermediate pauses

At the end of Step5, the operating cycle ends automatically and control resumes based on Set1.

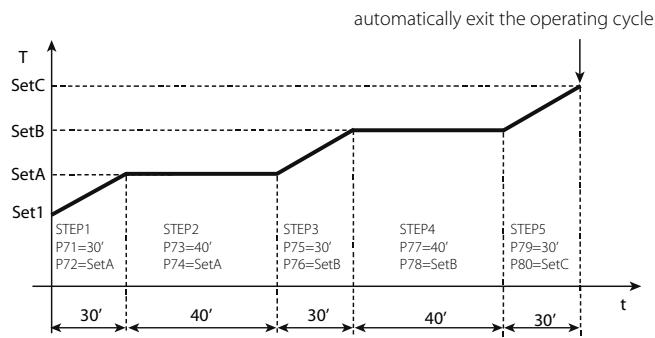

Fig. 6.b

Example 3: Low pasteurisation cycle

At the end of Step5, the operating cycle ends automatically and control resumes based on Set1.

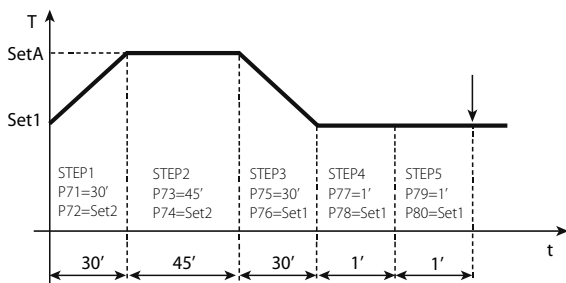

Fig. 6.c

Example 4: High pasteurisation cycle

In this example, having set the time for the last step to "0", the operating cycle does not end until the operator intervenes, and temperature control continues infinitely. As the temperature for infinite temperature control is equal to the temperature set for Set1, the system will behave as if it were in normal control, however the display will show CL5 to indicate that the operating cycle is still in progress.

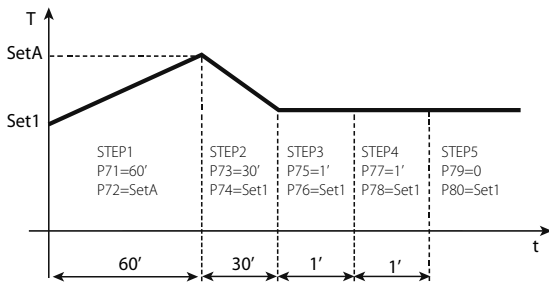

Fig. 6.d

Key  
T= temperature  
t = time

6.5 Operation with probe 2

Installing probe 2 allows various types of operation to be enabled, selected using parameter c19.

6.5.1 Differential operation (parameter c19=1)

The second probe (B2) must be installed. Control is performed by comparing the set point St1 against the difference between the two probes (B1-B2). In practice, the controller acts so that the difference B1-B2 is equal to St1. As mentioned, the management of the second probe is only available in modes c0=1 & 2.

"Direct" operation (c0=1) is suitable for applications in which the controller needs to stop the difference B1-B2 from increasing.

"Reverse" operation (c0=2), on the other hand, stops the difference B1-B2

from decreasing. Below are some examples of applications.

Example 1:

A refrigeration unit with 2 compressors must lower the temperature of the water by 5°C.

Introduction: having selected a controller with 2 outputs to manage the 2 compressors, the first problem to be faced relates to the positioning of probes B1 and B2. Remember that any temperature alarms can only refer to the value read by probe B1. The example indicates the inlet temperature as T1 and the outlet temperature as T2.

Solution 1a: install B1 on the water inlet if it is more important to control the inlet temperature T1; that will allow alarm signals, where necessary delayed, relating to a "High" inlet temperature T1. For example, when B1=T1 the set point corresponds to "B1-B2", i.e. "T1-T2", and must be equal to +5°C (St1=5). The operating mode will be "reverse" (c0=2), given that the controller activates the outputs as the value of "T1-T2" decreases, and tends towards 0. Choosing a differential equal to 2°C (P1=2), a high temperature threshold equal to 40°C (P26=40) and a delay of 30 minutes (P28=30), the operation will be as described in the following figure.

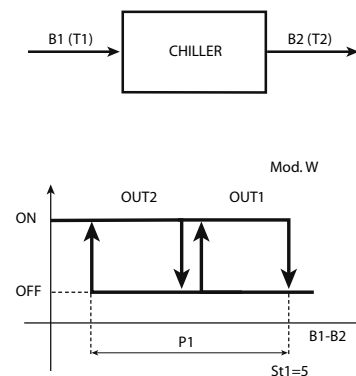

Fig. 6.e

Solution 1b: if on the other hand priority is attributed to T2 (e.g. "Low temperature" threshold 6°C with a one minute delay), the main probe, B1, must be set as the outlet temperature. With these new conditions, the set point St1, equal to "B1-B2", i.e. 'T2-T1', must now be set to -5°C. The operating mode will be "direct" (c0=1), given that the controller must activate the outputs as the value of "T2-T1" increases, and from -5 tends towards 0. P25=6 and P28=1(min) activate the "Low temperature" alarm, as shown in the new control logic diagram:

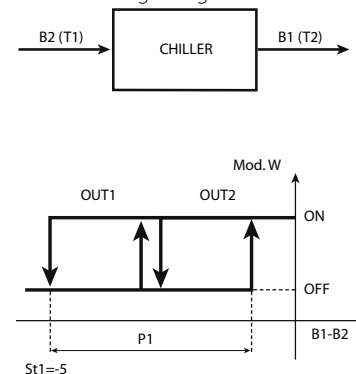

Fig. 6.f

Example 1 (continued)

Example 1 can be resolved using "special" operation (c33=1). Starting from solution 1b (T2 must be 5°C less than T1). The main probe is located at the outlet (T2 =B1).

These requirements also need to be satisfied:

- the outlet temperature T2 must remain above 8°C;
- if T2 remains below 6°C for more than one minute, a "Low temperature" alarm must be signalled.

Solution: use a controller with 4 outputs (IR33Z\*\*\*\*); two outputs are used for control (OUT3 and OUT4), and one for the remote alarm signal (OUT1). OUT2 will be used to deactivate outputs OUT3 and OUT4 when T2 < 8°C. To do this, simply connect OUT2 in series with OUT3 and OUT4, then make OUT2 active only when B1 (T2) is greater than 8°C.

Set c33=1: the changes to be made to the special parameters are:

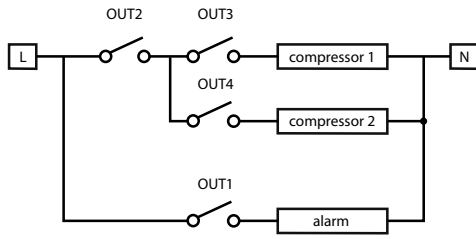

Fig. 6.g

Output 1: must be programmed as an alarm output that is active only for the "Low temperature" alarm. Set "dependence"=c34, which changes from 1 to 9 (or 10 to use normally ON relays). The other parameters for output 1 are not relevant and remain unchanged.

Output 2: this becomes detached from differential operation, changing the "dependence" from 1 to 2: "dependence"=c38=2. The logic is "direct" and includes all of P2, therefore "activation" =c40 becomes 100, and "differential/logic"=c41 becomes -100. St2 will obviously be set to 8 and P2 represents the minimum variation required to restart control, once it has stopped due to "Low temperature", e.g. P2=4.

Output 3 and Output 4: in the controllers with 4 outputs, mode 1 assigns each output an hysteresis of 25% of the differential P1. In the example, considering that 2 outputs are used for control, the hysteresis for each output must be 50% of P1. The "activation" and "differential/logic" parameters for the outputs must be changed to suit the new situation. In practice, this means setting:

Output 3:

"activation"=c44 changes from 75 to 50

"differential/logic"=c45, changes from -25 to -50.

Output 4:

"activation"=c48 remains at 100

"differential/logic"= c49 changes from -25 to -50.

The diagram summarises the controller operating logic.

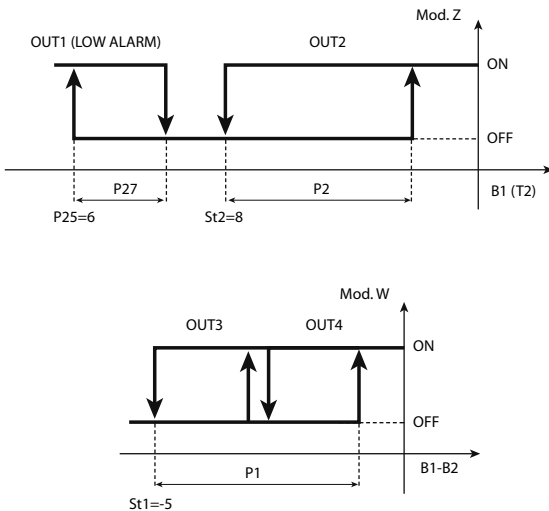

Fig. 6.h

### 6.5.2 Compensation

The compensation function is used to modify the control set point St1 according to the reading of the second probe B2 and the reference set point St2. Compensation has a weight equal to c4, called the "authority".

**!** The compensation function can only be activated when c0=1,2.

**!** When compensation is in progress, parameter St1 remains at the set value; on the other hand, the operating value of St1 changes, known as the effective St1, that is, the value used by the control algorithm. The effective St1 is also restricted by the limits c21 and c22 (minimum and maximum value of St1); these two parameters guarantee that St1 does not reach undesired values.

### 6.5.3 Compensation in cooling (parameter c19=2)

Compensation in cooling may either increase or decrease the value of St1, depending on whether c4 is positive or negative.

St1 only changes if the temperature B2 exceeds St2:

- if B2 is greater than St2 then: effective St1 = St1 + (B2-St2)\*c4
- if B2 is less than St2: effective St1 = St1

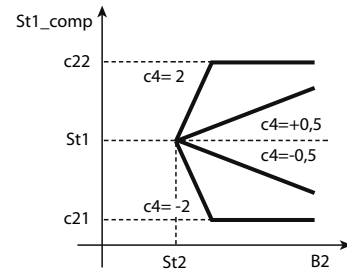

Fig. 6.i

Key:

St2	Activation set point 2
St1_comp	Effective set point 1
B2	Outside probe
c4	Authority
c21	Minimum value of set point 1
c22	Maximum value of set point 1

Example 1:

The bar in a service station needs to be air-conditioned so that the temperature in summer is around 24°C. To prevent the customers, who only stay for a few minutes, from experiencing considerable differences in temperature, the inside temperature is linked to the outside temperature, that is, it increases proportionally up to a maximum value of 27°C, when the outside temperature is 34°C or higher.

Solution: a controller is used to manage a direct expansion air/air unit. The main probe B1 is installed in the bar, the controller works in mode c0=1 (direct) with set point=24°C (St1=24) and differential e.g. 1°C (P1=1). To exploit compensation in cooling mode, install probe B2 outside and set c19=2. Then set St2=24, given that the requirement is to compensate set point 1 only when the outside temperature exceeds 24 °C. The authority c4 must be 0.3, so that with variations in B2 from 24 to 34°C, St1 changes from 24 to 27°C. Finally, select c22=27 to set the maximum value for the effective St1. The graph shows how St1 changes according to the temperature B2.

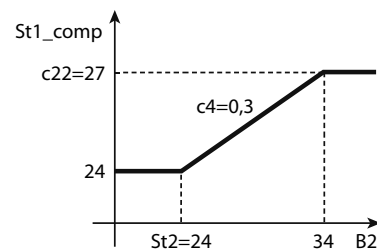

Fig. 6.j

Key:

St2	Activation set point 2
St1_comp	Effective set point 1
B2	Outside probe
c4	Authority
c22	Maximum value of set point 1

Example 2:

This example involves compensation in cooling with a negative c4. The air-conditioning system consists of a water chiller and some fan coil units. When the outside temperature is below 28°C, the chiller inlet temperature can be fixed at St1=13°C. If the outside temperature increases, to compensate for the greater thermal load, the inlet temperature can be lowered down to a minimum limit of 10°C, reached when the temperature is greater than or equal to 34°C.

Solution: the parameters to be set on the controller, with one or more outputs in relation to the characteristics of the chiller, will be as follows:

- c0=1, main probe B1 on the chiller inlet, with a main control set point

St1=13°C and differential P1=2.0°C.  
 For compensation in cooling: c19=2, enabled for outside temperatures, measured by B2, greater than 28°C, therefore St2=28. The authority, considering that St1 must be lowered by 3°C in response to a variation in B2 of 6°C (34-28), will be c4= -0.5. Finally, to prevent the inlet temperature from falling below 10°C, a minimum limit must be set for St1, with c21=10. The graph below shows the trend in St1.

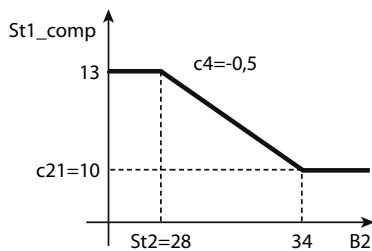

Fig. 6.k

Key:	
St2	Activation set point 2
St1_comp	Effective set point 1
B2	Outside probe
c4	Authority
c21	Minimum value of set point 1

**6.5.4 Compensation in heating (parameter c19=3)**

Compensation in heating can increase or decrease the value of St1 depending on whether c4 is negative or positive respectively. St1 only varied if the temperature B2 is less than St2:

- if B2 is lower than St2 then: effective St1 = St1 + (B2-St2)\*c4
- if B2 is greater than St2: effective St1 = St1

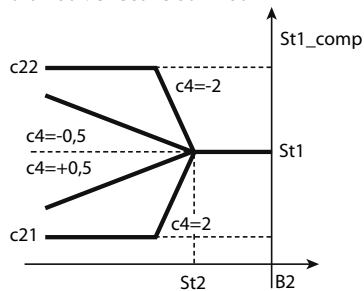

Fig. 6.l

Key:	
St2	Activation set point 2e
St1_comp	Effective set point 1
B2	Outside probe
c4	Authority
c21	Minimum value of set point 1
c22	Maximum value of set point 1

Example 4:

The design specifications are as follows: in order to optimise the efficiency of a boiler in a home heating system, the operating temperature (St1) can be set at 70°C for outside temperatures above 15°C. When the outside temperature drops, the operating temperature of the boiler must increase proportionally, until reaching a maximum temperature of 85°C when the outside temperature is less than or equal to 0°C.

Solution: use a controller with the main probe B1 on the water circuit, mode 2 (heating), set point St1=70 and differential P1=4. In addition, probe B2 must be installed outside and compensation enabled in heating (c19=3) with St2=15, so that the function is only activated when the outside temperature is less than 15°C. To calculate the "authority", consider that in response to a variation in B2 of -15°C (from +15 to 0°C), St1 must change by +15°C (from 70°C to 85°C), so c4= -1.

Finally, set the maximum limit for St1, selecting c22=85°C. The following graph shows how St1 varies as the outside temperature measured by B2 decreases.

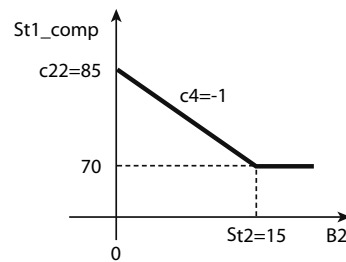

Fig. 6.m

Key:	
St2	Activation set point 2
St1_comp	Effective set point 1
B2	Outside probe
c4	Authority
c22	Maximum value of set point 1

**6.5.5 Continuous compensation (parameter c19=4)**

The compensation of St1 is active for values of B2 other than St2: with this value of c19, parameter P2 can be used to define a dead zone around St2 in which compensation is not active, that is, when the value read by B2 is between St2-P2 and St2+P2, compensation is disabled and St1 is not changed:

- if B2 is greater than (St2+P2), effective St1 = St1 + [B2-(St2+P2)]\*c4
- if B2 is between (St2-P2) and (St2+P2), effective St1 = St1
- if B2 is less than (St2-P2), effective St1 = St1 + [B2-(St2-P2)]\*c4

▶ Compensation using c19=4 is the combined action of compensation in cooling and compensation in heating, as described above. The following diagrams show continuous compensation for positive and negative values of c4. Neglecting the effect of P2, if c4 is positive St1 increases when B2>St2 and decreases when B2<St2. Vice-versa, if c4 is negative St1 decreases when B2 > St2 and increases when B2 is below St2.

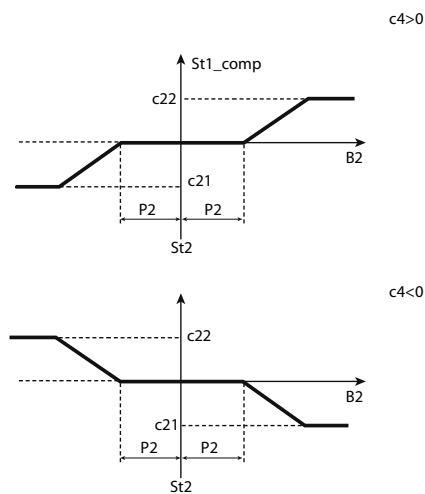

Fig. 6.n

Key:	
St2	Activation set point 2
St1_comp	Effective set point 1
B2	Outside probe
c4	Authority
c22	Maximum value of set point 1
c21	Minimum value of set point 1

**6.5.6 Enable logic on absolute set point & differential set point (parameter c19=5,6)**

When c19=5 the value read by probe B2 is used to enable control logic in both direct and reverse mode.  
If c19=6 the value considered is B2-B1.

Par.	Description	Def	Min	Max	UoM
c19	Operation of probe 2 5=enable logic on set absolute 6=enable logic on set differential Validity: c0=1 or 2	0	0	6	-
c66	Enabling threshold in direct mode Validity: c0=1 or 2	-50 (-58)	-50 (-58)	150 (302)	°C/°F
c67	Enabling threshold in reverse mode Validity: c0=1 or 2	150 (302)	-50 (-58)	150 (302)	°C/°F
c66	Start enabling interval Validity: c0=1 or 2	-50 (-58)	-199 (-199)	800 (800)	°C(°F)
c67	End enabling interval Validity: c0=1 or 2	150 (302)	-199 (-199)	800 (800)	°C(°F)

Tab. 6.g

**“Reverse” control with enable logic**

Looking at the example of a controller with two outputs, one of which ON/OFF and the other 0 to 10 Vdc. When the temperature read by probe B2, if c19=5, or the difference B2-B1, if c19=6, is within the interval (c66, c67), “reverse” control is enabled on St1 and P1; outside of this temperature range control is disabled.

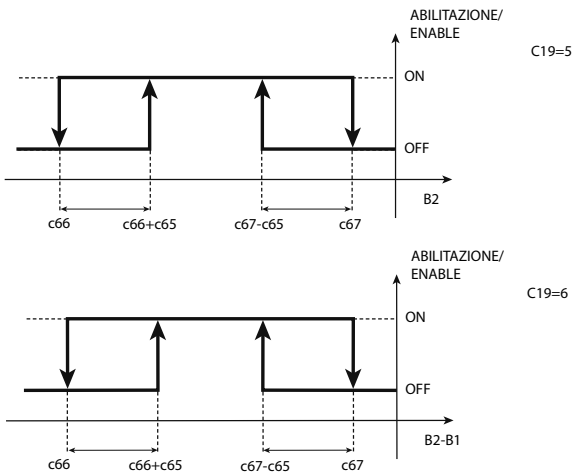
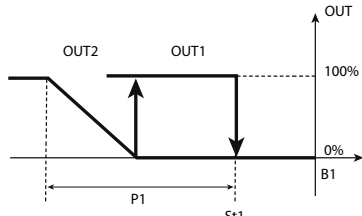

Fig. 6.o

**“Direct” control with enable logic:**

In this case too, a controller with two outputs, one of which a ON/OFF and the other 0 to 10 Vdc. When the temperature read by probe B2, if c19=5, or the difference B2-B1, if c19=6, is within the interval (c66, c67), “direct” control is enabled on St1 and P1; outside of this temperature range control is disabled.

**6.5.7 Independent operation (circuit 1+circuit 2) (parameter c19=7)**

Setting c19=7 control is “split” on two independent circuits, called circuit 1 and circuit 2, each with its own set point (St1, St2), differential (P1, P2) and PID parameters (ti\_PID, td\_PID).

This operation can only be set when c0=1 and 2 and is incompatible with the activation of the operating cycle.

If c33=0, when setting c19=7 the control outputs are assigned to circuit 1 or circuit 2, depending on the model, as shown in the table below.

**OUTPUT ASSIGNMENT**

model	circuit 1 (St1, P1)	circuit 2 (St2, P2)
1 relay	-	-
2 relays	OUT1	OUT2
4 relays	OUT1, OUT2	OUT3, OUT4
4 SSRs	OUT1, OUT2	OUT3, OUT4
1 relay +1 0 to 10 Vdc	OUT1	OUT2
2 relays +2 0 to 10 V dc	OUT1, OUT2	OUT3, OUT4

Tab. 6.h

Note that in general output 1 is always assigned to circuit 1, while output 2 can be assigned to circuit 1 or circuit 2. To assign any other output to circuits 1 or 2, go to special operation (dependence=1 to assign the outputs to circuit 1 and dependence= 2 to assign the outputs to circuit 2).

Example 1: configure outputs 1, 2 to operate with “direct” logic using set point and differential 5, and outputs 3, 4 to operate with “reverse” logic with setpoint -5 and differential 5.

Solution: set c0=1, c19=7, in this way St1 and P1 depend on probe B1 and St2, P2 depend on probe B2. In addition St1=+5, P1=5 and St2=-5, P2=5. Then activate special operation (c33=1) and set the activation and differential/logic for outputs 3 and 4 as follows:

	OUT 3	OUT 4
Activation	c44= -50	c48= -100
Differential/logic	c45= +50	c49= +50

Tab. 6.i

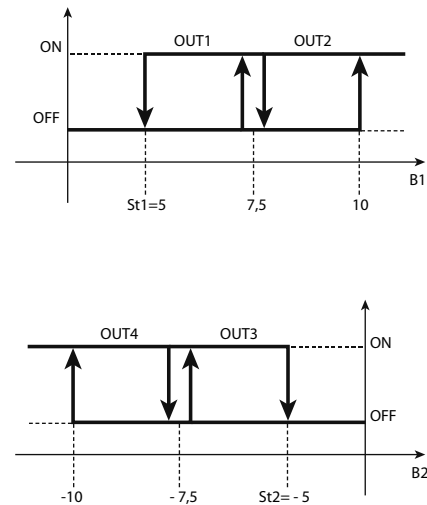

Fig. 6.p

### 6.5.8 Control on higher/lower probe value (parameter c19=8/9)

Setting c19=8, the probe used by the controller to activate control and consequently the outputs is whichever probe measures the higher value.

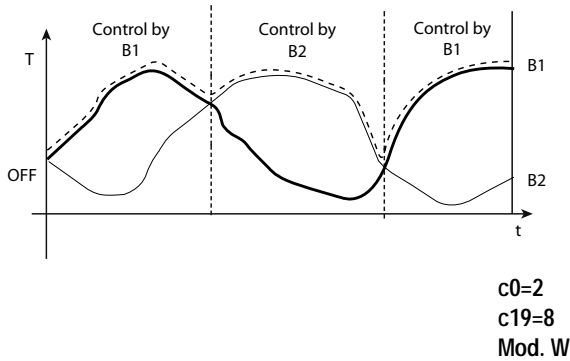

Fig. 6.q

Key:  
T= temperature  
t= time

Setting c19=9, the probe used by the controller to activate control and consequently the outputs is whichever probe measures the lower value.

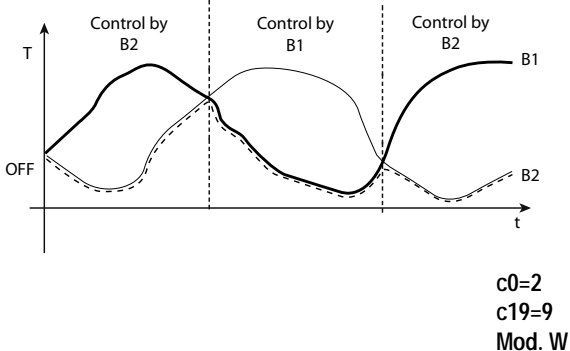

Fig. 6.r

Key:  
T= temperature  
t= time

### 6.5.9 Control set point set from probe 2 (parameter c19=10)

The control set point is no longer fixed, but rather varies based on the value of probe B2. For current or voltage inputs, St1 will not be the voltage or current value, but rather the value shown on the display, depending on parameters d15 and d16.

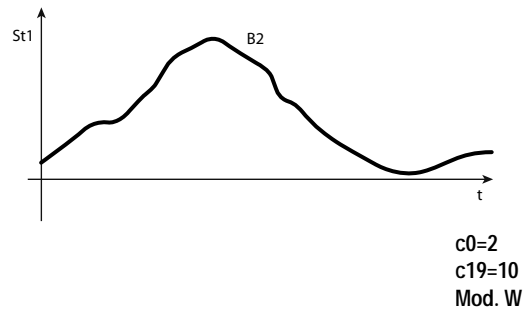

Fig. 6.s

Key:  
T= temperature  
t= time

### 6.5.10 Heat/cool changeover from probe B2 (parameter c19=11)

When c19=11, if the value of probe B2 within the interval defined by c66 and c67, the controller remains in standby. When the value of probe B2 is less than C66, control is performed based on the parameters set by the user; while when the value of probe B2 is higher than c67, the set point, band and control logic are changed automatically.

One typical example is the changeover in operation of the fan coil based on the supply water temperature.

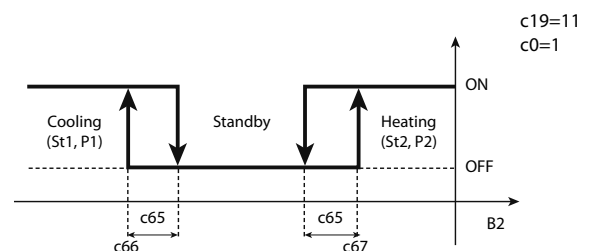

Fig. 6.t

⚠ Do not use this function in combination with dependency settings 16 and 17.

### 6.5.11 Using the CONV0/10A0 module (accessory)

This module converts a 0 to 12 Vdc PWM signal for solid state relays to a linear 0 to 10 Vdc and 4 to 20 mA analogue signal.

Programming: to get the modulating output signal, the PWM control mode is used (see the explanation for parameter c12). The PWM signal is reproduced exactly as an analogue signal: the percentage ON time corresponds to the percentage of the maximum output signal. The optional CONV0/10A0 module integrates the signal provided by the controller: the cycle time (c12) must be reduced to the minimum value available, **that is, c12=0.2 s**. As concerns the control logic ("direct"=cooling, "reverse"=heating), the same observations seen for PWM operation apply (see mode 4): the PWM activation logic is faithfully reproduced as an analogue signal. If, on the other hand, a custom configuration is required, refer to the paragraphs on special operation ("type of output", "activation", "differential/logic" parameters).



## 7. TABLE OF PARAMETERS

➡ In the parameter tables, repeated parameters highlight different settings on the models with universal inputs compared to the models with temperature inputs only.

Par.	Description	Note	Def	Min	Max	UoM	Type	CAREL SPV	ModBus®	R/W	Icon
St1	Set point 1		20 (68)	c21	c22	°C (°F)	A	4	4	R/W	🔍
St2	Set point 2		40 (104)	c23	c24	°C (°F)	A	5	5	R/W	🔍
c0	Operating mode 1= direct 2= reverse 3= dead zone 4= PWM 5= alarm 6= direct/reverse from digital input 1 7= direct: set point and differential from digital input 1 8= reverse: set point and differential from digital input 1 9= direct and reverse with distinct set points.		2	1	9	-	I	12	112	R/W	🔍
P1	Set point 1 differential		2 (3,6)	0.1 (0,2)	50 (90)	°C (°F)	A	6	6	R/W	🔍
P2	Set point 2 differential		2 (3,6)	0.1 (0,2)	50 (90)	°C (°F)	A	7	7	R/W	🔍
P3	Dead zone differential		2 (3,6)	0 (0)	20 (36)	°C (°F)	A	8	8	R/W	🔍
P1	Set point 1 differential		2 (3,6)	0.1 (0,2)	99,9 (179)	°C (°F)	A	6	6	R/W	🔍
P2	Set point 2 differential		2 (3,6)	0.1 (0,2)	99,9 (179)	°C (°F)	A	7	7	R/W	🔍
P3	Dead zone differential		2 (3,6)	0 (0)	99,9 (179)	°C (°F)	A	8	8	R/W	🔍
c4	Authority. Validity: mode 1 or 2		0,5	-2	2	-	A	9	9	R/W	🔍
c5	Type of control 0=ON/OFF (Proportional) 1=Proportional+Integral+Derivative (PID)		0	0	1	-	D	25	25	R/W	🔍
c6	Delay between activation of 2 different relay outputs Validity: c0≠4		5	0	255	s	I	13	113	R/W	🔍
c7	Minimum time between activation of the same relay output Validity: c0 ≠ 4		0	0	15	min	I	14	114	R/W	🔍
d1	Minimum time between deactivation of 2 different relay outputs Validity: c0 ≠ 4		0	0	255	s	I	15	115	R/W	🔍
c8	Minimum relay output off time Validity: c0 ≠ 4		0	0	15	min	I	16	116	R/W	🔍
c9	Minimum relay output on time Validity: c0 ≠ 4		0	0	15	min	I	17	117	R/W	🔍
c10	Status of control outputs on circuit 1 in the event of probe 1 alarm 0=All outputs OFF 1=All outputs ON 2="Direct" outputs on, "reverse" outputs off 3="Direct" outputs off, "reverse" outputs on"		0	0	3	-	I	18	118	R/W	🔍
d10	Status of control outputs on circuit 2 in the event of probe 2 alarm see c10		0	0	3	-	I	112	212	R/W	🔍
c11	Output rotation 0=Rotation not active 1=Standard rotation (on 2 or 4 relays) 2=2+2 rotation 3=2+2 rotation (COPELAND) 4=Rotate outputs 3 and 4, do not rotate 1 and 2 5=Rotate outputs 1 and 2, do not rotate 3 and 4 6=Rotate separately pairs 1,2 (between each other) and 3,4 (between each other) 7=Rotate outputs 2,3,4, do not rotate output 1 8=Rotate outputs 1 and 3, do not rotate 2 and 4 Validity: c0=1,2,7,8 and c33=0		0	0	8	-	I	19	119	R/W	🔍
c12	PWM cycle time		20	0,2	999	s	A	10	10	R/W	🔍
c13	Probe type 0=Standard NTC range (-50T+90°C) 1=NTC-HT enhanced range (-40T+150°C) 2=Standard PTC range (-50T+150°C) 3=Standard PT1000 range (-50T+150°C)		0	0	3	-	I	20	120	R/W	🔍

Par.	Description	Note	Def	Min	Max	UoM	Type	CAREL SPV	ModBus®	R/W	Icon
c13	Probe type 0= Standard NTC range (-50T+110°C) 1= NTC-HT enhanced range (-10T+150°C) 2= Standard PTC range (-50T+150°C) 3= Standard PT1000 range (-50T+200°C) 4= PT1000 enhanced range (-199T+800°C) 5= Pt100 standard range (-50T+200°C) 6= Pt100 enhanced range (-199T+800°C) 7= Standard J thermocouple range (-50T+200°C) 8= Enhanced J thermocouple range (-100T+800°C) 9= Standard K thermocouple range (-50T+200°C) 10= Enhanced K thermocouple range (-100T+800°C) 11= 0 to 1 Vdc input 12= -0.5 to 1.3 Vdc input 13= 0 to 10 Vdc input 14= 0 to 5 Vdc ratiometric 15= 0 to 20 mA input 16= 4 to 20 mA input		0	0	16	-	I	20	120	R/W	
P14	Probe 1 calibration		0 (0)	-20 (-36)	20 (36)	°C (°F)	A	11	11	R/W	
P15	Probe 2 calibration		0 (0)	-20 (-36)	20 (36)	°C (°F)	A	12	12	R/W	
P14	Probe 1 calibration		0 (0)	-99 (-179)	99,9 (179)	°C (°F)	A	11	11	R/W	
P15	Probe 2 calibration		0 (0)	-99 (-179)	99,9 (179)	°C (°F)	A	12	12	R/W	
c15	Minimum value for probe 1 with current/voltage signal		0	-199	c16	-	A	13	13	R/W	
c16	Maximum value for probe 1 with current/voltage signal		100	c15	800	-	A	14	14	R/W	
d15	Minimum value for probe 2 with current/voltage signal		0	-199	d16	-	A	29	29	R/W	
d16	Maximum value for probe 2 with current/voltage signal		100	d15	800	-	A	30	30	R/W	
c17	Probe disturbance filter		4	1	15	-	I	21	121	R/W	
c18	Temperature unit of measure 0=°C, 1=°F		0	0	1	-	D	26	26	R/W	
c19	Function of probe 2 0= not enabled 1= differential operation 2= compensation in cooling 3= compensation in heating 4= compensation always active 5= enable logic on absolute set point 6= enable logic on differential set point 7= independent operation (circuit 1+circuit 2) 8= control on higher probe value 9= control on lower probe value 10= control set point set by B2 11= automatic heating/cooling changeover from B2		0	0	11	-	I	22	122	R/W	
c21	Minimum value of set point 1		-50 (-58)	-50 (-58)	c22	°C (°F)	A	15	15	R/W	
c22	Maximum value of set point 1		60 (140)	c21	150 (302)	°C (°F)	A	16	16	R/W	
c21	Minimum value of set point 1		-50 (-58)	-199 (-199)	c22	°C (°F)	A	15	15	R/W	
c22	Maximum value of set point 1		110 (230)	c21	800 (800)	°C (°F)	A	16	16	R/W	
c23	Minimum value of set point 2		-50 (-58)	-50 (-58)	c24	°C (°F)	A	17	17	R/W	
c24	Maximum value of set point 2		60 (140)	c23	150 (302)	°C (°F)	A	18	18	R/W	
c23	Minimum value of set point 2		-50 (-58)	-199 (-199)	c24	°C (°F)	A	17	17	R/W	
c24	Maximum value of set point 2		110 (230)	c23	800 (800)	°C (°F)	A	18	18	R/W	
P25	Low temperature alarm threshold on probe 1 if P29=0, P25=0: threshold disabled if P29=1, P25=-50: threshold disabled		-50 (-58)	-50 (-58)	P26	°C (°F)	A	19	19	R/W	
P26	High temperature alarm threshold on probe 1 if P29=0, P26=0: threshold disabled if P29=1, P26=150: threshold disabled		150 (302)	P25	150 (302)	°C (°F)	A	20	20	R/W	
P27	Alarm differential on probe 1		2 (3,6)	0 (0)	50 (90)	°C (°F)	A	21	21	R/W	
P25	Low temperature alarm threshold on probe 1 if P29=0, P25=0: threshold disabled if P29=1, P25=-199: threshold disabled		-50 (-58)	-199 (-199)	P26	°C (°F)	A	19	19	R/W	
P26	High temperature alarm threshold on probe 1 if P29=0, P26=0: threshold disabled if P29=1, P26=800: threshold disabled		150 (302)	P25	800 (800)	°C (°F)	A	20	20	R/W	
P27	Alarm differential on probe 1		2 (3,6)	0 (0)	99,9 (179)	°C (°F)	A	21	21	R/W	
P28	Alarm delay time on probe 1(**)		120	0	250	min (s)	I	23	123	R/W	
P29	Type of alarm threshold on probe 1 0=relative; 1=absolute		1	0	1	-	D	27	27	R/W	
P30	Low temperature alarm threshold on probe 2 if P34=0, P30=0: threshold disabled if P34=1, P30=-50: threshold disabled		-50 (-58)	-50 (-58)	P31	°C (°F)	A	31	31	R/W	
P31	High temperature alarm threshold on probe 2 if P34=0, P31=0: threshold disabled if P34=1, P31=150: threshold disabled		150 (302)	P30	150 (302)	°C (°F)	A	32	32	R/W	
P32	Alarm differential on probe 2		2 (3,6)	0 (0)	50 (90)	°C (°F)	A	33	33	R/W	
P30	Low temperature alarm threshold on probe 2 if P34=0, P30=0: threshold disabled if P34=1, P30=-199: threshold disabled		-50 (-58)	-199 (-199)	P31	°C (°F)	A	31	31	R/W	

P31	High temperature alarm threshold on probe 2 if P34=0, P31=0: threshold disabled if P34=1, P31=800: threshold disabled	150 (302)	P30	800 (800)	°C (°F)	A	32	32	R/W	▲
P32	Alarm differential on probe 2	2 (3,6)	0(0)	99,9 (179)	°C (°F)	A	33	33	R/W	▲
P33	Alarm delay time on probe 2(**)	120	0	250	min (s)	I	113	213	R/W	▲
P34	Type of alarm threshold on probe 2 0=relative; 1=absolute	1	0	1	-	D	37	37	R/W	▲
c29	Digital input 1 0= Input not active 1= Immediate external alarm, Automatic reset (circuit 1) 2= Immediate external alarm, Manual reset (circuit 1) 3= Delayed external alarm (P28), Manual reset (circuit 1) 4= ON/OFF control in relation to status of digital input 5= Activation/deactivation working cycle from button 6= Override outputs (circuit 1) 7= Signal only alarm E17, delayed (P33) 8= Signal only alarm E17, immediate 9= Immediate external alarm, Automatic reset (circuit 2) 10= Immediate external alarm, Manual reset (circuit 2) 11= Delayed external alarm (P33), Manual reset (circuit 2) 12= Override outputs (circuit 2) Validity: c0 other than 6,7, and if c33= 1 with "dependence"=16 and 17. In the event of alarms, the status of the relay depends on c31 or d31	0	0	12	-	I	24	124	R/W	▲
c30	Digital input 2 See c29	0	0	12	-	I	25	125	R/W	🔗
c31	Status of control outputs in circuit 1 in the event of an alarm from digital input 0= All outputs OFF 1= All outputs ON 2= "Reverse" outputs OFF, others unchanged 3= "Direct" outputs OFF, others unchanged	0	0	3	-	I	26	126	R/W	🔗
d31	Status of control outputs in circuit 2 in the event of an alarm from digital input See c31	0	0	3	-	I	114	214	R/W	🔗
c32	Serial connection address	1	0	207	-	I	27	127	R/W	🔗
c33	Special operation 0=Disabled 1= Enabled (Before modifying make sure the required start mode has been selected and programmed (c0))	0	0	1	-	D	28	28	R/W	🔗
c34	Output 1 dependence 0= Output not enabled 1= Control output (St1,P1) 2= Control output (St2,P2) 3= Generic alarm, circuit 1 (relay OFF) 4= Generic alarm, circuit 1 (relay ON) 5= Serious alarm, circuit 1 and E04 (relay OFF) 6= Serious alarm, circuit 1 and E04 (relay ON) 7= Serious alarm, circuit 1 and E05 (relay OFF) 8= Serious alarm, circuit 1 and E05 (relay ON) 9= Alarm E05 (relay OFF) 10= Alarm E05 (relay ON) 11= Alarm E04 (relay OFF) 12= Alarm E04 (relay ON) 13= Serious alarm, circuit 1+2 (relay OFF) 14= Serious alarm, circuit 1+2 (relay ON) 15= Timer 16= Control output with change set point and reverse operating logic from digital input 1 17= Control output with change set point and maintain operating logic from digital input 1 18= ON/OFF status signal 19= Generic alarm, circuit 2 (relay OFF) 20= Generic alarm, circuit 2 (relay ON) 21= Serious alarm, circuit 2 and E15 (relay OFF) 22= Serious alarm, circuit 2 and E15 (relay ON) 23= Serious alarm, circuit 2 and E16 (relay OFF) 24= Serious alarm, circuit 2 and E16 (relay ON) 25= Alarm E16 (relay OFF) 26= Alarm E16 (relay ON) 27= Alarm E15 (relay OFF) 28= Alarm E15 (relay ON) 29= Alarm E17 (relay OFF)	1	0	29	-	I	28	128	R/W	1
c35	Type of output 1	0 (■)	0	1	-	D	29	29	R/W	1
c36	Output 1 activation	-25 (■)	-100	100	%	I	29	129	R/W	1
c37	Output 1 differential/logic	25 (■)	-100	100	%	I	30	130	R/W	1
d34	Output 1 activation restriction	0	0	4	-	I	31	131	R/W	1
d35	Output 1 deactivation restriction	0	0	4	-	I	32	132	R/W	1
d36	Minimum value for modulating output 1	0	0	100	%	I	33	133	R/W	1

d37	Maximum value for modulating output 1		100	0	100	%	I	34	134	R/W	1
F34	Output 1 cut-off 0=Cut-off operation 1=Minimum speed operation		0	0	1	-	D	38	38	R/W	1
F35	Output 1 speed up duration 0= speed up disabled		0	0	120	s	I	115	215	R/W	1
F36	Type of override for output 1 0= Disabled 1= OFF/0 Vdc 2= ON/10 Vdc 3= minimum 4= maximum 5= OFF respecting times		0	0	5	-	I	116	216	R/W	1
c38	Output 2 dependence		1	0	29	-	I	35	135	R/W	2
c39	Type of output 2		0 (■)	0	1	-	D	30	30	R/W	2
c40	Output 2 activation		-50 (■)	-100	100	%	I	36	136	R/W	2
c41	Output 2 differential/logic		25 (■)	-100	100	%	I	37	137	R/W	2
d38	Output 2 activation restriction		0	0	4	-	I	38	138	R/W	2
d39	Output 2 deactivation restriction		0	0	4	-	I	39	139	R/W	2
d40	Minimum value for modulating output 2		0	0	100	%	I	40	140	R/W	2
d41	Maximum value for modulating output 2		100	0	100	%	I	41	141	R/W	2
F38	Output 2 cut-off See F34		0	0	1		D	39	39	R/W	2
F39	Output 2 speed up duration 0= speed up disabled		0	0	120	s	I	117	217	R/W	2
F40	Type of override for output 2 See F36		0	0	5	-	I	118	218	R/W	2
c42	Output 3 dependence		1	0	29	-	I	42	142	R/W	3
c43	Type of output 3		0 (■)	0	1	-	D	31	31	R/W	3
c44	Output 3 activation		-75 (■)	-100	100	%	I	43	143	R/W	3
c45	Output 3 differential/logic		25 (■)	-100	100	%	I	44	144	R/W	3
d42	Output 3 activation restriction		0	0	4	-	I	45	145	R/W	3
d43	Output 3 deactivation restriction		0	0	4	-	I	46	146	R/W	3
d44	Minimum value for modulating output 3		0	0	100	%	I	47	147	R/W	3
d45	Maximum value for modulating output 3		100	0	100	%	I	48	148	R/W	3
F42	Output 3 cut-off See F34		0	0	1		D	40	40	R/W	3
F43	Output 3 speed up duration 0= speed up disabled		0	0	120	s	I	119	219	R/W	3
F44	Type of override for output 3 See F36		0	0	5		I	120	220	R/W	3
c46	Output 4 dependence		1	0	29	-	I	49	149	R/W	4
c47	Type of output 4		0 (■)	0	1	-	D	32	32	R/W	4
c48	Output 4 activation		-100 (■)	-100	100	%	I	50	150	R/W	4
c49	Output 4 differential/logic		25 (■)	-100	100	%	I	51	151	R/W	4
d46	Output 4 activation restriction		0	0	4	-	I	52	152	R/W	4
d47	Output 4 deactivation restriction		0	0	4	-	I	53	153	R/W	4
d48	Minimum value for modulating output 4		0	0	100	%	I	54	154	R/W	4
d49	Maximum value for modulating output 4		100	0	100	%	I	55	155	R/W	4
F46	Output 4 cut-off See F34		0	0	1		D	41	41	R/W	4
F47	Output 4 speed up duration 0= speed up disabled		0	0	120	s	I	121	221	R/W	4
F48	Type of override for output 4 See F36		0	0	5		I	122	222	R/W	4
c50	Lock keypad and remote control		1	0	2	-	I	56	156	R/W	☞
c51	Remote control enabling code 0= Programming from remote control without code		1	0	255	-	I	57	157	R/W	☞
c52	Display 0= Probe 1 1= Probe 2 2= Digital input 1 3= Digital input 2 4= Set point 1 5= Set point 2 6= Probe 1 alternating with Probe 2		0	0	6	-	I	58	158	R/W	☞
c53	Buzzer 0= Enabled 1= Disabled		0	0	1	-	D	33	33	R/W	☞
c56	Delay on power-up		0	0	255	s	I	59	159	R/W	☞
c57	Soft start circuit 1		0	0	99	min/°C	I	60	160	R/W	☞
d57	Soft start circuit 2		0	0	99	min/°C	I	123	223	R/W	☞
c62	ti_PID1		600	0	999	s	I	61	161	R/W	TUNING
c63	td_PID1		0	0	999	s	I	62	162	R/W	TUNING
d62	ti_PID2		600	0	999	s	I	124	224	R/W	TUNING
d63	td_PID2		0	0	999	s	I	125	225	R/W	TUNING
c64	Auto-Tuning 0= Disabled 1= Enabled Validity: c19 ≠7		0	0	1	-	D	34	34	R/W	TUNING
c65	Logical enabling hysteresis		1,5 (2,7)	0 (0)	99,9 (179)	°C (°F)	A	34	34	R/W	☞

Par.	Description	Note	Def	Min	Max	UoM	Type	CAREL SPV	ModBus®	R/W	Icon
c66	Start enabling interval Validity: c0 = 1, 2		-50 (-58)	-50 (-58)	150 (302)	°C (°F)	A	22	22	R/W	🔍
c67	End enabling interval Validity: c0 = 1, 2		150 (302)	-50 (-58)	150 (302)	°C (°F)	A	23	23	R/W	🔍
c66	Start enabling interval Validity: c0 = 1, 2		-50 (-58)	-199 (-199)	800 (800)	°C(°F)	A	22	22	R/W	🔍
c67	End enabling interval Validity: c0 = 1, 2		150 (302)	-199 (-199)	800 (800)	°C(°F)	A	23	23	R/W	🔍
P70	Enable working cycle 0=Disabled 1=Keypad 2=Digital input 3=RTC		0	0	3	-	I	70	170	R/W	🕒
P71	Working cycle: step 1 duration		0	0	200	min	I	71	171	R/W	🕒
P72	Working cycle: step 1 temperature set point		0 (32)	-50 (-58)	150 (302)	°C (°F)	A	24	24	R/W	🕒
P72	Working cycle: step 1 temperature set point		0 (32)	-199 (-199)	800 (800)	°C (°F)	A	24	24	R/W	🕒
P73	Working cycle: step 2 duration		0	0	200	min	I	72	172	R/W	🕒
P74	Working cycle: step 2 temperature set point		0 (32)	-50 (-58)	150	°C/°F	A	25	25	R/W	🕒
P74	Working cycle: step 2 temperature set point		0 (32)	-199 (-199)	800 (800)	°C (°F)	A	25	25	R/W	🕒
P75	Working cycle: step 3 duration		0	0	200	min	I	73	173	R/W	🕒
P76	Working cycle: step 3 temperature set point		0 (32)	-50 (-58)	150 (302)	°C (°F)	A	26	26	R/W	🕒
P76	Working cycle: step 3 temperature set point		0 (32)	-199 (-199)	800 (800)	°C (°F)	A	26	26	R/W	🕒
P77	Working cycle: step 4 duration		0	0	200	min	I	74	174	R/W	🕒
P78	Working cycle: step 4 temperature set point		0 (32)	-50 (-58)	150 (302)	°C (°F)	A	27	27	R/W	🕒
P78	Working cycle: step 4 temperature set point		0 (32)	-199 (-199)	800 (800)	°C (°F)	A	27	27	R/W	🕒
P79	Working cycle: step 5 duration		0	0	200	min	I	75	175	R/W	🕒
P80	Working cycle: step 5 temperature set point		0 (32)	-50 (-58)	150 (302)	°C (°F)	A	28	28	R/W	🕒
P80	Working cycle: step 5 temperature set point		0 (32)	-199 (-199)	800 (800)	°C (°F)	A	28	28	R/W	🕒
P0	Firmware revision		20	0	999	-	I	131	231	R	
AL0	Alarm 0 date - time (press Set) (y= year, M= month, d= day, h= hours, n= minutes)		-	-	-	-	-	-	-	R	🕒
y	AL0_y = alarm 0 year		0	0	99	year	I	76	176	R	🕒
M	AL0_M = alarm 0 month		0	1	12	month	I	77	177	R	🕒
d	AL0_d = alarm 0 day		0	1	31	day	I	78	178	R	🕒
h	AL0_h = alarm 0 hours		0	0	23	hour	I	79	179	R	🕒
n	AL0_n = alarm 0 minutes		0	0	59	minute	I	80	180	R	🕒
E	AL0_t = type of alarm 0		0	0	99	-	I	81	181	R	🕒
AL1	Alarm 1 date - time (press Set) (y= year, M= month, d= day, h= hours, n= minutes)		-	-	-	-	-	-	-	R	🕒
y	AL1_y = alarm 1 year		0	0	99	year	I	82	182	R	🕒
M	AL1_M = alarm 1 month		0	1	12	month	I	83	183	R	🕒
d	AL1_d = alarm 1 day		0	1	31	day	I	84	184	R	🕒
h	AL1_h = alarm 1 hours		0	0	23	hour	I	85	185	R	🕒
n	AL1_n = alarm 1 minutes		0	0	59	minute	I	86	186	R	🕒
E	AL1_t = type of alarm 1		0	0	99	-	I	87	187	R	🕒
AL2	Alarm 2 date - time (press Set) (y= year, M= month, d= day, h= hours, n= minutes)		-	-	-	-	-	-	-	R	🕒
y	AL2_y = alarm 2 year		0	0	99	year	I	88	188	R	🕒
M	AL2_M = alarm 2 month		0	1	12	month	I	89	189	R	🕒
d	AL2_d = alarm 2 day		0	1	31	day	I	90	190	R	🕒
h	AL2_h = alarm 2 hours		0	0	23	hour	I	91	191	R	🕒
n	AL2_n = alarm 2 minutes		0	0	59	minute	I	92	192	R	🕒
E	AL2_t = type of alarm 2		0	0	99	-	I	93	193	R	🕒
AL3	Alarm 3 date - time (pressSet) (y= year, M= month, d= day, h= hour, n= minutes)		-	-	-	-	-	-	-	R	🕒
y	AL3_y = alarm 3 year		0	0	99	year	I	94	194	R	🕒
M	AL3_M = alarm 3 month		0	1	12	month	I	95	195	R	🕒
d	AL3_d = alarm 3 day		0	1	31	day	I	96	196	R	🕒
h	AL3_h = alarm 3 hours		0	0	23	hour	I	97	197	R	🕒
n	AL3_n = alarm 3 minutes		0	0	59	minute	I	98	198	R	🕒
E	AL3_t = type of alarm 3		0	0	99	-	I	99	199	R	🕒
AL4	Alarm 4 date - time (press Set) (y= year, M= month, d= day, h= hours, n= minutes)		-	-	-	-	I	-	-	R	🕒
y	AL4_y = alarm 4 year		0	0	99	year	I	100	200	R	🕒
M	AL4_M = alarm 4 month		0	1	12	month	I	101	201	R	🕒
d	AL4_d = alarm 4 day		0	1	31	day	I	102	202	R	🕒
h	AL4_h = alarm 4 hours		0	0	23	hour	I	103	203	R	🕒
n	AL4_n = alarm 4 minutes		0	0	59	minute	I	104	204	R	🕒
E	AL4_t = type of alarm 4		0	0	99	-	I	105	205	R	🕒
ton	Start unit (Press Set) (d= day ,h= hour, n= minutes)		-	-	-	-	-	-	-	R	🕒
d	tON_d = start day		0	0	11	day	I	106	206	R/W	🕒
h	tON_h = start hours		0	0	23	hour	I	107	207	R/W	🕒
n	tON_m = start minutes		0	0	59	minute	I	108	208	R/W	🕒
toF	Stop unit (Press Set) (d= day, h= hour, n= minutes)		-	-	-	-	-	-	-	R	🕒
d	tOFF_d = stop day		0	0	11	day	I	109	209	R/W	🕒
h	tOFF_h = stop hours		0	0	23	hour	I	110	210	R/W	🕒

Par.	Description	Note	Def	Min	Max	UoM	Type	CAREL SPV	ModBus®	R/W	Icon
n	tOFF_n = stop minutes		0	0	59	minute	I	111	211	R/W	⊙
tc	Date – time (Press Set) (y=Year, M=Month, d=day of the month, u=day of the week, h=hours, n=minutes)		-	-	-	-	-	-	-	R	⊙
y	Date: year		0	0	99	year	I	1	101	R/W	⊙
M	Date: month		1	1	12	month	I	2	102	R/W	⊙
d	Date: day		1	1	31	day	I	3	103	R/W	⊙
u	Date: day of the week (Monday,-)		1	1	7	day	I	4	104	R/W	⊙
h	Hours		0	0	23	hour	I	5	105	R/W	⊙
n	Minutes		0	0	59	minutes	I	6	106	R/W	⊙

Tab. 7.a

⚠ The default, minimum and maximum values of the alarm set points refer to temperature values. With universal inputs (voltage, current), these values must be entered manually based on the range of measurement set.  
(\*\*) for alarms from digital input, the second unit of measure is used.

▣ DEFAULT PARAMETER TABLE

Parameter	Model				
	V	W	Z/A	B	E
c35	0	0	0	0	0
c36	-100	-50	-25	-50	-25
C37	+100	+50	+25	+50	+25
c39	-	0	1	1	1
c40	-	-100	-50	-100	-50
c41	-	+50	+25	+50	+25
c43	-	-	0	-	0
c44	-	-	-75	-	-75
c45	-	-	+25	-	+25
c47	-	-	0	-	1
c48	-	-	-100	-	-100
c49	-	-	+25	-	+25

Tab. 7.b

## 7.1 Variables only accessible via serial connection

Description	Def	Min	Max	UOM	Type	CAREL SPV	Modbus®	R/W
Probe 1 reading	0	0	0	°C/°F	A	2	2	R
Probe 2 reading	0	0	0	°C/°F	A	3	3	R
Output 1 percentage	0	0	100	%	I	127	227	R
Output 2 percentage	0	0	100	%	I	128	228	R
Output 3 percentage	0	0	100	%	I	129	229	R
Output 4 percentage	0	0	100	%	I	130	230	R
Password	77	0	200	-	I	11	111	R/W
Output 1 status	0	0	1	-	D	1	1	R
Output 2 status	0	0	1	-	D	2	2	R
Output 3 status	0	0	1	-	D	3	3	R
Output 4 status	0	0	1	-	D	4	4	R
Digital input 1 status	0	0	1	-	D	6	6	R
Digital input 2 status	0	0	1	-	D	7	7	R
Probe 1 fault alarm	0	0	1	-	D	9	9	R
Probe 2 fault alarm	0	0	1	-	D	10	10	R
Immediate external alarm (circuit 1)	0	0	1	-	D	11	11	R
High temperature alarm, probe 1	0	0	1	-	D	12	12	R
Low temperature alarm, probe 1	0	0	1	-	D	13	13	R
Delayed external alarm (circuit 1)	0	0	1	-	D	14	14	R
Immediate external alarm with manual reset (circuit 1)	0	0	1	-	D	15	15	R
RTC fault alarm	0	0	1	-	D	16	16	R
EEPROM unit parameters alarm	0	0	1	-	D	17	17	R
EEPROM operating parameters alarm	0	0	1	-	D	18	18	R
Maximum time in calculation of PID parameters	0	0	1	-	D	19	19	R
PID gain null	0	0	1	-	D	20	20	R
PID gain negative	0	0	1	-	D	21	21	R
Integral & derivative time negative	0	0	1	-	D	22	22	R
Maximum time in calculation of continuous gain	0	0	1	-	D	23	23	R
Starting situation not suitable	0	0	1	-	D	24	24	R
High temperature alarm, probe 2	0	0	1	-	D	49	49	R
Low temperature alarm, probe 2	0	0	1	-	D	50	50	R
Delayed signal only alarm	0	0	1	-	D	51	51	R
Immediate signal only alarm	0	0	1	-	D	52	52	R
Immediate external alarm (circuit 2)	0	0	1	-	D	53	53	R
Delayed external alarm (circuit 2)	0	0	1	-	D	54	54	R
Immediate external alarm with manual reset (circuit 2)	0	0	1	-	D	55	55	R
Probe reading alarm	0	0	1	-	D	56	56	R
Switch controller On/Off	0	0	1	-	D	36	36	R/W
Reset alarm	0	0	1	-	D	57	57	R/W

Tab. 7.c

➡ Type of variable: A= analogue, D= digital, I= integer

SVP= variable address with CAREL protocol on 485 serial card, ModBus®: variable address with ModBus® protocol on 485 serial card.

The selection between CAREL and ModBus® protocol is automatic. For both of them the speed is fixed to 19200 bit/s.

The devices connected to the same network must have the following serial parameter settings: 8 data bits; 1 start bit; 2 stop bits; parity disabled; baud rate 19200. For CAREL and Modbus® the analogue variables are expressed in tenths (e.g.: 20.3 °C= 203)

## 8. ALARMS

### 8.1 Types of alarms

There are two types of alarms available:

- high (temperature) E04 and low (temperature) E05;
- serious alarms, that is, all the others.

The data memory alarms E07/E08 always cause the control to shutdown. "Alarm" mode (c0=5) can use one or more outputs to signal a low or high temperature, probe disconnected or short-circuited alarm: see the chapter on "Functions". The effect of the outputs on the alarms in special operation depends on the "dependence" parameter: see the chapter on "Functions".

The controller also indicates alarms due to faults on the controller itself, on the probes or in the "Auto-Tuning" procedure. An alarm can also be activated via an external contact. The display shows "Exy" alternating with the standard display. At the same time, an icon flashes (spanner, triangle or clock) and the buzzer may be activated (see the table below). If more than one error occurs, these are shown in sequence on the display.

A maximum of 4 alarms are saved, in a FIFO list (AL0,AL1,AL2,AL3). The last alarm saved can be read from parameter AL0 (see the list of parameters).

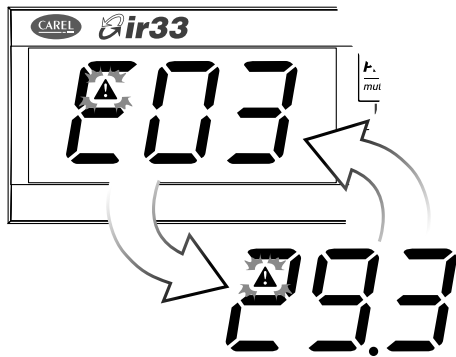

Fig. 8.a

To mute the buzzer press **Prg mute**.

### 8.2 Alarms with manual reset

- To cancel the signal of an alarm with manual reset, once the causes have ceased, press **Prg mute** and ▲ for 5 seconds.

### 8.3 Display alarm queue

- Access the list of Parameters, as described in paragraph 3.3.3.
- Press ▲ / ▼ until reaching parameter "AL0" (last error saved).
- Press **Set**, this accesses a submenu where the ▲ and ▼ buttons can be used to scroll between the year, month, day, hours, minutes and type of alarm activated. If the controller is not fitted with the RTC, only the type is saved.
- From any of the parameters, pressing **Set** returns to the parent parameter "ALx".

Example:

'y07' -> 'M06' -> 'd13' -> 'h17' -> 'm29' -> 'E03'

indicates that alarm 'E03'(alarm from digital input) occurred on 13 June 2007 at 17:29.

### 8.4 Alarm parameters

! The following parameters determine the behaviour of the outputs when an alarm is active.

#### 8.4.1 Status of the control outputs with probe alarm (parameter c10)

This determines the action on the control outputs when there is a control probe alarm E01, which may be one of the four responses envisaged. When OFF is selected, the controller shuts down immediately and the timers are ignored. When ON is selected, on the other hand, the "Delay between activations of two different relay outputs" (parameter c6) is observed. When alarm E01 is resolved, the controller restarts normally and the alarm output, if set, terminates the signal (see mode 5). On the other hand, both the signal on display and the buzzer remain active until **Prg mute** is pressed.

Par	Description	Def	Min	Max	UoM
c10	Status of circuit 1 control outputs with probe 1 alarm 0=All outputs OFF 1= All outputs ON 2="Direct" outputs on, "reverse" off 3="Reverse" outputs on, "direct" off	0	0	3	-
d10	Status of circuit 2 control outputs with probe 2 alarm see c10	0	0	3	-

Tab. 8.a

#### 8.4.2 Alarm parameters and activation

P25 (P26) is used to determine the activation threshold for the low (high) temperature alarm E05 (E04). The value set for P25 (P26) is continuously compared against the value measured by probe B1. Parameter P28 represents the "alarm activation delay", in minutes; the low temperature alarm (E05) is activated only if the temperature remains below the value of P25 for a time greater than P28. The alarm may relative or absolute, depending on the value of parameter P29. In the former case (P29=0), the value of P25 indicates the deviation from the set point and thus the activation point for the low temperature alarm is: set point - P25. If the set point changes, the activation point also changes automatically. In the latter case (P29=1), the value of P25 indicates the low temperature alarm threshold. The low temperature alarm active is signalled by the buzzer and code E05 on the display. The same applies to the high temperature alarm (E04), with P26 instead of P25.

Similar observations apply to the parameters corresponding to probe 2, with the following relationships:

P25\*P30; P26\*P31; P27\*P32; P28\*P33; P29\*P34; E04/E05\*E15/E16.

Par	Description	Def	Min	Max	UoM
P25	Low temperature alarm threshold on probe 1 if P29=0, P25=0: threshold disabled if P29=1, P25=-50: threshold disabled	-50 (-58)	-50(-58)	P26	°C(°F)
P26	High temperature alarm threshold on probe 1 if P29=0, P26=0: threshold disabled if P29=1, P26=150: threshold disabled	150 (302)	P25 (302)	150 (302)	°C(°F)
P27	Alarm differential on probe 1	2 (3,6)	0 (0)	50 (90)	°C(°F)
P25	Low temperature alarm threshold on probe 1 if P29=1, P25=0: threshold disabled if P29=1, P25=-199: threshold disabled	-50 (-58)	-199 (-199)	P26	°C(°F)
P26	High temperature alarm threshold on probe 1 if P29=0, P26=0: threshold disabled if P29=1, P26=800: threshold disabled	150 (302)	P25 (800)	800 (800)	°C(°F)
P27	Alarm differential on probe 1	2(3,6)	0(0)	99,9 (179)	°C(°F)
P28	Alarm delay time on probe 1(**)	120	0	250	min(s)
P29	Type of alarm threshold on probe 1 0=relative; 1=absolute	1	0	1	-

P30	Low temperature alarm threshold on probe 2 if P34=0, P30=0: threshold disabled if P34=1, P30=-50: threshold disabled	-50 (-58)	-50 (-58)	P31	°C(°F)
P31	High temperature alarm threshold on probe 2 if P34=0, P31=0: threshold disabled if P34=1, P31=150: threshold disabled	150 (302)	P30	150 (302)	°C(°F)
P32	Alarm differential on probe 2	2(3,6)	0	50 (90)	°C(°F)
P30	Low temperature alarm threshold on probe 2 if P34=0, P30=0: threshold disabled if P34=1, P30=-199: threshold disabled	-50 (-58)	-199 (-199)	P31	°C(°F)
P31	High temperature alarm threshold on probe 2 if P34=0, P31=0: threshold disabled if P34=1, P31=800: threshold disabled	150 (302)	P30	800 (800)	°C(°F)
P32	Alarm differential on probe 2	2(3,6)	0(0)	99,9 (179)	°C(°F)
P33	Alarm delay time on probe 2(**)	120	0	250	min(s)
P34	Type of alarm threshold on probe 2 0=relative; 1=absolute	1	0	1	-

Tab. 8.b

⚠ P28 sets the minimum time required to generate a high/low temperature alarm (E04/E05) or delayed alarm from external contact (E03).

In the first case (E04/E05) the unit of measure is minutes, in the second case (E03) it is seconds.

Alarms E04 and E05 have automatic reset. P27 represents the hysteresis between the alarm activation value and deactivation value.

If Prg/mute is pressed when the value measured is above one of the thresholds, the buzzer is immediately muted, while the alarm code and the alarm output, if set, remain active until the value measured is outside of the activation threshold.

P28 sets the minimum time required to generate a high/low temperature alarm (E04/E05) or delayed alarm from external contact (E03).

To generate an alarm, the value measured by probe B1 must remain below the value of P25 or above the value of P26 for a time greater than P28. For an alarm from digital input (c29, c30=3), the contact must remain open for a time greater than P28. In the case of an alarm event, a counter starts and generates an alarm when reaching the minimum time P28. If during the count the value measured returns within the threshold or the contact closes, the alarm is not signalled and the count is reset. When a new alarm condition occurs, the count starts from 0 again.

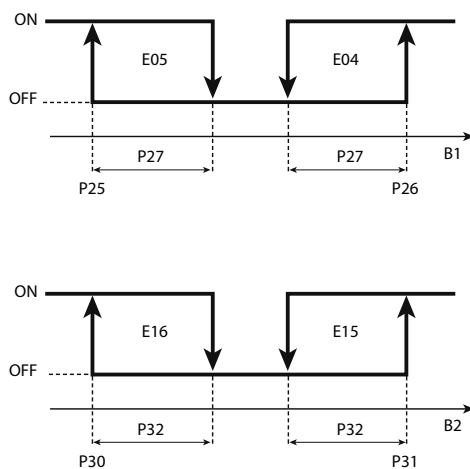

Fig. 8.b

Key	
E04/E15	High alarm, probe B1/B2
E05/E16	Low alarm, probe B1/B2
B1/B2	Probe 1/2

### 8.4.3 Status of the control outputs with alarm from digital input (parameter c31)

Parameter c31 determines the action on the control outputs if an alarm from digital input E03 is active (see c29 and c30). When OFF is selected, the controller shuts down immediately and the timers are ignored. When ON is selected, on the other hand, the "Delay between activations of two different relay outputs" (parameter c6) is observed. If the alarm from digital input has automatic reset (c29=1 and/or c30=1), when normal conditions return (external contact closed), the alarm output, if set (see c0=5) is reset and normal control resumes.

- c31=0 all control outputs OFF
- c31=1 all control outputs ON
- c31=2 only the outputs with "reverse" operation OFF, the others are not affected
- c31=3 only the outputs with "direct" operation OFF, the others are not affected.

Par.	Description	Def	Min	Max	UoM
c31	Status of control outputs in circuit 1 in the event of an alarm from digital input 0= All outputs OFF 1= All outputs ON 2= "Reverse" outputs OFF, others unchanged 3= "Direct" outputs OFF, others unchanged	0	0	3	-
d31	Status of control outputs in circuit 2 in the event of an alarm from digital input See c31	0	0	3	-

Tab. 8.c



## 8.5 Table of alarms

Message on display	Cause of the alarm	Icon on display	Buzzer	Reset	Control action	Checks/solutions
E01 (***)	Probe B1 fault		OFF	automatic	Depends on parameter c10	Check probe connections
E02 (***)	Probe B2 fault		OFF	automatic	If c19=1 & c0=1/2, as for E01, otherwise control does not stop.	Check probe connections
E03 (***)	Digital contact open (immediate alarm)		ON	automatic	Based on parameter c31	Check parameters c29,c30,c31. Check the external contact.
E04 (***)	The temperature measured by the probe has exceeded the threshold P26 for a time greater than P28.		ON	automatic	No effect on control	Check parameters P26,P27, P28,P29
E05 (***)	The temperature measured by the probe has fallen below threshold P25 for a time greater than P28.		ON	automatic	No effect on control	Check parameters P25,P27, P28,P29
E06	Real time clock fault		OFF	automatic /manual	-	Reset the clock time. If the alarm persists, contact service.
E07	EEPROM error, unit parameters		OFF	automatic	Total shutdown	Contact service
E08	EEPROM error, operating parameters		OFF	automatic	Total shutdown	Reset default values using the procedure described. If the alarm persists, contact service.
E09	Acquisition error. Reached max. time in calculation of PID parameters.		ON	manual	Auto-Tuning stopped	Reset the alarm manually or switch the controller off and on again
E10	Calculation error: PID gain null.		ON	manual	Auto-Tuning stopped	
E11	Calculation error: PID gain negative		ON	manual	Auto-Tuning stopped	
E12	Calculation error: Integral & deriv. time negative		ON	manual	Auto-Tuning stopped	
E13	Acquisition error. Reached max. continuous time in calculation of gain.		ON	manual	Auto-Tuning stopped	
E14	Error when starting. Situation not suitable		ON	manual	Auto-Tuning stopped	
E15 (***)	The reading of B2 has exceeded the threshold value P31 for a time greater than P33.		ON	automatic	No effect on control	Check parameters P30,P31,P32,P33
E16 (***)	The reading of B2 has fallen below the threshold value P30 for a time greater than P33.		ON	automatic	No effect on control	Check parameters P30,P31,P32,P33
E17 (***)	Digital contact open (immediate or delayed alarm, signal only)		OFF	automatic	No effect on control	Check parameters c29,c30. Check the external contact
E18 (***)	Digital contact open, immediate alarm, delayed with manual/automatic reset on circuit 2		ON	automatic /manual	Effect on control only if c19=7, based on parameter d31 (*)	Check parameters c29,c30,d31. Check the contact external.
E19 (***)	Probe reading error (**)		OFF	automatico	Total shutdown	Contact service

Tab. 8.d

(\*) exit the working cycle

(\*\*) for IR33 Universal with universal inputs only.

(\*\*\*) error code shown in the alarm queue

- The alarm relay is activated or not based on the operating mode and/or the DEPENDENCE setting  
The alarms that occur during the Auto-Tuning procedure are not put in the alarm queue.

### 8.6 Relationship between dependence parameter and alarm causes

In special operation, the dependence parameter is used to bind the status of a relay output to an alarm condition, as shown in the table below.

**CONDITION FOR ACTIVATING AN OUTPUT CONFIGURED AS AN ALARM**

		Alarm from digital input on circuit 1			Alarm from digital input on circuit 2			Probe fault		Alarm thresholds for B1		Alarm thresholds for B2		Signal only alarm E17	
		IMMEDIATE EXTERNAL,AUTOMATIC RESET	IMMEDIATE EXTERNAL,MANUAL RESET	DELAYED EXTERNAL (P28) MANUAL RESET	IMMEDIATE EXTERNAL,AUTOMATIC RESET	IMMEDIATE EXTERNAL,MANUAL RESET	DELAYED EXTERNAL (P33),MANUAL RESET	PROBE 1	PROBE 2	LOW	HIGH	LOW	HIGH	IMMEDIATE	DELAYED
DEPENDENCE (par. c34, c38, c42, c46)		c29=1 c30=1	c29=2 c30=2	c29=3 c30=3	c29=9 c30=9	c29=10 c30=10	c29=11 c30=11								
Value	Description														
3, 4	generic alarm circuit 1(relay OFF)	X	X	X				X	X	X	X				
	generic alarm circuit 1 (relay ON)														
19, 20	generic alarm circuit 2 (relay OFF)				X	X	X	X	X			X	X		
	generic alarm circuit 2(relay ON)														
5, 6	serious alarm circuit 1 and E04 (relay OFF)	X	X	X				X	X		X				
	serious alarm circuit 1 and E04 (relay ON)														
21, 22	serious alarm circuit 2 and E15 (relay OFF)				X	X	X	X	X				X		
	serious alarm circuit 2 and E15 (relay ON)														
7, 8	serious alarm circuit 1 and E05 (relay OFF)	X	X	X				X	X	X					
	serious alarm circuit 1 and E05 (relay ON)														
23, 24	serious alarm circuit 2 and E16 (relay OFF)				X	X	X	X	X			X			
	serious alarm circuit 2 and E16 (relay ON)														
9, 10	alarm E05 (relay OFF)									X					
	alarm E05 (relay ON)														
25, 26	alarm E16 (relay OFF)											X			
	alarm E16 (relay ON)														
11, 12	alarm E04 (relay OFF)										X				
	alarm E04 (relay ON)														
27, 28	alarm E15 (relay OFF)												X		
	alarm E15 (relay ON)														
13, 14	serious alarm circuits 1 & 2 (relay OFF)	X	X	X	X	X	X	X	X						
	serious alarm circuits 1 & 2 (relay ON)														
29	alarm E17 (relay OFF)													X	X

Tab. 8.e

## 9. TECHNICAL SPECIFICATIONS AND PRODUCT CODES

### 9.1 Technical specifications

	Model	Voltage	Power			
Power supply	IR33x(V,W,Z,A,B,E)7Hx(B,R)20 DN33x(V,W,Z, A,B,E)7Hx(B,R)20	115 to 230 Vac(-15%...+10%), 50/60 Hz	6 VA, 50 mA~ max			
	IR33x(V,W,Z,A,B,E)7LR20, DN33x(V,W,Z,A,B,E)7LR20	12 to 24 Vac (-10%...+10%), 50/60 Hz 12 to 30 Vdc	4 VA, 300 mA~ max 300 mA - max			
Power supply	IR33x(V,W,Z,A,B,E)9Hx(B,R)20 DN33x(V,W,Z, A,B,E)9Hx(B,R)20 IR33x(V,W,Z,A,B,E)9MR20, DN33x(V,W,Z,A,B,E)9MR20	115 to 230 Vac(-15%...+10%), 50/60 Hz	9 VA, 90 mA~ max			
		24 Vac (-10%...+10%), 50/60 Hz 24 Vdc (-10%...+10%)	12 VA, 450 mA~ max 450 mA - max			
		Only use SELV power supply				
Insulation guaranteed by the power supply	IR33x(V,W,Z,A,B,E)x(7, 9)Hx(B,R)20 DN33x(V,W,Z,A,B,E)x(7, 9)Hx(B,R)20	insulation from very low voltage parts	reinforced 6 mm in air, 8 mm on surface 3750 V insulation			
		insulation from relay outputs	main 3 mm in air, 4 mm on surface 1250 V insulation			
	IR33x(V,W,Z,A,B,E)x(7, 9)x(L, M)R20 DN33x(V,W,Z,A,B,E) x(7, 9)x(L, M)R20	insulation from very low voltage parts	to be guaranteed externally by safety transformer			
		insulation from relay outputs	reinforced 6 mm in air, 8 mm on surface 3750V insulation			
Inputs	B1 (PROBE1),B2 (PROBE2)	NTC, NTC-HT, PTC, PT1000 NTC, NTC-HT, PTC, PT1000, PT100, TcJ, TcK, 0-5 V rat, 0-1 Vdc, 0-10 Vdc, -0.5-1,3 Vdc, 0-20 mA, 4-20 mA				
	DI1, DI2	voltage-free contact, contact resistance < 10 Ω, closing current 6 mA Maximum distance of probes and digital inputs less than 10 m Note: in the installation, keep the power and load connections separate from the probe, digital inputs, repeater display and supervisor cables.				
Type of probe	NTC std. CAREL	10 kΩ at 25 °C, range -50T90 °C	measurement error: 1 °C in the range -50T50 °C 3 °C in the range +50T90 °C			
		NTC-HT	50 kΩ at 25°C, range -40T150 °C measurement error: 1,5 °C in the range -20T115 °C 4 °C in range outside of -20T115 °C			
	PTC	985 Ω at 25 °C, range -50T150 °C measurement error 2 °C in the range -50T50 °C 4 °C in the range +50T150 °C				
	PT1000	1097 Ω at 25 °C, range -50T150 °C measurement error: 3 °C in the range -50T0 °C 5 °C in the range 0T150 °C				
Type of probe	NTC std. CAREL	10 kΩ at 25 °C, range -50T110 °C	measurement error: 1 °C in the range -50T110 °C			
		NTC-HT	50 kΩ at 25°C, range -10T150 °C measurement error: 1 °C in the range -10T150 °C			
	PTC	985 Ω at 25 °C, range -50T150 °C measurement error 1 °C in the range -50T150 °C				
	PT1000	1097 Ω at 25 °C measurement error: 1 °C in the range -50T200 °C 2 °C in the range -199T800 °C				
	PT100	109,7 Ω at 25 °C measurement error: 1 °C in the range -50T200 °C 2 °C in the range -199T800 °C				
	TcJ	isolated 52 μV/ °C measurement error: 2 °C in the range -50T200 °C 4 °C in the range -100T800 °C				
	TcK	isolated 41 μV/ °C measurement error: 2 °C in the range -50T200 °C 4 °C in the range -100T800 °C				
	0-5 V rat	Impedance measurement of 50 kΩ	0.3 % Full scale			
	0-1 Vdc	Impedance measurement of 50 kΩ	0.3 % Full scale			
	0-10 Vdc	Impedance measurement of 50 kΩ	0.3 % Full scale			
	-0.5-1,3 Vdc	Impedance measurement of 50 kΩ	0.3 % Full scale			
	0-20 mA	Impedance measurement of 50 Ω	0.3 % Full scale			
	4-20 mA	Impedance measurement of 50 Ω	0.3 % Full scale			
Probe power supply	12 Vdc (rated), maximum current supplied 60 mA ; 5 Vdc (rated), maximum current supplied 20 mA					
Relay outputs		EN60730-1		UL 873		
	models	relay	250 V~	oper. cycles	250 V~	oper. cycles
	IR33x(V,W,Z,B,E)x(7, 9)x(L, M)R20 DN33x(V,W,Z,B,E)x(7, 9)x(L, M)R20 IR33x(V,W,Z,B,E)x(7, 9)Hx(R,B)20 DN33x(V,W,Z,B,E)x(7, 9)Hx(R,B)20	D01, D02 D03, D04 (**)	8(4) A su N.O. 6(4) A su N.C. 2(2) A su N.O. e N.C.	100000	8A res 2FLA 12LRA C300	30000

SSR outputs	model		Max output voltage: 12 Vdc		
	IR33Ax(7, 9)x(L, M)R20 - DN33Ax(7, 9)x(L, M)R20	A = 4 SSR outputs	Output resistance: 600 Ω		
	IR33Ax(7, 9)Hx(R,B)20 - DN33Ax(7, 9)Hx(R,B)20		Output current max: 20 mA		
	maximum length of cables less than 10 m				
0 to 10 Vdc outputs	IR33Bx(7, 9)x(L, M)R20	B = 1 Relay + 1 0 to 10 Vdc	Typical ramp time (10 to 90%): 1 s		
	DN33Bx(7, 9)x(L, M)R20		Max output ripple: 100 mV		
	IR33Ex(7, 9)Hx(R,B)20	E = 2 Relays + 2 0 to 10Vdc	Max output current: 5 mA		
	DN33Ex(7, 9)Hx(R,B)20				
	maximum length of cables less than 10 m				
Insulation guaranteed by the outputs	insulation from extra low voltage parts/insulation between relay outputs D01, D03 and 0 to 10 Vdc outputs (relay outputs A02, A04)		reinforced 6 mm clearance, 8 mm creepage 3750 V insulation		
	insulation between outputs		basic 3 mm clearance, 4 mm creepage 1250 V insulation		
IR receiver	On all models				
Clock with backup battery	IR33x(V,W,Z,A,B,E)x(7, 9)HB20, DN33x(V,W,Z,A,B,E)x(7, 9)HB20				
Buzzer	available on all models				
Clock	error at 25°C	± 10 ppm (±5.3 min/year)			
	Error in range -10T60°C	-50 ppm(±27 min/year)			
	Ageing	< ±5 ppm (±2.7 min/year)			
	Discharge time	6 months typical (8 months maximum)			
	Recharge time	5 hours typical (< 8 hours maximum)			
Operating temperature	-10T60 °C				
Operating humidity	<90% U.R. non-condensing				
Storage temperature	-20T70 °C				
Storage humidity	<90% U.R. non-condensing				
Front panel index of protection	IR33: assembly on smooth and indeformable panel with IP65 gasket DN33: front panel IP40, complete controller IP10				
Construction of control device	Integrated electronic control device				
Environmental pollution	2 normal				
PTI of the insulating materials	Printed circuits 250, plastic and insulating materials 175				
Period of stress across the insulating parts	Long				
Class of protection against voltage surges	Category 2				
Type of action and disconnection	1C relay contacts (microswitching)				
Classification according to protection against electric shock	Class 2 when appropriately integrated				
Device designed to be hand-held or integrated in hand-held devices	No				
Software class and structure	Class A				
Front panel cleaning	Only use neutral detergents and water				
Carel serial network interface	External, available on all models				
Programming key	Available on all models				
Connections	model				
	temperature inputs only	Plug-in, for 0.5 to 2.5 mm <sup>2</sup> cables, max current 12 A			
	universal inputs	Plug-in, power supply and outputs for 0.5 to 2.5 mm <sup>2</sup> cables, max current 12 A Digital and analogue inputs for 0.2 to 1.5 mm <sup>2</sup> cables, max current 8 A			
	Correct sizing of the power and connection cables between the controller and the loads is the responsibility of the installer. In the max load and max operating temp. conditions, the cables used must be suitable for operation up to 105°C.				
Case	plastic	IR33 (panel)	frontal dimensions	76,2x34,2 mm	
			mounting depth	75 mm	
					93 mm
		DN33 (DIN rail)	dimensions	70x110x60	
Assembly	IR33: on smooth and indeformable panel	IR33: side fastening brackets, to be pressed in fully			
	DN33: DIN rail drilling template	IR33: 71x29 mm DN33: 4 DIN modules			
Display	digits	3 digit LED			
	display	-199 to 999			
	operating status	indicated with graphic icons on the display			
Keypad	4 silicone rubber buttons				

Tab. 9.a

In the table of technical specifications, the highlighted values represent the difference between the models with universal inputs and the models with temperature inputs only.

\*\*\*) Relay not suitable for fluorescent loads (neon lights, etc.) that use starters (ballasts) with phase shifting capacitors. Fluorescent lamps with electronic controllers or without phase shifting capacitors can be used, depending on the operating limits specified for each type of relay.

## 9.2 Cleaning the controller

When cleaning the controller do not use ethanol, hydrocarbons (petrol), ammonia and by-products. Use neutral detergents and water.

### 9.3 Product codes

#### IR33-DN33 UNIVERSAL

Flush mount		DIN rail mounting		Description
In. temp.	In. universal	In. temp.	In. universal	
IR33V7HR20	IR33V9HR20	DN33V7HR20	DN33V9HR20	2AI, 2DI, 1DO, BUZ, IR, 115 to 230 V
IR33V7HB20	IR33V9HB20	DN33V7HB20	DN33V9HB20	2AI, 2DI, 1DO, BUZ, IR, RTC, 115 to 230 V
IR33V7LR20	IR33V9MR20 ●	DN33V7LR20	DN33V9MR20 ●	2AI, 2DI, 1DO, BUZ, IR, 12 to 24Vac, 12 to 30Vdc (● = 24 Vac/Vdc)
IR33W7HR20	IR33W9HR20	DN33W7HR20	DN33W9HR20	2AI, 2DI, 2DO, BUZ, IR, 115 to 230V
IR33W7HB20	IR33W9HB20	DN33W7HB20	DN33W9HB20	2AI, 2DI, 2DO, BUZ, IR, RTC, 115 to 230V
IR33W7LR20	IR33W9MR20 ●	DN33W7LR20	DN33W9MR20 ●	2AI, 2DI, 2DO, BUZ, IR, 12-24 Vac, 12 to 30 Vdc (● = 24 Vac/Vdc)
IR33Z7HR20	IR33Z9HR20	DN33Z7HR20	DN33Z9HR20	2AI, 2DI, 4DO, BUZ, IR, 115 to 230 V
IR33Z7HB20	IR33Z9HB20	DN33Z7HB20	DN33Z9HB20	2AI, 2DI, 4DO, BUZ, IR, RTC, 115 to 230 V
IR33Z7LR20	IR33Z9MR20 ●	DN33Z7LR20	DN33Z9MR20 ●	2AI, 2DI, 4DO, BUZ, IR, 12 to 24Vac, 12 to 30Vdc (● = 24 Vac/Vdc)
IR33A7HR20	IR33A9HR20	DN33A7HR20	DN33A9HR20	2AI, 2DI, 4SSR, BUZ, IR, 115 to 230 V
IR33A7HB20	IR33A9HB20	DN33A7HB20	DN33A9HB20	2AI, 2DI, 4SSR, BUZ, IR, RTC, 115 to 230 V
IR33A7LR20	IR33A9MR20 ●	DN33A7LR20	DN33A9MR20 ●	2AI, 2DI, 4SSR, BUZ, IR, 12 to 24Vac, 12 to 30Vdc (● = 24Vac/Vdc)
IR33B7HR20	IR33B9HR20	DN33B7HR20	DN33B9HR20	2AI, 2DI, 1DO+1AO, BUZ, IR, 115 to 230 V
IR33B7HB20	IR33B9HB20	DN33B7HB20	DN33B9HB20	2AI, 2DI, 1DO+1AO, BUZ, IR, RTC, 115 to 230 V
IR33B7LR20	IR33B9MR20 ●	DN33B7LR20	DN33B9MR20 ●	2AI, 2DI, 1DO+1AO, BUZ, IR, 12 to 24 Vac, 12 to 30 Vdc (● = 24 Vac/Vdc)
IR33E7HR20	IR33E9HR20	DN33E7HR20	DN33E9HR20	2AI, 2DI, 2DO+2AO, BUZ, IR, 115 to 230 V
IR33E7HB20	IR33E9HB20	DN33E7HB20	DN33E9HB20	2AI, 2DI, 2DO+2AO, BUZ, IR, RTC, 115 to 230 V
IR33E7LR20	IR33E9MR20 ●	DN33E7LR20	DN33E9MR20 ●	2AI, 2DI, 2DO+2AO, BUZ, IR, 12 to 24 Vac, 12 to 30Vdc (● = 24 Vac/Vdc)
				Programming key
IROPZKEY00				Programming key with power supply
IROPZKEYA0				RS485 serial interface
IROPZ48500				RS485 serial interface with automatic recognition of TxRx+ & TxRx-
IROPZ485S0				RS485 serial card for DN33
				Analogue output module
CONV0/10A0				ON/OFF output module
CONV0NOFF0				

Tab. 9.b

AAI=analogue input; AO=analogue output; DI= digital input; DO=digital output, relay; BUZ=buzzer; IR=infrared receiver; RTC=Real Time Clock.

### 9.4 Conversion tables from IR32 universale

#### 9.4.1 Panel mounting

Models	Temperature inputs		Universal inputs		Description
	ir33	ir32	ir33	ir32	
1 Relay	IR33V7HR20	IR32V0H000	IR33V9HR20	IR32V*H000	2AI, 2DI, 1DO, BUZ, IR, 115 to 230 Vac
	IR33V7HB20		IR33V9HB20		2AI, 2DI, 1DO, BUZ, IR, RTC, 115 to 230 Vac
	IR33V7LR20	IR32V0L000	IR33V9MR20 ●	IR32V*L000	2AI, 2DI, 1DO, BUZ, IR, 12 to 24 Vac 12 to 30 Vdc (● = 24 Vac/dc)
2 Relays	IR33W7HR20		IR33W9HR20		2AI, 2DI, 2DO, BUZ, IR, 115 to 230 Vac
	IR33W7HB20		IR33W9HB20		2AI, 2DI, 2DO, BUZ, IR, RTC, 115 to 230 Vac
4 Relays	IR33W7LR20	IR32W00000	IR33W9MR20 ●	IR32W*0000	2AI, 2DI, 2DO, BUZ, IR, 12 to 24Vac 12 to 30Vdc (● = 24 Vac/dc)
	IR33Z7HR20		IR33Z9HR20		2AI, 2DI, 4DO, BUZ, IR, 115 to 230 Vac
	IR33Z7HB20		IR33Z9HB20		2AI, 2DI, 4DO, BUZ, IR, RTC, 115 to 230 Vac
4 SSR	IR33Z7LR20	IR32Z00000	IR33Z9MR20 ●	IR32Z*0000	2AI, 2DI, 4DO, BUZ, IR, 12 to 24 Vac 12 to 30 Vdc (● = 24 Vac/dc)
	IR33A7HR20		IR33A9HR20		2AI, 2DI, 4SSR, BUZ, IR, 115 to 230 Vac
	IR33A7HB20		IR33A9HB20		2AI, 2DI, 4SSR, BUZ, IR, RTC, 115 to 230 Vac
	IR33A7LR20	IR32A00000	IR33A9MR20 ●	IR32A*0000	2AI, 2DI, 4SSR, BUZ, IR, 12 to 24Vac 12 to 30 Vdc (● = 24 Vac/dc)
1 Relay + 1 0-10 V	IR33B7HR20		IR33B9HR20		2AI, 2DI, 1DO+1AO, BUZ, IR, 115 to 230 Vac
	IR33B7HB20		IR33B9HB20		2AI, 2DI, 1DO+1AO, BUZ, IR, RTC, 115 to 230 Vac
	IR33B7LR20	IR32D0L000 + 1 CONV0/10A0	IR33B9MR20 ●	IR32D*L000 + 1 CONV0/10A0	2AI, 2DI, 1DO+1AO, BUZ, IR, 12 to 24 Vac 12 to 30Vdc (● = 24 Vac/dc)

Tab. 9.c

#### 9.4.2 DIN rail mounting

Models	Temperature inputs		Universal inputs		Description
	ir33	ir32	ir33	ir32	
1 Relay	DN33V7HR20	IRDRV00000	DN33V9HR20	IRDRV*0000	2AI, 2DI, 1DO, BUZ, IR, 115 to 230 Vac
	DN33V7HB20		DN33V9HB20		2AI, 2DI, 1DO, BUZ, IR, RTC, 115 to 230 Vac
	DN33V7LR20		DN33V9MR20 ●		2AI, 2DI, 1DO, BUZ, IR, 12 to 24Vac 12 to 30 Vdc (● = 24 Vac/dc)
2 Relays	DN33W7HR20	IRDRW00000	DN33W9HR20	IRDRW*0000	2AI, 2DI, 2DO, BUZ, IR, 115 to 230 Vac
	DN33W7HB20		DN33W9HB20		2AI, 2DI, 2DO, BUZ, IR, RTC, 115 to 230 Vac
4 Relays	DN33W7LR20		DN33W9MR20 ●		2AI, 2DI, 2DO, BUZ, IR, 12 to 24Vac 12 to 30Vdc (● = 24Vac/dc)
	DN33Z7HR20		DN33Z9HR20		2AI, 2DI, 4DO, BUZ, IR, 115 to 230 Vac
	DN33Z7HB20		DN33Z9HB20		2AI, 2DI, 4DO, BUZ, IR, RTC, 115 to 230 Vac
4 SSR	DN33Z7LR20	IRDRZ00000	DN33Z9MR20 ●	IRDRZ*0000	2AI, 2DI, 4DO, BUZ, IR, 12 to 24 Vac 12 to 30 Vdc (● = 24 Vac/dc)
	DN33A7HR20		DN33A9HR20		2AI, 2DI, 4SSR, BUZ, IR, 115 to 230 Vac
	DN33A7HB20		DN33A9HB20		2AI, 2DI, 4SSR, BUZ, IR, RTC, 115 to 230 Vac
	DN33A7LR20	IRDRA00000	DN33A9MR20 ●	IRDRA*0000	2AI, 2DI, 4SSR, BUZ, IR, 12 to 24 Vac 12 to 30 Vdc (● = 24 Vac/dc)
1 Relay + 1 0-10 V	DN33B7HR20		DN33B9HR20		2AI, 2DI, 1DO+1AO, BUZ, IR, 115 to 230 Vac
	DN33B7HB20		DN33B9HB20		2AI, 2DI, 1DO+1AO, BUZ, IR, RTC, 115 to 230 Vac
	DN33B7LR20	IRDRA00000 + 1 CONV0/10A0	DN33B9MR20 ●	IRDRA*0000 + 1 CONV0/10A0	2AI, 2DI, 1DO+1AO, BUZ, IR, 12 to 24 Vac 12 to 30 Vdc (● = 24 Vac/dc)

Tab. 9.d

(\*) = 0, 1, 2, 3, 4 indicating the types of input in the ir32 range.

## 9.5 Software revisions

REVISION	Description	
1.0	Functions active starting from software version higher than 1.0	
	FUNCTION	Parameter
	Soft start	c57
	Logical enabling	c19=5,6 / c66, c67
1.1	0 to 10 V outputs	d36, d40, d44, d48
		d37, d41, d45, d49
	Improved operation of the remote control.	
	Fixes:	
	- compensation	
	- logical enabling	
	- NTC HT probe reading	
	- operating cycle activation by RTC	
	- transmission of parameter c12	
	- LED out on display in event of rotation	
	New functions:	
	FUNCTION	PARAMETER
	Soft start	c57
	Logical enabling	c19=5,6 / c66, c67
	0 to 10 V outputs	d36, d40, d44, d48
		d37, d41, d45, d49
	Cut off	c68
1.2	Varied temperature range and IP for DIN rail versions. Standardised behaviour and display of the 0 to 10 Vdc outputs and the PWM outputs.	
	Fixes:	
		- operation with probe 2 in special mode
		- rotation for units with 2 relays (model W)
	- display the new value read by the probe during calibration (parameters P14, P15)	
	- direct access to the setting of set point 2 when c19= 2, 3 and 4	
	- changes made to the parameters in the "clock" area in the event of direct access from the remote control	
1.4	Fixes:	
		- operation in differential mode (c19=1) when the unit works in °F (c18=1)
	- management from the supervisor and from user interface of parameter c4 when working in °F (c18=1)	
2.0	Addition of Multi-Input models (FW 2.0) and extra functions in temperature only models (FW 2.0). New parameters and functions:	
		- c15, c16: select range of measurement for probe B1 with voltage and current signal
		- d15, d16 select range of measurement for probe B2 with voltage and current signal
		- independent operation (circuit 1+circuit 2, c19=7)
		- control on higher probe value (c19=8)
		- control on lower probe value (c19=9)
		- control set point selected by probe B2 (c19=10)
		- auto heat/cool switching from probe B2 (c19=11)
		- speed up (F35, F39, F43, F47)
		- cut off (F34, F38, F42, F46)
		- type of override (F36, F38, F42, F46)
		- additional functions of digital inputs (c29, c30=6-12)
		- new rotation (c11=8)
		- new display show (c52 =4, 5, 6)
		- signal controller ON/OFF status (c34/c38/c42/c46=18)
		- hysteresis for enable logic (c65)
	- introduction of high temperature, low temperature threshold, differential, delay time, type of alarm threshold for probe 2 (parameters P30, P31, P32, P33, P34)	

Tab. 9.e



# CAREL

**CAREL INDUSTRIES HQs**

Via dell'Industria, 11 - 35020 Brugine - Padova (Italy)

Tel. (+39) 0499 716611 - Fax (+39) 0499 716600

carel@carel.com - www.carel.com

*Agenzia / Agency:*