

INTIMIDATOR™ SPOT DUO

User Manual

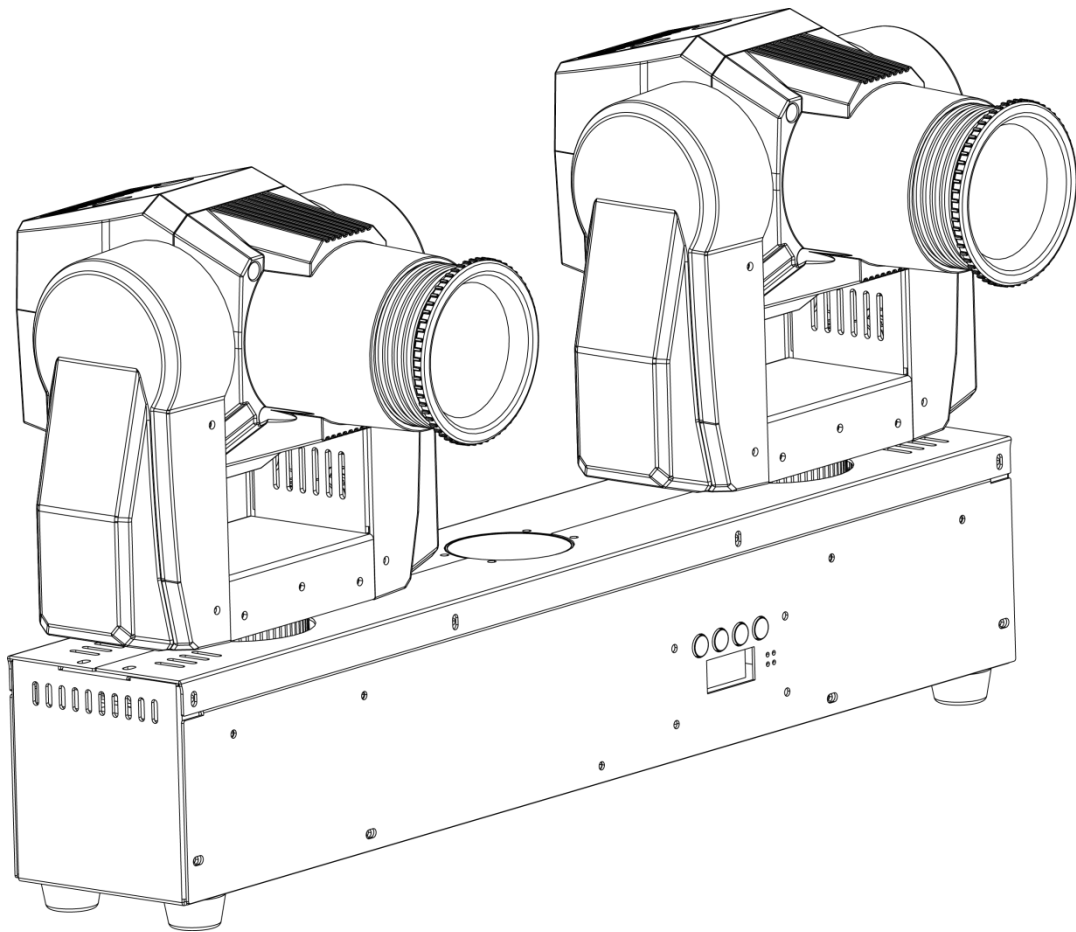

CHAUVET®
It's
Green Thinking.™

TABLE OF CONTENTS

1. Before You Begin	4
What Is Included.....	4
Unpacking Instructions	4
Claims	4
Text Conventions	4
Symbols.....	4
Disclaimer.....	4
Product at a Glance.....	5
Safety Notes.....	5
2. Introduction	6
Overview.....	6
Dimensions.....	7
3. Setup	8
AC Power	8
Fuse Replacement	8
Power Linking.....	9
Mounting.....	10
Orientation.....	10
Rigging	10
4. Operation	11
Control Panel Operation.....	11
Menu Map.....	11
Configuration (DMX).....	12
Starting Address.....	12
DMX Personalities.....	12
DMX Channel Modes, Assignments, and Values	13
20-Channel.....	13
20-Channel (cont.).....	14
20-Channel (cont.).....	15
20-Channel (cont.).....	16
17-Channel.....	17
17-Channel (cont.).....	18
17-Channel (cont.).....	19
Configuration (Standalone)	23
Sound-Active Mode	23
Sound Sensitivity	23
Automatic Mode.....	23
Pan Operation	24
Tilt Operation.....	24
Pan/Tilt Angle Range.....	24
Display.....	24
Temperature Display	24
Reset Software	24
Load Factory Defaults	24
Master Auto Programs.....	25
Master Auto	25
4-Head Program.....	25
Master Auto	25
2-Head Program.....	25
5. Technical Information	26
Product Maintenance	26

6. Technical Specifications.....27
Returns**Error! Bookmark not defined.**
Contact Us.....**Error! Bookmark not defined.**

1. BEFORE YOU BEGIN

What Is Included

- Intimidator™ Spot Duo
- Hanging Bracket with Mounting Hardware
- Power Cord
- Warranty Card
- Quick Reference Guide

Unpacking Instructions

Carefully unpack the product immediately and check the container to make sure all the parts are in the package and are in good condition.

Claims



If the box or the contents (the product and included accessories) appear damaged from shipping, or show signs of mishandling, notify the carrier immediately, not Chauvet. Failure to report damage to the carrier immediately may invalidate your claim. In addition, keep the box and contents for inspection.

For other issues, such as missing components or parts, damage not related to shipping, or concealed damage, file a claim with Chauvet within 7 days of delivery.

Text Conventions

Convention	Meaning
1—512	A range of values
50/60	A set of values of which only one can be chosen
Settings	A menu option not to be modified
Menu > Settings	A sequence of menu options to be followed
<ENTER>	A key to be pressed on the product's control panel
ON	A value to be entered or selected

Symbols

Symbol	Meaning
	Critical installation, configuration, or operation information. Not following these instructions may make the product not work, cause damage to the product, or cause harm to the operator.
	Important installation or configuration information. The product may not function correctly if this information is not used.
	Useful information.

Disclaimer

The information and specifications contained in this User Manual are subject to change without notice. Chauvet assumes no responsibility or liability for any errors or omissions, and reserves the right to revise or recreate this manual at any time. Download the latest version from www.chauvetlighting.com.

© Copyright 2015 Chauvet. All rights reserved.

Electronically published by Chauvet in the United States of America.

Author	Date	Editor	Date
R. Isenstadt	02/23/15	A. Leon	02/25/15

Product at a Glance

Use on Dimmer	X	Auto Programs	P
Outdoor Use	X	Auto-ranging Power Supply	P
Sound-Activated	P	Replaceable Fuse	P
DMX	P	User-Serviceable	X
Master/Slave	P		

Safety Notes

These notes include important information about the mounting, usage, and maintenance of this product; read before using the product.



- Always connect the product to a grounded circuit to avoid the risk of electrocution.
- Always disconnect the product from the power source before cleaning or replacing the fuse.
- Avoid direct eye exposure to the light source while the product is on.
- Make sure the power cord is not crimped or damaged.
- Never disconnect the product from power by pulling or tugging on the cord.
- If mounting the product overhead, always secure to a fastening device using a safety cable.
- Make sure there are no flammable materials close to the product when operating.
- Do not touch the product's housing when operating because it may be very hot.



- Always make sure that the voltage of the outlet to which you are connecting the product is within the range stated on the decal or rear panel of the product.
- The product is for indoor use only! (IP20) To prevent risk of fire or shock, do not expose the product to rain or moisture.
- Always install the product in a location with adequate ventilation, at least 20 in (50 cm) from adjacent surfaces.
- Be sure that no ventilation slots on the product's housing are blocked.
- Never connect the product to a dimmer.
- Make sure to replace the fuse with another of the same type and rating.
- Never carry the product from the power cord or any moving part. Always use the hanging/mounting bracket.
- The maximum ambient temperature (Ta) is 104 °F (40 °C). Do not operate the product at higher temperatures.
- In the event of a serious operating problem, stop using the product immediately.
- Never try to repair the product. Repairs carried out by unskilled people can lead to damage or malfunction. Contact the nearest authorized technical assistance center.
- This product is not intended for permanent installation.
- To eliminate wear and improve its lifespan, during periods of non-use completely disconnect from power via breaker or by unplugging it.



Keep this User Manual for future use. If you sell the product to another user, be sure to give this document to the next owner.

2. INTRODUCTION

Overview

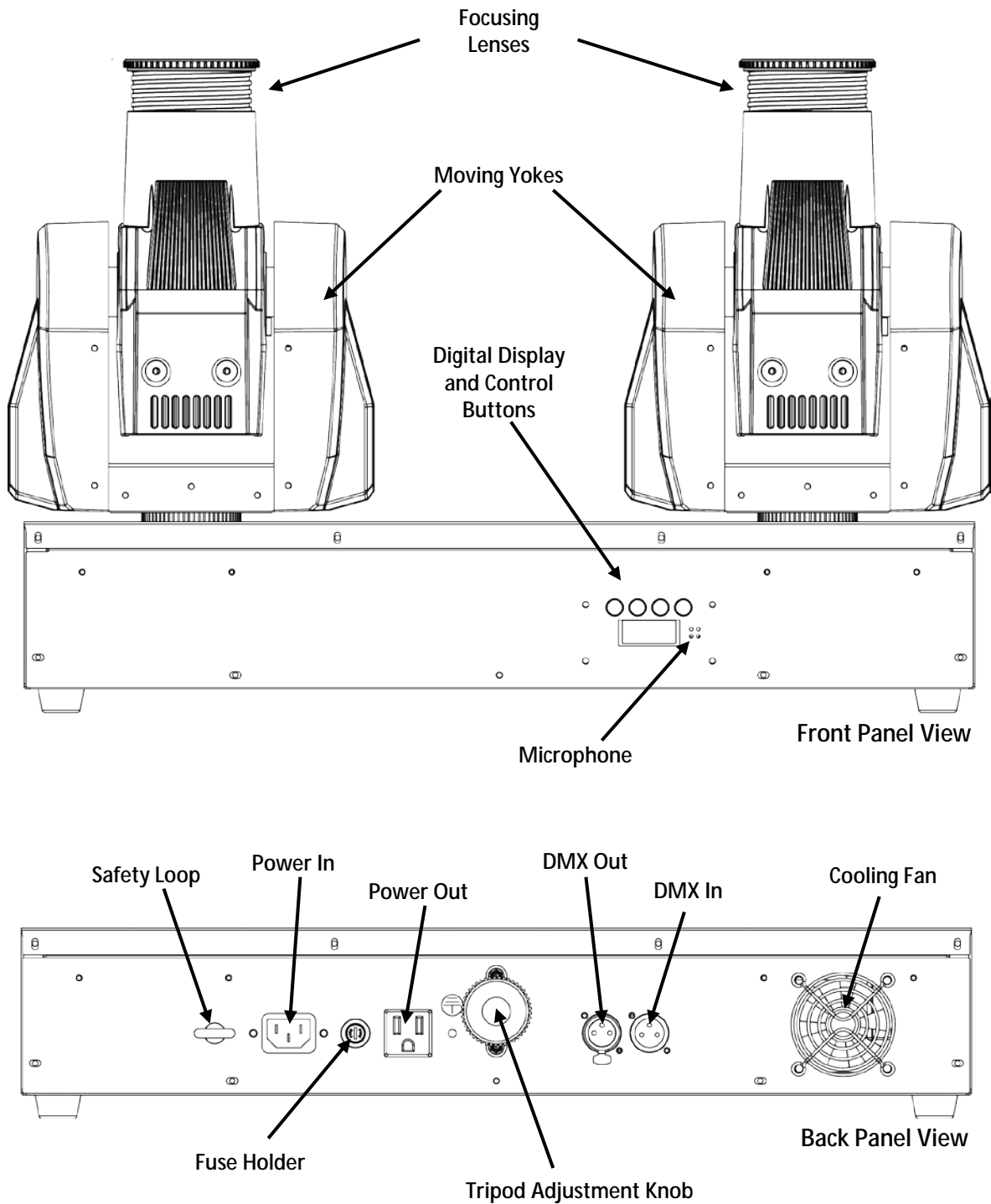

Dimensions

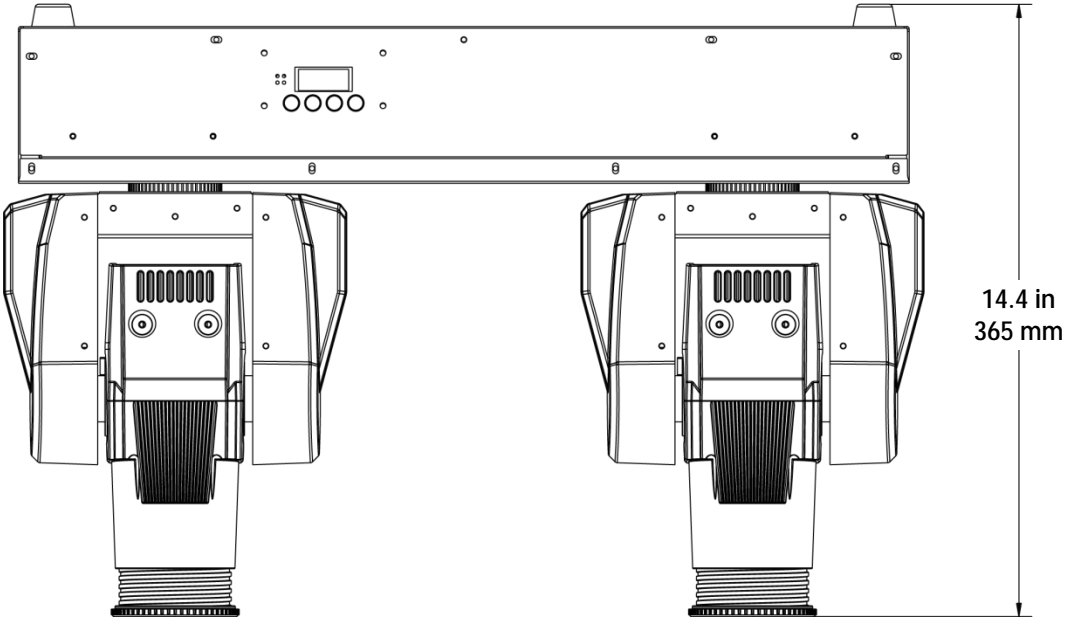
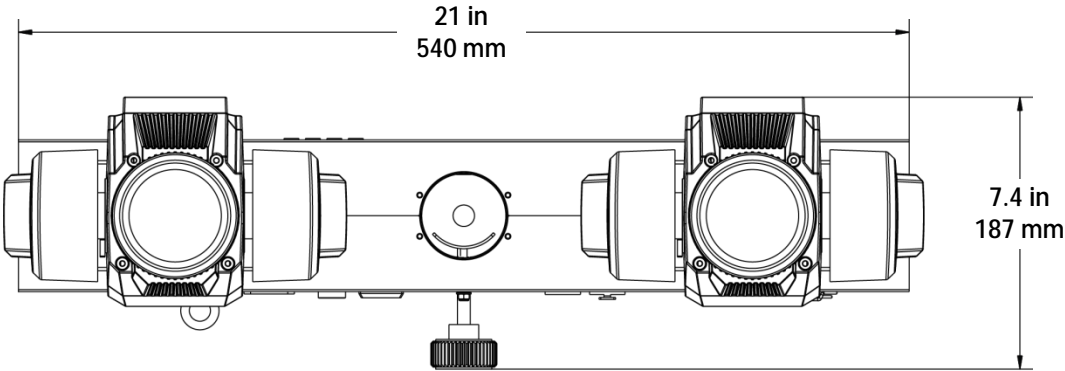

3. SETUP

AC Power The Intimidator™ Spot Duo has an auto-ranging power supply and it can work with an input voltage range of 100 to 240 VAC, 50/60 Hz.

To determine the product's power requirements (circuit breaker, power outlet, and wiring), use the current value listed on the label affixed to the product's back panel, or refer to the product's specifications chart. The listed current rating indicates the product's average current draw under normal conditions.



- **Always connect the product to a protected circuit (circuit breaker or fuse). Make sure the product has an appropriate electrical ground to avoid the risk of electrocution or fire.**
- **To eliminate wear and improve its lifespan, during periods of non-use completely disconnect from power via breaker or by unplugging it.**



Never connect the product to a rheostat (variable resistor) or dimmer circuit, even if the rheostat or dimmer channel serves only as a 0 to 100% switch.

Fuse Replacement



Disconnect the product from power before replacing the fuse.

1. Disconnect the product from power.
2. With a flat-head screwdriver, unscrew the fuse holder cap from the housing.
3. Remove the blown fuse.
4. Replace with a fuse of the same type and rating.
5. Screw the fuse holder cap back in place and reconnect power.

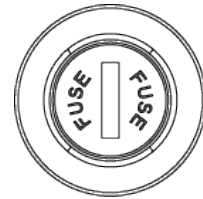

Always replace a blown fuse with another of the same type and rating.

Power Linking The product provides power linking via the Edison/IEC outlet located in the back of the unit.

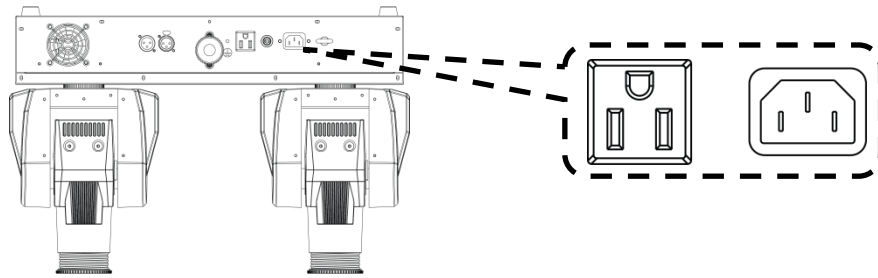

Power Linking Diagram

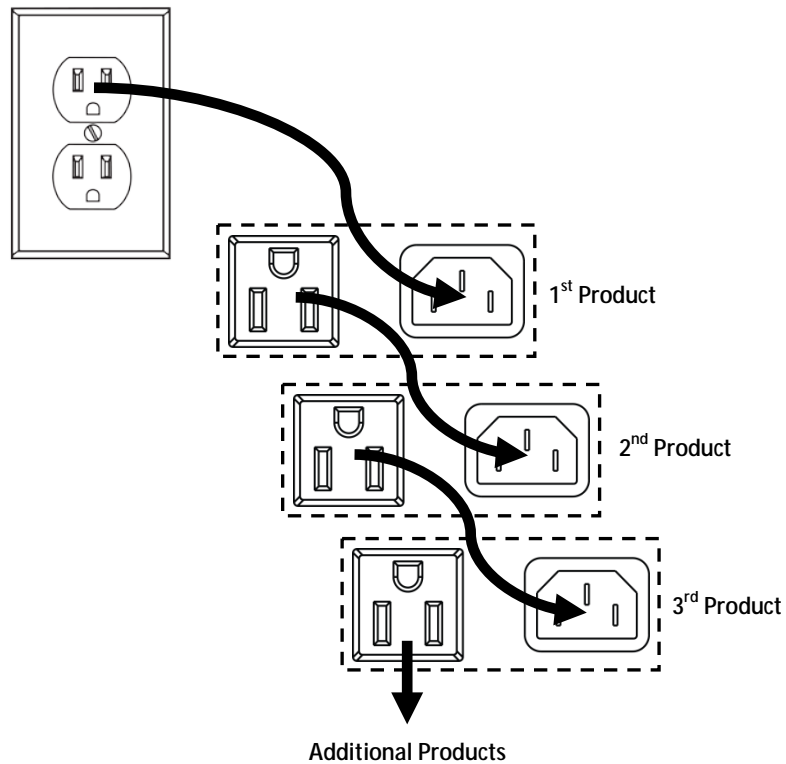

You can power link up to 9 Intimidator™ Spot Duo units on 120 VAC or up to 17 Intimidator™ Spot Duo units on 230 VAC.



The power linking diagram shown above corresponds to the North American version of the product ONLY! If using the product in other markets, you must consult with the local Chauvet distributor as power linking connectors and requirements may differ in your country or region.

Mounting Before mounting the product, read and follow the safety recommendations indicated in the Safety Notes.

Orientation The Intimidator™ Spot Duo may be mounted in any position; however, make sure adequate ventilation is provided around the product.

- Rigging**
- Before deciding on a location, always make sure there is easy access to the product for maintenance and programming.
 - Make sure that the structure or surface onto which you are mounting the product can support the product's weight (see the [Technical Specifications](#)).
 - When mounting the product overhead, always use a safety cable. Mount the product securely to a rigging point, such as an elevated platform or a truss.
 - When rigging the product onto a truss, you should use a mounting clamp of appropriate weight capacity. The bracket has a 13-mm hole, which is appropriate for this purpose.
 - When power linking multiple products, you must always consider the length of the power linking cable and mount the products close enough for the cable to reach.
 - Only loosen or tighten the tripod adjustment knob manually. Using tools could damage the knob.
 - The rubber feet also serve as floor supports. When mounting the product on the floor, make sure that the product and cables are away from people and vehicles.

Mounting Diagram

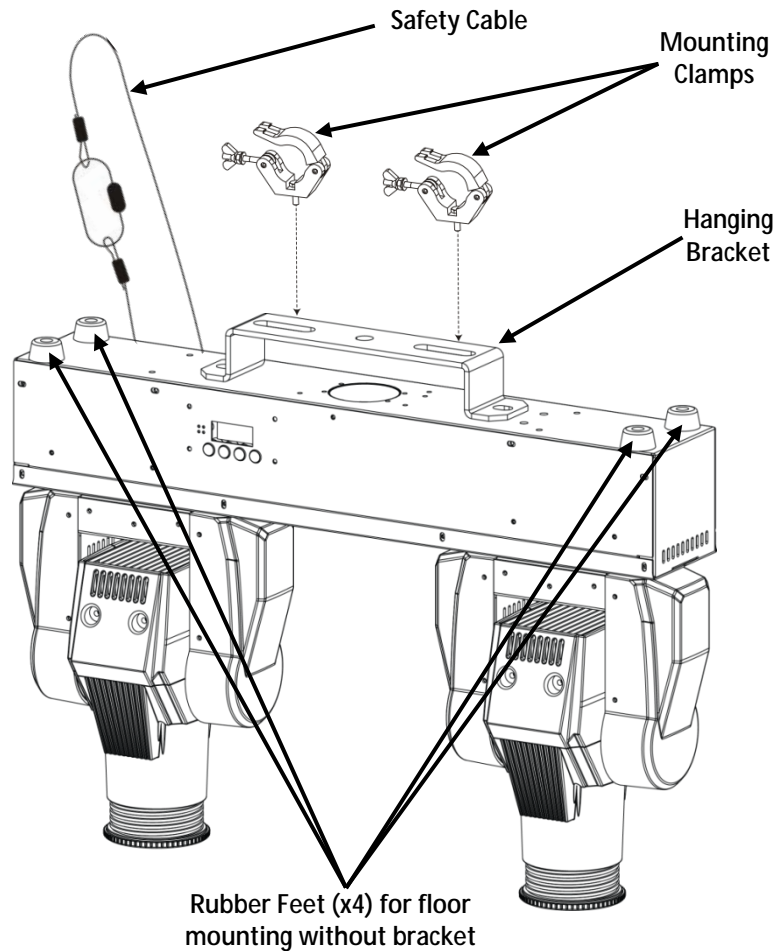

When using only one mounting clamp with this fixture, you must use a clamp with a captive bolt to prevent accidental loosening.

4. OPERATION

Control Panel Operation

To access the control panel functions, use the four buttons located underneath the display.

Button	Function
<MENU>	Selects an operation mode or backs out of the current menu option
<UP>	Scrolls up the list of options or selects a higher value
<DOWN>	Scrolls down the list of options or selects a lower value
<ENTER>	Activates a menu option or a selected value

Menu Map

Modes	Programming Levels	Description
DMX Address	d001—512	Sets the DMX starting address
Automatic	A-01—A-16	Automatic mode
Sound-Active	Srun	Sound-Active mode
Slave	Son1	Slave operating mode 1
	Son2	Slave operating mode 2
Sound Sensitivity	S-01—S-99	Sound sensitivity control
Master Auto	M--4	Master built-in 4-head program
	M--2	Master built-in 2-head program
Pan 1	PA1	Normal pan operation for head 1
	rPA1	Reverse pan operation for head 1
Pan 2	PA2	Normal pan operation for head 2
	rPA2	Reverse pan operation for head 2
Tilt 1	ti1	Normal tilt operation for head 1
	rti1	Reverse tilt operation for head 1
Tilt 2	ti2	Normal tilt operation for head 2
	rti2	Reverse tilt operation for head 2
Display	diS	Normal display
	rDiS	Inverted display
Channel Mode	20CH	20-channel DMX personality
	17CH	17-channel DMX personality
	10CH	10-channel DMX personality
Pan Range	PA36	360° pan range
	PA18	180° pan range
Tilt Range	ti27	270° tilt range
	ti18	180° tilt range
	ti 9	90° tilt range
Temperature Display	t--1 (1txx)	Displays LED temperature for head 1
	t--2 (2txx)	Displays LED temperature for head 2
Reset	rESt	Resets product
Load	LoAd	Loads factory defaults

Configuration (DMX)

Set the product in DMX mode to control with a DMX controller.

1. Connect the product to a suitable power outlet.
2. Connect a DMX cable from the DMX output of the DMX controller to the DMX input socket on the product.

Starting Address

When selecting a starting DMX address, always consider the number of DMX channels the selected DMX mode uses. If you choose a starting address that is too high, you could restrict the access to some of the product's channels.

The Intimidator™ Spot Duo uses up to 20 DMX channels in its 20-channel DMX mode, which defines the highest configurable address to 493.

If unfamiliar with DMX or DIP switches, download the DMX Primer from www.chauvetlighting.com.

To select the starting address, do the following:

1. Press **<MENU>** repeatedly until **d001—d512** shows on the display.
2. Use **<UP>** or **<DOWN>** to select the starting address.
3. Press **<ENTER>**.

DMX Personalities

The Intimidator™ Spot Duo has three DMX personalities: a 10-channel personality, a 17-channel personality, and a 20-channel personality.

To choose a DMX personality, follow the steps below:







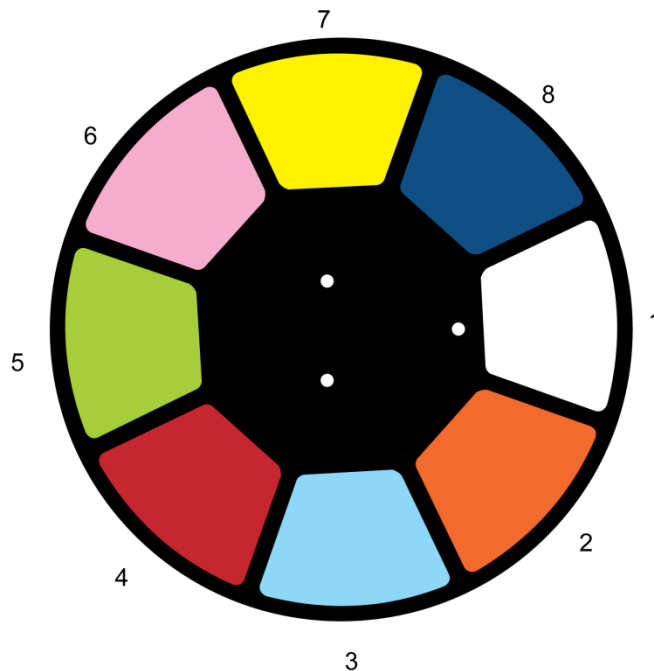













1. Press **<MENU>** repeatedly until **10CH**, **17CH**, or **20CH** shows on the display.
2. Use **<UP>** or **<DOWN>** to select the personality.
3. Press **<ENTER>**.

DMX Channel Modes, Assignments, and Values

20-Channel	Channel	Function	Value	Setting
	1	Pan 1	000 ◊ 255	Pan 0 to 360° for head 1
	2	Fine Pan 1	000 ◊ 255	Fine panning control for head 1
	3	Tilt 1	000 ◊ 255	Tilt 0 to 270° for head 1
	4	Fine Tilt 1	000 ◊ 255	Fine tilting control for head 1
	5	Pan 2	000 ◊ 255	Pan 0 to 360° for head 2
	6	Fine Pan 2	000 ◊ 255	Fine panning control for head 2
	7	Tilt 2	000 ◊ 255	Tilt 0 to 270° for head 2
	8	Fine Tilt 2	000 ◊ 255	Fine tilting control for head 2
	9	Speed	000 ◊ 255	Pan/Tilt speed (fast to slow)
	10	Color Wheel 1 (Head 1)	000 ◊ 015	White
			016 ◊ 031	Orange
			032 ◊ 047	Light Blue
			048 ◊ 063	Red
			064 ◊ 079	Green
			080 ◊ 095	Pink
			096 ◊ 111	Yellow
			112 ◊ 127	Blue
			128 ◊ 191	Rainbow effect with increasing speed
			192 ◊ 255	Reverse rainbow effect with increasing speed
	11	Color Wheel 2 (Head 2)	000 ◊ 015	White
			016 ◊ 031	Orange
			032 ◊ 047	Light Blue
			048 ◊ 063	Red
			064 ◊ 079	Green
			080 ◊ 095	Pink
			096 ◊ 111	Yellow
			112 ◊ 127	Blue
			128 ◊ 191	Rainbow effect with increasing speed
			192 ◊ 255	Reverse rainbow effect with increasing speed



**20-Channel
(cont.)**

Channel	Function	Value	Setting
12	Gobo Wheel 1 (Head 1)	 0-9	 10-15
		 16-21	 22-27
		 28-33	
		 34-39	 40-45
		 46-51	 52-57
		 58-63	
		064 ◊ 069	Gobo 9 shake with increasing speed
		070 ◊ 075	Gobo 8 shake with increasing speed
		076 ◊ 081	Gobo 7 shake with increasing speed
		082 ◊ 087	Gobo 6 shake with increasing speed
		088 ◊ 093	Gobo 5 shake with increasing speed
		094 ◊ 099	Gobo 4 shake with increasing speed
		100 ◊ 105	Gobo 3 shake with increasing speed
		106 ◊ 111	Gobo 2 shake with increasing speed
112 ◊ 117	Gobo 1 shake with increasing speed		
118 ◊ 127	White		
128 ◊ 191	Rainbow effect with increasing speed		
192 ◊ 255	Reverse rainbow effect with increasing speed		
13	Gobo Wheel 2 (Head 2)	 0-9	 10-15
		 16-21	 22-27
		 28-33	
		 34-39	 40-45
		 46-51	 52-57
		 58-63	
		064 ◊ 069	Gobo 9 shake with increasing speed
		070 ◊ 075	Gobo 8 shake with increasing speed
		076 ◊ 081	Gobo 7 shake with increasing speed
		082 ◊ 087	Gobo 6 shake with increasing speed
		088 ◊ 093	Gobo 5 shake with increasing speed
		094 ◊ 099	Gobo 4 shake with increasing speed
		100 ◊ 105	Gobo 3 shake with increasing speed
		106 ◊ 111	Gobo 2 shake with increasing speed
112 ◊ 117	Gobo 1 shake with increasing speed		
118 ◊ 127	White		
128 ◊ 191	Rainbow effect with increasing speed		
192 ◊ 255	Reverse rainbow effect with increasing speed		
14	Dimmer 1	000 ◊ 255	Dimmer for head 1 (0 to 100%)
15	Dimmer 2	000 ◊ 255	Dimmer for head 2 (0 to 100%)



**20-Channel
(cont.)**

Channel	Function	Value	Setting
16	Shutter 1 (Head 1)	000 ó 003	Light off
		004 ó 007	Light on
		008 ó 076	Shutter with increasing speed
		077 ó 145	Pulse strobe
		146 ó 215	Random strobe
		216 ó 255	Light on
17	Shutter 2 (Head 2)	000 ó 003	Light off
		004 ó 007	Light on
		008 ó 076	Shutter with increasing speed
		077 ó 145	Pulse strobe
		146 ó 215	Random strobe
		216 ó 255	Light on
18	Control Functions	000 ó 009	No function
		010 ó 014	Pan/Tilt blackout
		015 ó 019	Color blackout
		020 ó 024	Gobo blackout
		025 ó 029	Pan/Tilt/Color blackout
		030 ó 034	Pan/Tilt/Gobo blackout
		035 ó 039	Color/Gobo blackout
		040 ó 044	Pan/Tilt/Color/Gobo blackout
		045 ó 049	No function
		050 ó 054	First two heads setting
		055 ó 059	Latter two heads setting
		060 ó 064	Cancel four heads
		065 ó 069	No function
		070 ó 074	Reset
		075 ó 079	No function
		080 ó 084	Reverse pan/tilt for both heads
		085 ó 089	Reverse pan for head 1
		090 ó 094	Reverse pan for head 2
		095 ó 099	Reverse tilt for head 1
		100 ó 104	Reverse tilt for head 2
		105 ó 109	Cancel reverse pan for head 1
		110 ó 114	Cancel reverse pan for head 2
		115 ó 119	Cancel reverse tilt for head 1
		120 ó 124	Cancel reverse tilt for head 2
125 ó 129	Cancel reverse pan/tilt for both heads		
130 ó 135	No function		
136 ó 175	Color chase 1 with increasing speed		
176 ó 215	Color chase 2 with increasing speed		
216 ó 255	Color chase 3 with increasing speed		

**20-Channel
(cont.)**

Channel	Function	Value	Setting
19	Movement Macros	000 ó 007	No function
		008 ó 022	Movement macro 1
		023 ó 037	Movement macro 2
		038 ó 052	Movement macro 3
		053 ó 067	Movement macro 4
		068 ó 082	Movement macro 5
		083 ó 097	Movement macro 6
		098 ó 112	Movement macro 7
		113 ó 127	Movement macro 8
		128 ó 142	Movement macro 9
		143 ó 157	Movement macro 10
		158 ó 172	Movement macro 11
		173 ó 187	Movement macro 12
		188 ó 202	Movement macro 13
		203 ó 217	Movement macro 14
		218 ó 232	Movement macro 15
233 ó 247	Movement macro 16		
248 ó 255	Sound-Active program		
20	Movement Macro Speed	000 ó 255	Fast to slow

17-Channel











Channel	Function	Value	Setting		
1	Pan 1	000 ó 255	Pan 0 to 360° for head 1		
2	Fine Pan 1	000 ó 255	Fine panning control for head 1		
3	Tilt 1	000 ó 255	Tilt 0 to 270° for head 1		
4	Fine Tilt 1	000 ó 255	Fine tilting control for head 1		
5	Pan 2	000 ó 255	Pan 0 to 360° for head 2		
6	Fine Pan 2	000 ó 255	Fine panning control for head 2		
7	Tilt 2	000 ó 255	Tilt 0 to 270° for head 2		
8	Fine Tilt 2	000 ó 255	Fine tilting control for head 2		
9	Speed	000 ó 255	Pan/Tilt speed (fast to slow)		
10	Color Wheel (Both Heads)	000 ó 015	White		
		016 ó 031	Orange		
		032 ó 047	Light Blue		
		048 ó 063	Red		
		064 ó 079	Green		
		080 ó 095	Pink		
		096 ó 111	Yellow		
		112 ó 127	Blue		
		128 ó 191	Rainbow effect with increasing speed		
		192 ó 255	Reverse rainbow effect with increasing speed		
11	Gobo Wheel (Both Heads)				
					
		064 ó 069	Gobo 9 shake with increasing speed		
		070 ó 075	Gobo 8 shake with increasing speed		
		076 ó 081	Gobo 7 shake with increasing speed		
		082 ó 087	Gobo 6 shake with increasing speed		
		088 ó 093	Gobo 5 shake with increasing speed		
		094 ó 099	Gobo 4 shake with increasing speed		
		100 ó 105	Gobo 3 shake with increasing speed		
		106 ó 111	Gobo 2 shake with increasing speed		
		112 ó 117	Gobo 1 shake with increasing speed		
		118 ó 127	White		
		128 ó 191	Rainbow effect with increasing speed		
		192 ó 255	Reverse rainbow effect with increasing speed		
		088 ó 093	Gobo 5 shake with increasing speed		
		094 ó 099	Gobo 4 shake with increasing speed		
		100 ó 105	Gobo 3 shake with increasing speed		
		106 ó 111	Gobo 2 shake with increasing speed		
		112 ó 117	Gobo 1 shake with increasing speed		
		118 ó 127	White		
		128 ó 191	Rainbow effect with increasing speed		
		192 ó 255	Reverse rainbow effect with increasing speed		
		12	Dimmer 1	000 ó 255	Dimmer for head 1 (0 to 100%)
		13	Dimmer 2	000 ó 255	Dimmer for head 2 (0 to 100%)

17-Channel (cont.)	Channel	Function	Value	Setting
14	Shutter (Both Heads)		000 ó 003	Light off
			004 ó 007	Light on
			008 ó 076	Shutter with increasing speed
			077 ó 145	Pulse strobe
			146 ó 215	Random strobe
			216 ó 255	Light on
15	Control Functions		000 ó 009	No function
			010 ó 014	Pan/Tilt blackout
			015 ó 019	Color blackout
			020 ó 024	Gobo blackout
			025 ó 029	Pan/Tilt/Color blackout
			030 ó 034	Pan/Tilt/Gobo blackout
			035 ó 039	Color/Gobo blackout
			040 ó 044	Pan/Tilt/Color/Gobo blackout
			045 ó 049	No function
			050 ó 054	First two heads setting
			055 ó 059	Latter two heads setting
			060 ó 064	Cancel four heads
			065 ó 069	No function
			070 ó 074	Reset
			075 ó 079	No function
			080 ó 084	Reverse pan/tilt for both heads
			085 ó 089	Reverse pan for head 1
			090 ó 094	Reverse pan for head 2
			095 ó 099	Reverse tilt for head 1
			100 ó 104	Reverse tilt for head 2
			105 ó 109	Cancel reverse pan for head 1
			110 ó 114	Cancel reverse pan for head 2
			115 ó 119	Cancel reverse tilt for head 1
			120 ó 124	Cancel reverse tilt for head 2
	125 ó 129	Cancel reverse pan/tilt for both heads		
	130 ó 135	No function		
	136 ó 175	Color chase 1 with increasing speed		
	176 ó 215	Color chase 2 with increasing speed		
	216 ó 255	Color chase 3 with increasing speed		

**17-Channel
(cont.)**

Channel	Function	Value	Setting
16	Movement Macros	000 ó 007	No function
		008 ó 022	Movement macro 1
		023 ó 037	Movement macro 2
		038 ó 052	Movement macro 3
		053 ó 067	Movement macro 4
		068 ó 082	Movement macro 5
		083 ó 097	Movement macro 6
		098 ó 112	Movement macro 7
		113 ó 127	Movement macro 8
		128 ó 142	Movement macro 9
		143 ó 157	Movement macro 10
		158 ó 172	Movement macro 11
		173 ó 187	Movement macro 12
		188 ó 202	Movement macro 13
		203 ó 217	Movement macro 14
		218 ó 232	Movement macro 15
233 ó 247	Movement macro 16		
248 ó 255	Sound-Active program		
17	Movement Macro Speed	000 ó 255	Fast to slow

10-Channel

Channel	Function	Value	Setting
1	Pan	000 ó 255	Pan 0—360° for both heads
2	Tilt	000 ó 255	Tilt 0—270° for both heads
3	Color Wheel (Both Heads)	000 ó 015	White
		016 ó 031	Orange
		032 ó 047	Light Blue
		048 ó 063	Red
		064 ó 079	Green
		080 ó 095	Pink
		096 ó 111	Yellow
		112 ó 127	Blue
		128 ó 191	Rainbow effect with increasing speed
		192 ó 255	Reverse rainbow effect with increasing speed
4	Gobo Wheel (Both Heads)		0–9
			10–15
			16–21
			22–27
			28–33
			34–39
			40–45
			46–51
			52–57
			58–63
		064 ó 069	Gobo 9 shake with increasing speed
		070 ó 075	Gobo 8 shake with increasing speed
		076 ó 081	Gobo 7 shake with increasing speed
		082 ó 087	Gobo 6 shake with increasing speed
		088 ó 093	Gobo 5 shake with increasing speed
		094 ó 099	Gobo 4 shake with increasing speed
		100 ó 105	Gobo 3 shake with increasing speed
		106 ó 111	Gobo 2 shake with increasing speed
		112 ó 117	Gobo 1 shake with increasing speed
		118 ó 127	White
		128 ó 191	Rainbow effect with increasing speed
		192 ó 255	Reverse rainbow effect with increasing speed
		088 ó 093	Gobo 5 shake with increasing speed
		094 ó 099	Gobo 4 shake with increasing speed
		100 ó 105	Gobo 3 shake with increasing speed
		106 ó 111	Gobo 2 shake with increasing speed
		112 ó 117	Gobo 1 shake with increasing speed
		118 ó 127	White
128 ó 191	Rainbow effect with increasing speed		
192 ó 255	Reverse rainbow effect with increasing speed		
5	Dimmer 1	000 ó 255	Dimmer for head 1 (0 to 100%)
6	Dimmer 2	000 ó 255	Dimmer for head 2 (0 to 100%)
7	Shutter (Both Heads)	000 ó 003	Light off
		004 ó 007	Light on
		008 ó 076	Shutter with increasing speed
		077 ó 145	Pulse strobe
		146 ó 215	Random strobe
		216 ó 255	Light on

10-Channel (cont.)	Channel	Function	Value	Setting
			000 ó 009	No function
			010 ó 014	Pan/Tilt blackout
			015 ó 019	Color blackout
			020 ó 024	Gobo blackout
			025 ó 029	Pan/Tilt/Color blackout
			030 ó 034	Pan/Tilt/Gobo blackout
			035 ó 039	Color/Gobo blackout
			040 ó 044	Pan/Tilt/Color/Gobo blackout
			045 ó 049	No function
			050 ó 054	First two heads setting
			055 ó 059	Latter two heads setting
			060 ó 064	Cancel four heads
			065 ó 069	No function
			070 ó 074	Reset
	8	Control Functions	075 ó 079	No function
			080 ó 084	Reverse pan/tilt for both heads
			085 ó 089	Reverse pan for head 1
			090 ó 094	Reverse pan for head 2
			095 ó 099	Reverse tilt for head 1
			100 ó 104	Reverse tilt for head 2
			105 ó 109	Cancel reverse pan for head 1
			110 ó 114	Cancel reverse pan for head 2
			115 ó 119	Cancel reverse tilt for head 1
			120 ó 124	Cancel reverse tilt for head 2
			125 ó 129	Cancel reverse pan/tilt for both heads
			130 ó 135	No function
			136 ó 175	Color chase 1 with increasing speed
			176 ó 215	Color chase 2 with increasing speed
			216 ó 255	Color chase 3 with increasing speed

**10-Channel
(cont.)**

Channel	Function	Value	Setting
9	Movement Macros	000 ó 007	No function
		008 ó 022	Movement macro 1
		023 ó 037	Movement macro 2
		038 ó 052	Movement macro 3
		053 ó 067	Movement macro 4
		068 ó 082	Movement macro 5
		083 ó 097	Movement macro 6
		098 ó 112	Movement macro 7
		113 ó 127	Movement macro 8
		128 ó 142	Movement macro 9
		143 ó 157	Movement macro 10
		158 ó 172	Movement macro 11
		173 ó 187	Movement macro 12
		188 ó 202	Movement macro 13
		203 ó 217	Movement macro 14
		218 ó 232	Movement macro 15
233 ó 247	Movement macro 16		
248 ó 255	Sound-Active program		
10	Movement Macro Speed	000 ó 255	Fast to slow

Configuration (Standalone)

Set the product in one of the standalone modes to control without a DMX controller.

- Connect the product to a suitable power outlet.



Never connect a product that is operating in any standalone mode (Static, Automatic, or Sound-Active) to a DMX string connected to a DMX controller. Products in standalone mode may transmit DMX signals that could interfere with the DMX signals from the controller.

Sound-Active Mode

To enable the Sound-Active mode, do the following:

1. Press **<MENU>** repeatedly until **Srun** shows on the display.
2. Press **<ENTER>**.

Sound Sensitivity

To set the sound sensitivity, follow the instructions below:

1. Press **<MENU>** repeatedly until **S-01—S-99** shows on the display.
2. Use **<UP>** or **<DOWN>**: to select the desired sound sensitivity.
3. Press **<ENTER>**.



The product will only respond to low frequencies of music (bass and drums).

Automatic Mode

To enable the Automatic mode, do the following:

1. Press **<MENU>** repeatedly until **A-01—A-16** shows on the display.
2. Use **<UP>** or **<DOWN>** to select the desired auto program.
3. Press **<ENTER>**.

Pan Operation To select whether you want the Intimidator™ Spot Duo to operate with normal panning or inverted panning, do the following:

Head 1:

1. Press **<MENU>** repeatedly until **PA1** (normal pan operation) or **rPA1** (reverse pan operation) shows on the display.
2. Use **<UP>** or **<DOWN>** to select the desired pan operation.
3. Press **<ENTER>**.

Head 2:

Repeat steps 1 to 3 with the options **PA2** and **rPA2** for Head 2's pan operation.

Tilt Operation To select whether you want the Intimidator™ Spot Duo to operate with normal tilting or inverted tilting, do the following:

Head 1:

1. Press **<MENU>** repeatedly until **ti1** (normal tilt operation) or **rti1** (reverse tilt operation) shows on the display.
2. Use **<UP>** or **<DOWN>** to select the desired tilt operation.
3. Press **<ENTER>**.

Head 2:

Repeat steps 1 to 3 with the options **ti2** and **rti2** for Head 2's tilt operation.

Pan/Tilt Angle Range You are able to select the range for the pan and tilt angles on the Intimidator™ Spot Duo to achieve the effect you like.

To select which pan angle range to use, follow the instructions below.

1. Press **<MENU>** repeatedly until either **PA36** (0 to 360° range) or **PA18** (0 to 180° range) shows on the display.
2. Use **<UP>** or **<DOWN>** to select the desired pan range.
3. Press **<ENTER>**.

To select which tilt angle range to use, do the following.

1. Press **<MENU>** repeatedly until **ti27** (0 to 270°), **ti18** (0 to 180°), or **ti 9** (0 to 90°) shows on the display.
2. Use **<UP>** or **<DOWN>** to select the desired tilt range.
3. Press **<ENTER>**.

Display You are able to flip the display for easy readability in any mounting situation.

To select your display angle:

1. Press **<MENU>** repeatedly until **diS** (normal display) or **rdiS** (inverted display) shows on the display.
2. Press **<UP>** or **<DOWN>** to select desired display.
3. Press **<ENTER>**.

Temperature Display To view the LED's temperature for Head 1 and Head 2, do the following:

1. Press **<MENU>** repeatedly until **t--1** (Head 1's temperature) or **t--2** (Head 2's temperature) shows on the display.
2. Press **<ENTER>**.

Reset Software To reset the software on the Intimidator™ Spot Duo, do the following:

1. Press **<MENU>** and until **rESt** shows on the display.
2. Press **<ENTER>**.

Load Factory Defaults To load the factory default settings on the Intimidator™ Spot Duo, do the following:

1. Press **<MENU>** and until **LoAd** shows on the display.
2. Press **<ENTER>**.

Master Auto Programs

The Master Auto built-in programs control the actions of two Intimidator™ Spot Duo units linked together by DMX data connection. A single Intimidator™ Spot Duo (the master) controls the actions of another Intimidator™ Spot Duo (the slave). Configure the Master Auto programs in conjunction with the Slave modes as follows.

Master Auto 4-Head Program

The Master Auto 4-Head program allows all 4 heads of two linked Intimidator™ Spot Duo units to operate in unison. The master unit will be set to operate in the **M--4** program, while the slave unit will be set to operate in either **Son1** or **Son2** mode.

Configure the units as indicated below.

Master unit:

1. Press **<MENU>** repeatedly until **M--2** or **M--4** shows on the display.
2. If it is not already selected, use **<UP>** or **<DOWN>** to select **M--4**.
3. Press **<ENTER>**.

Slave unit:

1. Press **<MENU>** repeatedly until **Son1** or **Son2** shows on the display.
2. Use **<UP>** or **<DOWN>** to select either **Son1** or **Son2**.
 - Select **Son1** for 100% synchronized actions.
 - Select **Son2** for a delayed show with all 4 heads in the same direction.
3. Press **<ENTER>**.



- **Configure all the slave units before connecting the master unit to the DMX daisy chain.**
- **Never connect a DMX controller to a DMX string configured for Master/Slave operation because the controller may interfere with the signals from the master unit.**
- **Do not connect more than 31 slave units to the master unit.**

Master Auto 2-Head Program

The Master Auto 2-Head program allows a single Intimidator™ Spot Duo to control the actions of another Intimidator™ Spot Duo. The master unit will be set to operate in the **M--2** program, while the slave unit will be set to operate in either **Son1** or **Son2** mode.

Configure the units as indicated below.

Master unit:

1. Press **<MENU>** repeatedly until **M--2** or **M--4** shows on the display.
2. If it is not already selected, use **<UP>** or **<DOWN>** to select **M--2**.
3. Press **<ENTER>**.

Slave unit:

1. Press **<MENU>** repeatedly until **Son1** or **Son2** shows on the display.
2. Press **<UP>** or **<DOWN>** to select either **Son1** or **Son2**.
 - Select **Son1** for 100% synchronized actions.
 - Select **Son2** for the same show with both units, but the actions of the slave are in the opposite direction of the actions of the master.
3. Press **<ENTER>**.



- **Configure all the slave units before connecting the master unit to the DMX daisy chain.**
- **Never connect a DMX controller to a DMX string configured for Master/Slave operation because the controller may interfere with the signals from the master unit.**
- **Do not connect more than 31 slave units to the master unit.**

5. TECHNICAL INFORMATION

Product Maintenance

Dust build-up reduces light output performance and can cause overheating. This can lead to reduction of the light source's life and mechanical wear. To maintain optimum performance and minimize wear, clean the product at least twice a month. However, usage and environmental conditions contribute to increased cleaning frequency.

To clean the product, follow the instructions below:

1. Unplug the product from power.
2. Wait until the product is at room temperature.
3. Use a vacuum (or dry compressed air) and a soft brush to remove dust collected on the external surface/vents and reachable internal components.
4. Clean all external optics and glass/transparent surfaces with a mild soap solution, ammonia-free glass cleaner, or isopropyl alcohol.
5. Apply the solution directly to a soft, lint-free cotton cloth or a lens cleaning tissue.
6. Softly wipe any dirt or grime to the outside edges of the external optics or glass/transparent surface.
7. Gently polish the external optics and glass/transparent surfaces until they are free of haze and lint.



Always dry the external optics and glass/transparent surfaces carefully after cleaning them.



Do not spin the cooling fan using compressed air because you could damage it.

6. TECHNICAL SPECIFICATIONS

Dimensions and Weight	Length	Width	Height	Weight
	21 in (540 mm)	7.4 in (187 mm)	14.4 in (365 mm)	18.4 lb (8.4 kg)
Note: Dimensions in inches rounded to the nearest decimal digit.				
Power	Power Supply Type	Range	Voltage Selection	
	Switching (internal)	100 to 240 VAC, 50/60 Hz	Auto-ranging	
	Parameter	120 V, 60 Hz	230 V, 50 Hz	
	Consumption	98 W	104 W	
	Operating current	0.8 A	0.4 A	
	Power linking current (units)	8 A (9 units)	8 A (17 units)	
	Fuse	F 3 A, 250 V	F 3 A, 250 V	
Light Source (per Head)	Power I/O	US/Worldwide	UK/Europe	
	Power input connector	IEC	IEC	
	Power output connector	Edison	IEC	
	Power Cord plug	Edison (US)	Local plug	
Light Source (per Head)	Type	Power	Lifespan	
	LED	10 W	50,000 hours	
Photo Optic (per Head)	Color	Quantity	Current	
	White	1	2.8 A	
	Parameter			
	Illuminance @ 2 m	10,900 lx		
	Beam angle	6°		
	Strobe rate	0 to 17 Hz		
	Pan & Tilt	360° Pan	270° Tilt	
	Pan/Tilt Ranges	360°, 180° Pan	270°, 180°, 90° Tilt	
Thermal	Maximum External Temp.	Cooling System		
	104 °F (40 °C)	Fan-cooled		
DMX	I/O Connectors	Connector Type	Channel Range	
	3-pin XLR	Sockets	10, 17, 20	
Ordering	Product Name	Item Code	UPC Number	
	Intimidator™ Spot Duo	08010652	781462210007	

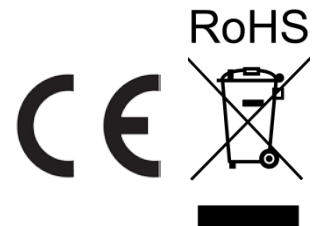

Returns

To return a product or request support:

- In the U.S., contact Chauvet World Headquarters (See [Contact Us](#)).
- In the UK or Ireland, contact Chauvet Europe Ltd. (See [Contact Us](#)).
- In Mexico, contact Chauvet Mexico. (See [Contact Us](#)).
- In any other country, DO NOT contact Chauvet. Instead, contact your lighting distributor. See www.chauvetlighting.com for distributors outside the U.S., UK, Mexico, or Ireland.



Outside the U.S., UK, Ireland, or Mexico, contact your distributor and follow their instructions on how to return Chauvet products to them. Visit our website for contact details.

Call the corresponding Chauvet Technical Support office and request a Return Merchandise Authorization (RMA) number before shipping the product. Be prepared to provide the model number, serial number, and a brief description of the cause for the return.

You must send the merchandise prepaid, in its original box, and with its original packing and accessories. Chauvet will not issue call tags.

Clearly label the package with the RMA number. Chauvet will refuse any product returned without an RMA number.



Write the RMA number on a properly affixed label. DO NOT write the RMA number directly on the box.

Before sending the product, clearly write the following information on a piece of paper and place it inside the box:

- Your name
- Your address
- Your phone number
- RMA number
- A brief description of the problem

Be sure to pack the product properly. Any shipping damage resulting from inadequate packaging will be your responsibility. FedEx packing or double-boxing are recommended.



Chauvet reserves the right to use its own discretion to repair or replace returned product(s).

CONTACT US

WORLD HEADQUARTERS - Chauvet

General Information

Address: 5200 NW 108th Avenue
Sunrise, FL 33351
Voice: (954) 577-4455
Fax: (954) 929-5560
Toll free: (800) 762-1084

Technical Support

Voice: (954) 577-4455 (Press 4)
Fax: (954) 756-8015
Email: tech@chauvetlighting.com

World Wide Web www.chauvetlighting.com

UNITED KINGDOM AND IRELAND - Chauvet Europe Ltd.

General Information

Address: Unit 1C
Brookhill Road Industrial Estate
Pinxton, Nottingham, UK
NG16 6NT
Voice: +44 (0)1773 511115
Fax: +44 (0)1773 511110

Technical Support

Email: uktech@chauvetlighting.com

World Wide Web www.chauvetlighting.co.uk

MEXICO - Chauvet Mexico

General Information

Address: Av. Santa Ana 30
Parque Industrial Lerma
Lerma, Mexico C.P. 52000
Voice: +52 (728) 285-5000

Technical Support

Email: servicio@chauvet.com.mx

World Wide Web www.chauvet.com.mx

Outside the U.S., United Kingdom, Ireland, or Mexico, contact the dealer of record and follow their instructions to request support or to return a product. Visit the Chauvet website for contact information.