

Power Steering Pump Service Manual

PS SERIES



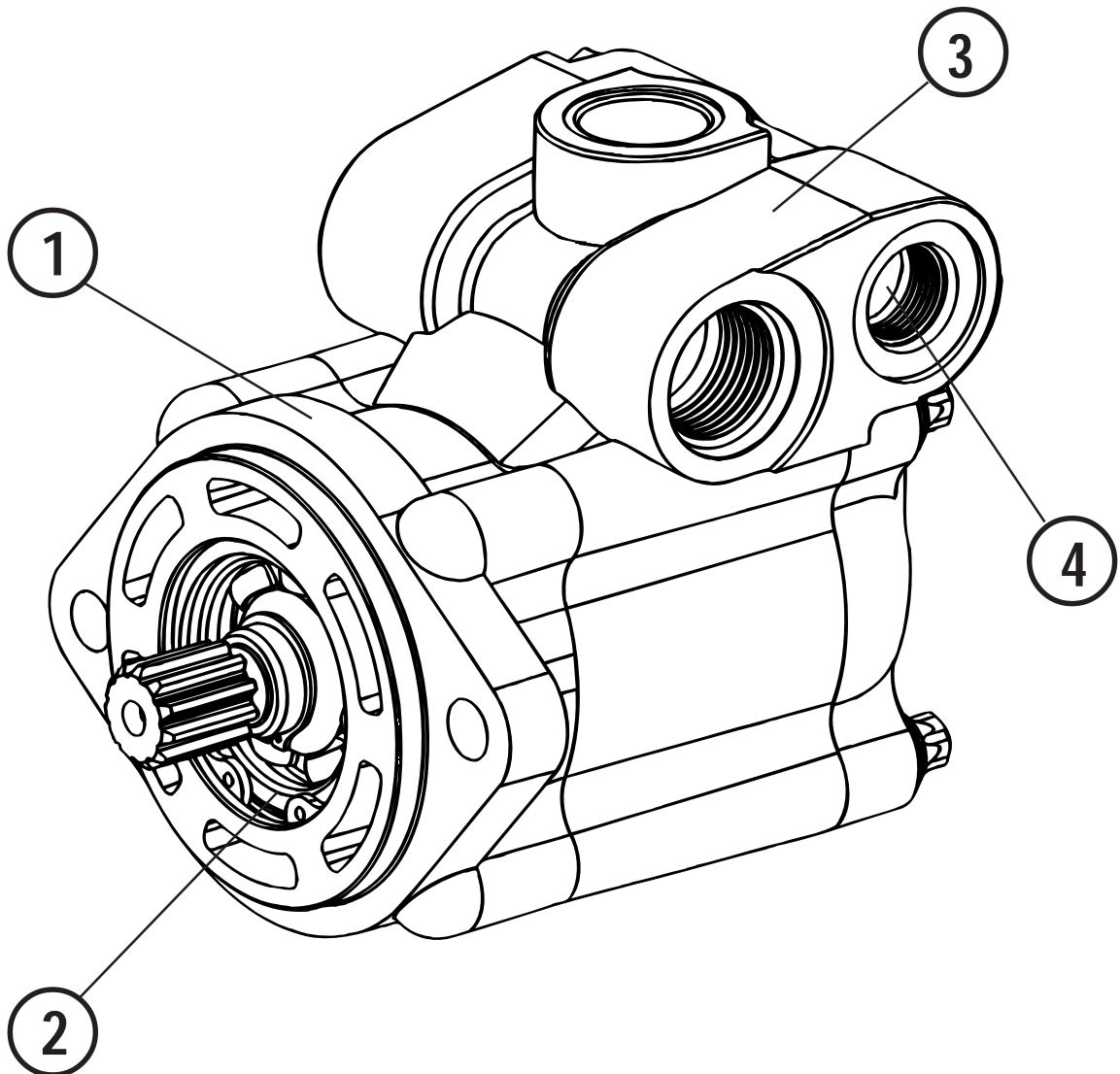

Design Features

- ① Cover rotatable in 90 degree increments
 - ② Heavy duty bearing package
 - ③ Lightweight aluminum housing (overall weight approx. 7.2 lbs.)
 - ④ Flow control valve compatible with TAS steering gear
- Made in the USA
 - Three inlet port locations
 - Two outlet port locations
 - Three displacements available in a single housing size
 - Only two housing castings needed
 - Short pump overall length
 - Seals are all high temperature capable (not to exceed 250° F.)



Hazard Warning Definitions

 WARNING	A warning describes hazards or unsafe practices which could result in severe personal injury or death.
 CAUTION	A caution describes hazards or unsafe practices which could result in personal injury or product or property damage.
NOTE	A note gives key information to make following a procedure easier or quicker.

Disclaimer

This Service Manual has been prepared by TRW Commercial Steering Division for reference and use by mechanics who have been trained to repair and service steering components and systems on heavy commercial vehicles. TRW Commercial Steering Division has exercised reasonable care and diligence to present accurate, clear and complete information and instructions regarding the TRW Commercial Steering PS Series Power Steering Pumps. Since this is a general Service Manual, the photographs and illustrations may not look exactly like the pump being serviced. The procedures, therefore, must be carefully read and understood before servicing.

If inspection or testing reveals evidence of abnormal wear or damage to the PS pump or if you encounter circumstances not covered in the Manual, STOP - CONSULT THE VEHICLE MANUFACTURER'S SERVICE MANUAL AND WARRANTY. DO NOT TRY TO REPAIR OR SERVICE A PS POWER STEERING PUMP WHICH HAS BEEN DAMAGED OR INCLUDES ANY PART THAT SHOWS EXCESSIVE WEAR UNLESS THE DAMAGED AND WORN PARTS ARE REPLACED WITH ORIGINAL TRW REPLACEMENT AND SERVICE PARTS AND THE UNIT IS RESTORED TO TRW'S SPECIFICATIONS FOR THE PS POWER STEERING PUMP.

It is the responsibility of the mechanic performing the maintenance, repairs or service on a particular PS power steering pump to (a) inspect the pump for abnormal wear and damage, (b) choose a repair procedure which will not endanger his/her safety, the safety of others, the vehicle, or the safe operation of the vehicle, and (c) fully inspect and test the PS pump and the vehicle steering system to ensure that the repair or service of the pump has been properly performed and that the pump and system will function properly.

Patents

TRW Commercial Steering Division PS Power Steering Pumps are covered by several United States and foreign patents, either issued or pending.

Contents

Section 1	General Information	
	Introduction	6
	General Design & Operation	7
	Oil Flow Illustration	8
	Approved Hydraulic Fluids	8
	Torque Chart	9
	Pump Specification Numbers	9
	Service Parts List	10
	Exploded View	11
	Part Number Breakdown	12
Section 2	Initial Installation	
	Installation	14
	Maintenance Tips	15
Section 3	Reseal & Repair	
	Disassembly	17
	Inspection	23
	Assembly	25
	Internal Damage Repair (by reference)	
	Input shaft Replacement	31
	Needle Bearing Removal	32
Section 4	Reinstallation	
	Reinstallation	34
	Filling and Air Bleeding the System	35
	Maintenance Tips	36
Section 5	Glossary	
	Glossary	38

 WARNING	All steering mechanisms are safety critical items. As such, it is imperative that the instructions in this booklet be followed to the letter. Failure to observe the procedures set forth in this pamphlet may result in a loss of steering.
--	--

Section 1

General Information

Introduction	6
General Design & Operation	7
Oil Flow Illustration	8
Approved Hydraulic Fluids	8
Torque Chart	9
Pump Specification Numbers	9
Service Parts List	10
Exploded View	11
Part Number Breakdown	12

Introduction

The three-column format used in the Service Manual will help make it easy for you to service a power steering pump. Column 1 illustrates the procedure with photographs, column 2 gives a brief key as well as tools to be used for each procedure, and column 3 explains in detail the procedure you should follow. **Pay special attention to the notes, cautions and warnings.**

The exploded view is on a fold-out page so you can see it while reading through the procedures. Item numbers on the exploded view correspond with item numbers used throughout the Service Manual.

As you gain experience in servicing PS power steering pumps, you may find that some information in this Service Manual could be clearer and more complete. If so, let us know about it. Don't try to second-guess the Service Manual; if you do not understand a procedure, or are stuck, contact our Field Service Department at 1-800-572-3957. Servicing PS power steering pumps should be safe and productive.

General Design

Description of the TRW Commercial Steering Division Power Steering Pump

The PS power steering pump is a balanced, positive displacement, sliding vane type, two line pump with an internal pilot operated flow control and relief valve. The components of this description are broken down and explained below:

Balanced

The pumping element has two pumping pockets opposed 180° from each other which balance the internal forces due to the pressure generated by the pumping action.

Positive Displacement

The pump will output a fixed volume for each revolution of the input shaft. This fixed volume is determined by the internal contour of the cam ring.

Sliding Vane Type

This describes the type of pumping element. The PS pumping element consists of three components.

- 1 The rotor that holds the vanes and is driven by the engine with the pump input shaft.
- 2 The vanes that slide back and forth in slots in the rotor while following the internal contour of the cam ring as the rotor is being turned, thus a sliding vane.

- 3 The cam ring that contains the internal contour that defines the amount of fluid that is output with each revolution of the rotor.

Two Line

The PS pump requires an inlet line to supply oil to the pump and an outlet line to take the oil supplied by the pump to the steering gear. All excess, (bypass), oil is diverted internally in the pump housing back to the inlet of the pumping element. Other systems may have a third line which takes this excess oil back to the reservoir.

Internal Flow Control Valve

The pump has a pilot operated valve built into the pump housing that will control the amount of oil that is output to the steering gear. This allows the output flow to remain within specification for almost any input speed variation.

Relief Valve

The pump has a pilot operated relief valve built into the flow control valve spool which will limit the maximum pressure the pump can produce. When the pressure limit has been reached, the relief section will cause the flow control to bypass more oil internal to the pump, limiting the outlet pressure.

General Operation

What is a Power Steering Pump?

The pump is the heart of the hydraulic steering system. It converts the rotational energy supplied by the engine into hydraulic energy, flow and pressure, for use by the steering gear.

Theory of Operation

All pumps function by creating a partial vacuum at the inlet, which causes atmospheric pressure to force fluid into the pump from the reservoir. The pump then pushes this fluid into the system for use. The fluid is used to power the steering gear. Pump output flow relates to steering gear speed and pump output pressure relates to steering gear force (work).

Oil Flow Illustration

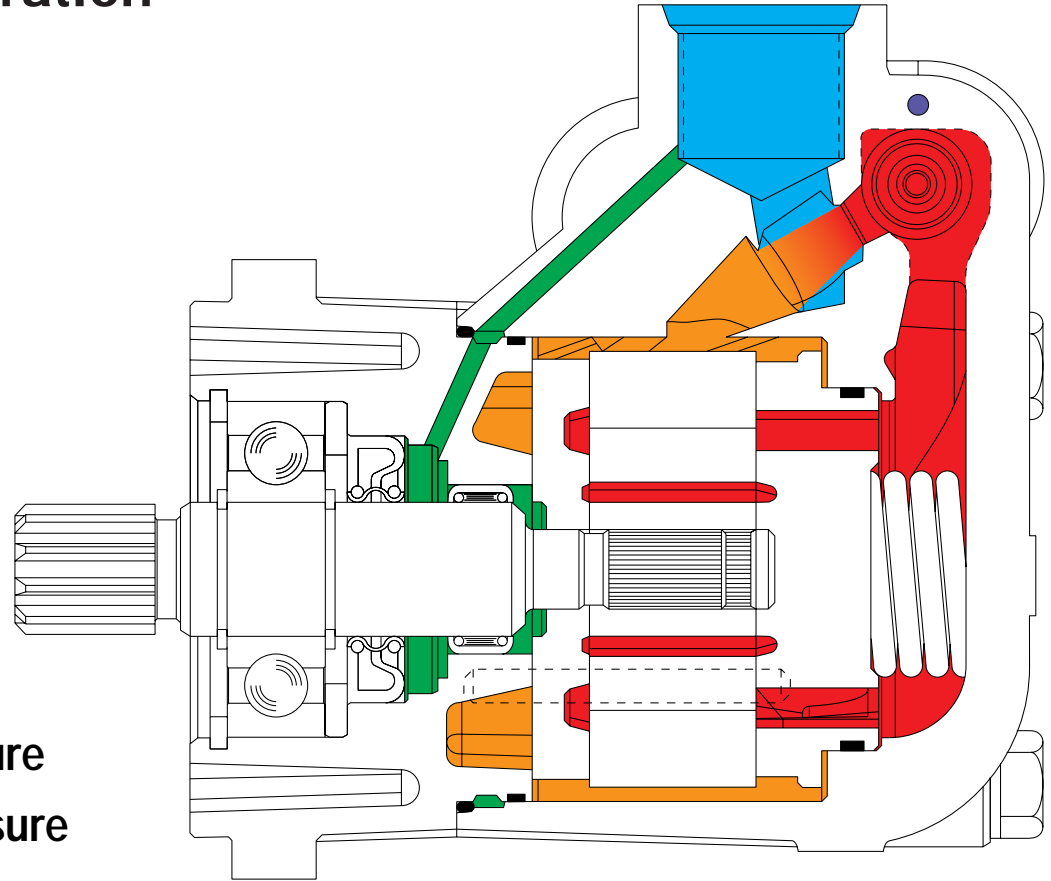

- Inlet Pressure
- Boost Pressure
- Outlet Pressure
- Seal Drain
- Pilot Pressure

Approved Hydraulic Fluids

Automatic Transmission Fluid Dexron II
Automatic Transmission Fluid Type "E" or "F"
Chevron 10W-40
Chevron Custom 10W-40 Motor Oil
Chevron Torque 5 Fluid
Exxon Nuto H32 Hydraulic Fluid
Fleetrite PSF (Can #990625C2)
Ford Spec. M2C138CJ

Mack EO-K2 Engine Oil
Mobil ATF 210
Mobil Super 10W-40 Motor Oil
Texaco 10W-40
Texaco TL-1833 Power Steering Fluid
Union 10W-40
Union 15W-40
Unocal Guardon 15W-40 Motor Oil

The steering system should be kept filled with one of the above fluids.

⚠ WARNING Completely flush the steering system with one of the recommended fluids above only. Do not mix oil types. Any mixture or any unapproved oil could lead to seal deterioration and leaks. A leak could ultimately cause the loss of fluid, which could result in a loss of power steering assist.

Torque Chart

Part Name	Item #	Torque Range Dry	Torque Range Lubricated
Bolts (4)	4	20-30 lbf•ft (27-41 N•M)	15-25 lbf•ft (20-34 N•M)
Relief valve seat assembly	6E	7-15 lbf•ft (9-20 N•M)	
Plug	9		
Pressure port (outlet)		37 lbf•ft maximum (50 N•M)	
Suction port (inlet)		74 lbf•ft maximum (100 N•M)	

Item numbers referenced are shown on the exploded view, pages 7A & 7B.

Specification Numbers

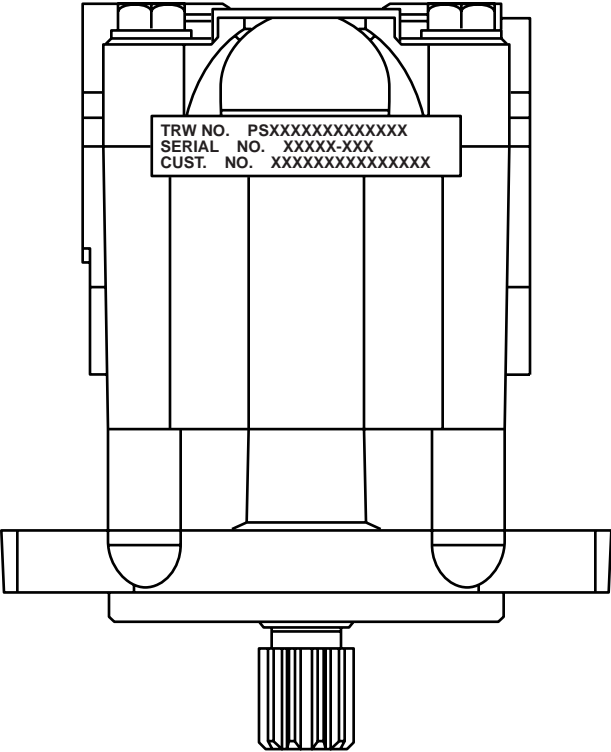

The PS power steering pump TRW part number, serial number, and customer part number are stamped on a machined surface located on the bottom of the pump, opposite the valve spool.

Service Parts List

<u>Item</u>	<u>Description</u>	<u>Part Number</u>
28	Input shaft (11 tooth)	086128
28	Input shaft (woodruff key)	086129
	Seal Kit (includes following parts)	SK000131
8	O-ring	032845
11	O-ring	032844
12	Backup ring	032846
19	O-ring	032843
20	O-ring	032842
23	Shaft seal	032847
	Shaft seal grease	

PS Series Exploded View -- Typical

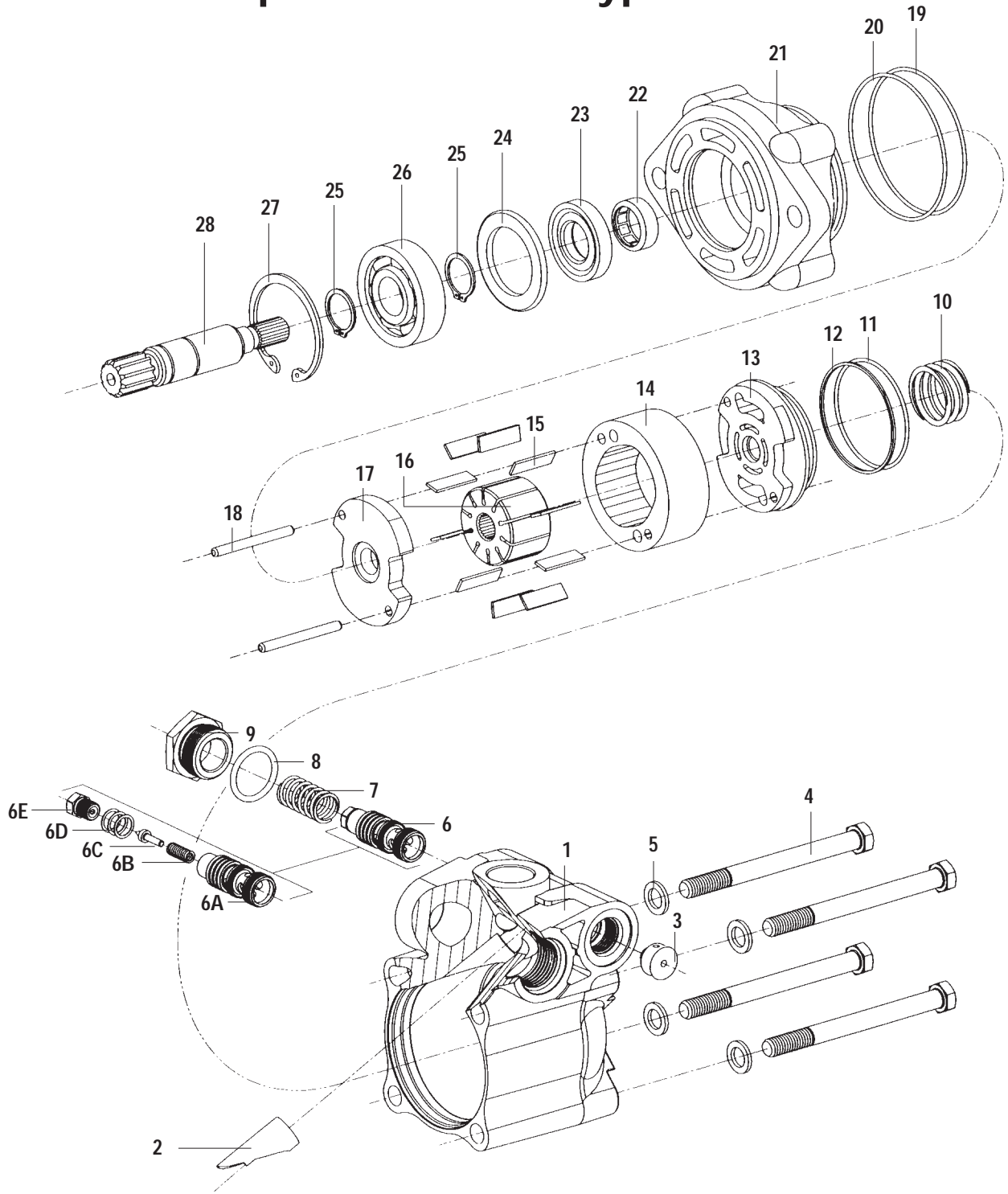

- | | | | | | |
|----|----------------------------|----|--------------|----|--------------------|
| 1 | Housing | 7 | Spring | 18 | Locating pins |
| 2 | Boost tube | 8 | O-ring | 19 | O-ring |
| 3 | Orifice | 9 | Plug | 20 | O-ring |
| 4 | Bolts | 10 | Spring | 21 | Cover |
| 5 | Washers | 11 | O-ring | 22 | Needle bearing |
| 6 | Valve spool assembly | 12 | Backup ring | 23 | Shaft seal |
| 6A | Spool | 13 | Top plate | 24 | Spacer |
| 6B | Spring | 14 | Cam ring | 25 | Retaining ring (2) |
| 6C | Poppet | 15 | Vanes | 26 | Ball bearing |
| 6D | Shims | 16 | Rotor | 27 | Retaining ring |
| 6E | Relief valve seat assembly | 17 | Bottom plate | 28 | Input shaft |

Part Number

PS 18 12 15 R 1 01 00

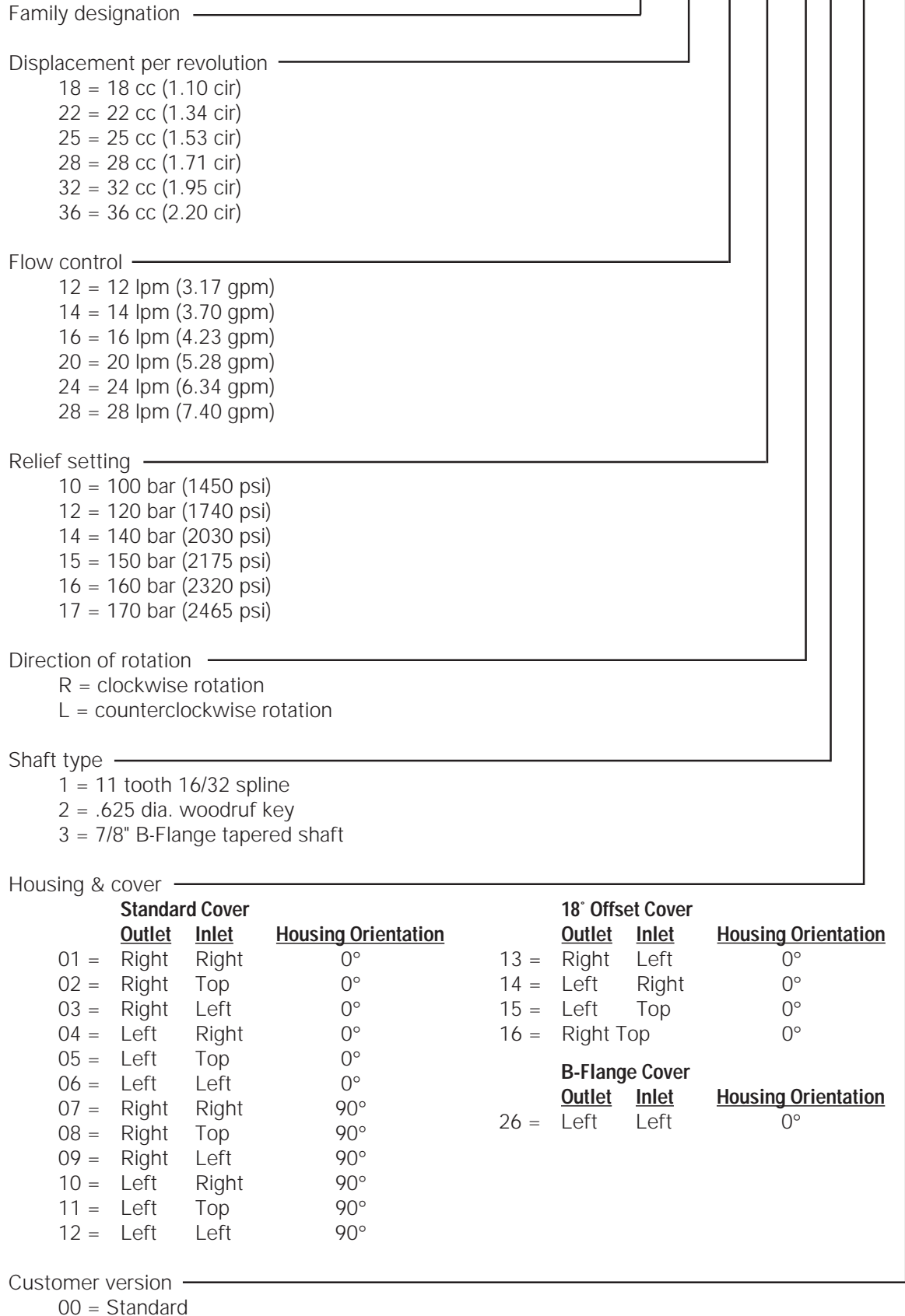

Section 2

Initial Installation

Installation 14

Maintenance Tips 15

Initial PS Installation

1. Install fittings to input and output ports, if fittings for this application can be preinstalled.
2. Install a gear on the input shaft, if required for this application.
3. Install the retaining nut, if required for this application, and torque to the manufacturer's specification.
4. Position either a gasket or o-ring, dependent on the application, which will seal the pump face to the mounting surface.
5. Engage the input shaft.
6. Tighten the mounting bolts to manufacturer's specifications.
7. Connect the input and output lines.
8. Fill the reservoir.
9. Start the vehicle to purge the system.
10. Turn off the vehicle and check the fluid level in the reservoir. Add fluid as necessary.
11. Bleed the system if necessary using instructions on page 36.

Maintenance Tips

Never high-pressure wash or steam clean a power steering pump while off the vehicle. Doing so could force contaminants inside the pump and cause it to malfunction.

Always **clean off around the reservoir filler cap** before you remove it. Prevent dirt or other foreign matter from entering the hydraulic system.

Regularly check the fluid and the fluid level in the power steering reservoir.

Investigate and correct any external leaks, no matter how minor.

Encourage drivers to report any malfunctions or accidents which could have damaged steering components.

Replace reservoir filters according to requirements.

Do not attempt to weld any broken steering component. Replace the component with original equipment only.

If you feel the vehicle is developing excessively **high hydraulic fluid temperatures**, consult with your vehicle manufacturer for recommendations.

Do not cold-straighten, hot straighten, or bend any steering system component.

Section 3

Reseal & Repair

Disassembly	17
Inspection	23
Assembly	25
Internal Damage Repair (by reference)	
Input Shaft Replacement	31
Needle Bearing Removal	32

Disassembly Preparation

Stop the vehicle with wheels pointed straight ahead.

Clean off all outside dirt from around fittings and hose connections before you remove the pump.

Remove the pump from the vehicle and take it to a clean work surface.

Clean and dry the pump before you start to disassemble it.

As you disassemble the pump, clean all parts in clean, OSHA approved solvent, and air blow-dry them only.

 WARNING	Because they are flammable, be extremely careful when using any solvents. Even a small explosion or fire could cause injury or death.
--	---

 WARNING	Wear eye protection and be sure to comply with OSHA or other maximum air pressure requirements.
--	---

 CAUTION	Never steam clean or high-pressure wash hydraulic steering components. Do not force or abuse closely fitted parts. Use care that bearing and sealing surfaces are not damaged by the assembly and disassembly procedures.
--	---

Keep each part separate to avoid nicks and burrs.

Disassembly

Tools Required

Hammer
Press
Ratchet
Retaining Ring Pliers
Screwdriver
Sockets: 1 1/4", 9/16", 7/16"

Vise

Materials Required

Marker, solvent-proof
Small Rod (1/8" dia. or less)

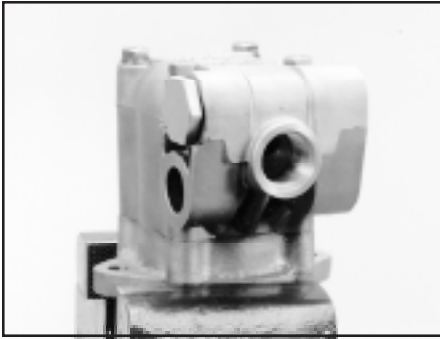

Position pump in vise

Vise

1. Place the pump in a vise, clamping firmly on the cover. Do not deform the cover with excessive clamping force.

CAUTION Clamp on the cover only. Clamping on the housing may cause damage requiring pump replacement.

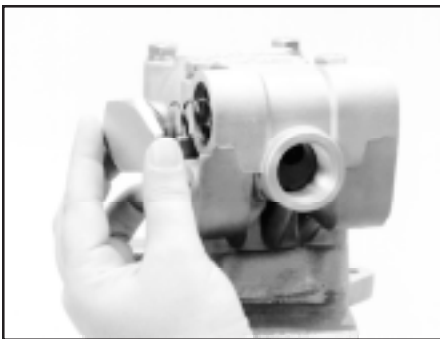

Remove plug

1 1/4" Socket

2. Prepare for fluid drainage and remove the hydraulic plug (9) and o-ring (8). Discard the o-ring.

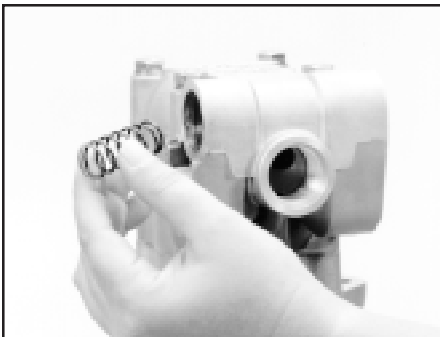

Remove spring

3. Remove the spring (7), if it didn't come out with the plug.

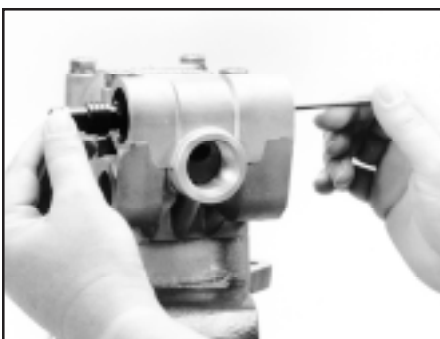

Remove valve spool assembly

Small rod, 1/8" dia. or less

4. Remove the valve spool assembly (6) by hand, or by pushing with a small rod through the orifice (3) on the opposite end of the spool cavity. Don't push on the small screen located in the relief valve seat assembly (6E).

Note whether or not the valve spool assembly slides freely in the housing.

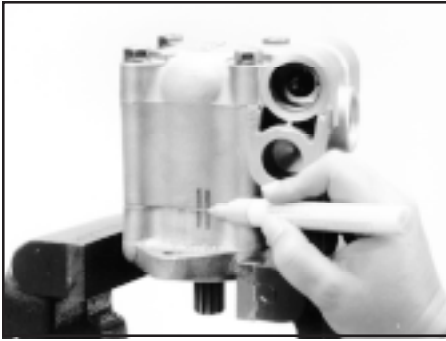

Mark cover orientation

Marker, solvent proof

5. Make a mark across the housing (1) and cover (21) to make reassembly easier.

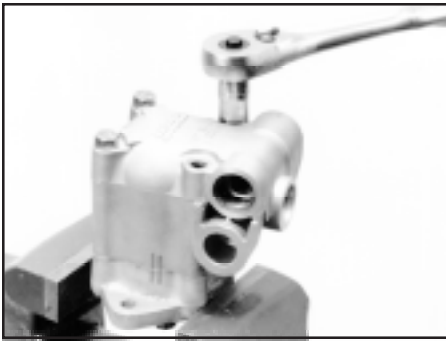

Remove bolts

9/16" Socket

6. Prepare for fluid drainage and remove 4 bolts (4), and washers (5).



Remove housing

7. Separate the housing (1) from the cover (21) using a twisting motion.

CAUTION

Wear eye protection. The spring (10) will make the housing jump, and may fly out. Make sure you hold the housing tightly when removing.



Remove spring

8. Remove the spring (10).



Mark internal components

Marker, solvent proof

9. Make a line across remaining internal components to make reassembly easier.



Remove top plate, O-ring and backup ring

10. Hold the cam ring (14) in place, and remove the top plate (13).

Remove the o-ring (11) and Teflon backup ring (12) from the top plate. Discard the o-ring and Teflon backup ring.



Remove cam ring, locate dots

11. Hold the bottom plate (17) in place, and remove the cam ring (14). Note and record whether the dots near the locating pin holes on the cam ring are up or down.

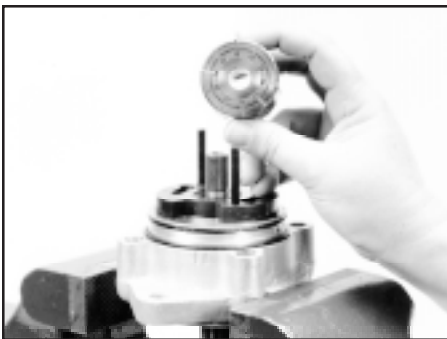

Remove rotor and vanes

12. Look for wear on the outside (radiused) edge of the vanes. Note and record the direction of the wear for reinstallation. Remove the rotor (16) and vanes (15) carefully, being prepared for the vanes to slip from their slots in the rotor.



Remove locating pins

13. Remove the locating pins (18). Make marks on the outside of the cover (not on the sealing surface) to remind you from which holes the locating pins were removed.



Remove bottom plate

14. Remove the bottom plate (17).

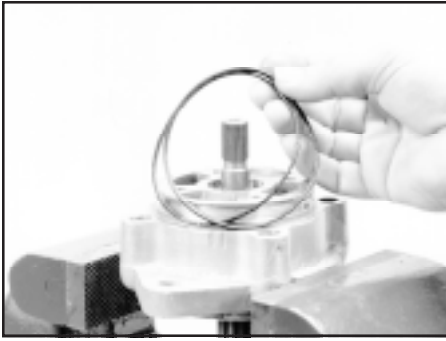

Remove o-rings

15. Remove o-rings (19 & 20) from the cover, and discard the o-rings.

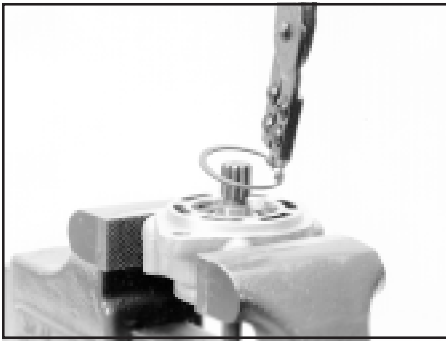

Remove retaining ring

Retaining ring pliers

16. Turn the cover over and remove the large retaining ring (27). Don't deform the cover with excessive clamping force.

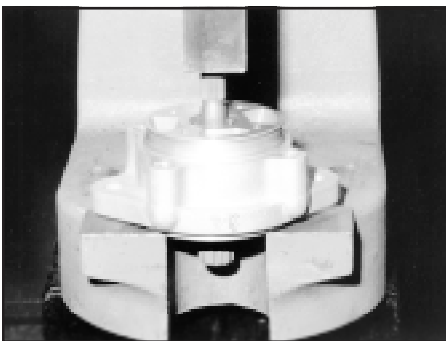

Press out shaft & bearing

Press

17. Press out the input shaft (28) and ball bearing assembly (26).



Inspect input shaft/ ball bearing subassembly

18. Check the input shaft (28) for damaged splines and unusual wear around the shaft seal area. Check retaining rings (25) for damage. The ball bearing (26) should exhibit free-rolling operation. If replacement is required, go to **Input Shaft Replacement** section on page 31. Otherwise, proceed to step 19.

NOTE

TRW recommends the ball bearing not be removed from the input shaft unless replacement of shaft is necessary.



Remove spacer

19. Remove the spacer (24) from the cover.



Remove shaft seal

Hammer
Screwdriver

20. Remove the shaft seal (23) being careful not to damage the bore. Discard the shaft seal.

CAUTION Damage to the bore could cause leakage.



Inspect needle bearing

21. Make sure all needles roll freely in the needle bearing (22). If removal is necessary, go to **Needle Bearing Removal** section on page 32. Otherwise, proceed to step 22.

NOTE TRW recommends the needle bearing not be removed from the cover.



Remove relief valve seat assembly

22. Remove the relief valve seat assembly (6E) from the valve spool assembly (6) by placing the spool in a collet if necessary.

CAUTION Take care not to deform the spool nor make nicks or burrs on the surface. If the spool is damaged, both the spool and housing must be replaced.



Remove spool assembly components

7/16" Socket

23. Remove the shims (6D) (make sure to count them), poppet (6C) and spring (6B) from the spool (6A).

Inspection

Make sure all sealing surfaces and seal cavities are free from nicks and corrosion. Any nicked or corroded surface requires part replacement to ensure proper sealing.

Wash all parts in clean, OSHA approved solvent. Air blow them dry only.

⚠ WARNING Because they are flammable, be extremely careful when using any solvents. Even a small explosion or fire could cause injury or death.

⚠ WARNING Wear eye protection and be sure to comply with OSHA or other maximum air pressure requirements.

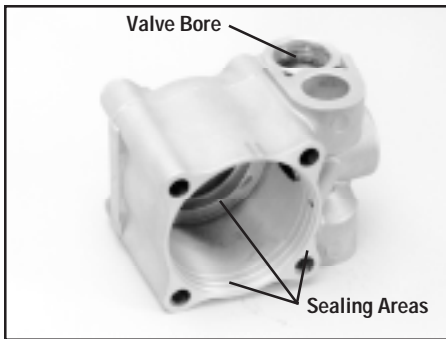

Inspect housing

1. Inspect the housing (1) for cracks, stripped threads, damaged valve bore and damaged sealing areas.

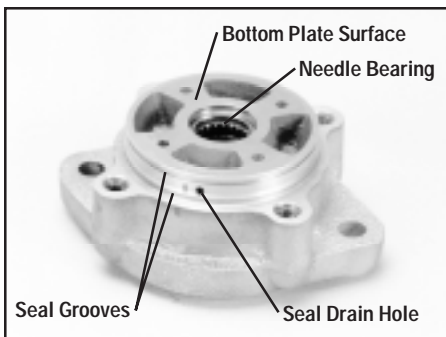

Inspect cover

2. Inspect the cover (21) for nicks in o-ring seal grooves. Make sure the seal drain hole is open, and the seal bore is free of nicks and other damage.

Make sure the surface on which the bottom plate rests is flat and free of nicks and other damage.

Make sure all needles roll freely in the needle bearing (22).



Inspect top plate

3. Inspect the top plate (13) for seal area nicks, and abnormal wear or erosion. A polished pattern from the rotor and vanes is normal, grooves you can feel with your fingernail are not normal.



Inspect cam ring

4. Look for obvious damage on the inside of the cam ring (14) like abnormal wear, erosion or surface imperfections.



Inspect rotor and vanes

5. Inspect the rotor (16) and vanes (15) for abnormal wear or damage. There will be normal polish marks on both the top and bottom. The vanes need to be free to slide both up and down and in and out. If vanes are removed for inspection, make sure to reinstall them with the rounded edge out.



Inspect bottom plate

6. Check the bottom plate (17) for abnormal wear patterns.

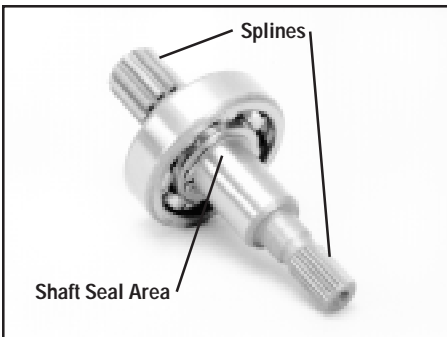

Inspect input shaft/ Ball Bearing

7. Check the input shaft (28) for damaged splines and unusual wear or grooves around the shaft seal area. Grooves you can detect with your fingernail necessitate replacement of the input shaft.

The ball bearing (26) should exhibit free-rolling operation.



Inspect spool components

8. Inspect spool components as follows: Check all components for damage. Check the relief valve seat assembly (6E) for wear or chipping. Back flush with air and solvent if necessary. Check the spool for nicks or burrs.

Assembly Preparation

Wash all parts in clean, OSHA approved solvent. Air blow-dry them only.

⚠ WARNING Because they are flammable, be extremely careful when using any solvents. Even a small explosion or fire could cause injury or death.

⚠ WARNING Wear eye protection and be sure to comply with OSHA or other maximum air pressure requirements.

Assembly

Tools Required

Lbf•ft Torque wrench
Press
Ratchet
Retaining ring pliers
Sockets: 1 1/4", 9/16", 7/8" deep well
Vise

Materials Required

Grease (petroleum base chassis lube)

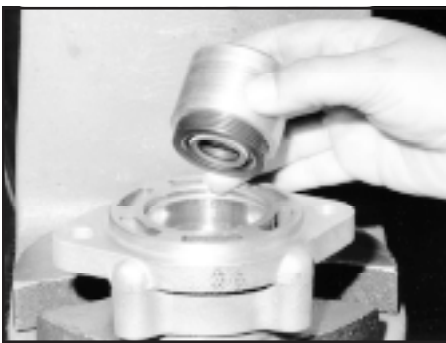

Press in shaft seal

Press
Suitable size
tool or socket

1. Grease the outside diameter of the shaft seal (23) with the special grease provided, and press it into the cover, with the lettered side facing toward the needle bearing. The installed seal should be flush with or just below the sealing surface on the cover.

⚠ CAUTION Make sure the press is clean and free of debris so as not to damage the face of the cover on which the bottom plate rests. If damage occurs to the cover, the pump will not function properly.

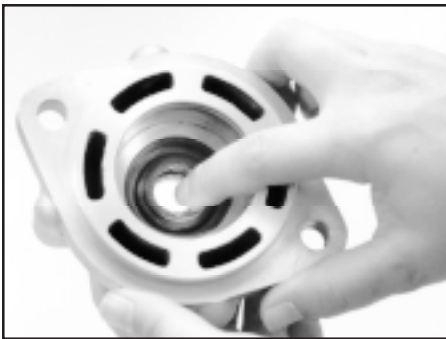

Grease shaft seal

Grease

2. Grease the inside diameter of the shaft seal (23) with the special grease provided.



Install spacer

3. Install the spacer (24). Make sure it lays flat. There is no up or down for the spacer.

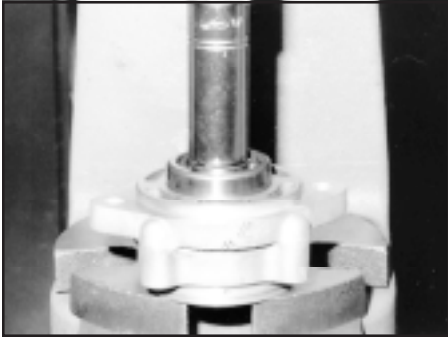

Insert input shaft into cover

Press
7/8" Deep well
socket

4. Insert the input shaft (28), small splined end first, into the cover. Don't allow the splines to contact the shaft seal (23). Engage the shaft into the seal by hand until the ball bearing contacts the cover.

Use a 7/8" socket or other appropriate tool to press the shaft and bearing into the cover until it bottoms.

CAUTION If splines contact the shaft seal, the seal can be damaged. Take great care to not allow contact. Tape splines if desired.



Install large retaining ring

Retaining ring
pliers

5. Place the cover in a vice and install the large retaining ring (27) with the sheared edge out. Don't deform the cover with excessive clamping force.

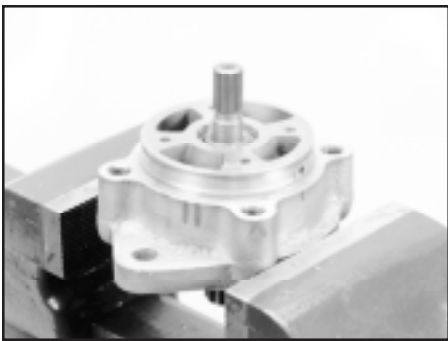

Reverse the cover assembly

6. Reverse the cover assembly in the vice. Don't deform the cover with excessive clamping force.

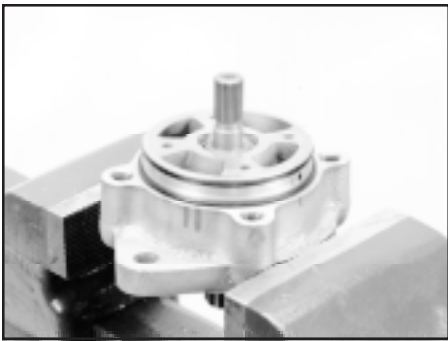

Install o-rings

7. Install a new large o-ring (20), onto the cover without rolling it. Make sure it is properly seated on the cover sealing surface.

Install a new small o-ring (19) onto the cover without rolling it. Make sure it is properly seated in its groove.

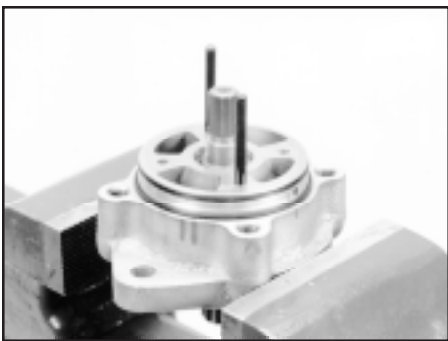

Install locating pins

8. Install the locating pins (18) according to the marks you made on the outside of the housing during disassembly.

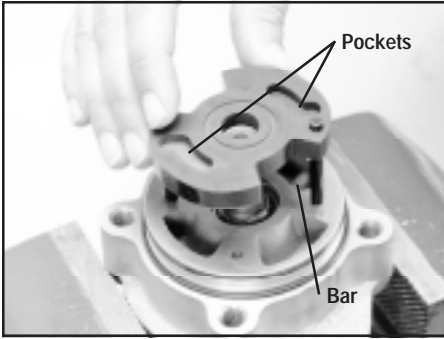

Install bottom plate

9. Notice there is a bar in one of the four cutouts in the cover. This bar should be covered by the bottom plate when it is installed. Install the bottom plate (17) with the pockets facing up. The bottom plate is installed correctly if the:

- bar is covered,
- pockets face up,
- outermost edges are fairly symmetrical with the mounting surface,
- marks made for internal components align.

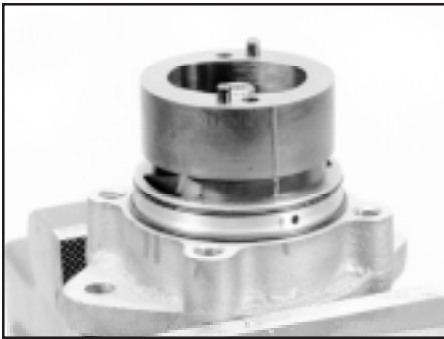

Install cam ring

10. Install the cam ring (14) with the dots facing up or down as noted during disassembly. Locating pins go into the smaller holes, the cam ring will only fit properly one way.

The installed cam ring should be fairly flush with the bottom plate at the large outside diameter. Alignment marks made during disassembly should be aligned.

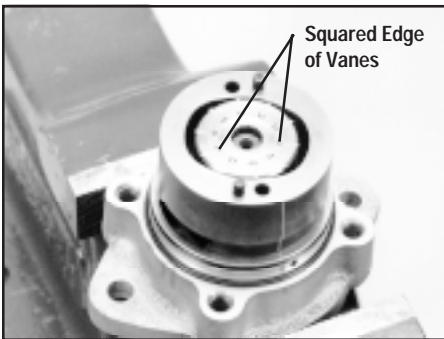

Install rotor and vanes

11. Install the rotor (16) and vanes (15) in the same orientation as removed and noted. If vanes are separate from the rotor, install the rotor first, then install the vanes.

Make sure all vanes are installed with the squared edge toward the center of the rotor.

CAUTION If vanes are installed with the square edge out, they could cause premature wear to components.

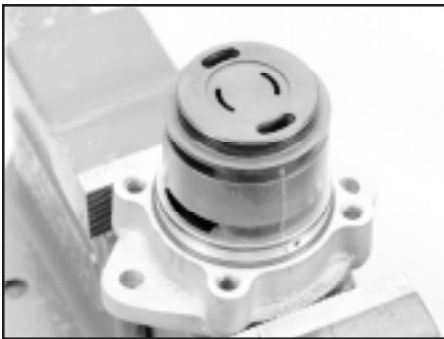

Install top plate

12. Install the top plate (13) with the pin holes down. The locating pins (18) must be engaged in the pin holes, not the pockets.

The top plate should be fairly flush with the cam after installation. Alignment marks made during disassembly should align.

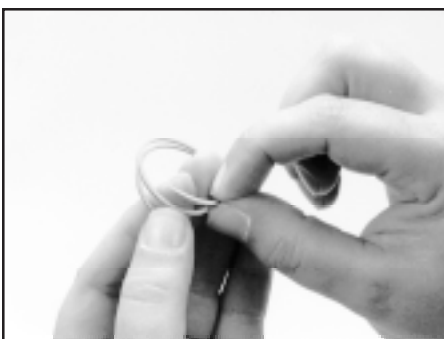

Prepare backup ring

13. To make the new Teflon backup ring (12) hold more tightly to the top plate, wrap the backup ring, without twisting, loosely around two fingers, and then allow it to unwrap.

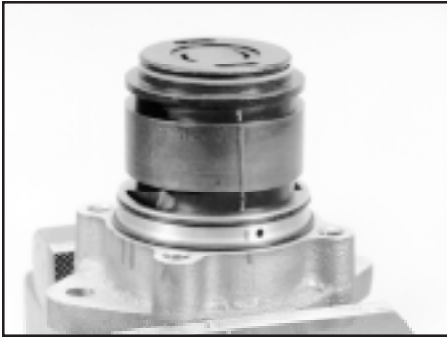

Install backup ring

14. Install the backup ring (12) on the top plate. Seat it at the bottom of the groove.



Install o-ring

15. Install a new o-ring (11) on the top plate without allowing it to roll. Seat it at the top of the groove.



Grease o-ring and back-up ring

16. Grease the o-ring (11) and back-up ring (12).



Grease housing sealing areas

17. Grease the sealing areas of the housing (1).

 CAUTION	The housing may have sharp edges. Be careful not to cut your finger when applying grease.
--	---



Position spring

18. Place the spring (10) on the top plate (13).

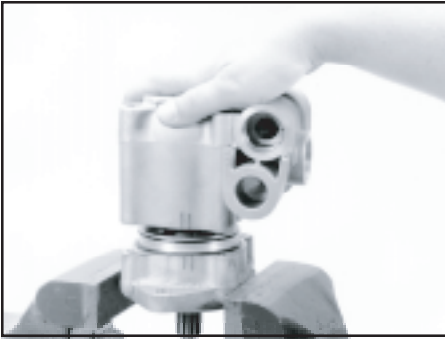

Install housing

- Place the housing (1) over the cover assembly. Make sure the orientation is correct by matching the original markings made on the housing and cover during disassembly.



Install bolts and washers

9/16" Socket
Torque wrench

- Install the bolts (4) and washers (5). Thread all four bolts into the cover evenly, and **torque alternately to 25 lbf•ft. (35 N•M)**

CAUTION Failure to thread the bolts into the cover evenly could result in damage to the seals, top plate or housing.

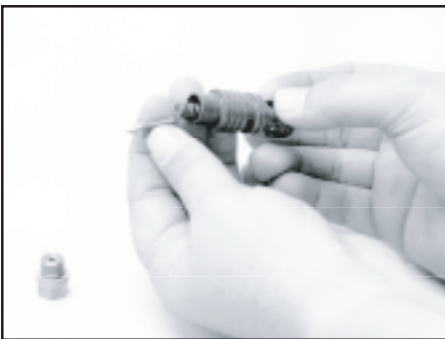

Assembly valve spool assembly

- Assemble valve spool components: Insert spring (6B), and poppet (6C) (blunt end first) into the spool (6A). Install shims (6D) onto the relief valve seat assembly (6E).

Make sure to install the same number of shims as were removed.

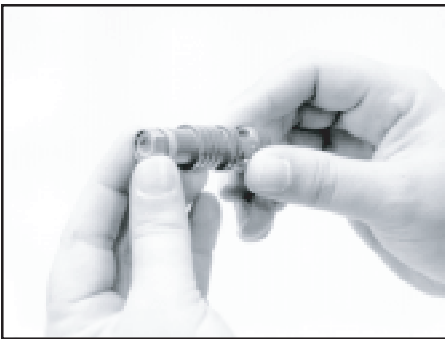

Install relief valve seat assembly

7/16" Socket
Torque wrench

- Screw the relief valve seat assembly into the spool and **torque to 11 lbf•ft. (15 N•M)**. Placing the spool in a collet will facilitate torquing.

CAUTION Take care not to deform the spool nor make nicks or burrs on the surface. If the spool is damaged, both the spool and housing must be replaced.

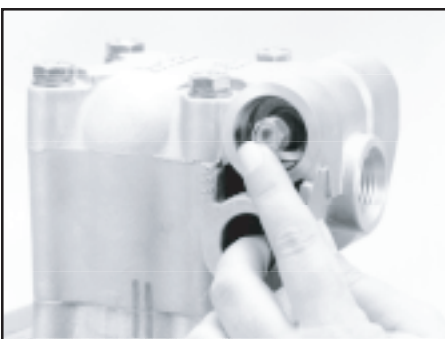

Install valve spool assembly

- Insert the valve spool assembly (6), screen end last, into the housing. Make sure the spool slides freely in the housing.

WARNING Do not install the valve spool backwards; doing so disables the pressure relief function of the pump. Serious personal injury may occur if hydraulic components burst due to over-pressurizing the power steering system.



Install spring

24. Install the spring (7).



Install o-ring

25. Install a new o-ring (8) onto the plug (9).



Install plug & o-ring

26. Lightly grease the o-ring (8) and plug (9) threads. Install into housing, and **torque to 20 lbf·ft. (27 N·M)**

1 1/4" Socket
Torque wrench

Install woodruff key if removed

27. Install the woodruff key into the new input shaft, if removed during input shaft replacement.

Input Shaft Replacement

Tools Required

Press
Retaining ring pliers
7/8" Deep well socket



Remove retaining ring

Retaining ring pliers

1. Remove the retaining ring (25), nearest the engine drive end, from the shaft.

Remove woodruff key, if equipped.

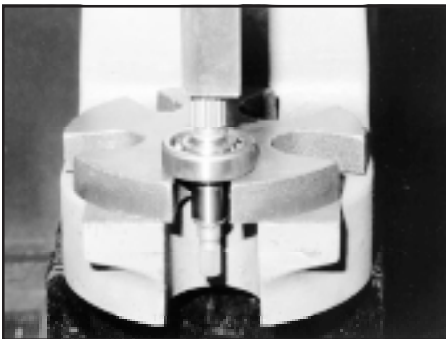

Press shaft from bearing

Press

2. Press the input shaft (28) from the ball bearing (26) applying pressure to the engine drive end of the input shaft.

Remove the second retaining ring (25) and replace it in the same groove in the new input shaft, sheared edge out.

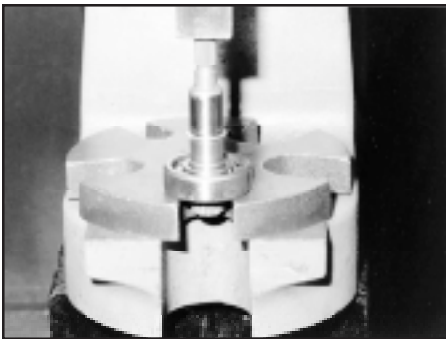

Press ball bearing onto input shaft

7/8" Deep well socket
Press

3. Press the new input shaft (28) into the ball bearing (26) from the small splined end, until it bottoms on the retaining ring.

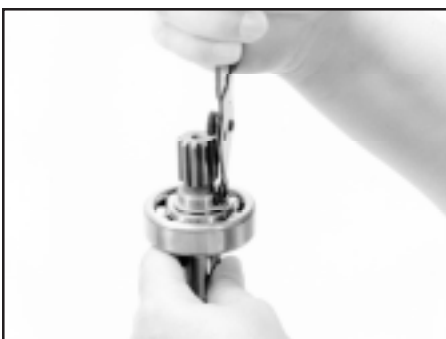

Install retaining ring

Retaining ring pliers

4. Install the retaining ring (25) onto the input shaft with the sheared edge away from the bearing. Make sure it is properly seated in its groove.

Needle Bearing Removal

Tools Required

Press
11/16" and 7/8" Deep well sockets

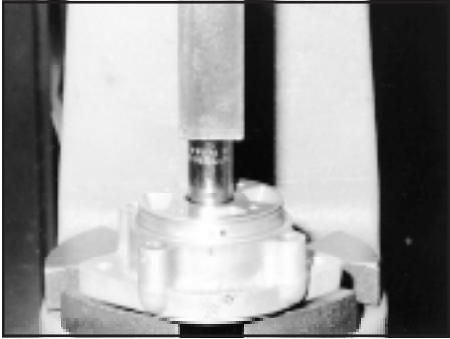

Press out needle bearing

Press
11/16" Socket
or other
suitable tool

1. Place the cover in a press with the flange side down. Press the needle bearing (22) out of the cover.



Inspect needle bearing

2. Make sure all needles roll freely in the needle bearing (22).

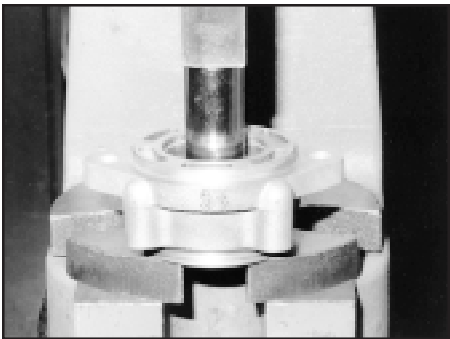

Press in needle bearing

Press
7/8" Deep well
socket, or
other suitable
tool

3. Put the cover in a clean press with the flange side up. Press the needle bearing (22) into the cover, lettered side toward the pressing tool, until flush with the inside surface.

⚠ CAUTION

Make sure the press is clean and free of debris so as not to damage the face of the cover on which the bottom plate rests. If damage occurs the cover will have to be replaced for the pump to function properly.

Section 4 **Reinstallation**

Reinstallation	34
Filling and Air Bleeding the System	35
Maintenance Tips	36

Reinstallation

1. Reinstall any fittings removed prior to disassembly.
2. Reinstall the gear on the input shaft if one was removed prior to disassembly.
3. Reinstall the retaining nut, if one was removed prior to disassembly, and torque to manufacturer's specification.
4. Position the new gasket or o-ring (whichever was removed) which will seal the pump face to the mounting surface.
5. Engage the input shaft.
6. Tighten the mounting bolts to manufacturer's specifications.
7. Unplug and reconnect the input and output lines.
8. Fill the reservoir.
9. Start the vehicle to purge the system.
10. Turn off the vehicle and check the fluid level in the reservoir. Add fluid as necessary.
11. Bleed the system if necessary using instructions on the following page.

Filling & Air Bleeding the TRW System (TAS Gear)

Tools Required	Materials Required
$\frac{5}{16}$ " Socket Lbf•in. Torque wrench	Hydraulic fluid

CAUTION Make sure poppets are set correctly before beginning this procedure.

Run engine for 10 seconds, turn off and fill reservoir

1. Fill the reservoir nearly full. Do not steer. Start and run the engine for 10 seconds, then shut it off. Check and refill the reservoir. Repeat at least three times, checking the reservoir each time.

Hydraulic fluid

CAUTION Do not allow the fluid level to drop significantly or run out of the reservoir. This may induce air into the system.

Run engine for 2 minutes, turn off and fill reservoir

2. Start the engine and let it idle for 2 minutes. Do not steer. Shut off the engine and check the fluid level in the reservoir. Refill as required.

Hydraulic fluid

Steer vehicle

3. Start the engine again. Steer the vehicle from full left to full right several times. Add fluid, as necessary, to the full line on the dip stick.

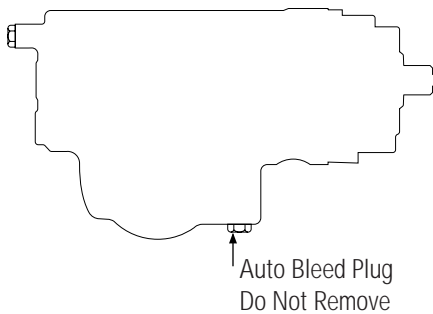

Automatic bleed systems should now be free from trapped air. **Manual bleed systems continue with step 4.**

Allow air to bleed out from bleed screw

4. With engine idling, steer from full left turn to full right turn several times. Stop steering, with the wheels pointed straight ahead, and loosen the manual bleed screw about one turn. Allow air and aerated fluid to "bleed out" until only clear fluid is seen. Close the bleed screw, refill the reservoir if required.

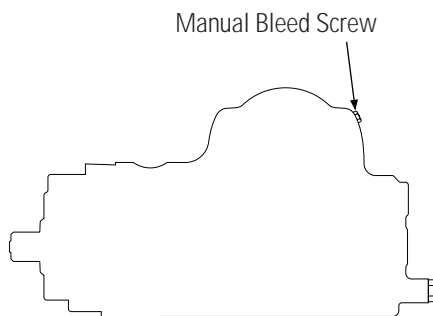

Lbf•in. Torque wrench
 $\frac{5}{16}$ " Socket

Repeat step 4 three to four times until all the air is discharged. Torque manual bleed screw to **30 lbf•in.**

CAUTION Do not turn steering wheel with bleed screw loosened.

Maintenance Tips

Never high-pressure wash or steam clean a power steering pump while off the vehicle. Doing so could force contaminants inside the pump and cause it to malfunction.

Always **clean off around the reservoir filler cap** before you remove it. Prevent dirt or other foreign matter from entering the hydraulic system.

Regularly check the fluid and the fluid level in the power steering reservoir.

Investigate and correct any external leaks, no matter how minor.

Encourage drivers to report any malfunctions or accidents which could have damaged steering components.

Replace reservoir filters according to requirements.

Do not attempt to weld any broken steering component. Replace the component with original equipment only.

If you feel the vehicle is developing excessively **high hydraulic fluid temperatures**, consult with your vehicle manufacturer for recommendations.

Do not cold-straighten, hot straighten, or bend any steering system component.

Section 5

Glossary

Glossary 39

Glossary

Abnormal Wear

Any wear other than normal "polish marks" made by the spinning motion of the rotor and vanes. Abnormal wear would include nicks, chips, cracks and grooves.

Burrs

Rough edges or ridges left on metal by cutting or drilling.

Corrosion

Gradual wearing away by rust or chemical action.

Cracks

breaks or splits in the surface.

Damaged Splines

Cracked, broken or chipped splines on the input shaft.

Displacement

Volume of output fluid transferred through the pump.

Drain Hole

Excess fluid from lubricating the seal is diverted internally in the pump housing back to the inlet of the pumping element via the drain holes located in the cover and housing.

Erosion

Gradual wearing away or deteriorating.

Full Turn

Axle contacts axle stop

Grooves

A long, narrow furrow cut in a surface.

Input Port

Opening in the pump through which fluid is received from the reservoir. (Suction port).

Manual Bleed Systems

Gears are mounted in such a way that an air pocket could form in one end of the steering gear. The bleed screw is positioned so trapped air can be forced out when loosened.

Nicks

Small cuts, indentations or chips on the edge or surface.

OSHA

Occupational Safety and Health Administration

Output Port

Opening in the pump through which fluid is forced to the steering gear. (Pressure port).

Relief Valve

Limits maximum supply pressure

Subassembly

An assembled unit that fits into a larger unit

Stripped Threads

Broken or damaged threads.

Surface Imperfections

Blemish on a machined surface.



TRW Automotive
Commercial Steering Systems
800 Heath Street
Lafayette, IN 47904
Tel 765.423.5377
Fax 765.429.1868
<http://www.trw.com/commercialsteering>