

Haier SERVICE MANUAL

LED TV



Model No. 48D3500

MSD3393

Chassis



WARNING

This service information is designed for experienced repair technicians only and is not designed for use by the general public. It does not contain warnings or cautions to advise non-technical individuals of potential dangers in attempting to service a product. Products powered by electricity should be serviced or repaired only by experienced professional technicians. Any attempt to service or repair the product or products dealt with in this service information by anyone else could result in serious injury or death.

Chapter 1: General Information

1-1. Table of Contents

1. General Information.....	1
1-1. Table of Contents	1
1-2. General Guidelines	3
1-3. Important Notice	3
1-4. How to Read this Service Manual	6
2. Specifications.....	6
3. Location of Controls and Components.....	8
3-1. Board Location	8
3-2. Main Board & AV Board	8
3-3. Power board	11
3-4. LCD Panel	13
4. Disassemble and Assemble.....	14
4-1 Remove the Pedestal	14
4-2 Remove the Back Cover	14
4-3 Remove the Adhesive Tape	14
4-4 Remove the Main Board	15
4-5 Remove the Speaker	15
4-6 Remove the Remote Control Board	16
4-6 Remove the Power board	16
5. Installation Instructions.....	17
5-1 External Equipment Connections	17
5-2 HDMI Connections	21
6. Operation Instructions.....	24
6-1 Front Panel Controls	24
6-2 Back Panel Controls	23
6-3 Universal Remote Control	25
7. Electrical Parts.....	26
7-1. Circuit Diagram	26
7-2. Wiring Connection Diagram	31

8. Measurements and Adjustments.....	32
8-1. How to enter into the factory model	35
8-2. How to update software	36
8-3. How to enter into the Hotel Model	37
9. Trouble-shooting.....	38
9-1. Simple Check	38
9-2. Main Board Failure Check	39
9-3. Panel Failure	46

1-2. General Guidelines

When servicing, observe the original lead dress. If a short circuit is found, replace all parts which have been overheated or damaged by the short circuit.

After servicing, see to it that all the protective devices such as insulation barriers, insulation papers shields are properly installed.

After servicing, make the following leakage current checks to prevent the customer from being exposed to shock hazards.

- 1) Leakage Current Cold Check
- 2) Leakage Current Hot Check
- 3) Prevention of Electro Static Discharge (ESD) to Electrostatically Sensitive

1-3. Important Notice

1-3-1. Follow the regulations and warnings

Most important thing is to list up the potential hazard or risk for the service personnel to open the units and disassemble the units. For example, we need to describe properly how to avoid the possibility to get electrical shock from the live power supply or charged electrical parts (even the power is off).

This symbol indicates that high voltage is present inside. It is dangerous to make any kind of contact with any inside part of this product.

This symbol indicates that there are important operating and maintenance instructions in the literature accompanying the appliance.

1-3-2. Be careful to the electrical shock

To prevent damage which might result in electric shock or fire, do not expose this TV set to rain or excessive moisture. This TV must not be exposed to dripping or splashing water, and objects filled with liquid, such as vases, must not be placed on top of or above the TV.

1-3-3. Electro static discharge (ESD)

Some semiconductor (solid state) devices can be damaged easily by static electricity. Such components commonly are called Electrostatically Sensitive (ES) Devices. The following techniques should be used to help reduce the incidence of component damage caused by electrostatic discharge (ESD).

1-3-4. About lead free solder (PbF)

This product is manufactured using lead-free solder as a part of a movement within the consumer products industry at large to be environmentally responsible. Lead-free solder must be used in the servicing and repairing of this product.

1-3-5. Use the genuing parts (specified parts)

Special parts which have purposes of fire retardant (resistors), high-quality sound (capacitors), low noise (resistors), etc. are used.

When replacing any of components, be sure to use only manufacture's specified parts shown in the parts list.

Safety Component

- Components identified by  mark have special characteristics important for safety.

1-3-6 Safety Check after Repairment

Confirm that the screws, parts and wiring which were removed in order to service are put in the original positions, or whether there are the positions which are deteriorated around the serviced places serviced or not. Check the insulation between the antenna terminal or external metal and the AC cord plug blades. And be sure the safety of that.

General Servicing Precautions

1. Always unplug the receiver AC power cord from the AC power source before;
 - a. Removing or reinstalling any component, circuit board module or any other receiver assembly.
 - b. Disconnecting or reconnecting any receiver electrical plug or other electrical connection.
 - c. Connecting a test substitute in parallel with an electrolytic capacitor in the receiver.

CAUTION: A wrong part substitution or incorrect polarity installation of electrolytic capacitors may result in an explosion hazard.

2. Test high voltage only by measuring it with an appropriate high voltage meter or other voltage measuring device (DVM, FETVOM, etc) equipped with a suitable high voltage probe.

Do not test high voltage by "drawing an arc".

3. Do not spray chemicals on or near this receiver or any of its assemblies.
4. Unless specified otherwise in this service manual, clean electrical contacts only by applying the following mixture to the contacts with a pipe cleaner, cotton-tipped stick or comparable non-abrasive applicator; 10% (by volume) Acetone and 90% (by volume) isopropyl alcohol (90%-99% strength).

CAUTION: This is a flammable mixture.

Unless specified otherwise in this service manual, lubrication of contacts is not required. Capacitors may result in an explosion hazard.

5. Do not defeat any plug/socket B+ voltage interlocks with which receivers covered by this service manual might be equipped.
6. Do not apply AC power to this instrument and/or any of its electrical assemblies unless all solid-state device heat sinks are correctly installed.
7. Always connect the test receiver ground lead to the receiver chassis ground before connecting the test receiver positive lead.

Always remove the test receiver ground lead last. Capacitors may result in an explosion hazard.

8. Use with this receiver only the test fixtures specified in this service manual.

CAUTION: Do not connect the test fixture ground strap to any heat sink in this receiver.

9. Remove the antenna terminal on TV and turn on the TV.

10. Insulation resistance between the cord plug terminals and the external exposure metal should be more than Mohm by using the 500V insulation resistance meter.

11. If the insulation resistance is less than M ohm, the inspection repair should be required. If you have not the 500V insulation resistance meter, use a Tester. External exposure metal: Antenna terminal Headphone jack

Electrostatically Sensitive (ES) Devices

Some semiconductor (solid-state) devices can be damaged easily by static electricity. Such components commonly are called Electrostatically Sensitive (ES) Devices. Examples of typical ES devices are integrated circuits and some field-effect transistors and semiconductor "chip" components. The following techniques should be used to help reduce the incidence of component damage caused by static by static electricity.

1. Immediately before handling any semiconductor component or semiconductor-equipped assembly, drain off any electrostatic charge on your body by touching a known earth ground. Alternatively, obtain and wear a commercially available discharging wrist strap device, which should be removed to prevent potential shock reasons prior to applying power to the unit under test.
2. After removing an electrical assembly equipped with ES devices, place the assembly on a conductive surface such as aluminum foil, to prevent electrostatic charge buildup or exposure of the assembly.
3. Use only a grounded-tip soldering iron to solder or unsolder ES devices.
4. Use only an anti-static type solder removal device. Some solder removal devices not classified as "anti-static" can generate electrical charges sufficient to damage ES devices.
5. Do not use freon-propelled chemicals. These can generate electrical charges sufficient to damage ES devices.
6. Do not remove a replacement ES device from its protective package until immediately before you are ready to install it.
(Most replacement ES devices are packaged with leads electrically shorted together by conductive foam, aluminum foil or comparable conductive material).
7. Immediately before removing the protective material from the leads of a replacement ES device, touch the protective material to the chassis or circuit assembly into which the device will be installed.

CAUTION: Be sure no power is applied to the chassis or circuit, and observe all other safety precautions.

8. Minimize bodily motions when handling unpackaged replacement ES devices. (Otherwise harmless motion such as the brushing together of your clothes fabric or the lifting of your foot from a carpeted floor can generate static electricity sufficient to damage an ES device.)

1-3-7. Ordering Spare Parts

Please include the following informations when you order parts. (Particularly the Version letter)

1. Model number, Serial number and Software Version

The model number and Serial number can be found on the back of each product and the Software Version can be found at the Spare Parts List.

2. Spare Part No. and Description

You can find them in the Spare Parts List

1-3-8. Photo used in this manual

The illustration and photos used in this Manual may not base on the final design of products, which may differ from your products in some way.

1-4. How to Read this Service Manual

Using Icons:

Icons are used to attract the attention of the reader to specific information. The meaning of each icon is described in the table below:

Note:

A “note” provides information that is not indispensable, but may nevertheless be valuable to the reader, such as tips and tricks.

Caution:

A “caution” is used when there is danger that the reader, through incorrect manipulation, may damage equipment, loose data, get an unexpected result or has to restart(part of) a procedure.

Warning:

A “warning” is used when there is danger of personal injury.

Reference:

A “reference” guides the reader to other places in this binder or in this manual, where he/ she will find additional information on a specific topic.

2. Specifications

Model	48D3500
Screen Size	48 inch
Aspect Ratio	16:9
Resolution	1920*1080
Response Time (ms)	8.0 (GRAY TO GRAY)
Angel of View	176o
Color Display	16.7M
No. of Preset Channels	Cable :1-135 Air: 2-69 (ATV&DTV)
OSD Language	English
Color System	NTSC
Audio System	DK, BG, I, M, L, L'
Audio Output Power (Built-in) (W)	10W×2
Audio Output Power (outer) (W)	No
Total Power Input (W)	72W
Voltage Range (V)	AC 100-240V
Power Frequency (Hz)	50~60Hz
Net Weight (KG)	12.8
Gross Weight (KG)	15.8
Net Dimension (MM)	1073*78*645mm
Packaged Dimension (MM)	1073*280*703mm

3. Location of Controls and Components

3-1 Board Location

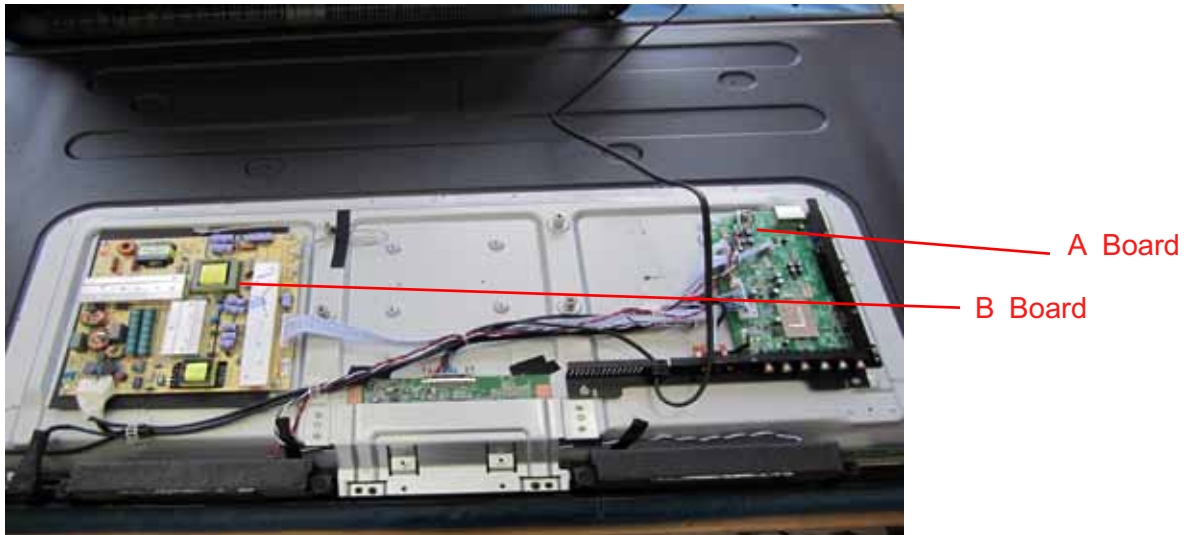

No.	Description
A Board	Mainboard
B Board	Power Supply

3-2 Main Board



3-2-1 Function Description:

Main Board

Process signal which incept from exterior equipment then translate into signal that panel can display.

3-2-2 Connector definition

Main board connector

Power connectors (J16)

		J16	
		Pin number	Signal name
		1	GND
		2	BL-ADJUST
	BRIGHT	3	BL-ON/OFF
		4	+5V
		5	POWER ON/OFF
		6	+5VSTB
		7	+5V
		8	+5V
		9	GND
		10	GND
		11	GND
		12	+12V
		13	+12V

Notes:

J16-Pin 3: Backlight on/off:

The system can turn on or turn off the backlight of TFT LCD Panel through the power supply unit path.

J16-Pin 6: System power on / standby

System board will use this pin to control system power.

J16-Pin 2: Control the luminance of backlight

The system can generate the PWN signal to control the strength of TFT LCD Panel's backlight through this connector

Keypad and remote connector (J2)

Pin number	Signal name	Description
1	GND	
2	KEY1	
3	KEY0	
4	NC	
5	5V	POWER FOR REMOTE
6	GND	GND
7	IR	REMOTE CONTROL
8	STANDBY	
9	LED_G	LAMP GREEN
10	LED_R	LAMP RED

Speaker connector (J17)

Pin number	Signal name	Description
1	RSPK+	RSPK+
2	RSPK-	RSPK-
3	LSPK-	LSPK-
4	LSPK+	LSPK+

3-3. Power Board



3-3-1 Function Description:

Supply power for Main board, Panel.

3-3-2 Connector definition

		CON4	
		Pin number	Signal name
		1	NC
		2	GND
		3	GND
		4	+5V
		5	POWER ON/OFF
		6	+5VSTB
		7	+5V
		8	+5V
		9	GND
		10	GND
		11	GND
		12	+12V
		13	+12V

3-4. LED Panel



LSC480HN02-G

3-4-1.Connector de finition

Connector : FI-RE51S-HF (JAE/UJU)

Pin	Symbol	Description	Pin	Symbol	Description
1	NC	NOTE1	26	NC	NOTE1
2	NC	NOTE1	27	NC	NOTE1
3	NC	NOTE1	28	Rx2[A]N	Even LVDS Signal -
4	NC	NOTE1	29	Rx2[A]P	Even LVDS Signal +
5	NC	NOTE1	30	Rx2[B]N	Even LVDS Signal -
6	NC	NOTE1	31	Rx2[B]P	Even LVDS Signal +
7	NC	NOTE1	32	Rx2[C]N	Even LVDS Signal -
8	NC	NOTE1	33	Rx2[C]P	Even LVDS Signal +
9	NC	NOTE1	34	GND	Ground
10	NC	NOTE1	35	Rx2CLK-	LVDS Clock -
11	GND	Ground	36	Rx2CLK+	LVDS Clock +
12	Rx1[A]N	Odd LVDS Signal -	37	GND	Ground
13	Rx1[A]P	Odd LVDS Signal +	38	Rx2[D]N	Even LVDS Signal -
14	Rx1[B]N	Odd LVDS Signal -	39	Rx2[D]P	Even LVDS Signal +
15	Rx1[B]P	Odd LVDS Signal +	40	Rx2[E]N (Note 2)	Even LVDS Signal -
16	Rx1[C]N	Odd LVDS Signal -	41	Rx2[E]P (Note 2)	Even LVDS Signal +
17	Rx1[C]P	Odd LVDS Signal +	42	NC	NOTE1
18	GND	Ground	43	NC	NOTE1
19	Rx1CLK-	LVDS Clock -	44	GND	Ground
20	Rx1CLK+	LVDS Clock +	45	GND	Ground
21	GND	Ground	46	GND	Ground
22	Rx1[D]N	Odd LVDS Signal -	47	NC	NOTE1
23	Rx1[D]P	Odd LVDS Signal +	48	12V	DC power supply
24	Rx1[E]N (Note 2)	Odd LVDS Signal -	49	12V	DC power supply
25	Rx1[E]P (Note 2)	Odd LVDS Signal +	50	12V	DC power supply
			51	12V	DC power supply

4. Disassemble and assemble

4-1 Remove the Pedestal



- Lay down the unit so that rear cover faces upward
- Remove the three screw from the rear cover indicated with ○
- Then remove the pedestal

4-2 Remove the Back Cover

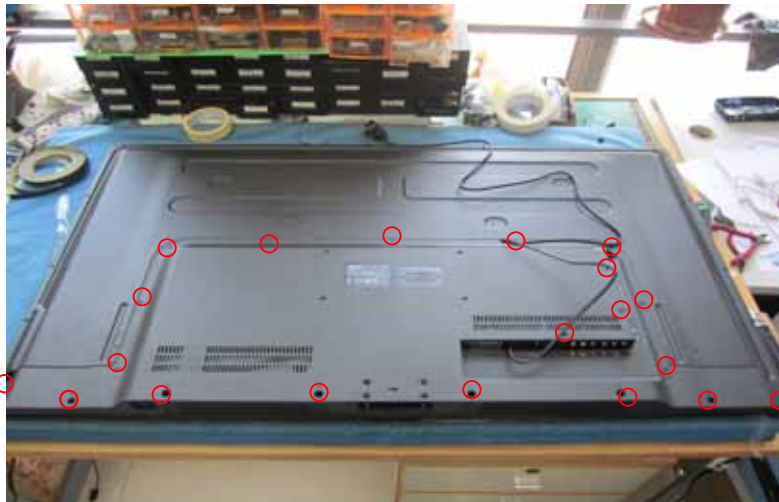

- Remove the these screw indicated on figure above by ○
- Then remove the back cover from the unit.

4-3. Remove the adhesive tape



Remove the adhesive tape indicated on the figure above

4-4 Remove the Main board

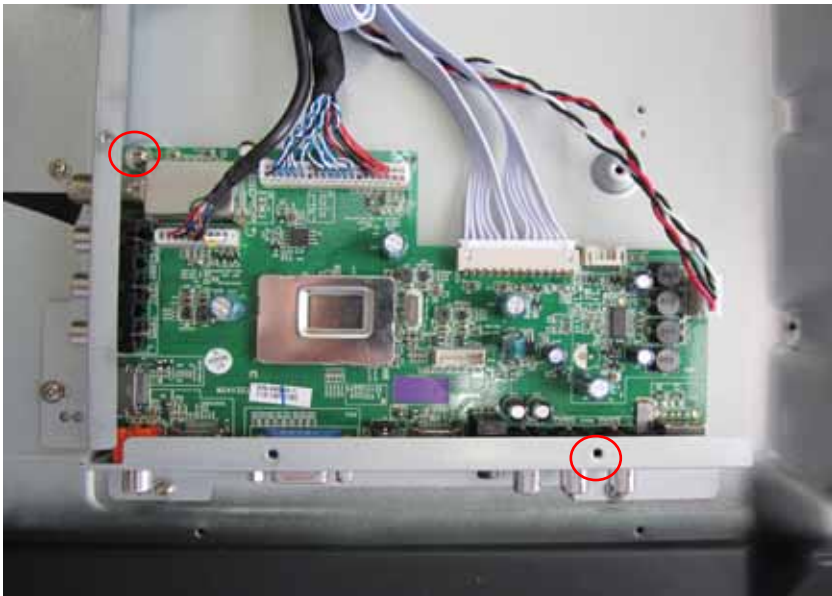

- Disconnected the coupler
J1 J2 J16 J17

- Remove the Main board

4-5 Remove the speaker



Take out the speaker

4-6 Remove the remote control



take out the remote controlboard

4-7 Remove the Power Supply



5. Installation Instructions

5-1 External Equipment Connections

Accessories



Remote Control



Battery

User GUIDE

Antenna Connection

Connect one end of a coaxial cable (not included) to the ANT IN jack on the back of your TV/DVD combo, then connect the other end of the cable into the antenna or cable TV wall outlet.

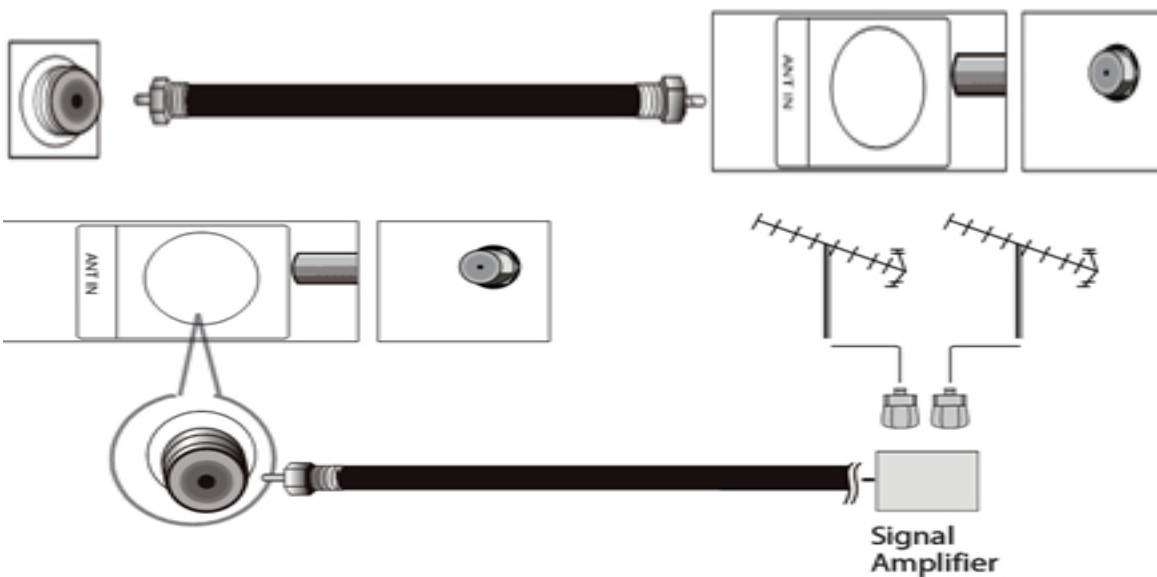

To improve picture quality from an antenna in a poor signal area, install a signal amplifier.

If you need to split the antenna signal to connect two TVs, install a two-way splitter.

ANTENNA

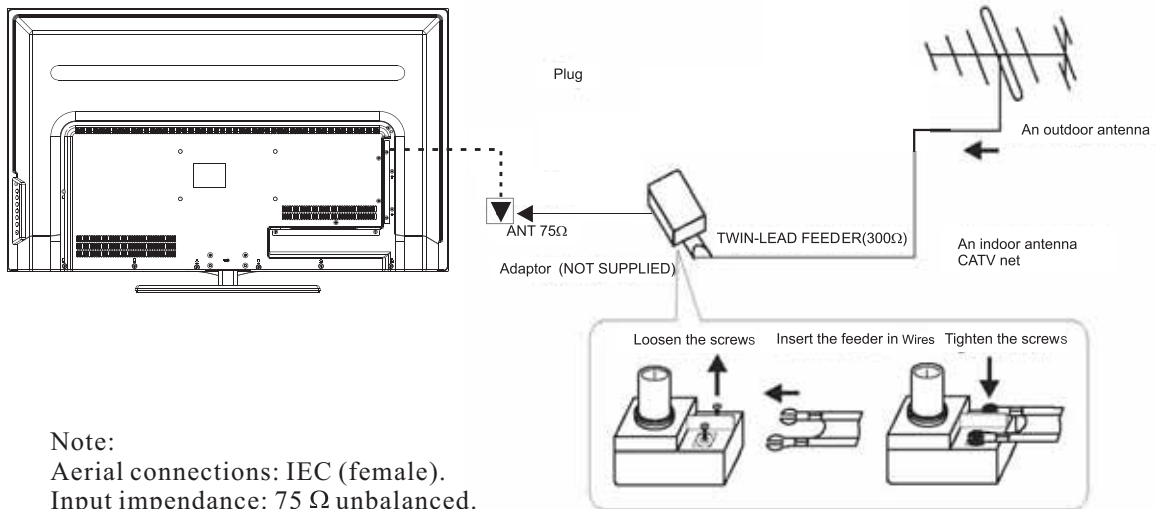

Note:
Aerial connections: IEC (female).
Input impedance: 75 Ω unbalanced.

PC

STEPS:

- Be sure both the TV and computer are powered off.
1. Connect a VGA and audio cable.
 2. Connect the power cord.
 3. Turn on the TV, switch to PC mode.
 4. Turn on the PC.

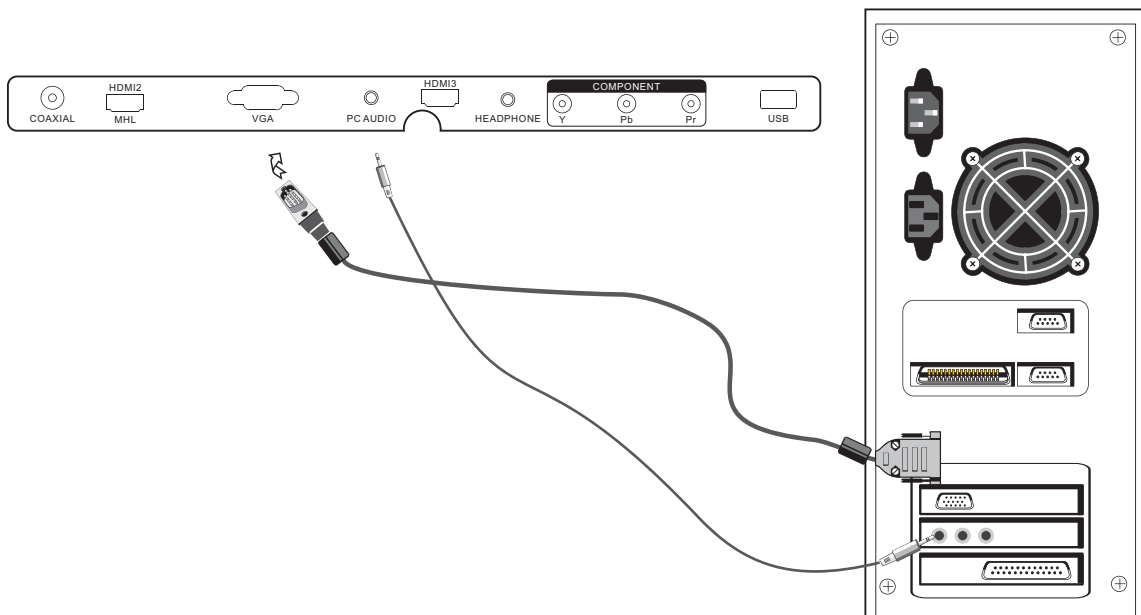

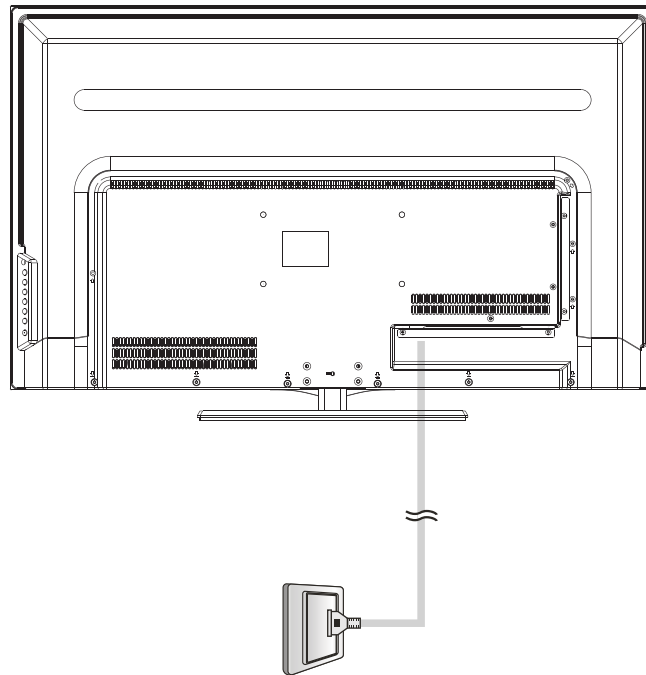

PC

PRESET MODE

	RESOLUTION	V.Freq.(Hz)	H.Freq.(KHz)
1	640*480	60	31.47
2	800*600	60	37.88
3	1024*768	60	48.36
4	1280*1024	60	63.98
5	1366*768	60	47.71
6	1920*1080	60	67.50

AV EQUIPMENT

There are three HDMI ports located on the back of your TV. You can connect a Blu-ray player, DVD player, or other video equipment through these ports.

The HDMI2 port is MHL enabled. You can connect MHL devices, such as the compatible mobile phones and tablets.

NOTE: a USB to HDMI cable is required to connect a mobile phone or tablet to the TV. Please check the documentation of your device.

There is one component (Y, Pb, Pr) and one composite (AV) video input located on the back of your TV. You can connect a VCR, cable box, or other video equipment to these jacks.

Please see the diagram below. You may also need to refer to the owner's manual of the device that you are trying to connect.

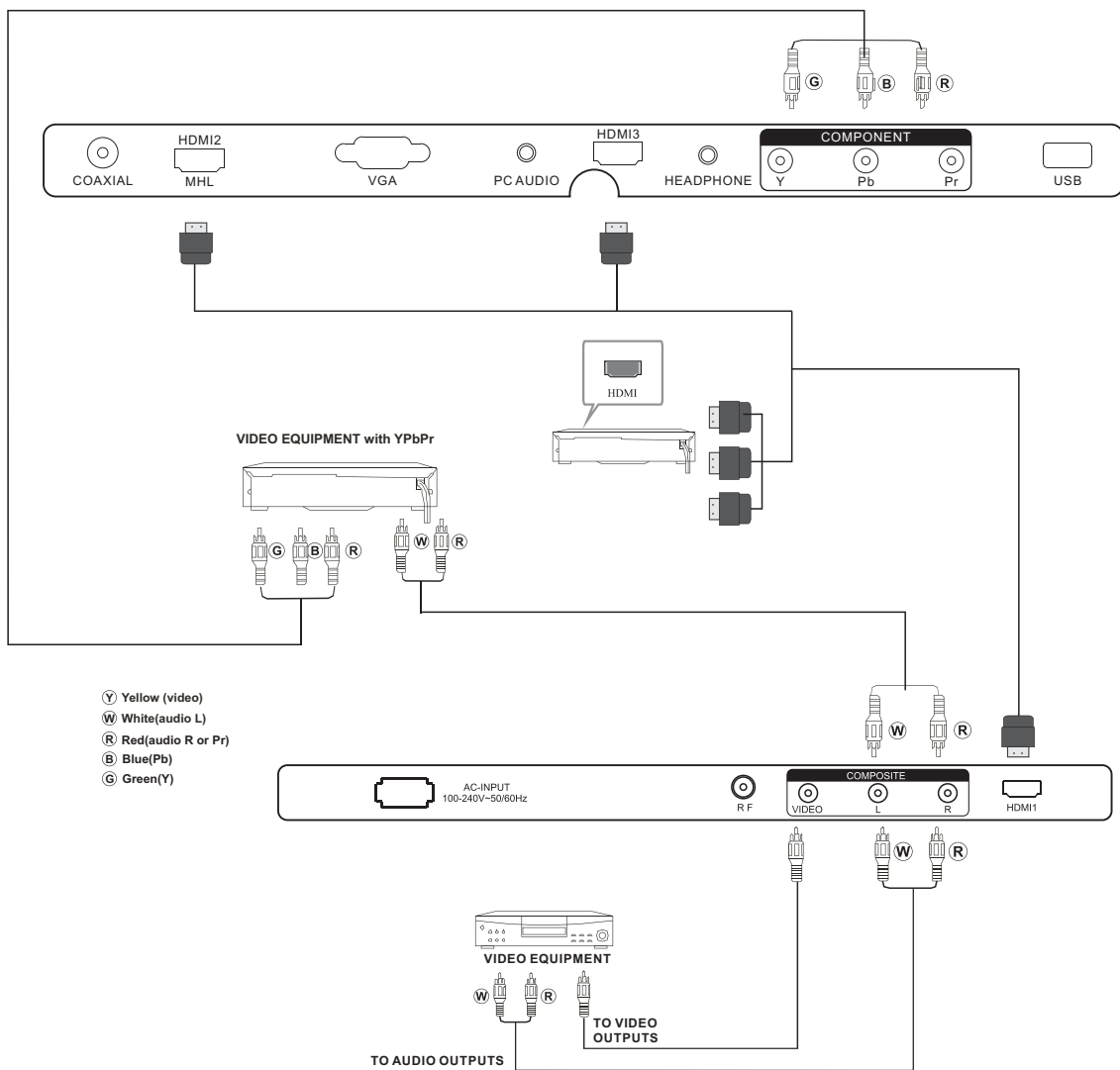

The television's inputs can be connected to the following types of equipment: VCR, multi disc player, DVD, camcorder, video game or stereo system, etc.....

YPbPr can support these video formats:480i,576i,480p,576p,720p,1080i, 1080p.

5-2 HDMI Connections

When the source device(DVD player or Set Top Box) supports HDM

How To Connect

1. Connect the source device to HDMI port of this TV with an HDMI cable(not supplied with this product).
2. No separated audio connection is necessary.

How To Use

If the source device supports Auto HDMI function, the output resolution of the source device will be automatically set to 1280x720p.

If the source device does not support Auto HDMI, you need to set the output resolution appropriately.

To get the best picture quality, adjust the output resolution of the source device to 1280x720p.

Select HDMI input source in input source option of Select Main source menu.

When the source device(DVD player or Set Top Box) supports DVI

How To Connect

1. Connect the source device to HDMI port of this TV with a HDMI-to-DVI cable(not supplied with this product).
2. A separated audio connection is necessary.
3. If the source device has an analog audio output connector, connect the source device audio output to DVI Audio In port located on the PC port.

How To Use

If the source device supports Auto DVI function, the output resolution of the source device will be automatically set to 1280x720p.



If the source device does not support Auto DVI, you need to set the output resolution appropriately.

To get the best picture quality, adjust the output resolution of the source device to 1280x720p.

Press the INPUT button to select HDMI input source in input source option of Select Main source menu.

Installation

Cable sample

	HDMI Cable (not supplied with the product)
	HDMI to DVI Cable (not supplied with the product)
	Analog Audio Cable (Stereo to RCA type) (not supplied with the product)

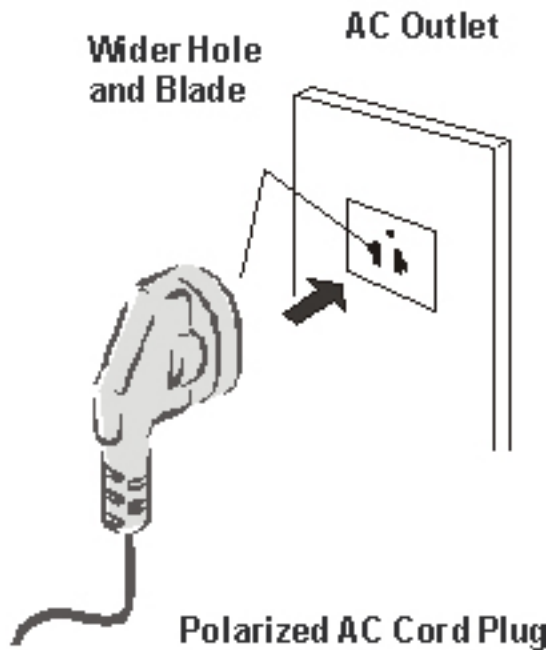

Power source

TO USE AC POWER SOURCE

Use the AC polarized line cord provided for operation on AC.
Insert the AC cord plug into a standard polarized AC outlet.

NOTES:

- Never connect the AC line cord plug to other than the specified voltage.
Use the attached power cord only.
- If the polarized AC cord does not fit into a non-polarized AC outlet, do not attempt to file or cut the blade. It is the user's responsibility to have an electrician replace the obsolete outlet.
- If you cause a static discharge when touching the unit and the unit fails to function, simply unplug the unit from the AC outlet and plug it back in. The unit should return to normal operation.

6. Operation Instructions

Basal information

Front panel

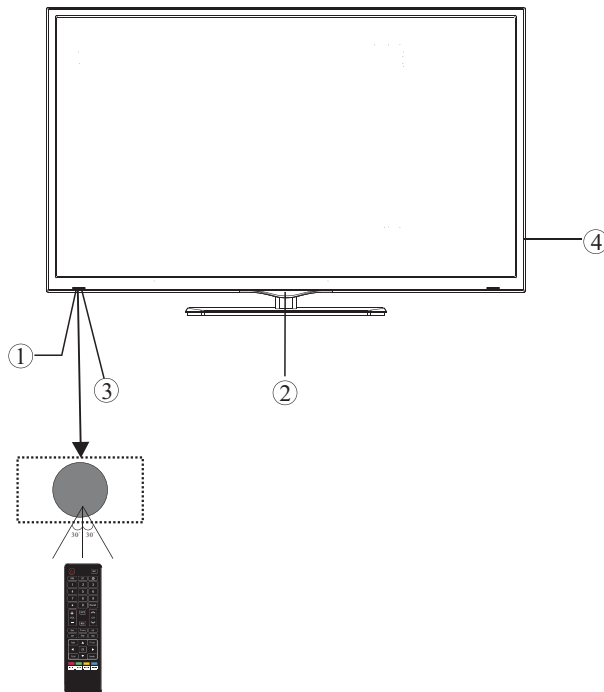

- 1: Remote control sensor.
 2: Indicator LED: **WHITE** ○ POWER ON.
 3: Indicator LED: **RED** ● STANDBY.
 4: Panel keys

Side panel

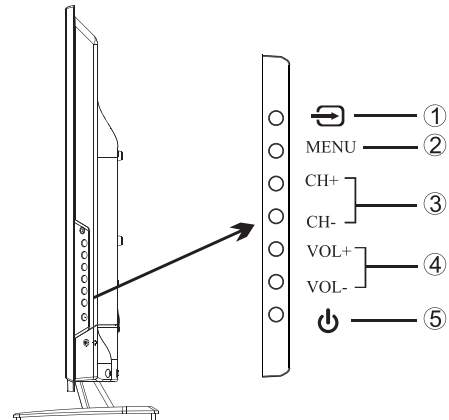

1. : Display the input source menu.
 2. **MENU**: Display main MENU.
 3. **CH+/CH-**: In TV mode, press "CH+" or "CH-" to change the channel up and down. In MENU mode, press "CH+" or "CH-" to select items; In standby mode, press "CH+" or "CH-" to turn on the TV.
 4. **VOL+/VOL-**: Adjust sound level. In MENU mode, press "VOL+" or "VOL-" to adjust the item that you selected.
 5. : Press this button to turn the unit ON from STANDBY mode. Press it again to turn the set back to STANDBY.

REAR Connections



All the terminals are (from left to right):
 POWER SOCKET, RF, VIDEO, AUDIO INPUT, HDMI1.

Note: AV and component (YPbPr) share the R and L audio inputs.

SIDE Connections



All the terminals are (from left to right):
 COAXIAL (audio output), MHL/HDMI2, VGA, PC AUDIO, HDMI3, HEADPHONE,
 YPbPr(COMPONENT)INPUT, USB.

Note: When HDMI has an input signal coming from a DVI source then the audio input signal must be connected to the PC audio input.

6-3 Setting Up Your Remote Control

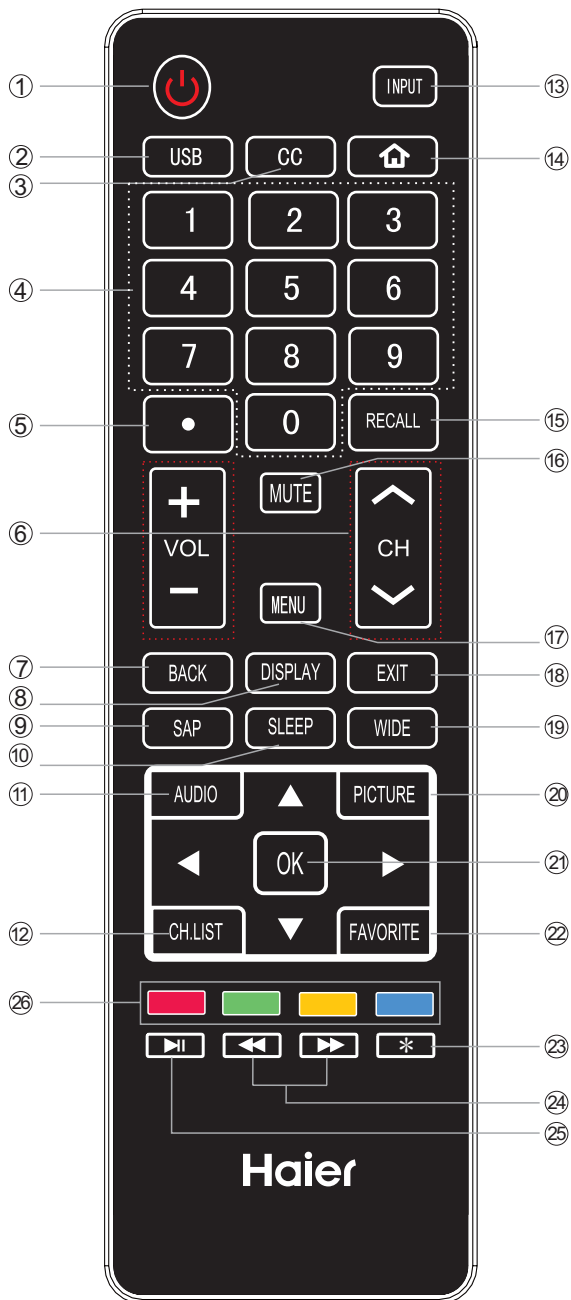

1. Press to turn on and off the TV.
2. USB: Press to launch the USB multimedia mode.
3. Select a closed caption option.
4. Press to input a channel.
5. Press to select the digital sub-channels. For example, to enter "54-3", press "54", "●", and then "3".
6. Press CH[^] or CH^v to go to the next or previous channel in the channel list. Press VOL+ or VOL- to increase or decrease the volume.
7. Return to the **previous** menu.
8. Press to display the TV status information.
9. Select MONO, STEREO, SAP in NTSC (analog TV) system.
10. Press to **cycle through** the sleep timer options.
11. Press to cycle through the different sound settings.
12. Open the channel list in TV mode.
13. Show the input source menu.
14. Switch to **the HDMI2/MHL input**.
15. Press to go to the last viewed channel.
16. Switches the TV sound on or off.
17. Press to open the on-screen **display (OSD)** menu.
18. Exit **the on-screen display**.
19. Press to change the aspect ratio.
20. Press to cycle through the available picture modes.
21. Press to confirm selections in an on-screen menu or to open a submenu.
22. Open the favorite channel list in TV mode.
23. **Reserved.**
24. **Reverse/Fast forward: Use these buttons to control music/photo playback.**
25. **PLAY/PAUSE: Press to play/pause music or photo slideshow in USB mode.**
26. **Reserved.**

7. Electrical parts

7-1. Circuit Diagram

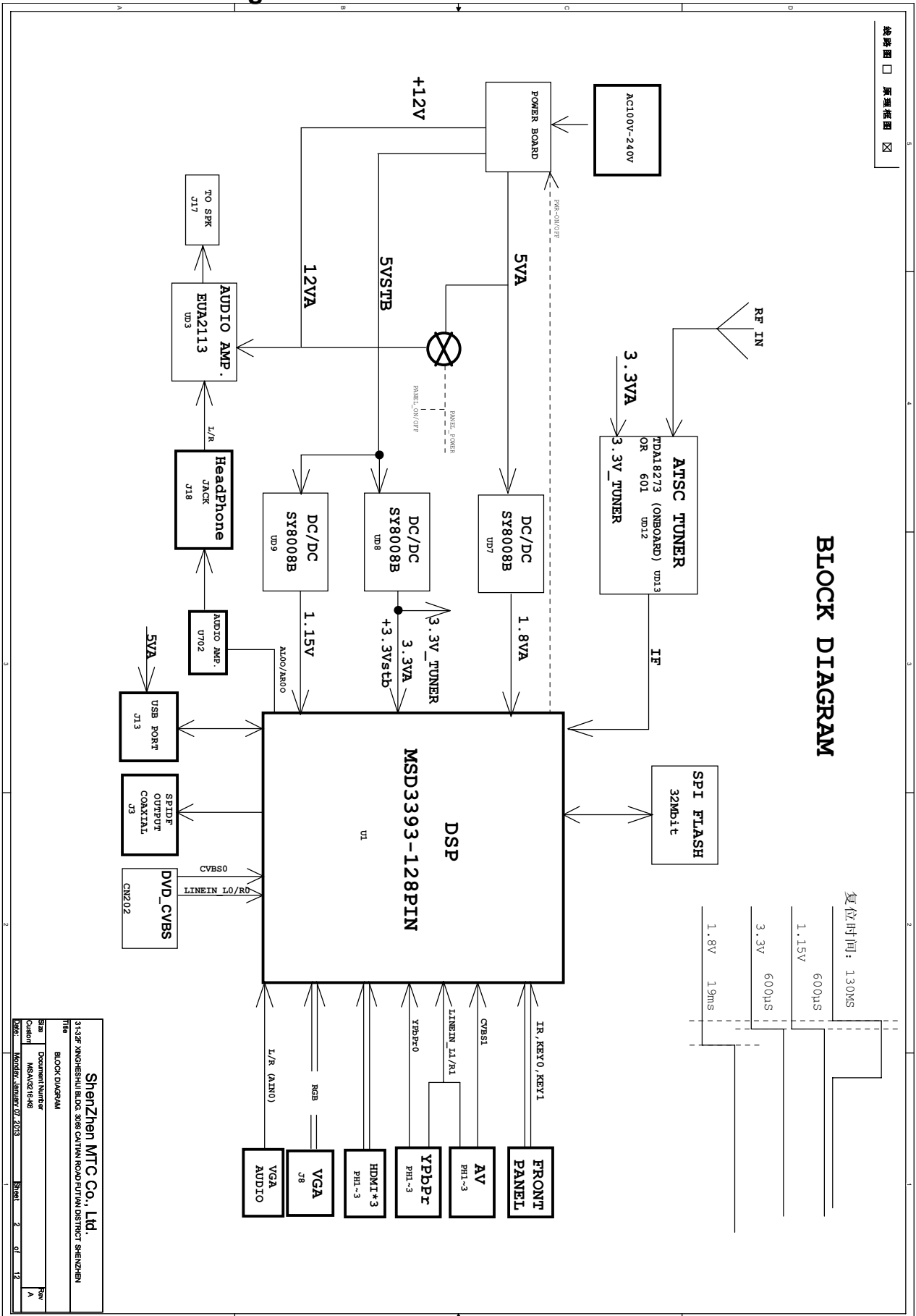

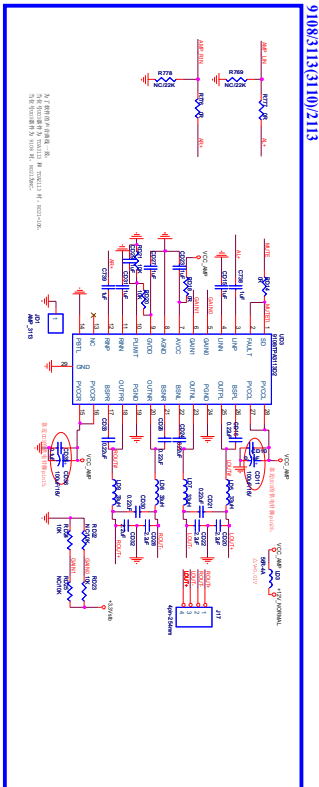
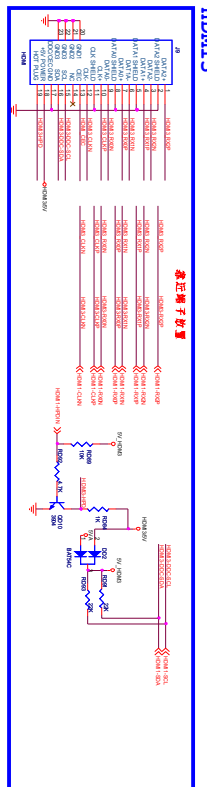
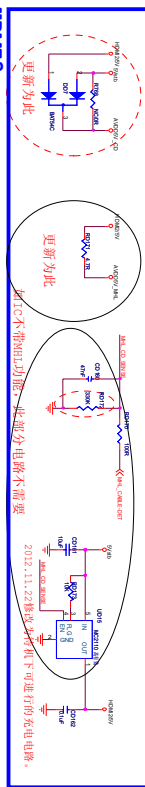
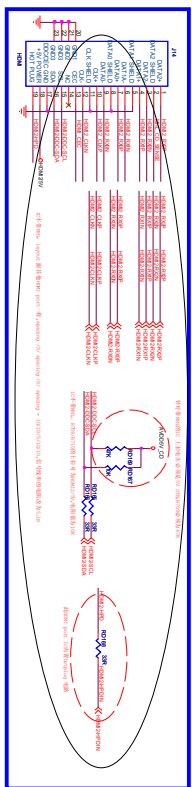
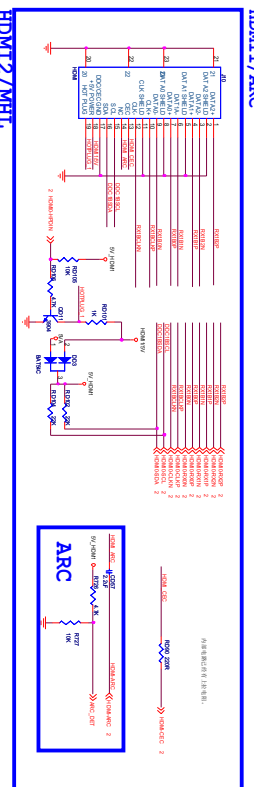
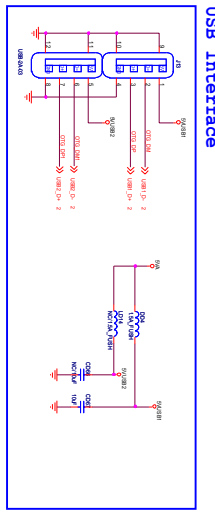
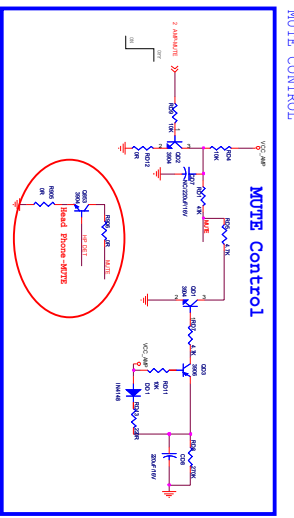
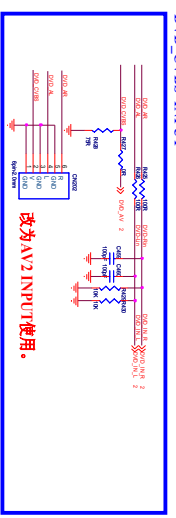
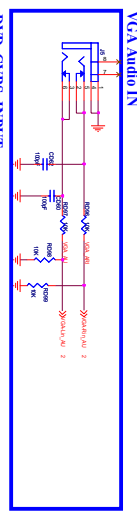
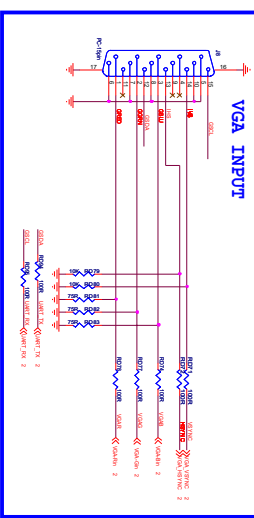
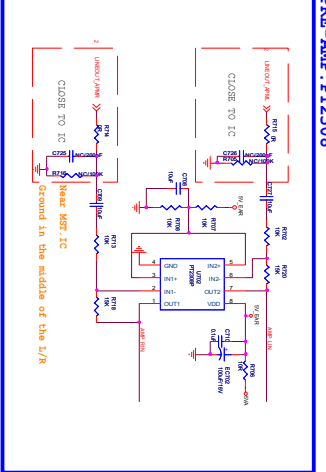
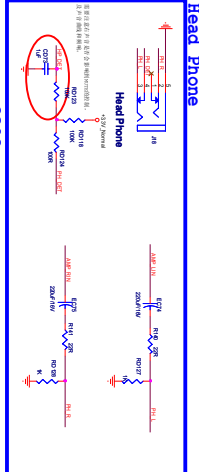
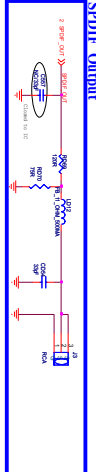
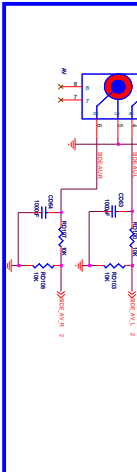
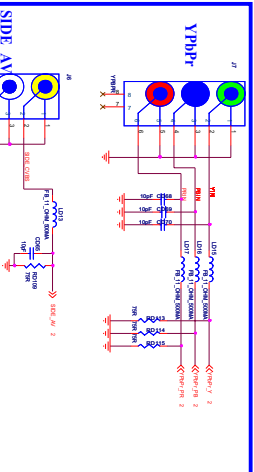

MSD3393
YIPPI VOAM & AV N

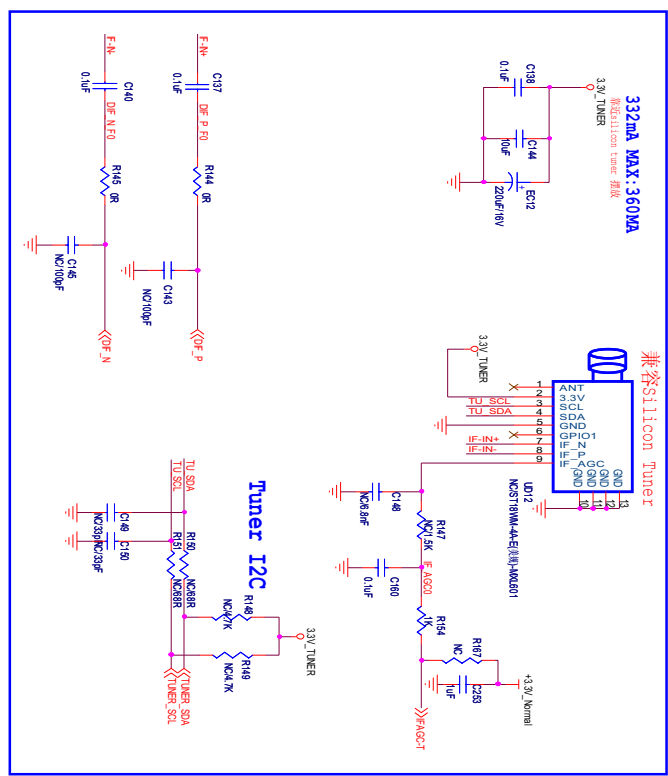
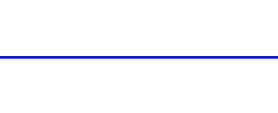
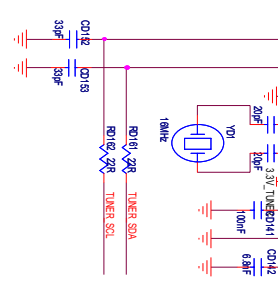
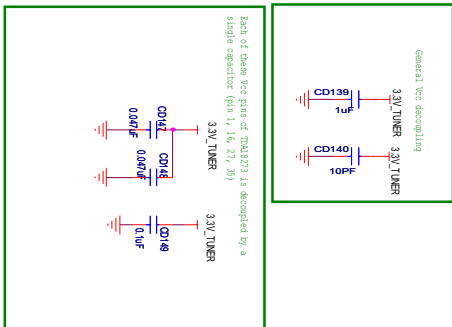
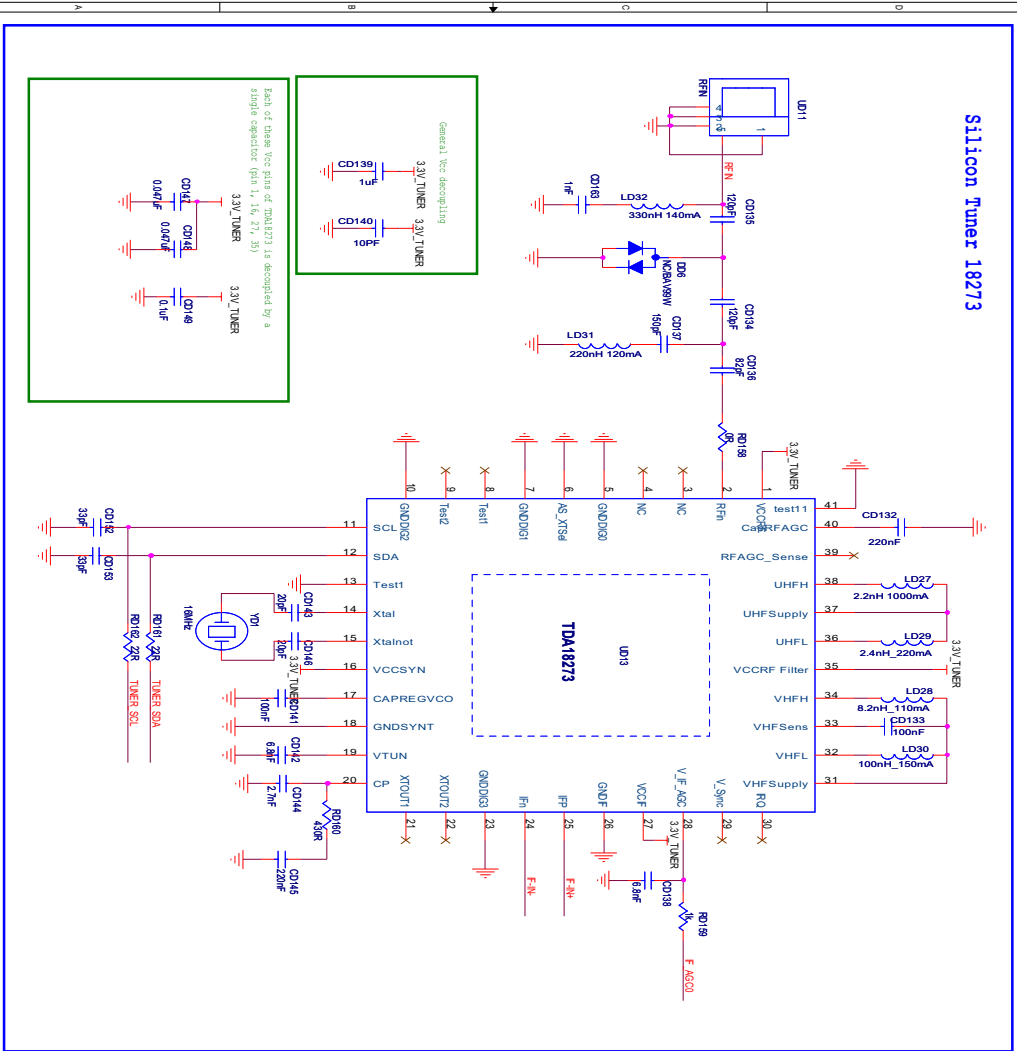

TR	MSD3393	Rev	1.0
Site	Document Number		
Customer	TUNER		
Date:	Thursday, January 17, 2013	Sheet	7 of 8

7-2 .Wiring Connection Diagram

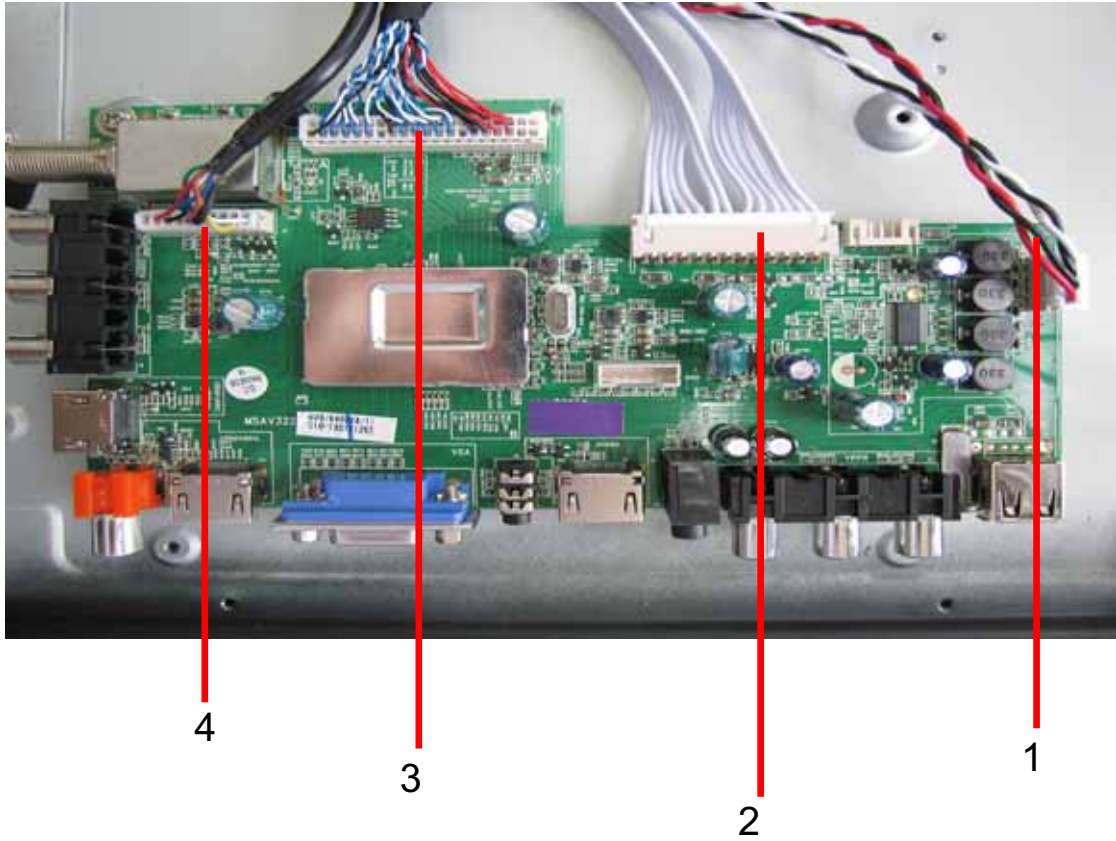

NO.	Name
1	Connection Wire(For Speaker)
2	Connection Wire(Power For Mainboard)
3	LVDS Wire
4	Connection Wire(For Remote and Keyboard)

8. Measurements and Adjustments

4. LOCK MENU

In this menu, you can change the password and adjust the vchip settings.

Enter the password, to enter the lock menu. The factory default password is 0000.

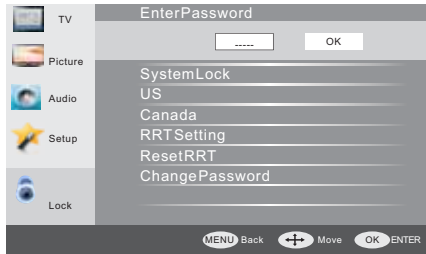

4.1 Change Password

- 1) Enter old password: Input the old password.
- 2) Enter new password: Input the new password.
- 3) Confirm password: Input the new password again.

4.2 System Lock

When the System Lock switch is ON, the options listed below can be adjusted.

4.3 US

Press **OK** to display the following screen.

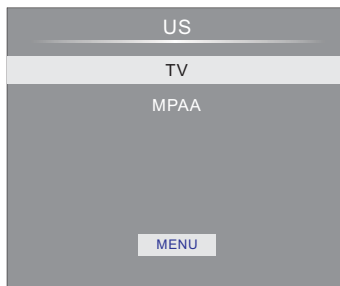

- 1) TV: Press **OK** display the following screen.

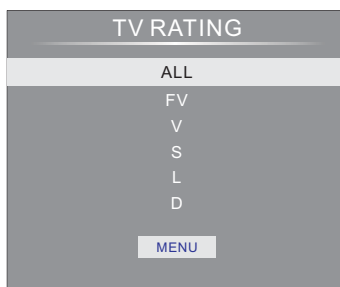

And use the **OK** key to lock/unlock Parental Controls .

- 2) MPAA: Switching the movie-rating control level; N/A, G, PG, PG-13, R, NC-17, X.

Rating		Description
Age	G	General audiences, All Ages admitted
	PG	Parental Guidance suggested. Some material may not be Suitable for children.
	PG-13	Parents strongly cautioned. Some material .may be Inappropriate for children under 13.
	R	Restrict. Under 17 requires accompanying parent or adult guardian(age varies in some jurisdictions)
	NC-17	No one 17 and under admitted.
	X	X is an older rating that is unified with NC-17 but may be encoded in the data of older movies.

4.4 Canada

Press **OK**, to display the following screen.



- 1) Canada English: Switching the English rating control level: EXEMPT, C, C8+, G, PG, 14+, 18+.

Rating	Description
E	Exempt: Includes news, sports, documents and other information programming: talk shows, music videos, and variety programming.
C	Children: Intended for younger children under the age of 8 years. Pays careful attention to themes that could threaten their sense of security and well-being.
C8+	Children over 8 years old: Contains no portrayal of violence as the preferred, acceptable, or only way to resolve conflict; nor encourage children to imitate dangerous acts which they may see on the screen.
G	General: Considered acceptable for all age groups, Appropriate viewing for the entire family, contains very little violence, physical, verbal or emotional.
PG	Parental Guidance: Intended for a general audience, but may not be suitable for younger children (under the age of 8) because it could contain controversial themes or issues.
14+	Over 14 Years: Could contain themes where violence is one of the dominant elements of the storyline. But it must be integral to the development of plot or character. Language usage could be profane and nudity, present within the context of theme.
18+	Adults: Intended for viewers 18 years and older and might contain depictions of violence, which while related to the development of plot, character or themes, are intended for adult viewing. Could contain graphic language and portrayals of secretary and nudity.

2) Canada French: Switching the French-rating control level: E, G, 8ANS+, 13ANS+, 16ANS+, 18ANS+.

Rating	Description
E	Exempt programming
G	General: All ages and children, contains minimal direct violence, but may be integrated into the plot in a humorous or unrealistic manner.
8ans+	General but inadvisable for young children :May be viewed by a wide public audience, but could contain scenes disturbing to children under 8 who cannot distinguish between imaginary and real situations. Recommended for viewing with paren.
13ans+	Over 13 years: Could contain scenes of frequent violent scenes and in tense violence.
16ans+	Over 16 years: Could contain frequent violent scenes and violence.
18ans+	Over 18 years: Only for adult viewing. Could contain frequent violent scenes and extreme violence.

4.5 RRT setting

In ATSC digital TV mode, it can be adjusted

4.6 Reset RRT:

Press **OK** to reset the RRT settings to the factory default values.

5. TV MENU

In this menu, you can adjust digital and analog TV Channels.

Press **▼▲** to select, press **OK** to adjust.

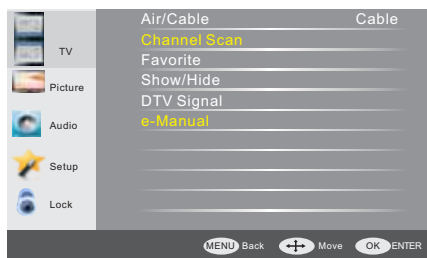

5.1 Air/Cable:

Select Air TV signal or cable TV signal.

5.2 Channel Scan:

If it's the first time you use the TV, you should scan all the TV channels first.

Press **OK** to confirm and to display the following screen.

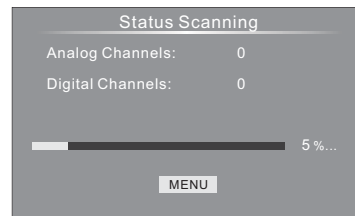
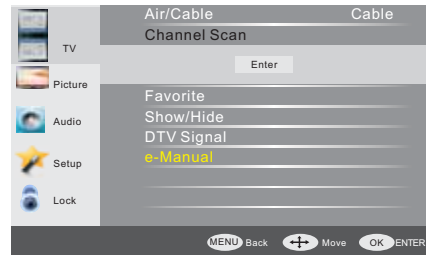

5.3 Favorite:

Press **OK** to choose/delete favorite channels.

5.4 Show/Hide

Press **OK** to display/ hide the current channel.

5.5 DTV signal

Display the DTV signal strength. It can't be selected or adjusted.

5.6 e-Manual

Display the user guide.

6. Multimedia

You can display the Music and Photo files by using the USB port that is located on the rear panel:

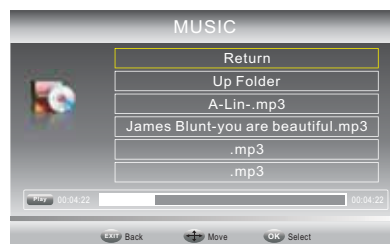

8.1 How to enter into the factory model

1. You can press "source-2-5-8-0" to go into factory setting. Press the key "exit" to shut the factory setting.



content:

1: ADC setup: set ADC value of YUV,VGA. It can also be auto-set. Adopt 100% color bar to yuv and Checkerboard signal to vga.

2:Adjust the brightness and contrast ratio of each signal, which do not affect the value of user's menu.

3: adjust the color temperature and white balance of each signal source.

4: SSC to adjust the spectrum for passing the EMC test.

5:special set

1)2hour off-- for Aging test

2)WDT --watch dog

3)white pattern --set pure color output for the panel, used at the checking and aging test for panel.

4)reset

5)set the recorder

6)set power-on screen display.

6:QMAP adjust :adjust color quality.

7:PEQ set sound EQ

8:sw information: to check the software information

9:UART DEBUG : Access to serial port and connect a computer if set to HK.

10:BMTEST :cpu check the CPU

The last line is SW Ver.No

8.2 How to update software

Haier MSD3393 F/W upgrade with USB SOP

Step 1: Ready for F/W Upgrade

1.1 Prepare a USB memory .

1.2 Copy the software file (merg.bin) from your computer to the USB memory, and remove it from computer's USB port!

Step 2: F/W Upgrade

2.1 AC ON



2.2,then input USB , press "MENU" and choose "update software", and then press "OK".

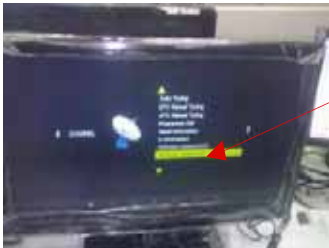

2.3,Now you should choose "Yes",TV begin to update.You should reset TV after update.



Note: When Upgrade on the process, please don't Power-Off!

8.3 How to enter into the hotel model

1. You can press "source-1-0-0-1" to go into the hotel model. Press the key "exit" to shut the hotel model.



















Content:

- 1.Hotel Mode: Hotel mode switch
- 2.Panel Key Lock: Panel key lock
- 3.Max Volume: Hotel mode can adjust the maximum volume
- 4.Start Source: Hotel mode locking TV signal source
- 5.Start Channel: Hotel mode locking program channels
- 6.Start Menu Display: Hotel Mode menu is displayed
- 7.Input Source Change: Hotel mode is to display the Source
- 8.Save to USB: TV related equipment will be copied to the system, U disk ,
to other machines used for cloning
- 9.Loading: U disk data will be cloned into the machine
- 10.Volume Default

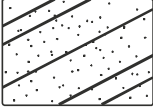
9. Trouble shooting

9-1. Simple check

Trouble phenomenon		Inspection
Picture	Audio	
 Snow	 Noise	antenna position, direction or connection
 Ghost	 Normal audio	antenna position, direction or connection
 Interfere	 Noise	electronic equipment, car/ motorcycle, fluorescent light
 Normal Picture	 Mute	Volume (inspect whether the mute function on the remote control are started, or audio system are correct or not)
 No picture	 Mute	Power cord is not inserted Power switch is not opened Contrast and brightness/volume setup Press standby key on the remote control for inspecting
 No color	 Normal audio	color control
 Scramble	 Normal audio or weak	retune channel
 No color	 Noise	Audio system

Special Explanation: The accessories such as remote control is not belongs to the guarantee.

9-2. Main board failure check

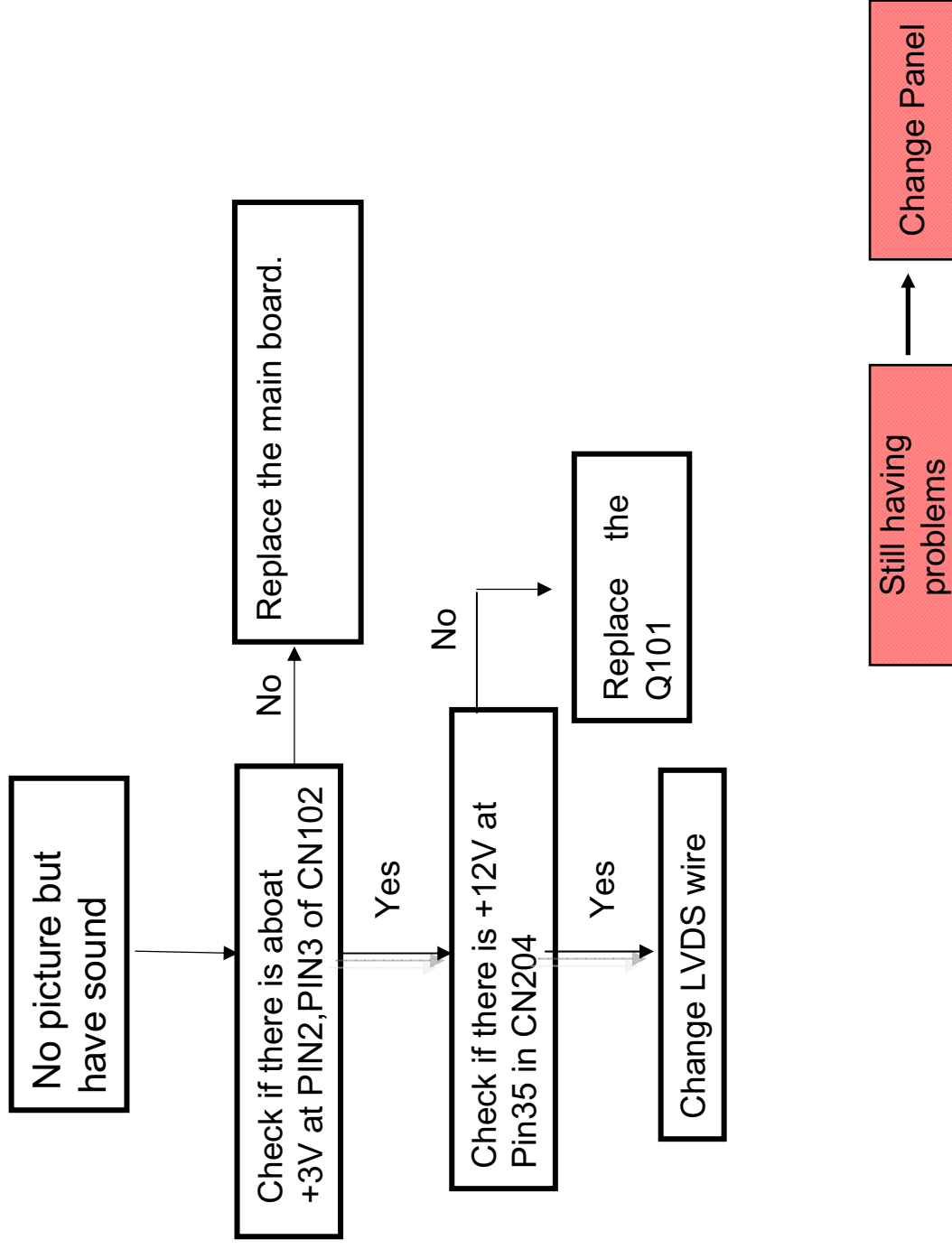

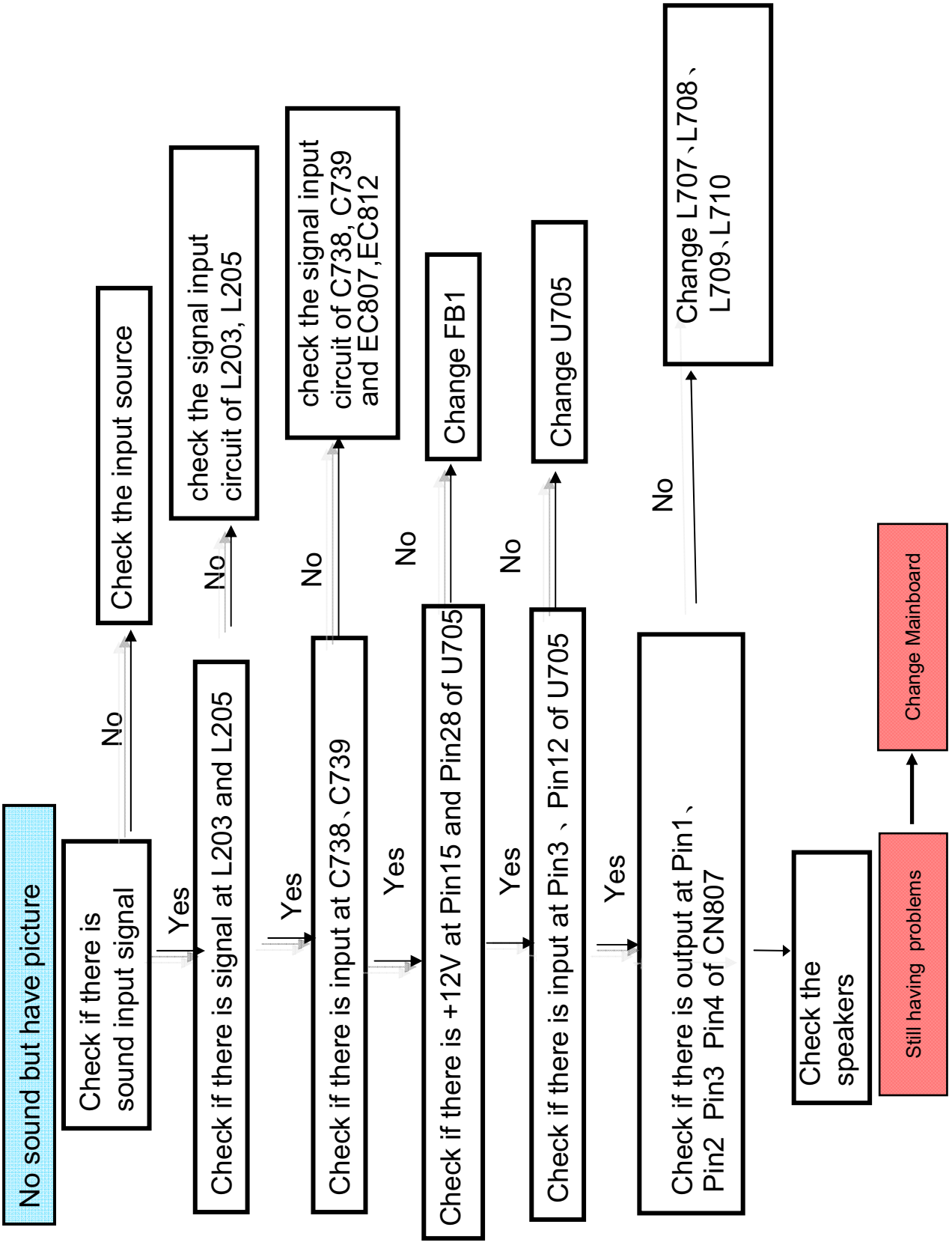

No sound No picture

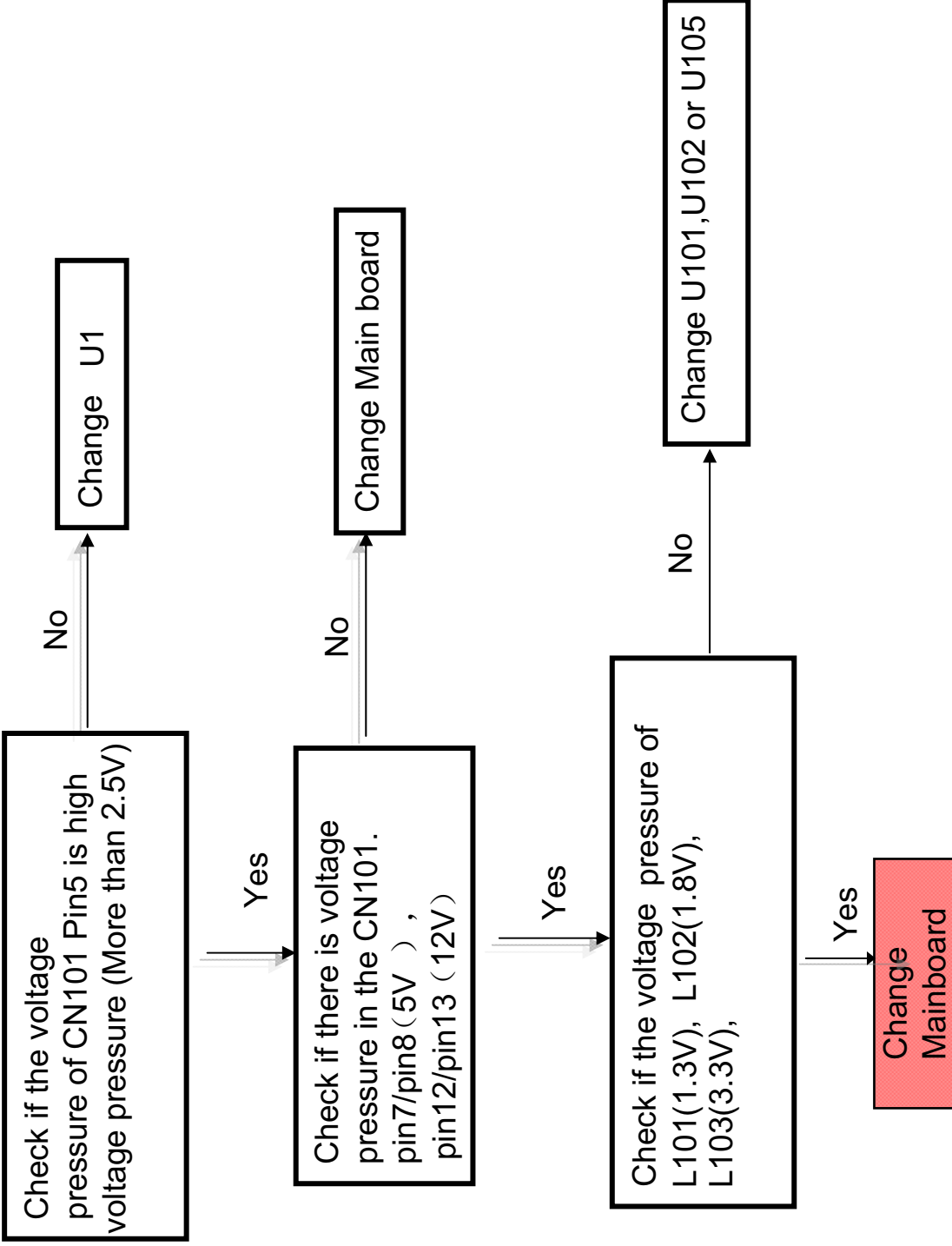

No sound No picture No light

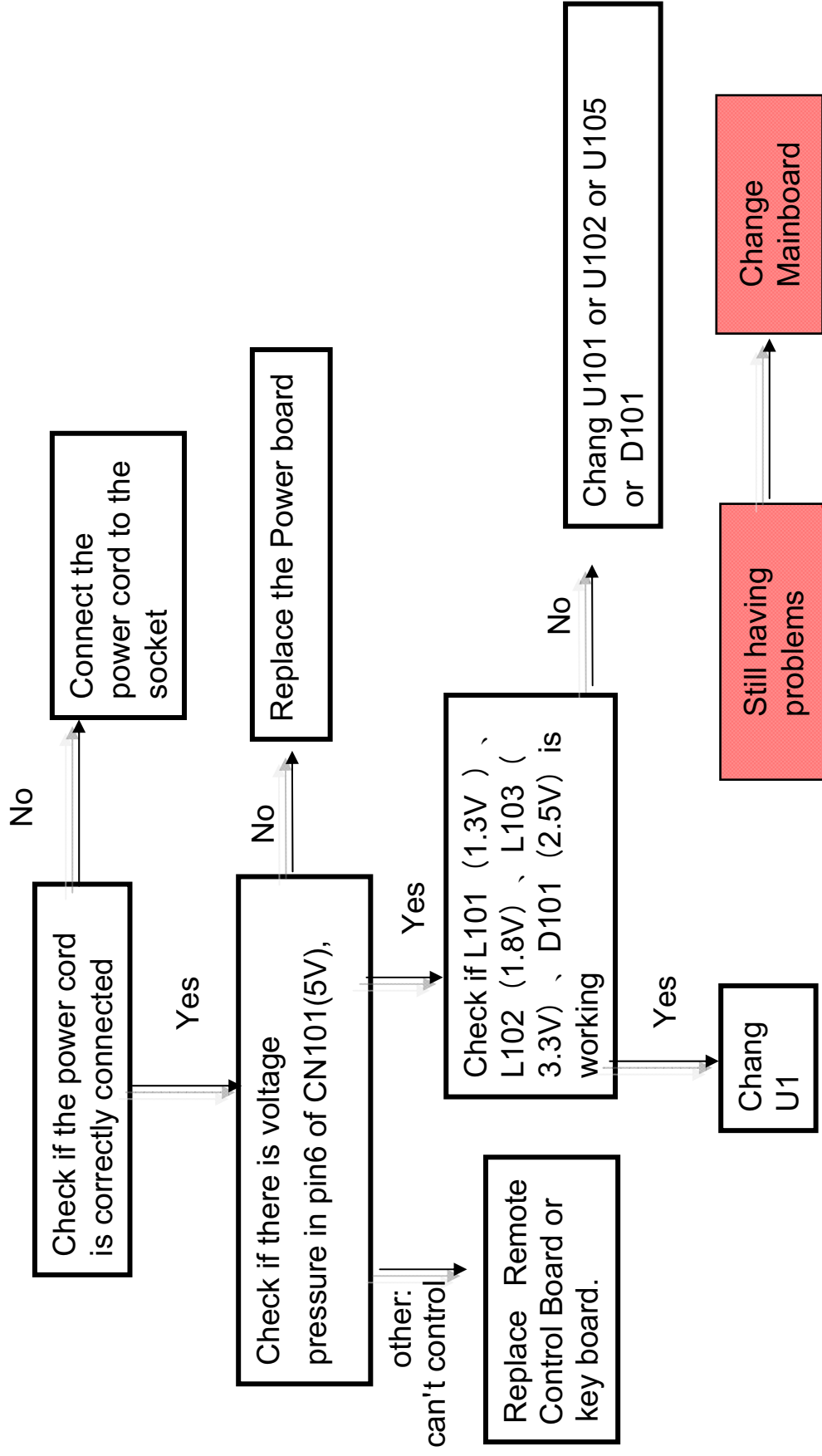

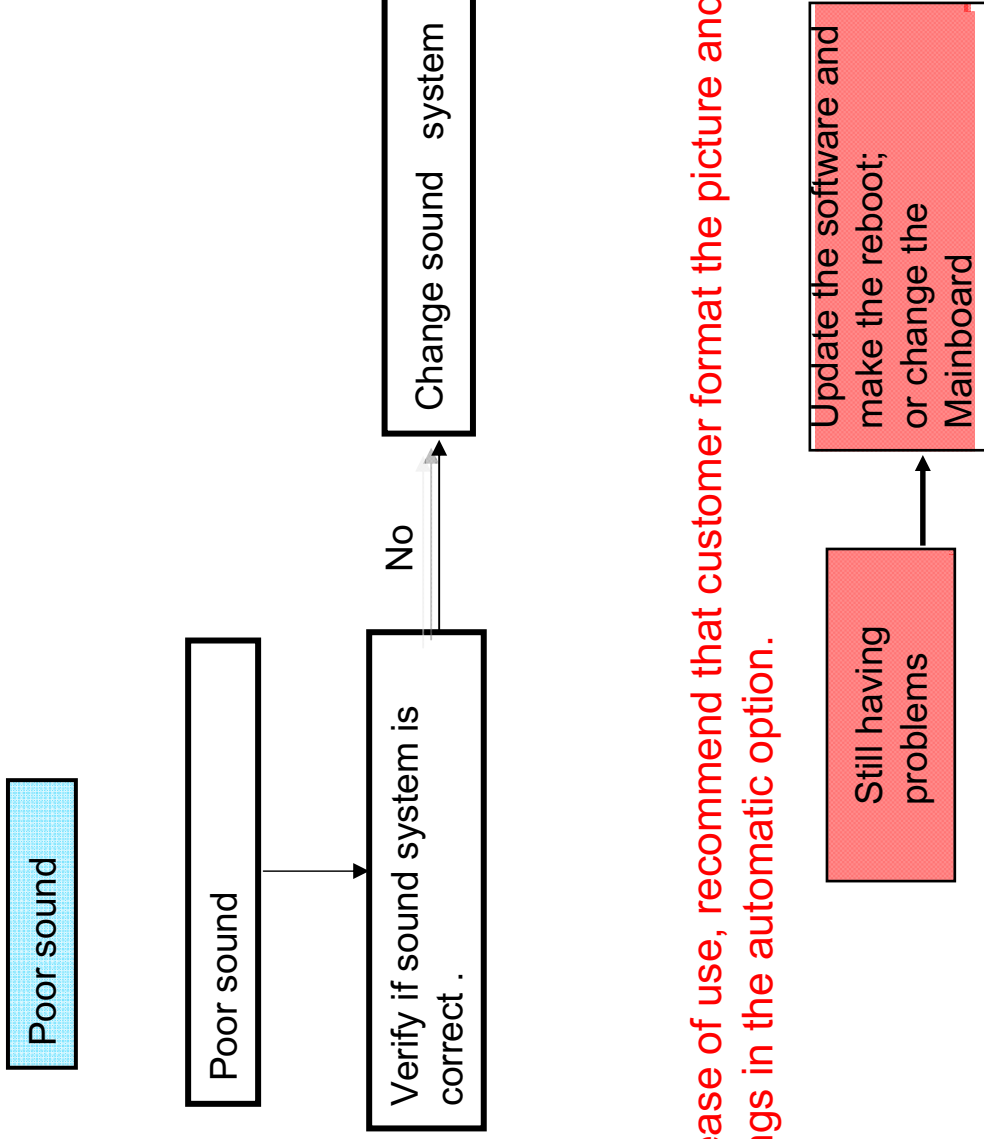

For ease of use, recommend that customer format the picture and sound settings in the automatic option.

No color for some channel program (black and white)

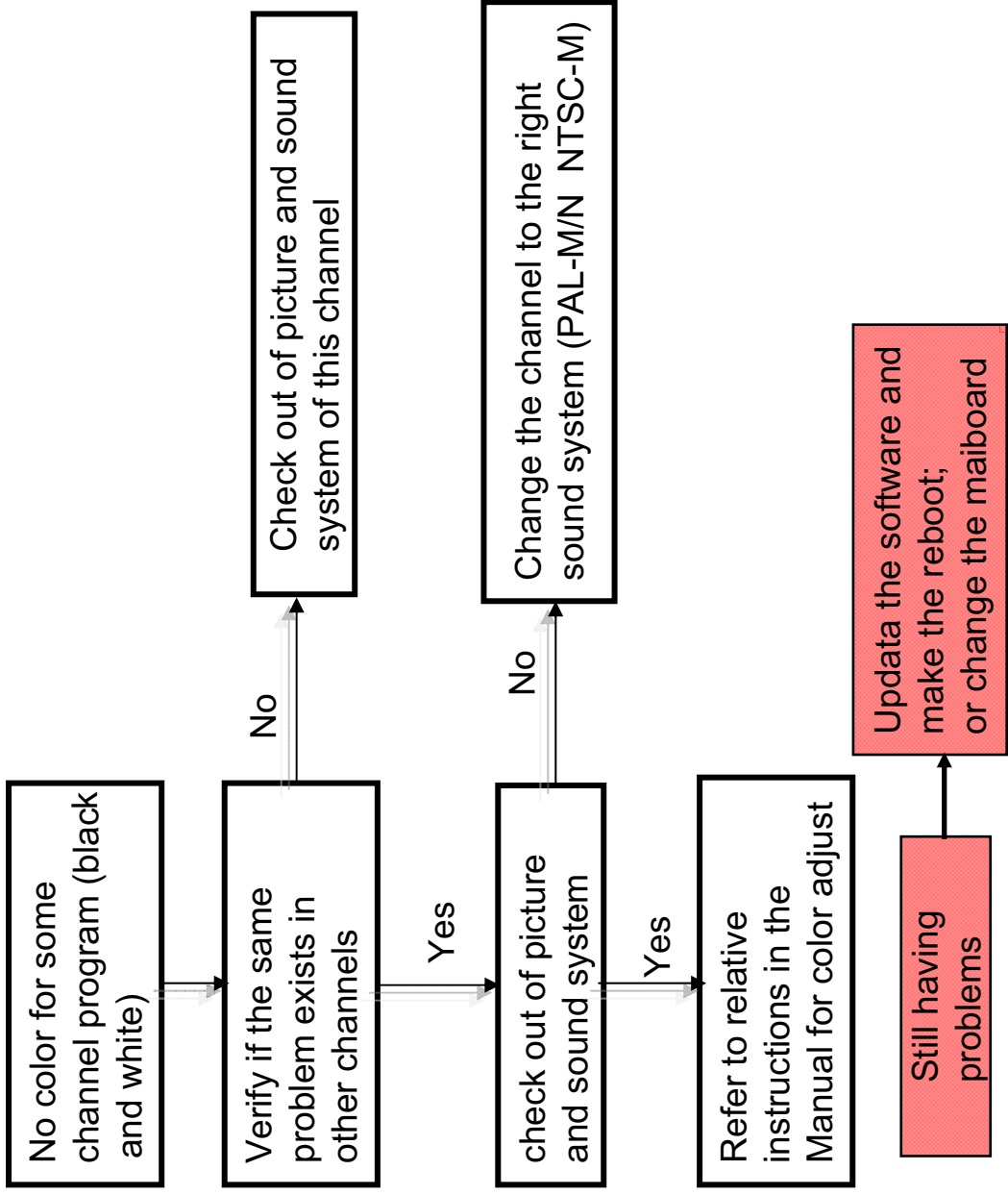

How to know whether the Power board is broken?

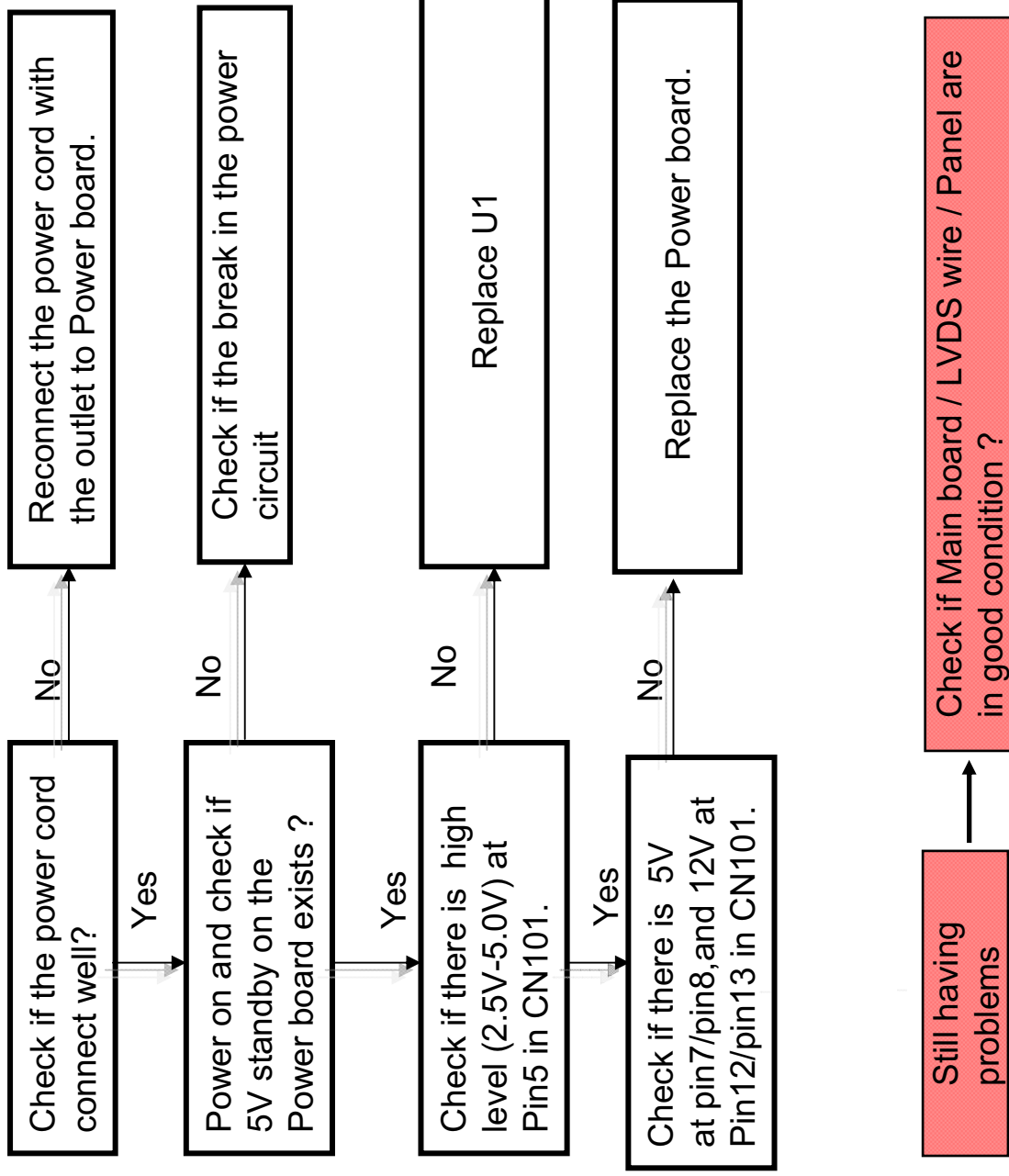

3. Other problem

❖ Mainboard not work

- ❖ 1. check if the power supply have 12V and 5V output.
- ❖ 2. Verify if the DC/DC convertors have the right output (5V, 3.3V, 2.5V, 1.8V, 1.32V).
- ❖ 3. Verify if the Mainchip (MSD3391DS), DDR2, AudioAMP ... solder well;
- ❖ 4. Verify if the FLASH (U17) has the right software and work well;
- ❖ 5. Verify if the Y1 (Crystal) has the right frequency





❖ Panel not work

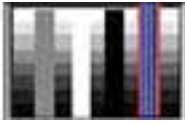
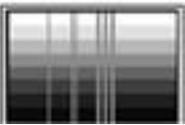
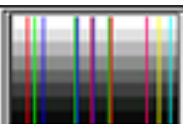

- ❖ 1. check if the voltage input and output of backlight power is working normally.
- ❖ 2. Verify if the Mainboard output the right On/Off signal to power board.
- ❖ 3. Verify if the Mainboard output the LVDS signal to panel T-con board.
- ❖ 4. Verify if the software is the right version of this model.
- ❖ 5. Change the LVDS wire to check if it's broken.

❖ Power board not work

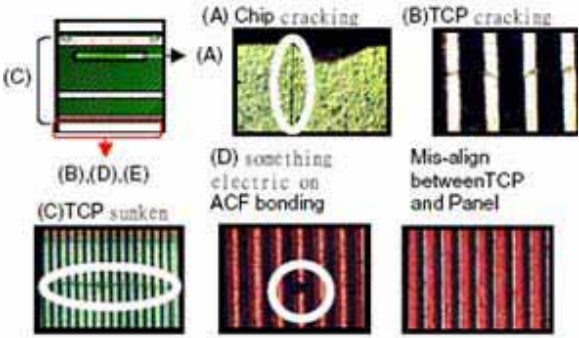
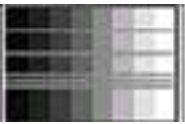

- ❖ 1. Verify if the power cord connect well?
- ❖ 2. check if the power supply if working normally ; check if the power supply of +5V standby is working normally;
- ❖ 3. check if the POWER ON/OFF voltage is high pressure;
- ❖ 4. check if the power supply have +12V/+5V output;
- ❖ 5. Check if Main board / LVDS wire / Panel are in good condition ?

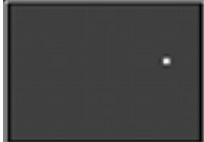
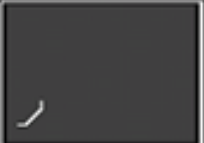
9-3. Pannel failure
Failure Mode



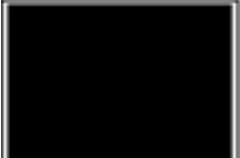

Part	Name	Description	Phenomena	Failure cause
TCP	V B/D	Vertical bar		Block Defect :TCP cracking or cracking Dim or L/D :TCP Sunken :TCP lead cracking :ACF bonding short :Awful environment and something electric enter into LCD :Mis-align between TCP and Panel :Panel failure :TCP failure
	V Dim	Vertal gray line		
	V L/D	Vertical color line(light or dark forever)		
	H B/D	Horizontal bar		
	H Dim	Horizontal gary line		
	H L/D	Horizontal line(light or dark forever)		

Part	Name	Description	Phenomena	Failure cause
Panel or Polarizer	Dot Defect	Bright dot dark dot in pannel		Incoming Inspection Standard
	Polarizer Bubble	Bladder in Polarizer		Bladder between Polarizer and top glass
	Polarizer Scratch	Polarizer Scratch		Tine or rigidity arose
	F / M inside Polarizer	Eyewinker inside Polarizer		Eyewinker inside Polarizer
Circuit	Abnormal Display	Abnormal Display		1.Chip lose action 2.IC ahort or jointiog bad 3.Pannel and vsc connect bad
	Flashing	Bright and dark display alternately		



Failure Mode

Part	Name	Description	Phenomena	Failure cause
Circuit	White Screen	B/L normal, only white screen display		Maybe caused by surge current and EDS
	Black Screen	B/L normal, only Black screen display		
	Flicker	Crosstalk		LCD Vcom imbalance
	Abnormal Color	Only color abnormal		Capacitance improper bring crosstalk inside LCD pannel
	Abnormal Color	Only color abnormal		1.Chip lose action 2.IC short or jointion bad 3.Pannel and vsc connect bad

Failure Mode

Part	Name	Description	Phenomena	Failure cause
	Mechanical Noise	When turn panel, appear cacophony		Caused by Mechanical noise of backlight unit
	Ripple	Connectric circle		Caused by between mechanism and pannel
	B/L off	B/L lose action		*Connect badness between wire and electrode
	B/L dark	B/L brightness darker than normal		*Connect badness Short between wire and electrode
	B/L wire damaged	B/L wire damaged		Operation abnormal or systemic noise
	B/L wire open	Without backlight		Operation abnormal or systemic noise
	B/L shut down	B/L shutdown in sometime		Short bitween lamp housing and wire, Because consume power too much
	F/M	F/M in B/L , white, balck Rotundity or wirelike		F/M in B/L unit

Failure Mode

Part	Name	Description	Phenomena	Failure cause
Mechanical or B/L	Light leakage	Brightness at bottom of LCM brighter than normal		B/L unit badness
	Uniformity	B/L brightness asymmetric		Sheet in B/L unit is uneven
	Mount hole	Lack screw or screw damage		*Lack screw Screw damage

Sincere Forever



Haier Group

Haier Industrial Park, No.1, Haier Road
266101, Qingdao, China
<http://www.haier.com>