

2.4GHz Digital Wireless Colour Video Door Phone User Manual



1. Introduction.....	2
2. Features	2
3. Packing list	2
4. Outdoor Camera.....	3
5. Indoor Monitor.....	3
6. Installation instructions.....	4
7. Operation instructions	6
8. Failure diagnosis.....	9
9. Working Environment.....	9
10. Notices.....	10

- Thank you for purchasing our wireless video door phone system.
- Please read carefully this user manual before using the system and follow manual exactly install and operate the product.

1. Introduction

This system can be used in apartments, villas, hotels, offices, public buildings etc.

The camera is easy to install, you can use the indoor monitor where the wireless signal can reach. Indoor monitor can hang on the wall, cabinet etc. can also be place on the desk, tea table, dining table etc.

2. Features

- (1) 2.4GHz digital frequency hopping and encryption technology, transmission distance up to 300 meters at open area, robust anti-interference;
- (2) Clear night vision;
- (3) Rain shield for the outdoor camera is available;
- (4) 3.5 inch TFT panel and monitoring all the while;
- (5) Hands-free intercom, Unlocked by wireless control;
- (6) 16 chord melodies for option, melody volume is adjustable;
- (7) Date (only one Outdoor Camera with one indoor monitor is available) and time shown on the indoor monitor;
- (8) Indoor monitor store up to 100pcs pictures, expanded-memory can reach 500pcs, pictures mark date and time.
- (9) Brightness and talking volume are adjustable
- (10) MiniUSB charging interface, lithium battery is replaceable and rechargeable,
- (11) One outdoor camera support up to 4pcs indoor monitors simultaneously and vice versa;

3. Packing list

- (1) Outdoor camera Size: 126×93×30mm, rain shield extend 12mm
- (2) Indoor monitor Size: 141×87×20mm
- (3) Power adapter for outdoor camera;
Input: 100-240V 50/60Hz Output: 5V/1A Cable Length: 150cm
- (4) Power adapter for indoor monitor;
Input: 100-240V 50/60Hz Output: 5V/500mA Cable Length: 80cm
- (5) Lithium battery of indoor monitor (6) User manual
- (7) Screws and stoppers for the installation of outdoor camera

4. Outdoor camera

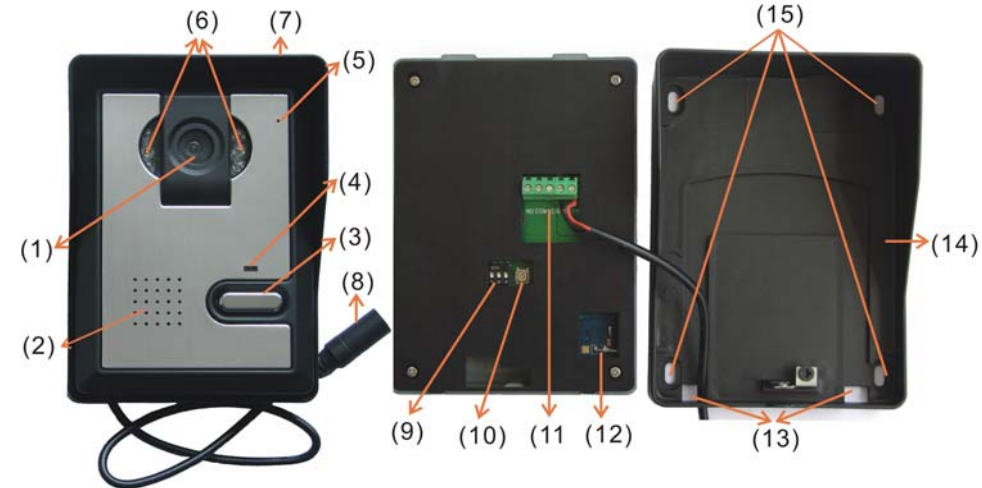

- (1) Camera Lens (2) Speaker (3) 'Call' Button (4) Indicating light (5) Microphone
- (6) Infrared light (7) Rain shield (8) Power Interface (9) Toggle switch
- (10) 'Code' Button (11) Lock Interface (12) Obligate area for welding antenna
- (13) Wire hole (14) Back box (15) Fixed slot

5. Indoor Monitor

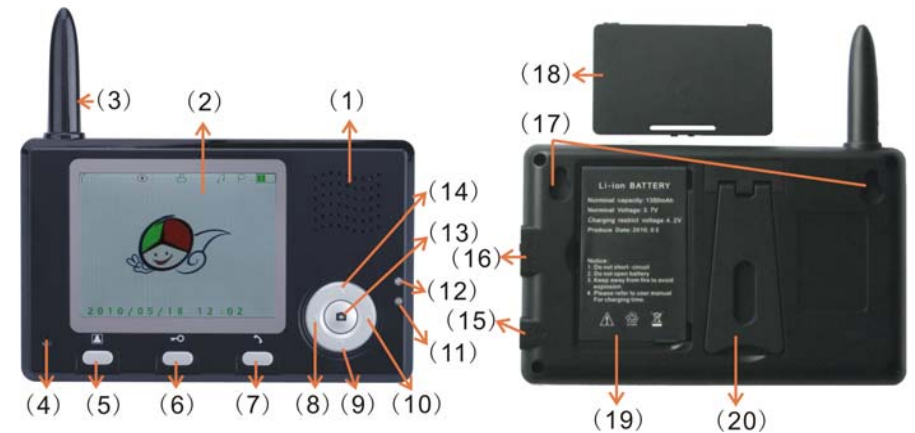

- (1) Speaker (2) 3.5 inch TFT panel (3) Antenna (4) Microphone
- (5) 'Monitor' button (6) 'Unlock' button (7) 'Talk' button

- (8) ◀ Left button (9) ▼Down button (10) ▶Right button (11) LED 1 (12) LED 2
 (13) 📷 'Camera' button (14) ▲ Up button(15) MiniUSB charging interface
 (16) Power switch (17) Fixed slot (18) Battery lid (19) Lithium battery (20) Bracket

6. Installation instructions

The outdoor camera should be installed at the shielded position to be free from direct shining of strong light and raining, the height for installation is recommended to be 1.5m~1.7m for camera to focus on the best monitoring range. If there are obstacles between the installation position of outdoor camera and indoor monitor, the signal will be weakened, check the sign of monitor when install the outdoor camera to get the best position.

If wiring needs to go through wall, the plug shall be first wrapped with tape so as to avoid the sand or dirt going into the plug thus resulting in malfunction.

- (1) Take off the screw on the bottom, remove the back box and fix it.



- (2) Choose unlock wire and adaptor of power-off or power-on unlocking. User must according to the power of the lock to select appropriate power lock, set unlock time according to the lock parameter, unlock signal wire pull down or penetrate wall from the bottom hole of back box (Pic 2),

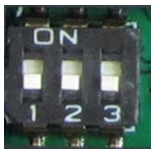

- A Unlocking time is 1 second is default (the first switch is on the top, the rest two is below)
 B Unlocking time is 4 seconds (the second switch is on the top, the rest two is below)
 C Unlocking time is 8 seconds (the third switch is on the top, the rest two is below)

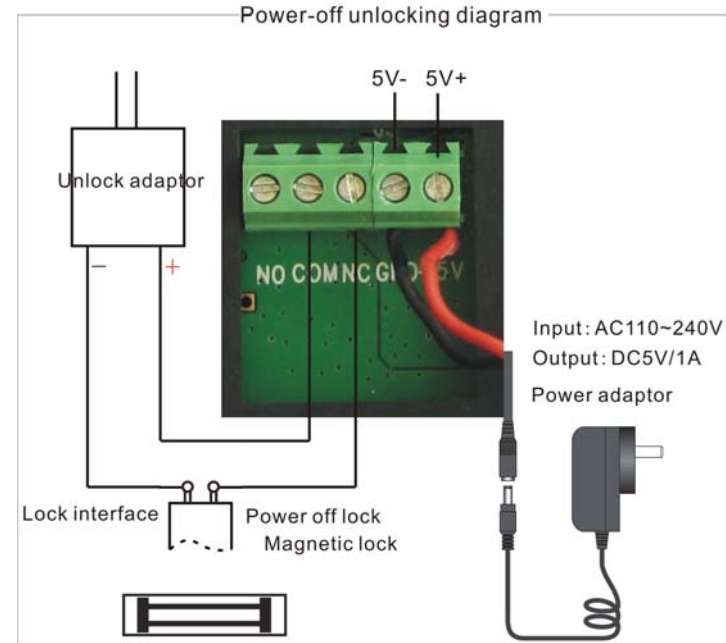
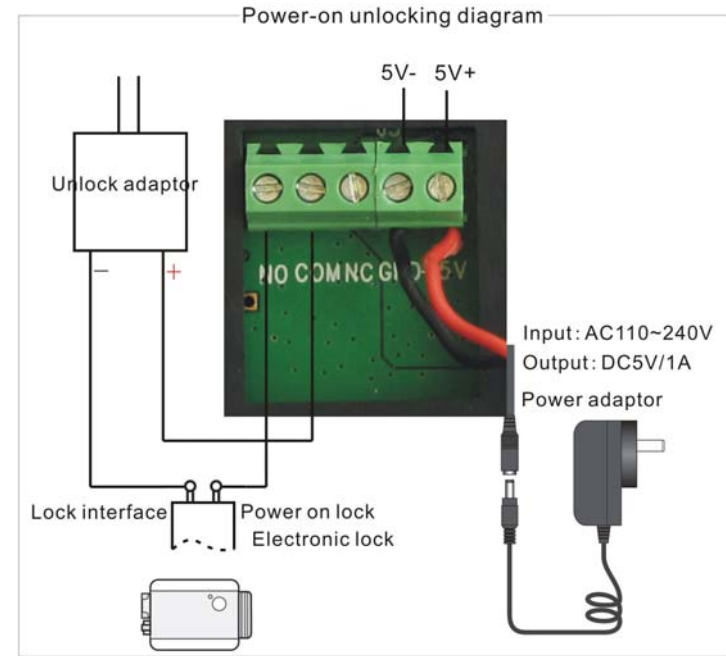

(Pic 2)

- (3) Embed the outdoor camera to back box and use the screw to fix, plug the adaptor to power cord, plug the power supply cord, the Indicating light show red.

Note: Before install outdoor camera, please plug off the power supply cord, We will not provide unlock adaptor.

7. Operation instructions

Note: the system in working condition, if there is no blocking wall between indoor monitor and outdoor camera, must keep above 6 meters between two units to avoid producing 'whistle' sound .

A Setting

(1) Date and time

When indoor monitor is not in intercom mode, press keys for 3 seconds, left the battery symbols show "T" character on the screen, users can set the date (year/month/day) and the current time (hour/min) : time format for 24 hours, Date only one Outdoor Camera with one indoor monitor is available, press ◀, ▶ button to set, press ▲, ▼ button to adjust the time and date in grey.

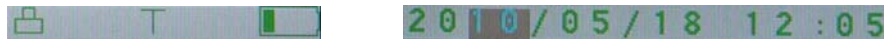

(2) Melody and volume

When indoor monitor is in no-intercom mode, press ▶ button to select one of the 16 chord melodies for the bell and sound the melody selected simultaneously, press ◀ choose to the volume of melody, adjust level: 1-2

The 16 chord melodies are Ding-dong, To Alice, Westminster bell, Butterfly lovers, The cygnet, Red river valley, My heart will go on, Turkey's march, small dance, congratulations you, William's prelude, love romance Hudson, Memory, The Little Mermaid, Green sleeves, Romeo and Juliet

(3) adjust talk volume

In the intercom mode, press ◀▶ adjust the talk volume, adjust level: 0-7

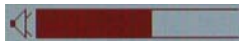

(4) Brightness

In the intercom mode and indoor monitor has dynamic image from outdoor camera, press ▲, ▼ adjust brightness, adjust level: 0-7



B Operation

(1) Indoor monitor turn on/off

Turn on: Turn the power switch to "ON", LED 1 display red, and rings the melody.

Turn off: Turn the power switch to "OFF", LED 1 light off.

signal of communication message max is level 6. There is also signal of battery max is level 4.

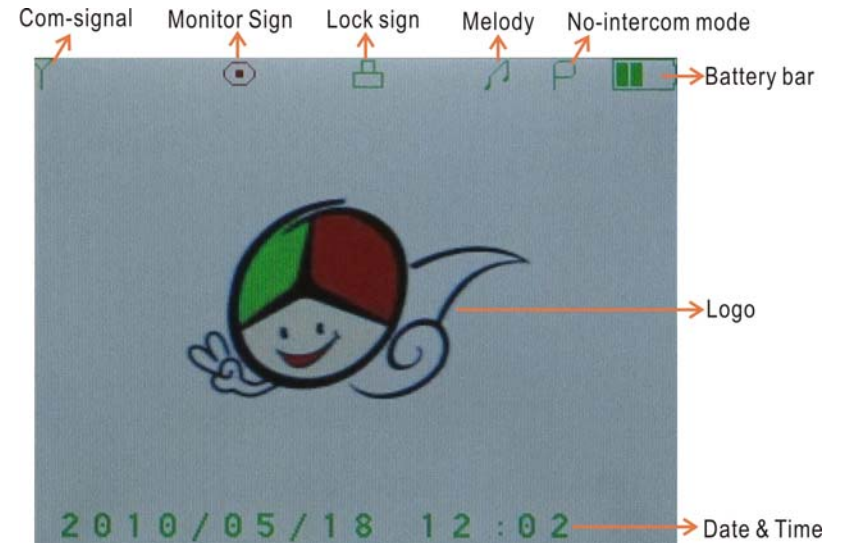



(2) Talk, Unlock

The visitor presses the "call" button of the outdoor camera, all indoor monitors will sound melody and show the image of visitor.

- A. Press 📞 button of one indoor monitor to speak to visitor before unlocking. Other indoor monitors can see the image but not hear sound of the visitor. If you want to allow other indoor monitor to talk, press 📞 button to close the current dialogue, then another indoor monitor press 📞 button to speak to

visitor.

Only one indoor monitor for each dialogue.

When under intercom mode, press  button to release the door lock, the unlock signal shows on the screen, when release  button, the unlock signal will disappear.

Press  button to turn off the screen and enter standby mode, or it will turn into standby mode automatically after 30 seconds.



B. If do not want to receive the visitor after seeing the video, no operation or press the  button to turn off the screen and then enter into standby mode.



Indoor monitor enter into the standby mode after 30 seconds if no any operation.

Note: if you use multiple indoor monitors, please keep distance between indoor monitors to avoid affecting intercom effect.



(3) Monitoring



For one camera or more cameras with one indoor monitor, if there is no calling from the outdoor camera, and the indoor monitors in standby mode. User can press the  button once to wake up the indoor monitor; press  button again to enter monitor mode and monitor the outdoor as long as you like, monitor signal will display on the screen. Press  button again to quit and close the screen.

For several cameras with one indoor monitor, Under monitor mode, press  button show the image from the CAM1, CAM2, CAM3, CAM4 (if the system has) in sequence; At the last camera, press  button again to quit and close the screen.

Note: If one outdoor camera using, Please do not press other outdoor camera to disturb the system.

(4) Charge

The first to be charged more than 5 hours to activate the lithium battery, after that charge 3 hours every time, up to 100 hours of standby time.

LED 2 turn red when charging, turn green when the battery is filled, the color of battery indicator will change from green  to red  when low power.

C Take picture



(1) Take picture

When has video from outdoor camera, pressing  button to take pictures, one press for one picture, and then quit the picture mode





If the user isn't in or no any operation, all indoor monitors save the image of outdoor automatically after 10 seconds and enter into the standby mode after 30 seconds.

It will replace first picture if exceed available memory when take a new picture.

(2) Browse picture

Press the ,  button to view the stored pictures under the no-intercom mode, then press  button or after 10 seconds to quit viewing mode.

(3) Delete picture

First turn off the indoor monitor, then press  and  button together, turn on the indoor monitor, press  and  button still the screen display text: 'Delete all photo, please wait' 'no photo , Please Power off', After that all pictures have been deleted. Please turn off the indoor monitor, then turn on the indoor monitor that will work.

(4) Delete picture

Must be charged more than 5 hours for first two times to activate the lithium battery, after that charge 3 hours every time, up to 100 hours of standby time.

8. Working Environment

(1) Working temperature: -15°C — $+55^{\circ}\text{C}$ (2) Working humidity: $\leq 85\%$

9. Notices

- (1) Please don't cover anything on the Microphone or speaker when there is conversation.
- (2) Please always use the specified electric source power supplier adaptor, or that with the same type (same standard voltage and electric current). Using the adaptor unspecified may lead to the damage of the circuit and component of the product.

- (3) Do not attempt to service this product yourself as opening or removing covers may expose you to dangerous voltage or other hazards. Refer all servicing to qualified service personnel.
- (4) Please strictly follow the user manual before you install and test this product. If there is any question, please contact our tech support and customer service;

10. Failure diagnosis

Malfunction	Checking	Debug
Fail to start the product	If turn the switch to the "ON"?	Turn the switch to the ON
	If the power of Lithium-on batteries is not enough?	Charge the Lithium-on battery
Fail to charge	If the plug of power adaptor correctly plug into miniUSB?	Re-connect the devices and power adaptor
	If the power adaptor correctly get through the 100-240V AC electricity?	Re-insert the plug to make power adaptor get AC electricity.
Intercom mode no voice	If the talk volume is adjusted to be the least?	To adjust the talk volume to be suitable.
The image is flashing or noise	If the indoor device is close to induction cooker and microwave oven which has magnetic wave?	Keep indoor monitor far away from these things which has magnetic wave.
Indoor monitor no signal	If the outdoor camera doesn't connect the power?	To connect the outdoor camera power
	If the outdoor camera is far away from the indoor monitor?	Keep the distance in 60 meters within (stopped by multi-wall)
	If there is other strong magnetic space bother?	Keep indoor monitor far away from the strong magnetic space