

HQ²⁴ Fusion

USER MANUAL



Designed by a Quilter, for Quilters.®

04/14/09

© 2009 Handi Quilter, Inc.

Safety Section

This device complies with Part 15 of the FCC Rules. Operation is subject to the following two conditions: (1) this device may not cause harmful interference, and (2) this device must accept any interference received, including interference that may cause undesired operation.

Please note: Do not operate your HQ Fusion™ quilting machine until you have completely read the information contained in this manual. Please keep all packaging and order information for warranty purposes.

1. The HQ Fusion™ is very heavy. Never attempt to lift it alone – always use two people when lifting.
2. Always unplug the HQ Fusion™ from the electrical outlet when performing any maintenance, changing the needle, removing thread locks, or when left unattended.
3. Keep fingers away from all moving parts. Use caution around the needle or sharp external components.
4. Change the needle often. Do not use bent or dull needles.
5. Switch the power off when making any adjustments in the needle or bobbin area, such as threading the needle, installing the bobbin case, or when oiling or cleaning.
6. Never drop or insert foreign objects into any opening.
7. The HQ Fusion™ should only be used indoors away from moisture.
8. The HQ Fusion™ should not be stored or used in extreme temperatures.
9. Use the HQ Fusion™ only for its intended use as described in this manual.
10. Use only attachments recommended by the manufacturer.
11. To disconnect from the wall outlet, push the switch to the off position, then remove the plug from outlet pulling from the plug, not the cord. Never operate the HQ Fusion™ if the cord is damaged or not working correctly. If a mechanical or electrical problem is encountered, return the HQ Fusion™ to the nearest authorized service center or the manufacturer for examination, repair, electrical or mechanical adjustment.
12. It is not recommended that the HQ Fusion™ Quilting Machine be used with any machine quilting frame other than those recommended or manufactured by Handi Quilter.

Quick Facts

Description	Specification
Sewing Speed – Manual Mode	110 – 2200 SPM
Sewing Speed – Regulated Mode	0 – Full Speed
Needle Bar Stroke	35.3 mm
Sewing Foot Stroke/Lift	5 mm
Needle System	135x7 Standard 134 R Long Scarf
Needle Sizes	14/90 – 19/120
Lubricating Oil & Greases	Kluber Lubrication
Dimensions of Sewing Machine Throat	9.625" x 24.00"
Rate Voltage/Power Consumption	90 – 264 V _{AC} , 47 – 63 Hz, 400 Watts
Power Consumption of LED Lights	24 Watts
Hook System	Custom Manufactured, Rotary, Large Bobbin
Bobbin Type	Class M
Motor Type	Brushless DC
Automatic Needle Positioning	Up and down, full stitch and half stitch

Disclaimer

Handi Quilter and its Representatives are in no way legally responsible or liable for damage to the HQ Fusion™ when used improperly or not in accordance with the guidelines stated in this manual or when used on Machine Quilting Frames not recommended by Handi Quilter.

HQ Fusion Package 1 Contents

Please keep your original box and packaging.

Contents of Package 1

1. Bobbins (5 pieces)
2. Needle (135x5) size 16
3. Needle (135x5) size 18
4. Bobbin Case
5. Thread Mast
6. Oiler
7. Power Cord
8. Hex Wrench
9. Memory Card Kit
10. Instructional DVD
11. Instruction Manual
12. HQ Fusion™ Quilting Machine

Optional Accessories Available

1. Micro Handles
2. Ruler Base
3. Laser Stylus and Clamp
4. Laser Stylus Post

HQ Fusion™ Components

Front Side Diagram A

1. Thread Mast
2. Thread Guide A
3. Thread Guide B
4. Three Hole Thread Guide C
5. Thread Guide D
6. Tension Assembly
7. —Strip— Thread Guide D
8. Take Up Lever
9. Thread Guide F
10. Front Casing/Frame
11. Back Hand Wheel
12. Front Hand Wheel
13. Side Laser Stylus Post Hole

Diagram A

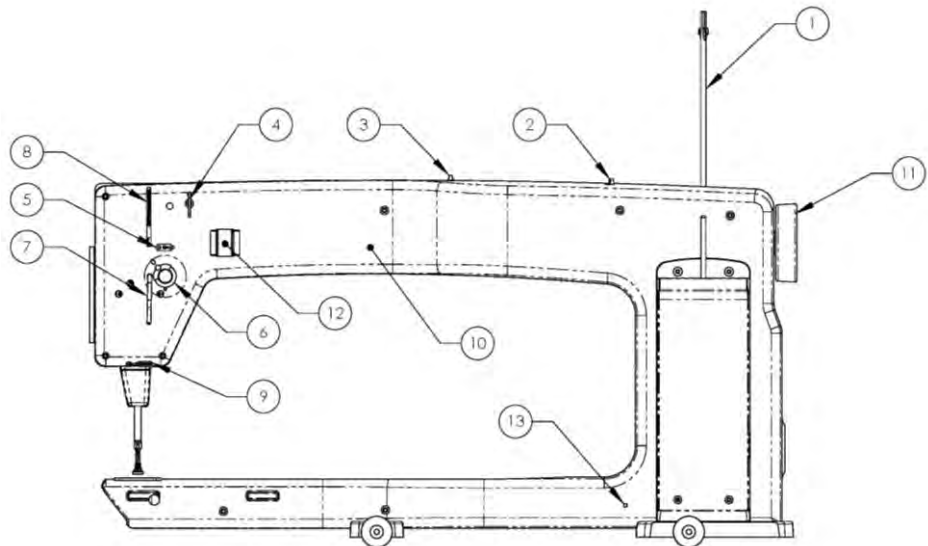

**Back Side
Diagram B**

- 14. Hopping Foot
- 15. Needle
- 16. Needle Bar Thread Guide
- 17. Needle Bar
- 18. Presser Bar
- 19. Needle Plate
- 20. Front Handle Serial Port Connector
- 21. Ruler Base Position Guides
- 22. Front Wheel Base
- 23 Wheels (4)
- 24. Back Casing/Frame
- 25. Rear Wheel Base
- 26. Front Threaded Handle Holes
- 27. Top Laser Stylus Post Hole

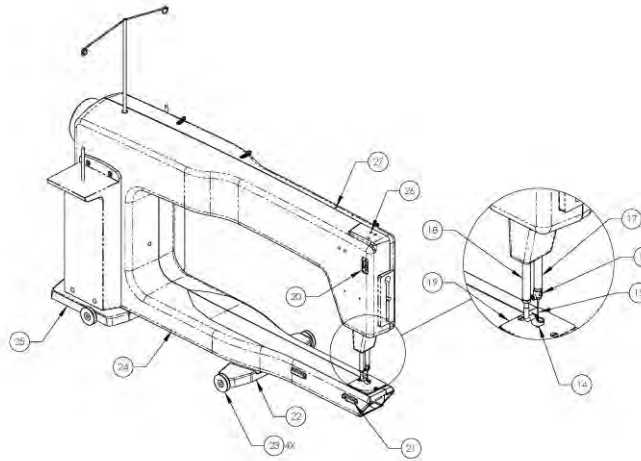
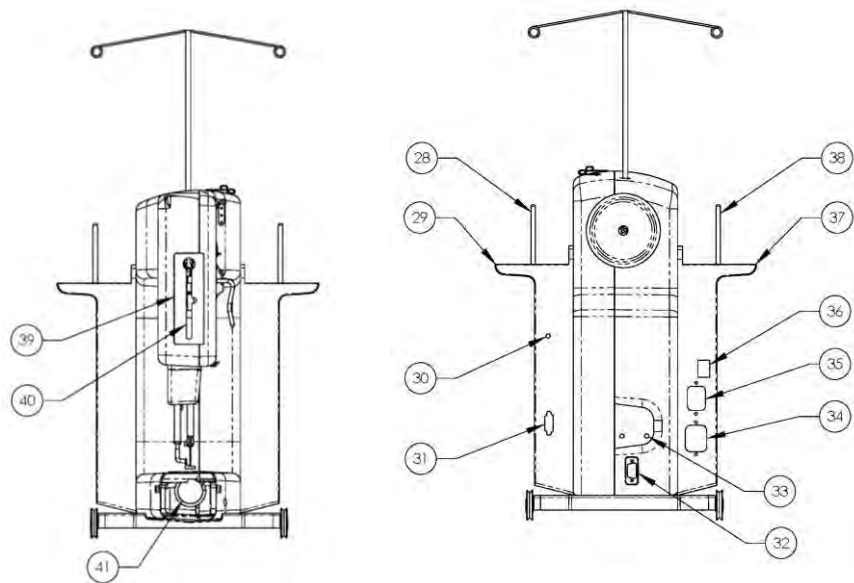

Diagram B

**Rear/Front
Diagram C**

- 28. Spool Pin 1
- 29. Electronic Control Pod
- 30. Laser Stylus Power Connector
- 31. Serial Port for Stitch Regulator
- 32. Rear Handle Bar Serial Port
- 33 Rear Threaded Handle Holes
- 34. Accessory Power Outlet
- 35. Power Cord Connector
- 36. On/Off Switch
- 37. Power Pod
- 38. Spool Pin 2
- 39. Micro Handle Mounting Bracket.
- 40. Micro Handle Removable Plug
- 41. Bobbin Assembly

Diagram C



Note: A Handi Quilter “Welcome” DVD is included with your HQ Fusion™ Machine. Review the DVD and these instructions to better understand how to set up and use the HQ Fusion™.

Installation

1. Place the carriage on the table rails ensuring that the Carriage Encoder Assembly will be toward the back of the machine (the power cord side of the machine). The back side of the carriage has an encoder assembly attached to the rear cross-piece. Be sure to place the carriage on the frame correctly (see Photo 1).
2. Place the machine on the carriage.
3. Plug the Ribbon cable into the Carriage Encoder Assembly. The connector is keyed, so make sure the keyed portion of the cable connector aligns with the keyed portion of the encoder connector.
4. The remaining length of cable comes back under the Power Pod from the Rear Encoder Assembly, behind the machine, and into the 9-pin serial port of the machine (see Photo 2).

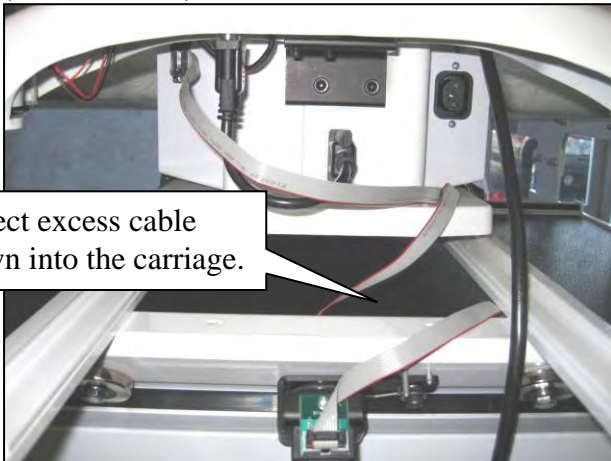

Photo 1

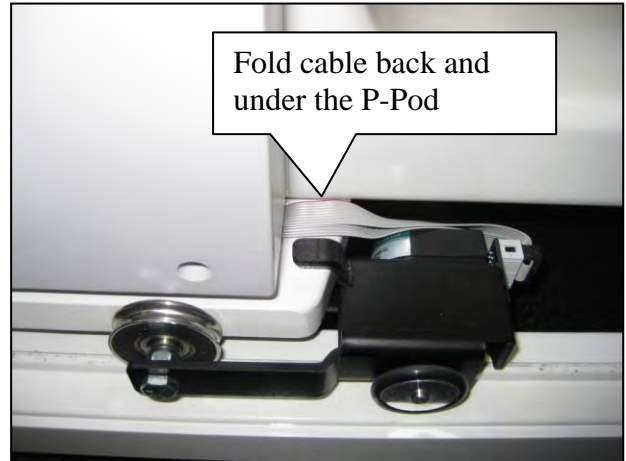

Photo 2

5. **REMEMBER** that if the machine is to be removed from the carriage, the cable must be disconnected from the Carriage Encoder Assembly. The other two connectors on the cable should remain in place. Failure to unplug the cable when removing the machine from the carriage could result in damage to the cable, encoders, and carriage.

Installing Front Handles

Caution: Unplug the HQ Fusion™ from the electrical outlet. All power to the machine must be turned off when installing the front handles. Failure to do so can result in damage to the machine.

Locate the three long bolts and the appropriate Hex wrench. To install the handles, tilt the screen forward. Line up the holes on top of the handles with the pre-drilled holes on top of the machine. Slide a single bolt into one of the holes until it stops. Hand-tighten the bolt enough to secure the handles to the top of the machine, but still allow you to rotate the handles. Secure the short 9-pin handlebar serial cable to the serial port on the back casing of the machine (see diagram B, #24). You may need to rotate the handle slightly to allow access to the finger screws. Use the finger screws to tighten the 9-pin connector in position. If necessary, a flat screwdriver may be used to gently secure the connector.

Rotate the handles back to their correct position and insert and hand tighten the remaining two handlebar bolts. Use the included 5 mm Hex wrench to securely fasten the handles to the front of the machine.

Installing Rear Handles

Check that the HQ Fusion™ is unplugged from the electrical outlet. All power to the machine must be turned off when installing the back handles. Failure to do so can result in damage to the machine.

The rear handlebar comes mounted with three screws to the “L” bracket. Line up the two holes in the “L” bracket with those on the rear of the machine. Slide the short bolts into holes until they stop. Hand tighten, and then use the Hex wrench to securely fasten the handles to the back of the machine.

Once the two bolts are in place, plug the 9-pin connector into the serial port underneath the rear handles (see diagram C, #33). Ensure the pins are lined up so they are not damaged when the plug is pushed in. Push the plug securely in place.

Note: After the handles have been completely installed and plugged in, test them by turning the HQ Fusion™ on/off switch to “”. If nothing is displayed, press the display power button on the top right of the touch-screen display. If the display still does not turn on, check that the handle bar cable on the side of the machine is plugged in securely, that your machine is turned on, and that the power cord is plugged into the machine as well as a power source.

Installing the Power Cord

Insert the cord into the top power connector on the rear of the machine. Plug the three-prong end into a power source (see Photo 3).

The lower power connector is for powering other attachments developed by Handi Quilter.



Photo 3

Inserting (or changing) the Needle

Check that all power is turned off.

1. Move the needle bar to the highest position by turning the front or rear hand wheel or pressing the needle up/down control on the handles (prior to turning the power off).
2. Loosen the needle-bar-clamp thumb-screw (see Photo 4).
3. With the scarf (small ground-out section/dip on the back side of the needle just above the needle eye) facing toward the back hand-wheel side of the machine, and the long groove down the front of the needle facing the bobbin case side (see diagram E), push the needle all the way up into the needle bar – until it can go no farther.



Photo 4

4. *Carefully* tighten the needle bar clamp screw. Over-tightening the needle-clamp screw will result in damaged threads stripping the hole. Stripped holes and damaged threads are not covered under warranty. Another side-effect of damaged threads from over tightening is that the needle may be very tight when inserted up into the needle bar. To avoid over tightening the screw, **finger tighten only.**

Note: Changing the needle is recommended for each new quilt loaded on the machine or any time the needle becomes bent, dull or burred.

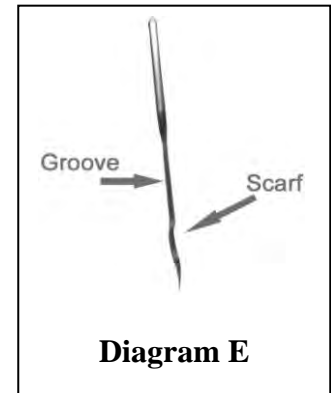

Diagram E

Important: Check the needle to confirm it is fully inserted. The needle bar has a stop/sight hole above the needle bar clamp screw – make sure the needle is touching the top of the stop/sight hole. If it is not, the machine timing will be off and it may be possible for the needle to collide with internal parts causing damage not covered by warranty.

Adjusting the Hopping Foot

The foot is adjusted at the factory and should not be moved without consulting the manufacturer.

Installing the Thread Mast

Locate the threaded hole on top of the machine near the rear by the hand wheel. The thread mast comes with the washer and nut on it. Remove the nut and washer, replace the nut onto the mast and then place the washer under the nut and onto the machine painted surface. The washer protects the painted surface when the nut is tightened. Tighten the mast clockwise until it is securely in place. Use the nut to secure the mast to the machine.

Note: The eyelets of the thread mast MUST be centered over the spool pins – so the cone will not pull, turn or tilt causing thread tension problems (see Photo 5).

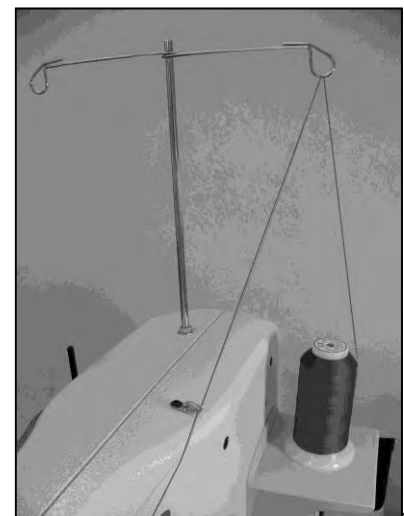

Photo 5

Installing the Laser Stylus

Begin by locating the laser stylus guide post, the laser holder and the laser stylus.

To attach the laser stylus to the top of the machine:

1. Locate the threaded hole on top of the machine near the front (see diagram B, #20). The laser stylus guide post comes with the washer and nut on it. Remove the nut and washer, replace the nut onto the post and then place the washer under the nut and onto the machine painted surface. The washer protects the painted surface when the nut is tightened. Tighten the post clockwise until it is securely in place. Use the nut to secure the post to the machine. Be sure the laser stylus is inserted into the laser clamp.
2. Slide the laser clamp over the post to the desired height.
3. Plug the laser into the top port on the side of the front electronic control pod (see diagram C, #29).

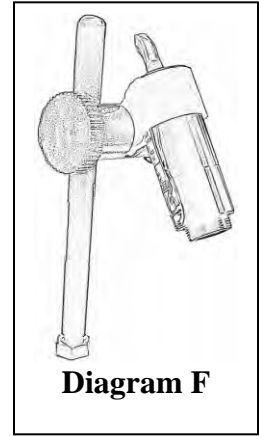

Diagram F

To attach the laser stylus to the side of the machine:

1. Place the nut on the laser stylus guide post with the washer under it and thread the laser guide post into the threaded hole (see diagram A, #14), near the rear wheel base. Turn until securely in place. Lock in place with lock nut – the washer will be under the nut to protect the machine paint. (see Photo 6). An unused spool pin can also be used to mount the laser.

Follow steps 2-4 above



Photo 6

Laser Stylus Safety and Use Guidelines

Theory of Operation

The laser stylus projects a straight laser beam visible as a dot on surfaces it hits. The laser dot is used as a guide or stylus allowing you to stitch the same pattern onto a quilt that is being traced with the laser dot.

Laser Operation and Use

There is not a separate on/off switch for the laser. Power is supplied to the laser when it is plugged into the HQ Fusion™. Be sure the laser is attached to the HQ Fusion™ and pointed downward toward the table before connecting it to the port. Never point it in a direction that would project the beam into someone's eyes. If the laser should cease to operate, check to ensure the plug is firmly seated into the HQ Fusion™ laser port.

Caution: Use of controls or adjustments or performance of procedures other than those specified herein may result in hazardous radiation exposure.

Laser Focus/Laser Image Size

This high quality laser is focusable. The laser is focused by simply grasping the threaded housing surrounding the lens and turning clockwise or counter clockwise (see Photo 7). The laser image can be adjusted bigger or smaller. The direction of rotation needed is determined by the distance of the laser from the intended focal plane. Experiment by turning the threaded end to achieve your desired focal size.



Photo 7

Clamp Adjustment

The laser attaches to a mounting post. The post may be vertical or horizontal. The clamp is designed to articulate any direction by rotating the clamp on the post and pivoting the laser up or down. To make an adjustment, simply loosen the black thumbscrews, position, and retighten.

Location of Laser Labels

The label is attached to the case of the laser and contains an arrow which indicates the direction the laser light will shine when energized. The label must remain in place on the laser. Removal of the label will void the laser's warranty.

Threading the Machine

1. Place a cone or spool of thread on the spool pin. Pass the thread through **the thread mast** eyelet from back to front, continuing to thread guides **A and B**.
2. Continue to three-hole thread guide **C**. Wrap all three holes from back to front, back hand wheel side to needle side (see Detail 1 below).

Note: The purpose of this guide is to prevent loops of thread coming off the thread cone from going into the top tension as a knot causing thread breakage and bad tension. For most threads on a cone, it is important to thread all three holes for consistent results – should top thread tension need to be adjusted it should be done at the top tension assembly.

3. Thread continues through thread guide **D**, and then down to the **tension assembly** (see Detail 2 below).

NOTE: It is important that the thread is “~~l~~ossed” up between the two tension discs. If the thread is not firmly in place between the two tension discs, the thread rests on the outside of the tension discs (without tension) and looping on fabric or thread nests may occur.

Diagram G

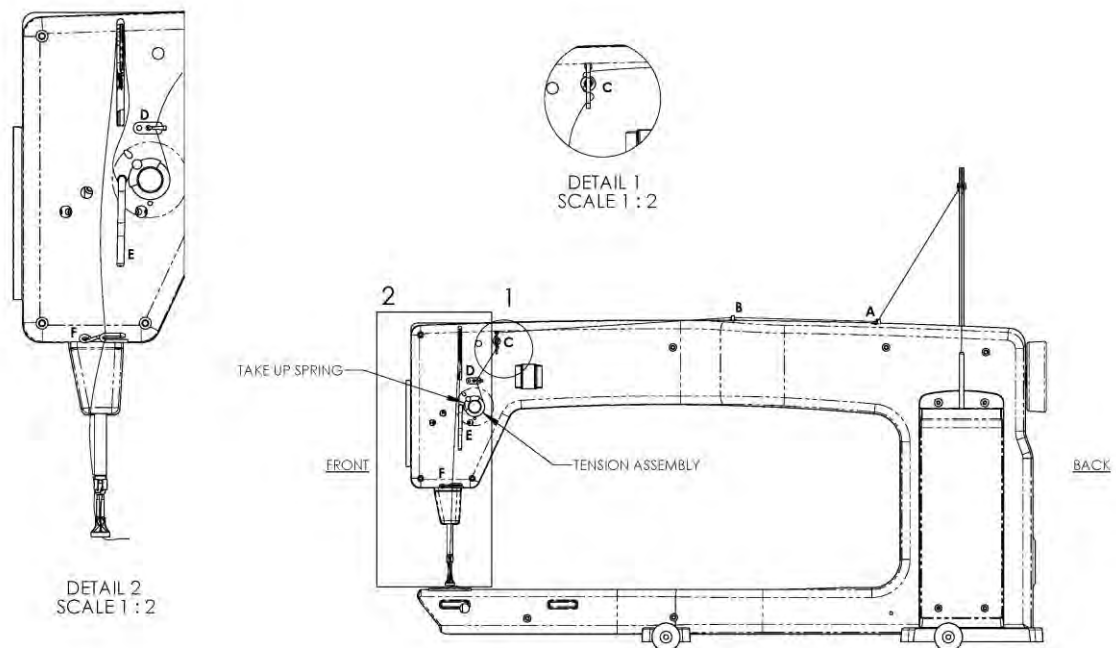

4. Once the thread is in place, be sure that the thread catches on the **take up spring** and then pull it down under the stirrup (thread guide **E**).

5. Bring the thread back up through the **take up lever** from back to front, and then down through thread guide **F**.
6. Pull the thread down to the **needle thread guide** and thread through the hole.
7. Make sure the thread is following the groove down the front of the needle and **threads from front to back**. Be careful that the thread does not twist around the needle.

Note: To test that the machine is threaded correctly and the tension is correct, carefully pull the needle thread - taking care to not bend the needle. It should pull smoothly with light to medium tension.

Important notes: The HQ Fusion™ quilting machine does not have a presser foot lever or top tension release like a home sewing machine. On a home sewing machine the top tension is released when the presser foot is raised allowing the thread to come freely out of the machine. When a home machine is threaded the tension discs are released and open for the thread to easily fall between the tension discs. This is not the case with the HQ Fusion™ quilting machine where the top tension is always tight and the tension discs are never open. Therefore, the thread must be pulled up or “~~loosened~~” between the tension discs or it will stay outside the discs and float without tension, causing serious tension problems and/or thread nests. It is also possible to bend the needle while it is threaded if care is not taken while moving the machine around the quilt because the top tension is never released.

Optional Horizontal Spool Holder

1. An optional horizontal spool holder is available for metallic and specialty threads wound on a spool (not a cone).
2. The horizontal spool holder mounts on the laser stylus guide post on the top of the machine (see Photo 8).
3. When using threads on the Horizontal Spool Holder, skip thread guides A and B. Thread the top hole only of the three-hole thread guide C, back to front.
4. Continue threading the machine as described in steps 3 through 7 above.



Photo 8

Bobbin and Thread Tension Adjustments

Inserting the Bobbin

1. Place the bobbin in the bobbin case so that the thread pulls off clockwise when viewing the open side (Photo 9).
2. Slide the thread through the slot and under the tension spring leaving 5-6 inches of thread hanging loose (Photos 10 and 11).
3. Do not lift the lever on bobbin case. Fit the bobbin case onto the hook spindle in the machine. Rotate the casing until the open throat keys into the alignment notch in the middle of the hook. Push the casing in until it stops in place. Push inward until it clicks (see Photo 12).

Note: It is not suggested that the lever on the bobbin case be used for this installation. The latch lever should be used only for removal of the bobbin case.

4. Turn off the power switch while inserting the bobbin case or anytime the hands are near the needle area.

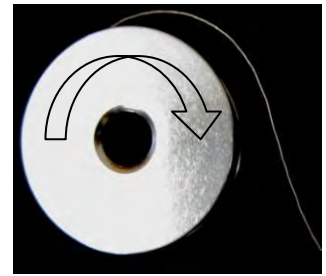

Photo 9



Photo 10



Photo 11

Drawing up the Bobbin Thread to the Top of the Quilt

1. After the machine is threaded, locate needle up/needle down button on the left handle.
2. While firmly holding the tail of the needle thread, press the needle up/down button with free hand bringing the needle back to the up position.
3. Pull the machine 3-4 inches away while holding the needle thread.
4. Bobbin thread will pull up through to the top allowing you to grasp the loop and pull it to the desired length.



Photo 12

Bobbin Tension

The bobbin tension is the foundation tension for the entire machine. To test that bobbin tension is correct, hold the bobbin case in the palm of your hand with the open end facing up - wrap the thread

around your index finger and while pulling up on the thread and wiggling the finger front to back (not up and down which is not consistent), the bobbin case should lift up on its side, but NOT lift out of your hand. If it will not lift up onto its side, it is too loose and if it lifts out of your hand, it is too tight. The small screw in the center of the tension spring is where the adjustment is made (see Photo 13). Turn clockwise to tighten and counterclockwise to loosen the bobbin case tension. Check your bobbin tension every time a new bobbin is inserted.

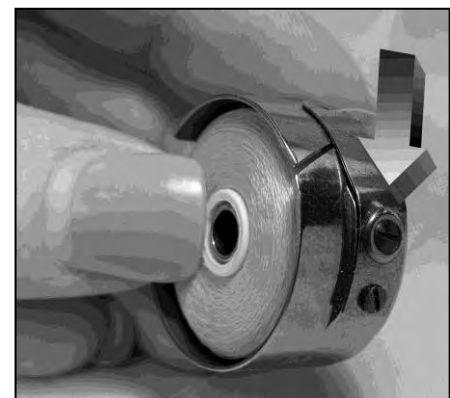

Photo 13

Top Tension

Puckering, gathers and thread breakage occur when the top tension is too tight. Loops and thread nests occur on the back when the top thread tension is too loose. Tension may need to be adjusted depending on the fabric, thread or batting you are using on each project.

Important: Top tension should be adjusted after the bobbin case foundation tension adjustment is made.

To adjust the top tension tighter, turn the tension knob clockwise. To loosen the tension, turn the tension knob counter-clockwise. If the bobbin case tension is adjusted a degree on the screw the top tension may need to be adjusted a $\frac{1}{4}$ to $\frac{1}{2}$ turn to compensate or balance the tension.

Note: Before adjusting your top tension remember to floss or pull the top thread up into the tension discs or it will float outside the discs providing little or no top tension. This could cause significant tension or nesting problems on the bottom side of the quilt.

Consistently using the same thread will reduce your tension issues. If you use multiple brands, weights, types, colors, qualities, and mixes of threads, many tension variables will be created and more tension adjustments will be required. Dark threads will be heavier (because of dye) than light threads of the same weight, type and brand also affecting tension settings. The more consistent one is, the fewer variables will be involved.

Maintenance

Cleaning and Lubricating the Machine

Only use light sewing machine oil in the HQ Fusion™. Internal oiling is not necessary on the HQ Fusion™ except when the machine is taken to a service technician for routine maintenance and cleaning. **The bobbin basket assembly, however, needs regular lubricating.** Failure to keep the bobbin assembly lubricated can cause severe damage to the machine. To lubricate, turn off the machine. Clean around the bobbin assembly with a soft brush to remove lint.

Put a very small drop of oil on the hook in the bobbin assembly (see Photo 14). (Remove bobbin and case before oiling). The frequency depends upon the usage of the machine. Lubricating is recommended before running the machine if it has not been used regularly, or every other bobbin change if used frequently. After oiling, always sew a scrap piece as oil may cling to thread. Over oiling can cause excess dripping from the bobbin assembly. Lack of lubricant may be noticed by a change in the sound of the machine and will affect stitch quality.

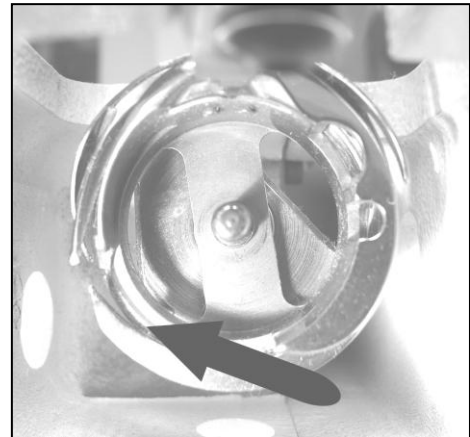

Photo 14

Using the Displays on the Handles

Cleaning the Touch Screen Display

Never use any chemicals to clean your display, as this may adversely affect the touch-screen response. Use a damp soft rag and gently wipe the display to remove any marks from the display. If necessary, diluted mild dishwasher soap may be used on the soft rag to remove grease marks.

Machine and Handlebar Menus

Note: Review the Handi Quilter “Welcome” DVD for interactive instruction on the HQ Fusion™ menu functions.

The HQ Fusion™ has touch-screen displays on the front and rear handles. Settings may be changed at either of these locations.

Manual Mode Screen

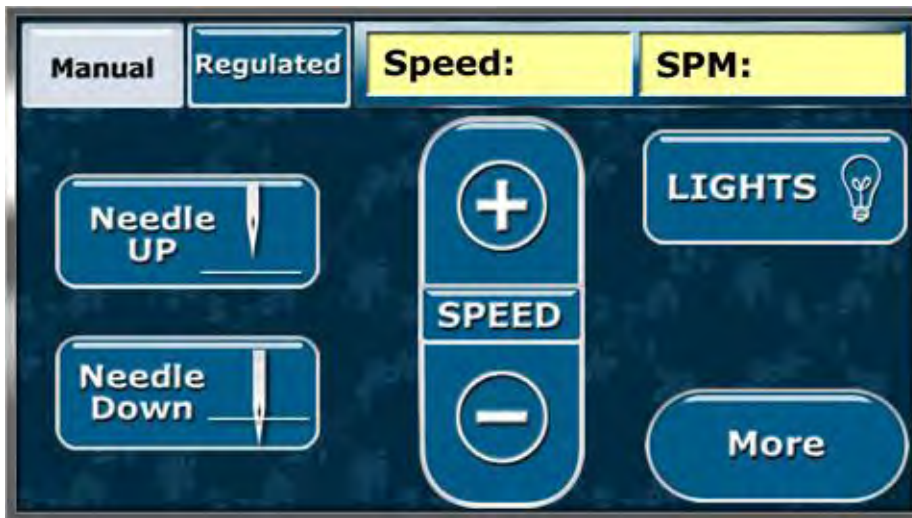

Button Functions:



Pressing the “Regulated” button while in the Manual Mode Screen will toggle to the Regulated Mode Screen. The white button indicates which mode the system is currently in. Different options are available depending upon which mode the system is in.



When in “Needle Up” mode (the button is white when activated), the needle ends in the “Up” position upon pressing the “Stop” button on the handles. This button does not move the needle, but simply determines the final needle position after the machine has been stopped.



When in “Needle Down” mode (the button is white when activated), the needle ends in the “Down” position upon pressing the “Stop” button on the handles. Again, this button does not move the needle, but sets the final resting position of the needle after “Stop” is pressed.



Pressing the Speed “+” will increase the manual mode motor speed and pressing the Speed “-” button will decrease the manual mode motor speed. This has the same effect as pressing the “+” and “-” buttons on the actual handles. The speed range is between 5% and 100%, or between 110 and 2200 stitches per minute (SPM). The percent speed as well as the stitches per minute are displayed in the yellow boxes at the top of the screen.



The “Lights” button will take you to a screen that will allow you to adjust the color and intensity of your front handlebar LED lighting.



The “More” button will access the “More” menu screen, which allows access to such tools as the video player, audio player, calculator and system information.

Regulated Mode Screen

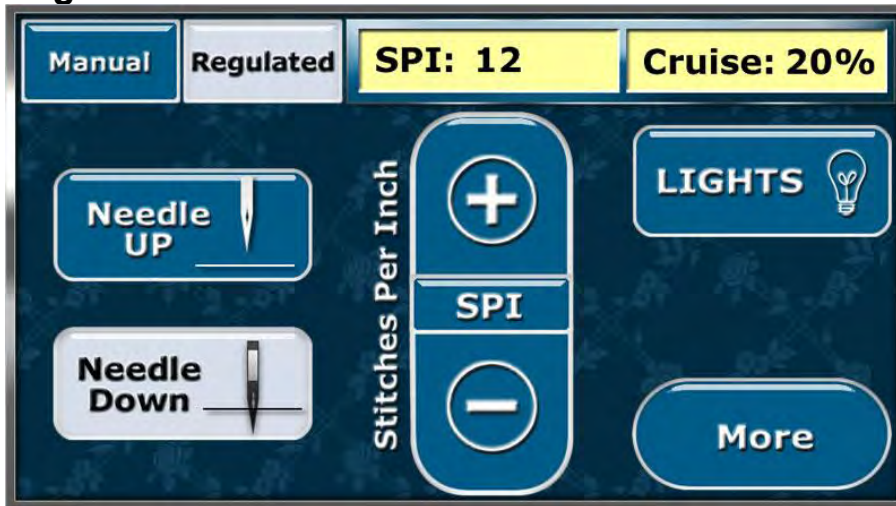

Button Functions



Pressing the “+” or “-” buttons will increase or decrease the stitches per inch (SPI) setting and is reflected in the yellow indicator box at the top of the screen. This value can be adjusted between 4 and 24 stitches per inch.

The “Cruise” indicator box at the top of the screen indicates whether the machine is in “Cruise” regulation mode or in “Precision” regulation mode. Cruise mode can be set from within the “More” screen between 5 and 100% or “Precision.” To set to “Precision” mode, press the “-” button until the word “Precision” appears in the box.

For information on other buttons on this screen, please refer back to the Manual Mode screen.

“More” Screen



Button Functions



Accesses the system's video player feature. Videos must be saved onto an SD memory card and inserted into the memory card slot on the right-hand side of the touch screen device. Videos should be in **MPEG-1, MP4, WMV, AVI, ASF, or 3GP** format.



Audio files may be played using the Audio feature. Audio files must be stored onto an SD memory card and inserted into the memory card slot on the right-hand side of the touch screen device. Audio files should be in **MP3, WMA, or WAV** format.

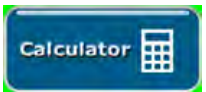

An on-screen calculator may be accessed from the “More” screen.



—System will display information about the Fusion electronics board and firmware versions as well as serial number and Lifetime and Project counters. The System screen also allows access to the touch screen calibration program and some diagnostics tests.

The “Cruise Speed” may be adjusted here using the “+” and “—” buttons to speeds between 5% and 100%. If you adjust the speed lower than 5%, the “Cruise” regulation function will be turned off.



Press the  button to return to either the “Regulated” or “Manual” main menu screen.

Lights Screen

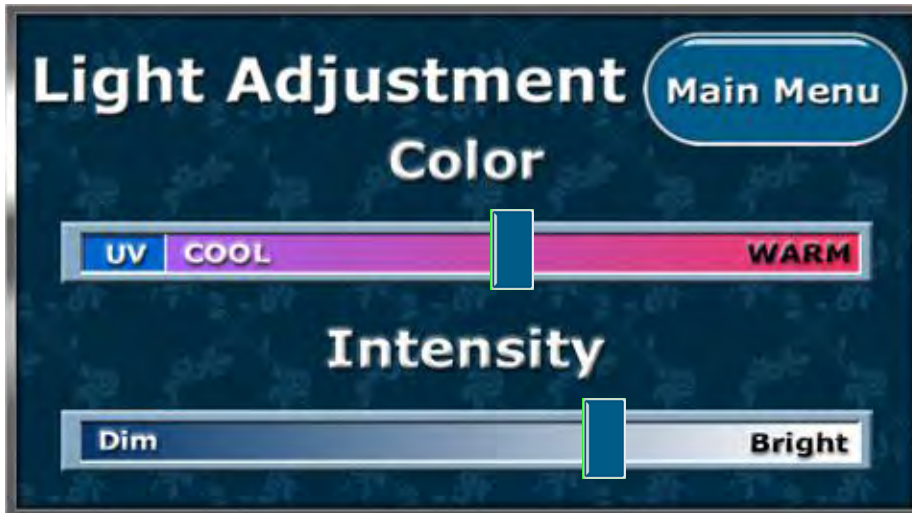

Color

Adjust the color of the lighting by dragging the button left or right across the slide bar. Cool lighting will appear more blue while warm lighting will appear more red. If you slide the bar to the extreme left, this will turn on the UV lights and turn the white lights off.

UV

CAUTION!!! Looking directly into the UV lights or prolonged exposure to the UV lights can damage your eyes. Limit the use of the UV lights to avoid permanent eye damage. Use of UV A/B blocking sunglasses will reduce eye strain and limit the effects of prolonged exposure to UV lighting.

CAUTION!!! Users who have had cataract surgery should not use the UV lighting unless they have had UV A/B blocking replacement lenses implanted as part of the surgery

UV lighting can be very useful when trying to view white thread or white chalk on white fabric. The best contrast is achieved when viewed in a dark or dimly lit room. Although Handi Quilter has chosen to use UV lights which emit a light wavelength at the lowest end of the UV spectrum to minimize eye strain and damage, constant or direct exposure to any UV lighting can cause eye strain and may lead to permanent eye damage. Care should be taken to avoid looking directly at the UV lights (which emit a violet colored light) and the UV lights should only be used when other lighting sources cannot produce the visual contrast necessary to achieve accurate quilting.

Intensity

Adjust the light intensity by sliding the button left or right across the slide bar to achieve the desired lighting intensity.

Press the  button to return to the —Regulated” or —Manual” menu screen.

System Information



Information contained in the yellow boxes identifies the electronics board revision number as well as the firmware revision number of the HQ Fusion. The serial number of the HQ Fusion is listed at the bottom, just under the Lifetime and Project stitch counters. The Project Counter can be reset to keep track of the number of stitches

taken during a given project. To reset this counter, press the pink  button just to the left of the “Project Count” box.

Button Functions



To calibrate the touch screen, press the “Calibrate” button in the System Information screen. A new screen will appear which will ask you to touch the center of a cross-hairs with your stylus. You will be asked to touch several different locations on the screen with your stylus. To complete calibration, you will be asked to tap the screen to keep the changes or to wait for 30 seconds to keep your current calibration settings.



On-screen diagnostics may be accessed to help identify certain problems with the HQ Fusion. Pressing the “Diagnostics” button will call up a screen that contains several diagnostics test programs you may choose from.



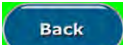

Press the “Main Menu” button to return to the “Regulated” or “Manual” menu screen or the  button to return to the “More” menu screen.

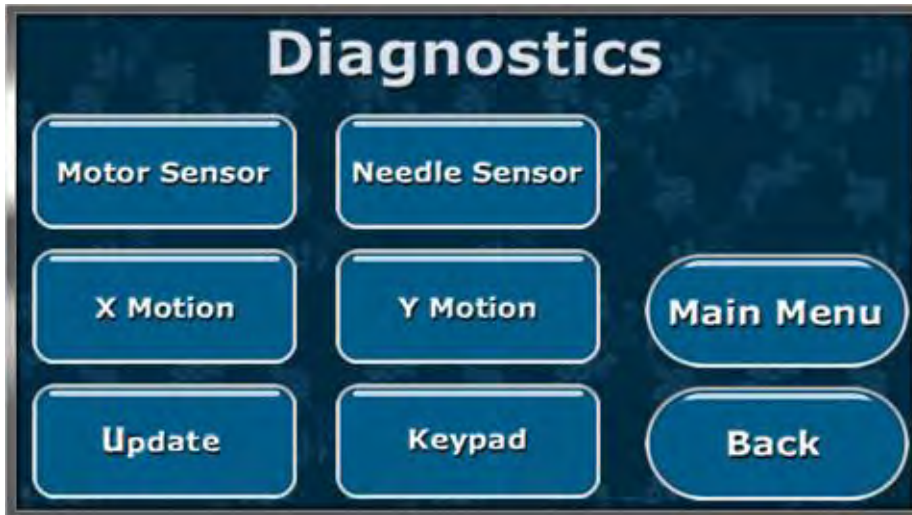
Diagnostics Screen



Press any of the diagnostics test buttons to perform that particular diagnostic test.

Press the  button to return to the —Regulated” or —Manual” menu screen or the  button to return to the —System Information” menu screen.

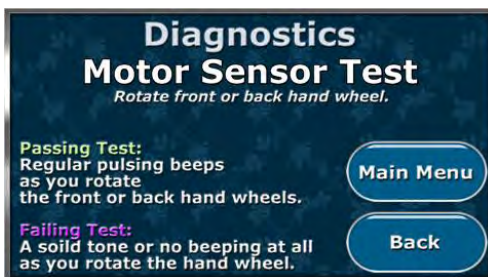

The **Motor Sensor test** can help you determine whether they may be a problem with the HQ Fusion motor. Rotating the front or back hand wheel should result in a pulsing audible —beep.” If you get a constant solid —beep” or no —beep” at all, this indicates a failed test and the machine should be inspected by a qualified Handi Quilter repair technician.

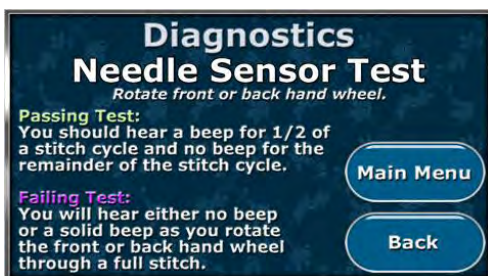

The **Needle Sensor test** will indicate whether the needle position sensor is functioning properly. Rotating the front or back handwheel should result in a —beep” for half of a stitch cycle followed by no —beep” for the other half. If you hear a constant beep or no beep at all for a full 360° rotation of the hand wheel, this indicates a failed test and the machine should be inspected by a qualified Handi Quilter repair technician.

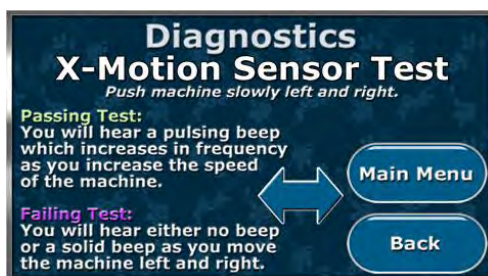

Use the **X Motion Sensor test** to verify functionality of the “X” stitch regulator encoder (the encoder mounted at the rear of the carriage). As you move the carriage left and right you should hear a pulsing —beep” that pulses faster as you move faster. A solid beep, no beep, or periods of irregular beeping (with constant motion) indicate a problem with the “X” encoder. This could be an unplugged or damaged cable, a stitch regulator wheel that is not rotating, or possibly an issue with the main control board.

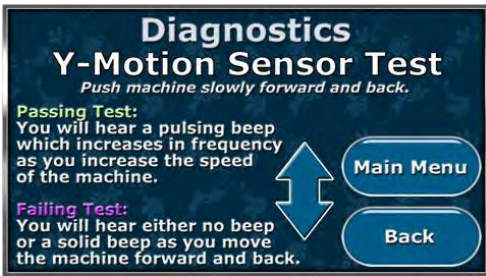

Use the **Y Motion Sensor test** to verify functionality of the “Y” stitch regulator encoder (the encoder mounted to the rear power pod side machine wheel). As you move the carriage toward and away from you, you should hear a pulsing “beep” that pulses faster as you move faster. A solid beep, no beep, or periods of irregular beeping (with constant motion) indicate a problem with the “Y” encoder. This could be an unplugged or damaged cable, a stitch regulator wheel that is not rotating, or possibly an issue with the main control board.

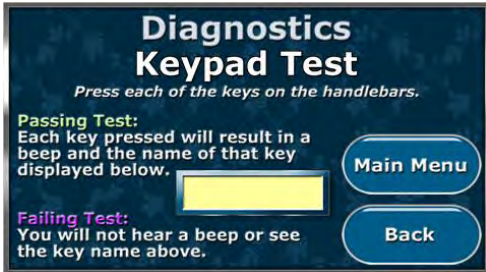

The **Keypad test** allows the user to press any of the four keys on the front or back handles to verify that the HQ Fusion is reading the buttons as they are pressed. When a key is pressed a “beep” will be heard and the name of the key that is pressed will appear in the yellow box.



Updates



Handi Quilter may release updates on occasion that can be downloaded from the Internet and saved to the included SD memory card. The memory card should then be plugged into the slot on the right-hand side of the touch screen display as shown. Press it all the way in until it clicks into position and does not spring back out. It may be necessary to use the stylus to assist you in pushing the card in all the way.



With the update file saved onto the SD card and SD card in place in the touch screen monitor, press the  button. A message will appear telling you not to remove the SD card while the update is in process. Press “OK” and the update will begin. If the system is unable to locate a proper update file on the SD card then an error message will appear and you can cancel the update.



From any of the Diagnostics screens, press the  button to return to the “Regulated” or “Manual” menu screen or the  button to return to the “Diagnostics” menu screen.

Using the Handle Buttons

The following functions take effect by pressing and then quickly releasing the button:

Selection Type	Function
Needle Up/Needle Down	Allows the user to manually move the needle one half stitch or one full stitch at a time. The machine will make slow stitches when Needle Up/Down is pressed and held.
Start/Stop	Starts and stops the machine.
Speed Up	By pushing the plus sign in Manual Mode, the speed of the machine will gradually increase. The % of machine needle speed is displayed on the touch screen monitor, ranging from 5-100%. In Regulated mode, the stitches per inch will increase, ranging from 4-22 SPI.
Speed Down	By pushing the minus sign in Manual Mode, the speed of the machine will gradually decrease. The % of machine needle speed is displayed on the touch screen monitor, ranging from 5-100%. In Regulated mode, the stitches per inch will decrease, ranging from 4-22 SPI.

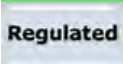
HQ Stitch Regulator Operation

To use regulation mode, the  button must be active (white). If it is blue, simply press the  button on the touch screen to switch from —Manual” mode to —Regulated” mode.

Important Notes: Please read before operating

Starting and Stopping the Machine

You can stop the machine at any time by pushing the **START/STOP** key.

In **Cruise Regulation** mode, if you don't move the machine after 3 or 4 stitches, the machine will stop and position the needle.

In **Precision Regulation** mode, the needle stops when you stop moving the machine and will begin stitching again when you start moving the machine again. Press the **START/STOP** key in Precision Regulation mode to stop the needle completely and cause the needle to position itself in the needle Up or Down position.

When in Precision Regulation mode, there is a red or green light next to the word —Precision” in the top right-hand corner of the screen. When you press the —Start” button, the light will turn green, indicating that as soon as you start moving the machine, the machine will begin stitching. When you press the —Stop” button, the light will turn red, indicating that the needle will not move when you move the machine.

NOTE: Always make sure the light is RED when you are in Precision Regulation mode prior to working with your hands near the needle (changing the needle, replacing the bobbin, etc.) to avoid unwanted stitching in your quilt or your hands!

If you leave the HQ Fusion™ in Precision Regulation mode with the Green Light on and do not move the machine for two minutes, the system will “time-out” and a message box will appear, indicating that the system has stopped and you will need to press the —Start” button again to resume quilting.

Watch Your Speed

It is important to not move the machine too fast since this will result in an **OVERSPEED CONDITION**, during which, the machine drops out of regulation until you slow your motions to below 100% of motor capacity.

You can return to **MANUAL** mode from by pushing the **MANUAL** button at the top of the touch screen display.

To Begin Quilting

Thread Requirements

Choose high quality threads for your valuable heirloom quilts. Most machine quilting threads on the market today are acceptable for use with the HQ Fusion. Threads may weaken with time, so keep your thread collection fresh.

Needle Requirements

For general quilting, a size 16/100 needle will accommodate most threads and fabrics. Heavier threads, such as topstitch and some decorative threads, require a larger needle such as 18/110 or 20/120. Lofty batts and heavier fabrics such as denim, canvas or densely woven fabric may also require a larger needle.

To Prepare for Quilting

With any quilting machine, it is important to understand the basics of free motion quilting. The HQ Fusion™ Quilting Machine does not have feed dogs like domestic machines; therefore, the fabric does not automatically feed under the hopping foot. The operator should synchronize the speed as well as the movement of the machine to get an even, consistent stitch.

In order to become comfortable with the free motion of the HQ Fusion™, users can begin with a few —beginner” techniques.

In Manual Mode: Set the machine at a medium speed and begin moving it until you become accustomed to the resistance. By moving the machine faster, the stitches begin to elongate. The stitch speed can either be increased or the machine can be moved slower to get the stitches back to the desired length. By moving the machine slower, the stitches get shorter and can build up on top of each other, breaking the thread or making it extremely difficult to unpick. The stitch speed can be decreased, while maintaining a constant motion with the machine to bring the stitches back to the desired length.

In Stitch Regulator Mode: Set the machine to desired stitch length. Begin moving the machine to become accustomed to the resistance. The machine motor will slow down or speed up to maintain a consistent stitch length according to how quickly or slowly you move the machine. Moving the machine too fast or in radical or jerky movements will defeat the stitch regulator function.

In MANUAL or CRUISE REGULATION Mode, when pressing START on the front or rear handle bars, make certain to begin moving the machine immediately. If the needle stitches in one place too long, the stitches build up on top of each other causing a build up of thread or thread breakage. When bringing the machine to a complete stop press the STOP button at the same moment the machine stops moving. If the machine is still moving when the STOP button is pressed, it can cause deflection in the needle, possibly causing it to bend or break. In PRECISION REGULATION mode, the needle will not begin moving when you press the START button until you begin moving the machine.

When quilting, relax your hands and maintain a light touch on the handlebars. Gripping the handlebars too tightly may cause body tension resulting in poor quilting quality. The HQ Fusion™, combined with the Fusion Frame system will give you a smooth even glide.

Using the Memory Card

Identifying the Parts

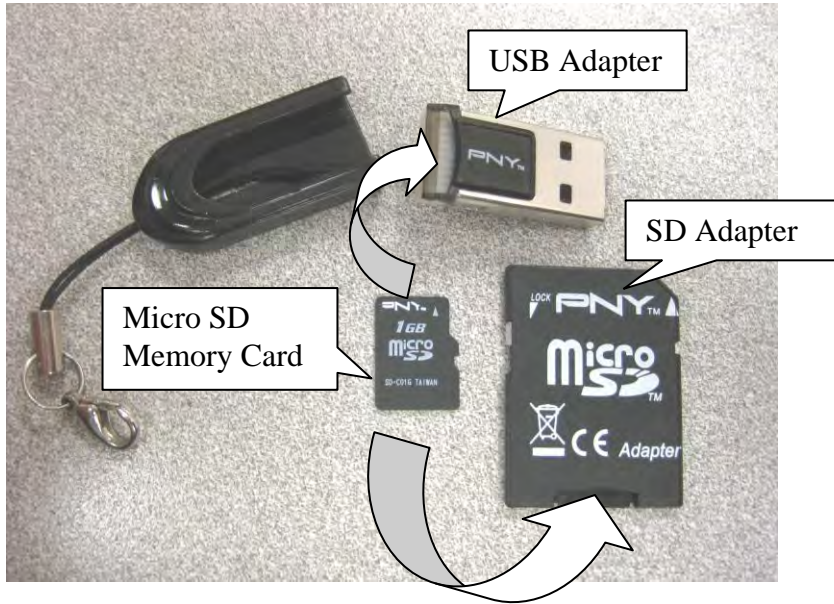

The smallest component (the Micro SD card) is the actual memory device. It can be plugged into the USB adapter to be used on a home computer or the SD adapter to be plugged into the Pro-Stitcher touch screen display.

How to Use the Memory Card

Files (including updates from Handi Quilter, audio files and video files) may be added to your memory card from your home computer by using the USB adapter. To remove the USB adapter from the plastic carrying case, use the string to pull the USB adapter out of the case enough to grasp the USB end with your fingers and remove it the rest of the way. Insert the Micro SD memory card into the USB adapter as shown above. Plug the USB adapter into your home computer and locate the memory card on your computer's operating system. Copy files to the card according to your computer's requirements.

After saving files to the memory card, remove the Micro SD card from the USB adapter and plug it into the SD adapter. Insert the SD card into the right-hand side of the touch-screen device, making sure to push it in until it "clicks" into position and does not spring back out. It may be necessary to use the stylus to aid in pressing the SD card into position.





The stylus is stored on the bottom, right-hand corner of the touch screen display. For easiest access to the stylus, tilt the touch-screen display until it is completely flat (screen facing upward).

You may then access audio or video files using the Audio and Video players found within the **More** screen. If you are attempting to load an update for the display from the card, you will be required to re-boot your system in order for the update to begin. Updates for the rest of the system can be loaded using the **Update** button.

Troubleshooting

Stitches are Skipping	Corrective Measure
<ul style="list-style-type: none"> ▶ The needle is damaged, dull, bent, or installed improperly ▶ Incorrect needle size ▶ The needle has not been positioned properly ▶ Fabric is too tight on the frame ▶ Thread tension too tight ▶ Improper threading 	<ul style="list-style-type: none"> ▶ Replace the needle often, normally once or twice per day for continuous quilting or at least once per quilt. Use HQ Fusion™ recommended needles. ▶ Always change the needle if the needle has struck any hard object such as a straight pin, etc. The tip of the needle can become damaged or burred, resulting in fabric damage as well as skipped stitches, thread breakage or shredding. ▶ Always change the needle if it has been hit, bumped or pulled off center while maneuvering the machine about the quilt. A slightly bent needle can be a major cause of skipped stitches. ▶ Check for the proper size of needle for the work and thread being applied to the quilting operation. Some battings and fabrics used in quilting may constrict or impede the thread passing through the front groove of the needle. This diminishes the loop lift required for stitch formation. Typically, a larger needle will solve the problem; however, it has been found that certain smaller sizes of needles as well as the use of ball pointed needles solve some specific problems. ▶ Position the needle properly to the needle bar. Inspect the position of the needle to make sure the needle is at the 6 o'clock position (see Photo 16)—If you stand directly in front of the needle (facing the bobbin case side of the machine), you will see the entire needle eye directly facing you. This is 6 o'clock position. Make sure (1) the needle is installed all the way into the needle bar to the needle stop hole in the needle bar, (2) the long groove in the needle is toward the front (bobbin case side), and (3) the scarf/scooped out part of the needle is toward the back handwheel. The needle can sometimes be rotated to 5 o'clock (slightly right) or 7 o'clock (slightly left) in order to adjust for a more positive thread loop pickup by the hook point. ▶ Loosen pole tension on the frame. Fabric that is rolled too tight causes the fibers to separate. This reduces the needle friction on the thread resulting in a smaller thread loop. ▶ Loosen top tension. Re-check top and bobbin tension (see pages 12-13). ▶ Inspect that the thread take-up lever, thread stirrup or tension spring are all threaded correctly.
<p>The Needle Breaks</p> <ul style="list-style-type: none"> ▶ The needle is bent or not installed properly ▶ The needle hits the throat plate 	<p>Corrective Measure</p> <ul style="list-style-type: none"> ▶ Replace or correctly change the needle. Make sure that the needle is pushed up into the needle bar clamp until it can go no farther (visually check that it is up to the top of the stop/sight hole above the needle bar clamp screw). Failure to do so can cause damage in the bobbin area and throat plate. ▶ Correctly position the needle, throat plate or hopping foot. Replace with a new needle.
<p>Stitches are Puckered</p> <ul style="list-style-type: none"> ▶ The hopping foot applies too much pressure to the material ▶ The tension is not balanced ▶ Needle too large for material 	<p>Corrective Measure</p> <ul style="list-style-type: none"> ▶ Decrease the pressure on the hopping foot by loosening the nut at the base of the hopping foot shaft. Adjust to the proper height. Note: When tightening the nut on the hopping foot shaft, be careful not to tighten so tight that it rotates the bar. ▶ Balance the tension of the needle thread after ensuring the bobbin tension is adjusted correctly (see page 12). ▶ Replace the needle with a size better suited for the fabric.
<p>Stitch Quality is Poor</p> <ul style="list-style-type: none"> ▶ The tension is not balanced ▶ Bobbin case is damaged, corroded, dirty, etc ▶ Moving the machine too fast for needle speed selected 	<p>Corrective Measure</p> <ul style="list-style-type: none"> ▶ Adjust the tension of the needle thread after ensuring the bobbin tension is adjusted correctly (see page 12). ▶ Since thread slides over the surface of the bobbin case at a high speed, make sure the case is free of any lint or foreign matter that could impede thread passage through the machine. ▶ Synchronize machine movement and needle speed to get roughly 8-10 stitches per inch. Elongated stitches are an indication of moving the machine too fast for the current speed.

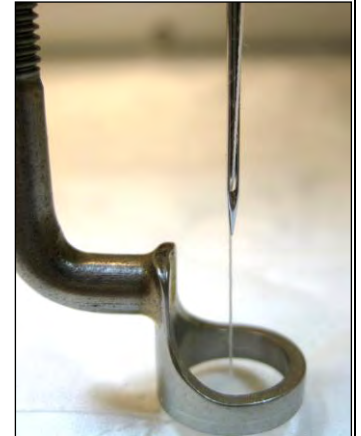

Photo 16

Tension is Poor	Corrective Measure
<ul style="list-style-type: none"> ▶ “Fuzz” caught under the tension spring in the bobbin 	<ul style="list-style-type: none"> ▶ If using short staple threads, inexpensive or industrial threads or coated threads, lint and other material will build up under the tension leaf spring and begin to lift the spring, reducing the spring’s ability to compress against the thread. By inserting a needle under the spring and clearing out the lint, the bobbin tension will return fairly close to its preset tension.
Hand Wheel Won’t Rotate	Corrective Measure
<ul style="list-style-type: none"> ▶ Thread is entangled and caught in the hook 	<ul style="list-style-type: none"> ▶ Turn off the machine and unplug the machine from the electrical outlet. Lubricate the hook, strongly turn the hand wheel clockwise and if necessary counterclockwise several times, and then remove the thread caught in the hook.
Thread Nests Under Quilt	Corrective Measure
<ul style="list-style-type: none"> ▶ Not enough tension on top thread 	<ul style="list-style-type: none"> ▶ Check that the machine is threaded correctly. Make certain that the thread is flossed snugly in place between the two tension discs. If machine is threaded correctly, tighten top tension by rotating the tension knob clockwise.
<ul style="list-style-type: none"> ▶ Improper threading 	<ul style="list-style-type: none"> ▶ Refer to threading diagram and threading instructions (page 10).
Hard to Guide Machine	Corrective Measure
<ul style="list-style-type: none"> ▶ Carriage wheels not centered on track 	<ul style="list-style-type: none"> ▶ Center the carriage wheels on top of the continuous track. Check that the machine carriage has not “jumped” track.
<ul style="list-style-type: none"> ▶ Thread caught in wheels 	<ul style="list-style-type: none"> ▶ Remove all thread or debris in wheels. Check that the tracks are free of lint and threads.
Motor Fails to Run	Corrective Measure
<ul style="list-style-type: none"> ▶ On/Off switch turned off 	<ul style="list-style-type: none"> ▶ Turn the machine on by using the switch on the back power pod.
<ul style="list-style-type: none"> ▶ Machine not receiving power 	<ul style="list-style-type: none"> ▶ Check that the power connector is securely plugged into the back of the machine and the three-prong end is plugged into the power source.
Uneven Quilt Design	Corrective Measure
<ul style="list-style-type: none"> ▶ Take-up rollers may be bowed or bent 	<ul style="list-style-type: none"> ▶ Make certain the fabric is not rolled too tight, causing the poles to bow. Check that poles are inserted completely together with the push pin engaged so bowing won’t occur.
<ul style="list-style-type: none"> ▶ Leaders are stretched/worn 	<ul style="list-style-type: none"> ▶ If fabric is beginning to stretch or fray, contact Handi Quilter for replacement leaders.
Needle Thread Breaks	Corrective Measure
<ul style="list-style-type: none"> ▶ Thread cones/spools are poor quality or may have severe twisting or thread rot 	<ul style="list-style-type: none"> ▶ Look for severe twisting of threads when approximately 12 to 15 inches has been pulled off, with the ends pinched together. Cotton threads are particularly susceptible to dry rot or wet rot which makes thread brittle. Do not use poor quality thread, or thread that is rotted or brittle.
<ul style="list-style-type: none"> ▶ Top and bobbin tensions not balanced 	<ul style="list-style-type: none"> ▶ Check thread tension in top and bobbin for proper balance. See pages????.
<ul style="list-style-type: none"> ▶ The machine head has been threaded incorrectly or thread spools are not positioned correctly 	<ul style="list-style-type: none"> ▶ Check that the machine is threaded correctly. ▶ Inspect for accidental double wrapping of thread on thread guides. ▶ Inspect the thread mast, making sure the eyelets of the mast are directly over the spools. ▶ Inspect the vertical positioning of the thread cones. Tipped cones can dramatically affect thread tension and can cause breakage.
<ul style="list-style-type: none"> ▶ Particles in tension discs 	<ul style="list-style-type: none"> ▶ Inspect for particles and remove any fuzz or debris.
<ul style="list-style-type: none"> ▶ Bobbin rotation is not smooth 	<ul style="list-style-type: none"> ▶ Change the bobbin. The slightest hesitation of the bobbin rotation can be the cause of dramatic tension change and thread breakage.
<ul style="list-style-type: none"> ▶ Needle is burred, bent or dull, or installed incorrectly 	<ul style="list-style-type: none"> ▶ Change the needle at least once per quilt. Make sure the needle is installed to the top of the stop hole in the needle bar.
<ul style="list-style-type: none"> ▶ Needle not suited for thread 	<ul style="list-style-type: none"> ▶ Replace the needle to one better suited for the thread. Use the proper size needle.
<ul style="list-style-type: none"> ▶ Hesitating too long at one point in pattern 	<ul style="list-style-type: none"> ▶ Move more quickly so stitches don’t overlap or build up. When starting the machine, begin moving immediately. Sewing in one place too long will cause the thread to break.
<ul style="list-style-type: none"> ▶ Improper needle/hook relationship 	<ul style="list-style-type: none"> ▶ Timing of the machine is improper. Consult a repair technician.
<ul style="list-style-type: none"> ▶ Damage or —Burrat needle hole of throat plate or other thread handling part 	<ul style="list-style-type: none"> ▶ If thread is shredding at the throat plate, check for burrs or jagged edges. Gently rub with metal cloth to remove the sharp edge. Consult a repair technician to polish any hard to reach or delicate areas, or if the burr is inside the throat.

<ul style="list-style-type: none"> ▶ Wrong type of needle ▶ Other possible problems 	<ul style="list-style-type: none"> ▶ Use needles recommended by Handi Quilter. Using the wrong needle with a smaller shank diameter causes many problems. For example, a system 1738 or 287WH needle with a shank diameter of 1.64mm will fit loosely into the needle bar clamp. This condition allows the needles to fit into the clamp at an angle which may cause problems including skipped stitches and the needle positioned too far away from the hook point. ▶ Needle too close to hook, causing friction and possible collision of hook point and needle (broken thread). ▶ Needle plate damage ▶ Hook damage ▶ Broken needles or damaged needle bar clamp
Unresponsive Touch Screen	Corrective Measure
<ul style="list-style-type: none"> ▶ Touch screen calibration needed 	<ul style="list-style-type: none"> ▶ From either the REGULATED or the MANUAL screen, press the MORE button followed by the SYSTEM and then CALIBRATE buttons. Follow the on-screen instructions for re-calibrating the touch screen.
No Visible Display	Corrective Measure
<ul style="list-style-type: none"> ▶ USB cable unplugged ▶ 9-Pin serial cable unplugged 	<ul style="list-style-type: none"> ▶ Locate the small black USB cable that plugs into the left hand side of the touch screen display and connects it to the handlebar circuit board. Make sure both ends are plugged in securely. ▶ Check the short serial cable that connects the handlebar to the casing of the machine and make sure that the connections are secure. Tighten the finger screws if necessary.

* If the troubleshooting above does not eliminate the problem, please consult an authorized HQ Fusion™ representative.



Designed by a Quilter, for Quilters.®

Handi Quilter, Inc
445 N. 700 W.
North Salt Lake, UT 84054
1-877-697-8458
www.handiquilter.com