

# CSB200-883

## User Manual

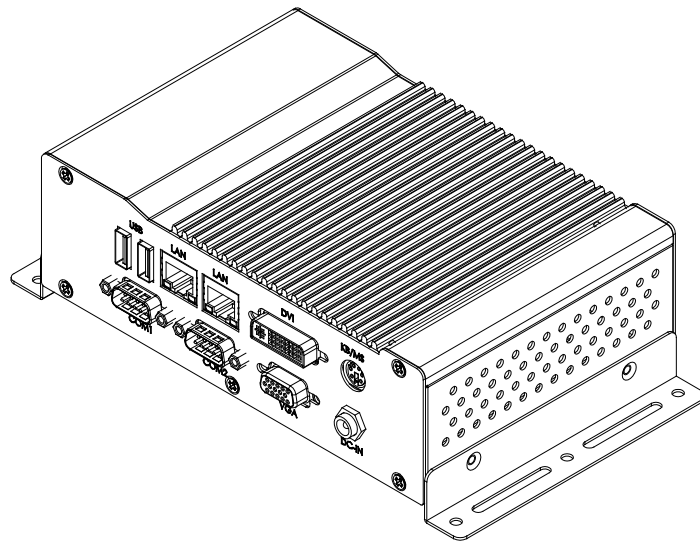

2009 April V1.0

**Copyright © 2008 IBASE Technology INC. All Rights Reserved.**

No part of this manual, including the products and software described in it, may be reproduced, transmitted, transcribed, stored in a retrieval system, or translated into any language in any form or by any means, except documentation kept by the purchaser for backup purposes, without the express written permission of IBASE Technology INC. ("IBASE").

Products and corporate names mentioned in this manual may or may not be registered trademarks or copyrights of their respective companies, and are used for identification purposes only. All trademarks are the property of their respective owners.

Every effort has been made to ensure that the contents of this manual are correct and up to date. However, the manufacturer makes no guarantee regarding the accuracy of its contents, and reserves the right to make changes without prior notice.

## Table of Contents

<b><i>Accessories</i></b> .....	<b>6</b>
<b><i>Components</i></b> .....	<b>7</b>
<b>Front View</b> .....	<b>7</b>
<b>Rear View</b> .....	<b>8</b>
<b><i>Specification</i></b> .....	<b>10</b>
<b><i>Mounting CSB200 to the Wall</i></b> .....	<b>11</b>
<b>Wall mounting requirements</b> .....	<b>11</b>
<b>Selecting the location</b> .....	<b>12</b>
<b><i>Exploded view of the CSB200-883 assembly</i></b> .....	<b>13</b>
<b>Parts description</b> .....	<b>13</b>
<b><i>Driver Installation</i></b> .....	<b>14</b>
<b><i>BIOS Setup</i></b> .....	<b>14</b>

## Safety Information

Your CSB200-883 is designed and tested to meet the latest standards of safety for

information technology equipment. However, to ensure your safety, it is important that you read the following safety instructions.

### ***Setting up your system***

- Read and follow all instructions in the documentation before you operate your system.
- Do not use this product near water.
- Set up the system on a stable surface or secure on wall with the provided rail. Do not secure the system on any unstable plane or without the rail.
- Do not place this product on an unstable cart, stand, or table. The product may fall, causing serious damage to the product.
- Slots and openings on the chassis are for ventilation. Do not block or cover these openings. Make sure you leave plenty of space around the system for ventilation. Never insert objects of any kind into the ventilation openings.
- This system should be operated from the type of power indicated on the marking label. If you are not sure of the type of power available, consult your dealer or local power company.
- Use this product in environments with ambient temperatures between 0°C and 45°C.
- If you use an extension cord, make sure that the total ampere rating of the devices plugged into the extension cord does not exceed its ampere rating.

### ***Care during use***

- Do not walk on the power cord or allow anything to rest on it.
- Do not spill water or any other liquids on your system.
- When the system is turned off, a small amount of electrical current still flows. Always unplug all power, and network cables from the power outlets before cleaning the system.
- If you encounter the following technical problems with the product, unplug the power cord and contact a qualified service technician or your retailer.
  - The power cord or plug is damaged.
  - Liquid has been spilled into the system.
  - The system does not function properly even if you follow the operating instructions.
  - The system was dropped or the cabinet is damaged.



## **Lithium-Ion Battery Warning**

**CAUTION:** Danger of explosion if battery is incorrectly replaced. Replace only with the same or equivalent type recommended by the manufacturer. Dispose of used batteries according to the manufacturer's instructions.

### **NO DISASSEMBLY**

The warranty does not apply to the products that have been disassembled by users

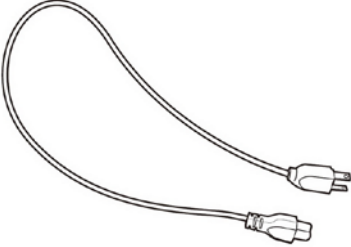
## Accessories

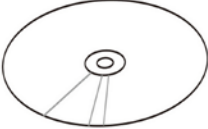
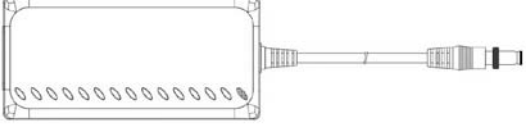
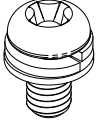
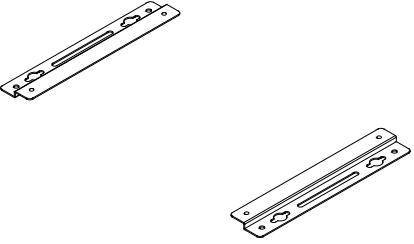
	
a. Power Cord x 1	b. M/B Manual x 1
	
c. Driver CD x 1	d. Power Brick x 1
	
e. Mounting Rail Screw x 4	f. Mounting Rail x 2

# Components

## Front View

Refer to the diagram below to identify the components on this side of the system.

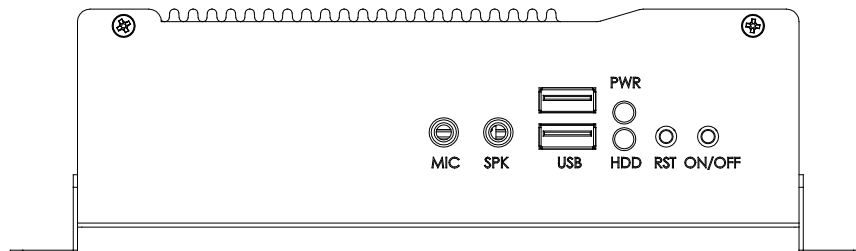

### ON/OFF

The power switch allows powering ON and OFF the system.

### RST

The reset switch allows reset the system.

### HDD

The hard disk LED blinks when data is being written into or read from the hard disk drive.

### PWR

The power LED illuminated when system been power on.

### USB

The USB (Universal Serial Bus) port is compatible with USB devices such as keyboards, mouse devices, cameras, and hard disk drives. USB allows many devices to run simultaneously on a single computer, with some peripheral acting as additional plug-in sites or hubs.

### SPK

The stereo audio jack (3.5mm) is used to connect the system's audio out signal to amplified speakers or headphones.

### MIC

The microphone jack is designed to connect the microphone used for video conferencing, voice narrations, or simple audio recordings.

## Rear View

Refer to the diagram below to identify the components on this side of the system.

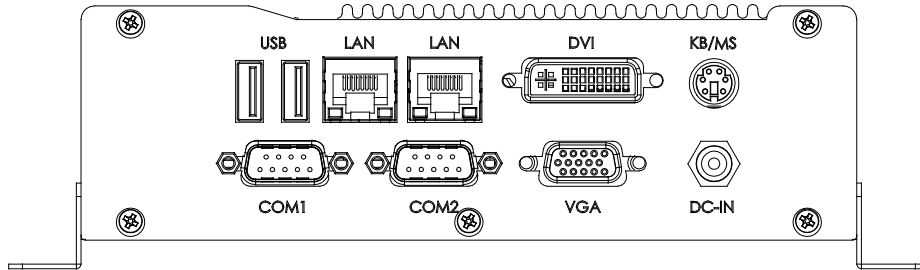

### COM1/2

Communication or serial port one is compatible with RS-232 interface.

### VGA

Video Graphic Array (VGA) port supports a VGA-compatible device such as a monitor or projector. The system default display output port.

### DC-IN

The supplied power adapter converts AC power to DC power for use with this jack. Power supplied through this jack supplies power to the system. To prevent damage to the system, always use the supplied power adapter.

### DVI

The Digital Visual Interface (DVI) port supports a high quality VGA-compatible device such as a monitor or projector to allow viewing on a larger external display.

### LAN

The eight-pin RJ-45 LAN port supports a standard Ethernet cable for connection to a local network.

### USB

The USB (Universal Serial Bus) port is compatible with USB devices such as keyboards, mouse devices, cameras, and hard disk drives. USB allows many devices to run simultaneously on a single computer, with some peripheral acting as additional plug-in sites or hubs.



**KB/MS**

You can connect PS/2 compatible device into this port directly or using Y-cable to have PS/2 mouse port extension.

**MS**

The PS/2 mouse port is use to connect PS/2 mouse.

**KB**

The PS/2 keyboard port is use to connect PS/2 compatible devices such as keyboard, MSR and scanner.

## Specification

<b>System Mainboard</b>	IB883
<b>Construction</b>	Aluminum & Steel
<b>Chassis Color</b>	Black
<b>Storage</b>	2.5" 80GB SATA HDD x 1
<b>Mounting</b>	Desktop or wall mount
<b>Dimensions</b>	172(W) x 52(H) x 113.6(D)mm (6.77" x 2.04" x 4.47")
<b>Power Supply</b>	80W DC adapter
<b>Operating Temperature</b>	0°C ~ 45°C (32°F ~ 113°F)
<b>Storage Temperature</b>	-20°C ~ 80°C
<b>Relative Humidity</b>	10~95% @45°C (non-condensing)
<b>Vibration</b>	HDD: 0.25grm/5~500Hz random operation
<b>Shock</b>	HDD: 15grms peak acceleration (11 msec duration)
<b>RoHS</b>	Available

· This specification is subject to change without prior notice.

## Mounting CSB200 to the Wall

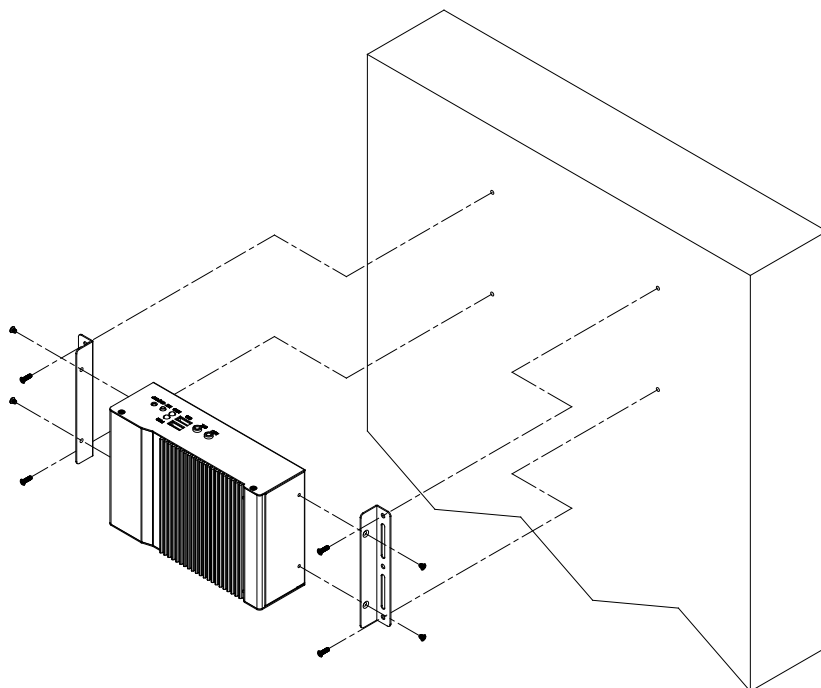

Using attached mounting rail, you can install CSB200 on wood, drywall surface over studs, or a solid concrete or metal plane. Ensure the installer uses at least four M4 length 8mm screws to secure the system on wall. ***Six M4 length 8mm screws are recommended to secure the system on wall.***

Fasteners are not included with the unit, and must be supplied by the installer. The types of fasteners required are dependent on the type of wall construction. Choose fasteners that are rated either "Medium Duty" or "Heavy Duty." To assure proper fastener selection and installation, follow the fastener manufacturer's recommendations.

### Wall mounting requirements

**Note:** Before mounting the system on wall, ensure that you are following all applicable building and electric codes.

When mounting, ensure that you have enough room for power and signal cable routing. And have good ventilation for power adapter. The method of mounting must be able to support weight of the CSB200 plus the suspend weight of all the cables to be attached to the system. Use the following methods for mounting your system:

### **Mounting to hollow walls**

- **Method 1: Wood surface** – A minimum wood thickness – 38mm (1.5in.) by 25.4 cm (10in.) – of high, construction – grade wood is recommended.  
**Note:** This method provides the most reliable attachment of the unit with little risk that the unit will come loose or require ongoing maintenance.
- **Method 2: Drywall walls** - Drywall over wood studs is acceptable.

**Mounting to a solid concrete or brick wall** - Mounts on a flat smooth surface.

### **Selecting the location**

Plan the mounting location thoroughly. Locations such as walkway areas, hallways, and crowded areas are not recommended. Mount the unit to a flat, sturdy, structurally sound column or wall surface.

The best mounting surface is a standard countertop, cabinet, table, or other structure that is minimally the width and length of the unit. This recommendation reduces the risk that someone may accidentally walk into and damage the device. Local laws governing the safety of individuals might require this type of consideration.

## Exploded view of the CSB200-883 assembly

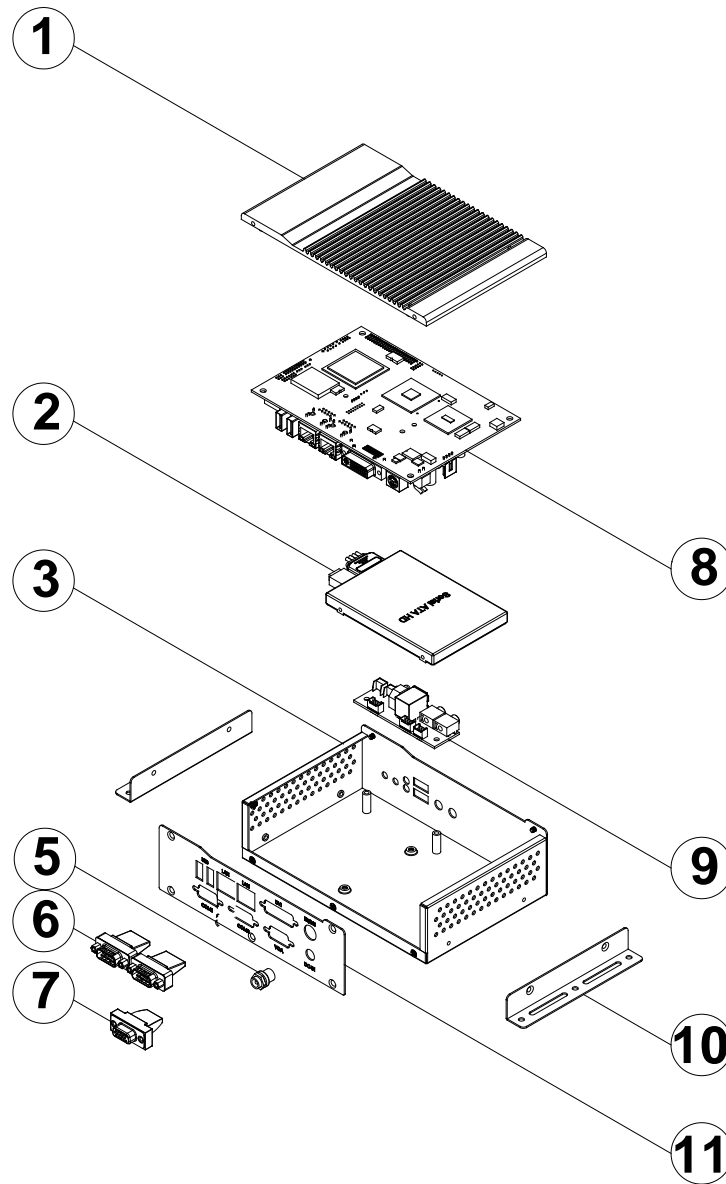

### Parts description

Part NO.	Description	Part NO.	Description
1	Top Cover	2	SATA HDD
3	Base Chassis	4	SATA Cable
5	DC Jack Extension Cable	6	COM1/2 Extension Cable
7	VGA Extension Cable	8	IB883
9	ID737A	10	Mounting rail
11	I/O wall panel		

## **Driver Installation**

Please refer correspond mainboard user manual to install the driver properly.

## **BIOS Setup**

Please refer correspond mainboard user manual to configure BIOS setting.