

# STATIM

## CASSETTE AUTOCLAVE



# Troubleshooting Guide – 5.1

## TABLE OF CONTENTS

**Be sure the error codes match the software revision for the Statim you are repairing.**

Table of Contents	2
Statim Error Codes Revision 2XX Software	3-6
Statim Error Codes Revision 5XX and Higher Software	7-10
Original Statim Error Codes Unit Says <u>Select A Program</u>	11-13
No Power To Statim with PCB Rev. 3.0 or 4.2	14
No Power To Statim with PCB Rev. 2.4 - 2.92 & 6.4	15
Selecting Language & Cover Removal Statim 2000 & 5000	16
Cover Removal Illustration	17
Seal Replacement, Maintenance & Draining the Reservoir Statim 2000 & 5000	18
Boiler Calibration Statim 2000 & 5000 Revision 2XX Software	19
Boiler Calibration Statim 2000 & 5000 Revision 4XX & Higher Software	20-21
Boiler Removal & Replacement Statim 2000 & 5000	22
Alex Boiler Kit Installation Instructions Statim 2000 Revision 4XX Software	23-24
Alex Boiler Kit Installation Instructions Statim 5000 Revision 4XX Software	25-26
Thermal Fuse Removal & Replacement Statim 2000 & 5000	27
Pump, Solenoid & Compressor Tests	28
Pump Filter Cleaning Instructions	29
Solenoid Inspection, Repair, Removal & Replacement Statim 2000 & 5000	30
Microswitch & Reservoir Removal & Replacement Statim 2000 & 5000	31
Water Tester Operation & Diagnosing Water Quality Sensor Problems	32
Setting Time & Date with Printer	33
Printer Operation & Repair	34
Statim 2000 & 5000 Part Numbers & Specifications	35-36
Statim 2000 Parts Front View	37
Statim 2000 Parts Rear View	38
Statim 2000 Parts Bottom View	39
Statim 2000 Parts Top View No Cover	40
Statim 2000 Revision 5XX & Higher Software Alex Parts	41
Statim 5000 Parts Front View	42
Statim 5000 Parts Rear View	43
Statim 5000 Parts Top View No Cover	44
Statim 5000 Revision 5XX & Higher Software Alex Parts	45
Statim 900 Error Codes	46-48
Statim 900 Seal Removal & Replacement	49
Statim 900 Seal Removal & Replacement Illustration	50
Statim 900 Selecting Language & Cover, Drawer & Chamber Removal & Replacement	51
Statim 900 Boiler Calibration	52
Statim 900 Parts & Specifications	53
Statim 900 Parts Front View	54
Statim 900 Parts Rear View	55
Statim 900 Parts Left Side View	56
Statim 900 Parts Right Side View	57
Statim 900 Parts Top View	58

## Statim Error Codes Revision 2XX Software

### All leaks should be corrected before proceeding with troubleshooting

#### Cycle Fault #1

**The cassette temperature failed to reach 95°C within a time-out period.**

1. Boiler does not heat up. No power to boiler. Field Service Tech. repair
2. Check thermal fuse. Using an ohmmeter check for continuity between J1-3 & lower terminal on boiler. If you read less than 1-ohm thermal fuse is good. If thermal fuse checks good proceed to step 3, if bad replace and check unit for proper operation. Test pump using pump tester. Field Service Tech. repair
3. Check resistance reading between J1-3 & J1-4 should read approx. 11ohms. Field Service Tech. repair
4. Check for line voltage at terminals J1-3 & J1-4 during warm up. If the reading is good proceed to step 5, if bad, PCB (Printed Circuit Board) is defective. Shop repair
5. Check for line voltage at boiler terminals. Field Service Tech. repair
6. An extremely large steam leak (Statim 5000). Replace cassette seal, lid or tray. End user repair
7. An extremely large load (Statim 5000). End user repair

#### Cycle Fault #2

**The cassette temperature failed to increase from 95°C to 100°C within a time-out period.**

1. Unit will normally have a major steam leak from the cassette. If cassette is leaking repair as needed. Replace cassette seal, lid or tray. End user repair
2. If the cassette is not leaking, unit is reading incorrect chamber temperature. A calibration cassette is required to check chamber temperature. Shop repair
3. An extremely large load (Statim 5000). End user repair

**Note: The solenoid does not close until the chamber temperature reaches approx. 102°, therefore the solenoid will not cause this error message to appear.**

#### Cycle Fault #3

**The cassette has failed to pressurize and achieve a temperature of 110°C within a time-out period.**

1. Check for visible steam leaks from the cassette. If the cassette is leaking repair as needed. Replace cassette seal, lid or tray. End user repair
2. If no leaks are visible disassemble the solenoid valve and check for debris or the plunger sticking in the plunger tube. Field Service Tech. repair
3. Check for constant power to the solenoid. Measure AC voltage at J1-7 & J1-8, should be zero volts with cassette out of the unit and line voltage with cassette inserted in the unit. Field Service Tech. repair
4. Verify that the check valve and pressure relief valves are not leaking. Field Service Tech. repair

#### Cycle Fault #4

**The cassette has failed to achieve sterilization conditions within 6 minutes of the chamber first reaching 110°C.**

1. Refer to explanation for Cycle Fault #3.

#### Cycle Fault #5 N/A

#### Cycle Fault #6

**The software has detected a steam generator (boiler) temperature 5°C greater than the chamber, within 7.2 seconds after a purge during the sterilizing phase of a cycle.**

1. Calibrate boiler. If problem persists replace and calibrate boiler. Field Service Tech. repair  
**DO NOT clean boiler with CLR**

## Statim Error Codes Revision 2XX Software

### Cycle Fault #7

**The cassette temperature has dropped 4°C below a set point.**

**If the cassette can be removed normally after venting:**

1. Check for visible steam leaks from the cassette. If the cassette is leaking repair as needed. Replace cassette seal, lid or tray. End user repair
2. If no steam leaks are visible disassemble solenoid valve and check for debris. Make sure plunger slides smoothly in plunger tube. Field Service Tech. repair
3. Verify that the check valve and pressure relief valves are not leaking. Field Service Tech. repair

**If the cassette is hard to remove after venting: (Statim 2000 only)**

1. Check for kinked or pinched exhaust tubing. End user repair
2. Check for a clogged venturi in the left rear of the cassette tray. Clean as needed. End user repair
3. Solenoid valve is failing to open. Disassemble and check that plunger slides smoothly in plunger tube. Field Service Tech repair
4. Check for power to solenoid. Using a voltmeter check for line voltage at terminals J1-7 & J1-8 with the cassette inserted. If line voltage is present check for a magnetic field above the solenoid coil. The solenoid coil has a bridge rectifier built into it. To check the coil put your meter on the diode checking scale and read the resistance of the coil, then reverse the leads, the resistance should be approximately the same in both directions. Field Service Tech. repair

### Cycle Fault #8

**The software has detected a steam generator (boiler) temperature 5°C less than the chamber, within 7.2 seconds after a purge during the sterilizing phase of a cycle.**

1. Calibrate boiler. If problem persists replace and calibrate boiler. Field Service Tech. repair

### Cycle Fault #9 N/A

### Cycle Fault #10

**The cassette temperature has failed to drop to 115°C during the Unwrapped or Wrapped Cycle or the temperature has failed to drop to 110°C during the Rubber and Plastics Cycle in the purge conditioning stage.**

1. Check for kinked or pinched exhaust tubing. End user repair
2. Check for a clogged venturi in the left rear of the cassette tray. Clean as needed. End user repair
3. Solenoid valve is failing to open. Disassemble and check that plunger slides smoothly in plunger tube. Field Service Tech repair
4. Check for power to solenoid. Using a voltmeter check for line voltage at terminals J1-7 & J1-8 with the cassette inserted. If line voltage is present check for a magnetic field above the solenoid coil. The solenoid coil has a bridge rectifier built into it. To check the coil put your meter on the diode checking scale and read the resistance of the coil, then reverse the leads, the resistance should be approximately the same in both directions. Field Service Tech. repair

### Cycle Fault #11

**The cassette temperature has failed to drop to 102°C within 60 seconds of the end of a cycle during venting.**

1. Check for kinked or pinched exhaust tubing. End user repair
2. Check for a clogged venturi in the left rear of the cassette tray. Clean as needed. End user repair
3. Solenoid valve is failing to open. Disassemble and check that plunger slides smoothly in plunger tube. Field Service Tech repair
4. Check for power to solenoid. Using a voltmeter check for line voltage at terminals J1-7 & J1-8 with the cassette inserted. If line voltage is present check for a magnetic field above the solenoid coil. The solenoid coil has a bridge rectifier built into it. To check the coil put your meter on the diode checking scale and read the resistance of the coil, then reverse the leads, the resistance should be approximately the same in both directions. Field Service Tech. repair

### Cycle Fault #12

**This indicates a problem with the temperature measuring system.**

1. Check thermocouples, they should read approximately 10 ohms at room temperature. Shop repair

### Cycle Fault #13 N/A

## Statim Error Codes Revision 2XX Software

### Cycle Fault #14

**The steam generator (boiler) temperature is above 171°C during the Sterilization phase of a cycle.**

1. Check pump using the Pump Tester Bottle. Field Service Tech. repair
2. If pump tests weak, clean the pump filters. Field Service Tech. repair
3. Calibrate boiler when pump is functioning properly. Field Service Tech. repair

### Cycle Fault #15

**The cassette temperature is 3°C or more above a set point during the Sterilization phase of the cycle.**

1. Check for kinked or pinched exhaust tubing. End user repair
2. Check for a clogged venturi in the left rear of the cassette tray. Clean as needed. End user repair
3. Solenoid valve is failing to open. Disassemble and check that plunger slides smoothly in plunger tube. Field Service Tech repair

### Cycle Fault #16

**The steam generator (boiler) temperature went above 171°C during the heat up phase of a cycle.**

1. Check pump using the Pump Tester Bottle. Field Service Tech. repair
2. If pump tests weak, clean the pump filters. Field Service Tech. repair
3. Calibrate boiler when pump is functioning properly. Field Service Tech. repair

### Cycle Fault #17-18 N/A

### Cycle Fault #19

**The steam generator (boiler) calibration is invalid. A new calibration is required.**

1. Calibrate the boiler. If problem persists replace Microprocessor and EEPROM (matched set) and calibrate boiler. Field Service Tech. repair

### Cycle Fault #20

**The pump has failed to pump water into the steam generator (boiler) during a pre-vent pump time-out. The steam generator (boiler) temperature was greater than 140°C for 3.6 seconds after the pump was activated to pump water to cool the steam generator (boiler).**

1. Check pump using the Pump Tester Bottle. Field Service Tech. repair
2. If pump tests weak, clean the pump filters. Field Service Tech. repair

### Cycle Fault #21-24 N/A

### Cycle Fault #25

**The software has failed to detect a need to pump water in 90 seconds.**

1. Boiler does not heat up. No power to boiler. Field Service Tech. repair
2. Check thermal fuse. Using an ohmmeter check for continuity between J1-3 & lower terminal on boiler. If you read less than 1-ohm thermal fuse is good. If thermal fuse checks good proceed to step 3, if bad replace and check unit for proper operation. Test pump using pump tester. Field Service Tech. repair
3. Check resistance reading between J1-3 & J1-4 should read approx. 11ohms. Field Service Tech. repair
4. Check for line voltage at terminals J1-3 & J1-4 during warm up. If the reading is good proceed to step 5, if bad, PCB (Printed Circuit Board) is defective. Shop repair
5. Check for line voltage at boiler terminals. Field Service Tech. repair

### Cycle Fault #26

**The sterilization phase has failed to start within 3 minutes of the cassette reaching the sterilization temperature.**

1. Calibrate boiler. If problem persists replace and calibrate boiler. Field Service Tech. repair

### Cycle Fault #27

**The internal temperature of the steam generator (boiler) has exceeded 150°C for 25 seconds.**

1. Check pump using the Pump Tester Bottle. Field Service Tech. repair
2. If pump tests weak, clean the pump filters. Field Service Tech. repair
3. Calibrate boiler when pump is functioning properly. Field Service Tech. repair

## Statim Error Codes Revision 2XX Software

### **Printer Fault**

#### **Message appears if optional printer is installed and not printing.**

1. Check for paper jam. End user repair

#### **No message displayed and printer does not work.**

1. Check the printer ON/OFF switch (white switch). The white switch is both the ON & Off switch for the printer. When the white button is pushed in the printer is ON, when the white button is out the printer is OFF. (The black button is for paper advance only). End user repair
2. Make sure that all printer cables are connected. Cables are correctly connected if the time and date are shown on the LCD. Field Service Tech. repair
3. Ensure that the paper is loaded properly. Check that the paper leaves the paper roll from the top of the roll. This means that the treated surface of the thermal paper will be in contact with the thermal print head. End user repair.

### **Water Quality is Not Acceptable**

1. The water quality sensor has detected water in the reservoir that is above acceptable limits for total dissolved solids. Drain reservoir and refill with known good distilled water. End user repair
2. Check wiring to water pump coil, the white wire should be on terminal closest to the rear of the Statim and the black wire on the terminal closest to the front of the Statim. Field Service Tech. repair
3. Follow instructions for diagnosing water quality sensor problems. Field Service Tech. repair

### **Cycle Interrupted**

1. This message is displayed when there is a power failure in the middle of a cycle or whenever the power is turned off after an error occurred and the STOP button is not pressed.

### **Press Stop To Reset**

1. This message is displayed on all error faults. Press STOP to clear message.

### **GFI (ground fault interrupter) trips when Statim is turned on.**

1. Check for leaking check valve. Field Service Tech. repair

### **Touch pads do not work**

1. Disconnect keypad plug from PCB. Be sure blue plastic piece for keypad plug on PCB is pushed up on the plug pins as far as possible. Reconnect keypad and check. Replace keypad if necessary. Field Service Tech. repair

### **No display or garbled display on LCD**

1. Check plug connections from cover to PCB. Field Service Tech. repair
2. Check to see that the microprocessor is seated firmly in its socket. Field Service Tech. repair

### **Statim makes a clicking noise when cassette removed**

1. This is caused by steam leaking from the cassette. The steam gets into the microswitch causing the contacts to open and close and the solenoid clicks. Repair cassette leak and clicking should stop in approximately 24 hours. End user repair

### **Loud buzzing noise**

1. Clean or replace solenoid as needed. Field Service Tech. repair

### **Noise during drying cycle only**

1. Some check valve noise is normal. Check the air filter. Replace if dirty. End user repair
2. If filter is wet replace check valve and compressor if necessary. Field Service Tech. repair

### **Water dripping from drain tube under Statim**

1. Replace seal or repair cassette as needed. End user repair

### **Steam is escaping from Condenser Bottle vent hole**

1. Ensure that condenser bottle is always filled to Min. line with water. End user repair

### **Steam is leaking from Push-In Fitting at rear of Statim**

1. Ensure that exhaust tube is fully inserted in fitting. Push past initial resistance until tube seats. End user repair

### **Wraps remain wet after drying**

1. Check air filters, if dirty replace. End user repair
2. Ensure that cassette is clean and has been treated with Stat Dri. End user repair
3. Drain tube must run directly to condenser bottle with no dips, loops or kinks. End user repair
4. Do not stack wraps. End user repair
5. Invert mesh rack to provide air space below wraps. End user repair
6. Set bubble level to 4 or 5 o'clock position. End user repair
7. Check for airflow through unit. While the Statim is running in the drying cycle remove exhaust tubing from the top of the waste bottle (be careful tubing may be hot). Place tubing into a cup of water, vigorous bubbles should appear in the cup of water. If bubbles do not appear, check airflow from compressor to waste bottle. End user or Field Service Tech. repair

## Statim Error Codes Revision 5XX & Higher Software

### All leaks should be corrected before proceeding with troubleshooting

#### Cycle Fault #1

**The cassette temperature failed to reach 95°C within a time-out period.**

1. Boiler does not heat up, check thermal fuse. Using an ohmmeter check for continuity between J1-3 & lower terminal on boiler. If you read less than 1-ohm thermal fuse is good. If thermal fuse checks good proceed to step 2, if bad replace and check water pump using Pump Tester Bottle. Field Service Tech. repair
2. Check resistance reading between J1-3 & J1-4 should read approx. 11ohms. Field Service Tech. repair
3. Check for line voltage at terminals J1-3 & J1-4 during warm up. If the reading is good proceed to step 4, if bad, PCB (Printed Circuit Board) is defective. Shop repair
4. Check for line voltage at boiler terminals. Field Service Tech. repair
5. An extremely large steam leak (Statim 5000). Replace cassette seal, lid or tray. End user repair
6. An extremely large load (Statim 5000). End user repair

#### Cycle Fault #2 N/A

#### Cycle Fault #3

**The cassette has failed to pressurize and achieve a temperature of 110°C within a time-out period.**

1. Check for visible steam leaks from the cassette. If the cassette is leaking repair as needed. Replace cassette seal, lid or tray. End user repair
2. Check the solenoid for debris and make sure the plunger is not sticking. Field Service Tech. repair

#### Cycle Fault #4

**The cassette has failed to achieve sterilization conditions within a time-out period of the chamber first reaching 110°C.**

1. Refer to explanation for **Cycle Fault #3**.

#### Cycle Fault #5 N/A

#### Cycle Fault #6

**The software has detected a Validation Thermocouple temperature 5°C greater than the chamber during the sterilizing phase of the cycle.**

1. Check for kinked or pinched exhaust tubing. End user repair
2. Check for visible steam leaks from the cassette. If the cassette is leaking repair as needed. Replace cassette seal, lid or tray. End user repair
3. Check the solenoid and make sure the plunger is not sticking. Field Service Tech. repair
4. Calibrate boiler (validation thermocouple). Field Service Tech. repair

**DO NOT CLEAN BOILER WITH CLR**

#### Cycle Fault #7

**The cassette temperature has dropped 4°C below a set point.**

**If the cassette can be removed normally after venting:**

1. Check for visible steam leaks from the cassette. If the cassette is leaking repair as needed. Replace cassette seal, lid or tray. End user repair
2. Check the solenoid and make sure the plunger is not sticking. Field Service Tech. repair
3. Verify that the check valve and pressure relief valves are not leaking. Field Service Tech. repair

**If the cassette is hard to remove after venting: (Statim 2000 only)**

1. Check for kinked or pinched exhaust tubing. End user repair
2. Check for a clogged venturi in the left rear of the cassette tray. Clean as needed. End user repair
3. Solenoid valve is failing to open. Disassemble and check that plunger slides smoothly in plunger tube. Field Service Tech repair

## Statim Error Codes Revision 5XX & Higher Software

### Cycle Fault #8

**The software has detected a Validation Thermocouple temperature 5°C less than the chamber during the sterilizing phase of the cycle.**

1. Check for a clogged venturi in the left rear of the cassette tray. Clean as needed. End user repair
2. Check the solenoid for debris and make sure the plunger is not sticking. Field Service Tech. repair
3. Check water pump using Pump Tester Bottle. Bottle should fill to the minimum line in **23 to 24 seconds for the Statim 2000** and **21 to 23 seconds for the Statim 5000**. If the bottle fills too quickly replace pump output tubing with tubing having smaller orifice. Also replace microprocessor with 501E or higher software. Field Service Tech. repair
4. Calibrate boiler (validation thermocouple). Field Service Tech. repair

### Cycle Fault #9 N/A

### Cycle Fault #10

**The cassette temperature has failed to drop to 115°C during the Unwrapped or Wrapped Cycle or the temperature has failed to drop to 110°C during the Rubber and Plastics Cycle in the purge conditioning stage.**

1. Check for kinked or pinched exhaust tubing. End user repair
2. Check for a clogged venturi in the left rear of the cassette tray. Clean as needed. End user repair
3. Solenoid valve is failing to open. Disassemble and check that plunger slides smoothly in plunger tube. Field Service Tech repair

### Cycle Fault #11

**The cassette temperature has failed to drop to 102°C within 60 seconds of the end of a cycle during venting.**

1. Check for kinked or pinched exhaust tubing. End user repair
2. Check for a clogged venturi in the left rear of the cassette tray. Clean as needed. End user repair
3. Solenoid valve is failing to open. Disassemble and check that plunger slides smoothly in plunger tube. Field Service Tech repair

### Cycle Fault #12

**This indicates a problem with the temperature measuring system.**

1. Check thermocouples, they should read approximately 10 ohms at room temperature. Shop repair

### Cycle Fault #13-14 N/A

### Cycle Fault #15

**The cassette temperature is 3°C or more above a set point during the Sterilization phase of the cycle.**

1. Check for kinked or pinched exhaust tubing. End user repair
2. Check for a clogged venturi in the left rear of the cassette tray. Clean as needed. End user repair
3. Solenoid valve is failing to open. Disassemble and check that plunger slides smoothly in plunger tube. Field Service Tech repair

### Cycle Fault #16

**The steam generator (boiler) temperature went above 171°C.**

1. Check pump using the Pump Tester Bottle clean the pump filters if needed. Field Service Tech. repair
2. Check for constant power to boiler and replace PCB if needed. Shop repair

### Cycle Fault #17-18 N/A

### Cycle Fault #19

**The boiler (validation thermocouple) calibration is invalid. A new calibration is required.**

1. Calibrate the boiler (validation thermocouple). If problem persists replace Microprocessor and EEPROM (matched set) and calibrate boiler (validation thermocouple). Field Service Tech. repair

### Cycle Fault #20

**The pump has failed to pump water into the steam generator (boiler) during a pre-vent pump time-out. The steam generator (boiler) temperature was greater than 140°C for 3.6 seconds after the pump was activated to pump water to cool the steam generator (boiler).**



1. Check pump using the Pump Tester Bottle clean the pump filters if needed. Field Service Tech. repair

**Cycle Fault #21-24 N/A**

## Statim Error Codes Revision 5XX & Higher Software

### Cycle Fault #25

**The software has failed to detect a need to pump water in 90 seconds.**

1. Boiler does not heat up. No power to boiler. Field Service Tech. repair
2. Check thermal fuse. Using an ohmmeter check for continuity between J1-3 & lower terminal on boiler. If you read less than 1-ohm thermal fuse is good. If thermal fuse checks good proceed to step 3, if bad replace and check unit for proper operation. Test pump using pump tester. Field Service Tech. repair
3. Check resistance reading between J1-3 & J1-4 should read approx. 11ohms. Field Service Tech. repair
4. Check for line voltage at terminals J1-3 & J1-4 during warm up. If the reading is good proceed to step 5, if bad, PCB (Printed Circuit Board) is defective. Shop repair
5. Check for line voltage at boiler terminals. Field Service Tech. repair

### Cycle Fault #26

**The sterilization phase has failed to start within 3 minutes of the cassette reaching the sterilization temperature. Cycle Fault 26 is displayed when this occurs in three consecutive cycles. (Cycle Interrupted is displayed for the first two cycles). Cycle Fault 26 counter is reset whenever a successful cycle is completed.**

1. Check for visible steam leaks from the cassette. If the cassette is leaking repair as needed. Replace cassette seal, lid or tray. End user repair
2. Check the solenoid for debris and make sure the plunger is not sticking. Field Service Tech. repair
3. Calibrate boiler (validation thermocouple). Field Service Tech. repair

### Cycle Fault #27

**The temperature of the steam generator (boiler) has failed to drop below a set point temperature in a timeout period.**

1. Check pump using the Pump Tester Bottle clean the pump filters if needed. Field Service Tech. repair

### Cycle Fault #72

**There is a communication error between the microprocessor and the Temperature Adapter Board.**

1. Check the connection between the square microprocessor and the PCB. Field Service Tech. repair
2. If PCB adapter board is used check the connection between the adapter board and the PCB. Field Service Tech. repair
3. Verify that the Temperature Adapter Board is properly inserted and secure on the main PCB. Field Service Tech. repair

### Cycle Fault #98

**Square microprocessor failed to communicate with PCB.**

1. Check that pins on square microprocessor are not shorted.
2. If PCB adapter board is used check for bent pins.
3. Check the pins on the Temperature Adapter Board. Field Service Tech. repair

### Printer Fault

**Message appears if optional printer is installed and not printing.**

1. Check for paper jam. End user repair

**No message displayed and printer does not work.**

1. Check the printer ON/OFF switch (white switch). The white switch is both the ON & Off switch for the printer. When the white button is pushed in the printer is ON, when the white button is out the printer is OFF. (The black button is for paper advance only). End user repair
2. Make sure that all printer cables are connected. Cables are correctly connected if the time and date are shown on the LCD. Field Service Tech. repair
4. Ensure that the paper is loaded properly. Check that the paper leaves the paper roll from the top of the roll. This means that the treated surface of the thermal paper will be in contact with the thermal print head. End user repair.

### Water Quality is Not Acceptable

1. The water quality sensor has detected water in the reservoir that is above acceptable limits for total dissolved solids. Drain reservoir and refill with known good distilled water. End user repair
2. Check wiring to water pump coil, white wire on terminal closest to the rear of the Statim and the black wire on the terminal closest to the front of the Statim. Field Service Tech. repair
3. Follow instructions for diagnosing water quality sensor problems. Field Service Tech. repair

## Statim Error Codes Revision 5XX & Higher Software

### **Cycle Interrupted**

1. This message is displayed when the sterilization phase has failed to start within three minutes of the cassette reaching the sterilization temperature. If it occurs in three consecutive cycles Cycle Fault #26 is displayed. Field Service Tech. repair
2. This message is displayed when there is a power failure in the middle of a cycle or whenever the power is turned off after an error occurred and the STOP button is not pressed.

### **Press Stop To Reset**

1. This message is displayed on all error faults. Press STOP to clear message.

### **GFI (ground fault interrupter) trips when Statim is turned on.**

1. Check for leaking check valve. Field Service Tech. repair

### **Touch pads do not work**

1. Disconnect keypad plug from PCB. Be sure blue plastic piece for keypad plug on PCB is pushed up on the plug pins as far as possible. Reconnect keypad and check. Replace keypad if necessary. Field Service Tech. repair

### **No display or garbled display on LCD**

1. Check plug connections from cover to PCB. Field Service Tech. repair
2. Check to see that the microprocessor is seated firmly in it's socket. Field Service Tech. repair

### **Statim makes a clicking noise when cassette removed**

1. This is caused by steam leaking from the cassette. The steam gets into the microswitch causing the contacts to open and close and the solenoid clicks. Repair cassette leak and clicking should stop in approximately 24 hours. End user repair

### **Loud buzzing noise**

1. Clean or replace solenoid as needed. Field Service Tech. repair

### **Noise during drying cycle only**

1. Some check valve noise is normal. Check the air filter. Replace if dirty. End user repair
2. If filter is wet replace check valve and compressor if necessary. Field Service Tech. repair

### **Water dripping from drain tube under Statim**

1. Replace seal or repair cassette as needed. End user repair

### **Steam is escaping from Condenser Bottle vent hole**

1. Ensure that condenser bottle is always filled to Min. line with water. End user repair

### **Steam is leaking from Push-In Fitting at rear of Statim**

1. Ensure that exhaust tube is fully inserted in fitting. Push past initial resistance until tube seats. End user repair

### **Wraps remain wet after drying**

1. Check air filters, if dirty replace. End user repair
2. Ensure that cassette is clean and has been treated with Stat Dri. End user repair
3. Drain tube must run directly to condenser bottle with no dips, loops or kinks. End user repair
4. Do not stack wraps. End user repair
5. Invert mesh rack to provide air space below wraps. End user repair
6. Set bubble level to 4 or 5 o'clock position. End user repair
7. Check for airflow through unit. While the Statim is running in the drying cycle remove exhaust tubing from the top of the waste bottle (be careful tubing may be hot). Place tubing into a cup of water, vigorous bubbles should appear in the cup of water. If air bubbles do not appear check airflow from compressor to waste bottle. End user or Field Service Tech. repair

## Original Statim Error Codes Unit Says Select A Program

**Before using the Original Statim Error Codes verify that the Statim says Select A Program when turned on. All leaks should be corrected before proceeding with troubleshooting.**

### Check Cassette #1

**The cassette temperature failed to reach 95°C in three minutes.**

1. Boiler does not heat up. No power to boiler. Field Service Tech. repair
2. Check thermal fuse. Using an ohmmeter check for continuity between J1-3 & lower terminal on the boiler. If you read less than 1-ohm the thermal fuse is good. If thermal fuse checks good proceed to step 3, if bad replace and check unit for proper operation. Test pump using pump tester. Field Service Tech. repair
3. Check resistance reading between J1-3 & J1-4 should read approx. 11ohms. Field Service Tech. repair
4. Check for line voltage at terminals J1-3 & J1-4 during warm up. If the reading is good proceed to step 5; if bad PCB (Printed Circuit Board) is defective. Shop repair
5. Check for line voltage at boiler terminals. Field Service Tech. repair

### Check Cassette #2

**The cassette temperature failed to increase from 95 to 100°C within 80 seconds.**

1. Unit will normally have a major steam leak from the cassette. If cassette is leaking repair as needed. Replace cassette seal, lid or tray. End user repair
2. If the cassette is not leaking, unit is reading incorrect chamber temperature. A calibration cassette is required to check chamber temperature. Shop repair

**Note: The solenoid does not close until the chamber temperature reaches approx. 102°, therefore the solenoid will not cause this error message to appear.**

### Check Cassette #3

**The cassette has failed to pressurize and achieve a temperature of 110°C within 70 seconds of pressurization.**

1. Check for visible steam leaks from the cassette. If the cassette is leaking repair as needed. Replace cassette seal, lid or tray. End user repair
2. If no leaks are visible disassemble the solenoid valve and check for debris or the plunger sticking in the plunger tube. Field Service Tech. repair
3. Check for constant power to the solenoid. Measure AC voltage at J1-7 & J1-8, should be zero volts with cassette out of the unit and line voltage with cassette inserted in the unit. Field Service Tech. repair
4. Verify that the check valve and pressure relief valves are not leaking. Field Service Tech. repair

### Check Cassette #4

**The Cassette has failed to achieve sterilization conditions within 10 minutes of the chamber first reaching 102°C.**

1. Refer to explanation for **Check Cassette #3**.

### Check Cassette #5

**The software causes the pump to activate while between 2 minutes 44 seconds and 2 minutes 24 seconds remaining in the cycle. If a request to pump water occurs outside of 2 minutes 44 seconds Check Cassette #5 occurs.**

1. Check pump and boiler. Field Service Tech. repair
2. Check pump using Pump Tester Bottle. Field Service Tech. repair
3. If pump tests weak and is a new style pump, check the pump filters. Field Service Tech. repair
4. If pump is old style, replace the pump. Field Service Tech. repair
5. If the pump tests good, the boiler needs to be replaced. Shop repair

**Note: When checking pumps if the pump is louder than normal check the input filter. If the pump sounds normal or quieter than normal check the output filter.**

### Check Cassette #6

**Boiler temperature is more than 5°C higher than the chamber while sterilizing.**

1. When the display changes from "pressurization" to "sterilization" does it take longer than 10 seconds for the pressure information (xxxKpa) to appear in the read-out? Replace boiler. Shop repair

## Original Statim Error Codes Unit Says Select A Program

### Check Cassette #7

**Chamber temperature is below the lower limit 130.5°C during the sterilizing phase of the Unwrapped/Wrapped Cycle or below 117.5°C during the sterilizing phase of the Rubber and Plastics Cycle. If the cassette can be removed normally after venting:**

1. Check for visible steam leaks from the cassette. If the cassette is leaking repair as needed. Replace cassette seal, lid or tray. End user repair
2. If no steam leaks are visible, disassemble the solenoid and check for debris or the plunger sticking in the plunger tube. Field Service Tech. repair
3. Verify that the check valve and pressure relief valves are not leaking. Field Service Tech. repair

**If the cassette is hard to remove after venting:**

1. Check for kinked or pinched exhaust tubing. End user repair
2. Check for a clogged venturi in the left rear of the cassette tray. Clean as needed. End user repair
3. Solenoid valve is failing to open. Disassemble and check that plunger slides smoothly in plunger tube. Field Service Tech repair
4. Check for power to solenoid. Using a voltmeter check for line voltage at terminals J1-7 & J1-8 with the cassette inserted. If line voltage is present check for a magnetic field above the solenoid coil. The solenoid coil has a bridge rectifier built into it. To check the coil put your meter on the diode checking scale and read the resistance of the coil, then reverse the leads, the resistance should be approximately the same in both directions. Field Service Tech. repair

### Check Cassette #8

**Chamber temperature is more than 5°C higher than the boiler while sterilizing.**

1. Check the exhaust tube for kinks. End user repair
2. Check for a clogged venturi in the cassette. End user repair
3. Check to see if the condenser bottle is full of hot water. End user repair
4. When the cassette changes from "pressurization" to "sterilization" does it take longer than 10 seconds for the pressure information (xxxKpa) to appear in the read-out? Replace boiler. Shop repair

### Check Cassette (no number)

**The cassette temperature has failed to drop below 103°C within a timeout period at the end of a cycle.**

1. Check for kinked or pinched exhaust tubing. End user repair
2. Check for a clogged venturi in the left rear of the cassette tray. Clean as needed. End user repair
3. Solenoid valve is failing to open. Disassemble and check that plunger slides smoothly in plunger tube. Field Service Tech repair
4. Check for power to solenoid. Using a voltmeter check for line voltage at terminals J1-7 & J1-8 with the cassette inserted. If line voltage is present check for a magnetic field above the solenoid coil. The solenoid coil has a bridge rectifier built into it. To check the coil put your meter on the diode checking scale and read the resistance of the coil, then reverse the leads, the resistance should be approximately the same in both directions. Field Service Tech. repair

### Service Needed

**The boiler temperature has exceeded 170°C or the chamber temperature has exceeded 147°C or a thermocouple is broken.**

**Does the Service Needed message appear as soon as the cycle button is pressed, before pressing the start button?**

1. A thermocouple or the PCB is bad. Thermocouples should read approx. 10 ohms at room temperature. Shop repair.

**Does the Service Needed message appear after the start button is depressed and the cycle starts?**

1. Check the pump using the Pump Tester Bottle. Field Service Tech. repair
2. If pump tests weak and is a new style pump, check the pump filters. Field Service Tech. repair
3. If pump is old style, replace the pump. Field Service Tech. repair
4. If the pump tests good, the boiler needs to be replaced. Shop repair

**Note: When checking pumps if the pump is louder than normal check the input filter. If the pump sounds normal or quieter than normal check the output filter.**

## **Original Statim Error Codes Unit Says Select A Program**

### **Select A Program is displayed in the middle of a cycle.**

1. Check the microswitch. Disconnect the microswitch wires and measure with an ohmmeter. With the cassette inserted should read less than 1 ohm, with cassette removed should read open (infinite). Field Service Tech. repair

### **Insert Cassette is displayed when the cassette is inserted fully and the Start button is pressed.**

1. Check to see if the chamber thermocouple is bent. End user check
2. Check microswitch. Field Service Tech. repair
3. Check probe bracket roller spring under steam input and exhaust ports. Bend spring down slightly if needed. Field Service Tech. repair

### **Distilled H2O Only**

1. The water quality sensor has detected water in the reservoir that is above acceptable limits for total dissolved solids. Drain reservoir and refill with known good distilled water. End user repair
2. Follow instructions for diagnosing water quality sensor problems. Field Service Tech. repair

### **PRV leaking steam**

1. Check the cassette seal. Be sure that the steam input and exhaust ports are open. One hole is open completely the second hole is open half way through the seal. End user repair
2. Check elbow fitting and copper tube from boiler to probe bracket. Make sure they are not clogged. Field Service Tech. repair
3. If seal is installed correctly and elbow fitting and copper tube are clear, replace PRV. Field Service Tech. repair

### **GFI (ground fault interrupter) trips when Statim is turned on.**

1. Check for leaking check valve. Field Service Tech. repair

### **Touch pads do not work**

1. Disconnect keypad plug from PCB. Be sure blue plastic piece for keypad plug on PCB is pushed up on the plug pins as far as possible. Reconnect keypad and check. Replace keypad if necessary. Field Service Tech. repair

### **No display or garbled display on LCD**

1. Check plug connections from cover to PCB. Field Service Tech. repair
2. Check to see that the microprocessor is seated firmly in it's socket. Field Service Tech. repair

### **Statim makes a clicking noise when cassette removed**

1. This is caused by steam leaking from the cassette. The steam gets into the microswitch causing the contacts to open and close and the solenoid clicks. Repair cassette leak and clicking should stop in approximately 24 hours. End user repair

### **Loud buzzing noise**

1. Clean or replace solenoid as needed. Field Service Tech. repair

### **Noise during drying cycle only**

1. Some check valve noise is normal. Check the air filter. Replace if dirty. End user repair
2. If filter is wet replace check valve and compressor if necessary. Field Service Tech. repair

### **Water dripping from drain tube under Statim**

1. Replace seal or repair cassette as needed. End user repair

### **Steam is escaping from Condenser Bottle vent hole**

1. Ensure that condenser bottle is always filled to Min. line with water. End user repair

### **Steam is leaking from Push-In Fitting at rear of Statim**

1. Ensure that exhaust tube is fully inserted in fitting. Push past initial resistance until tube seats. End user repair

### **Wraps remain wet after drying**

1. Check air filters, if dirty replace. End user repair
2. Ensure that cassette is clean and has been treated with Stat Dri. End user repair
3. Drain tube must run directly to condenser bottle with no dips, loops or kinks. End user repair
4. Do not stack wraps. End user repair
5. Invert mesh rack to provide air space below wraps. End user repair
6. Set bubble level to 4 or 5 o'clock position. End user repair
7. Check for airflow through unit. While the Statim is running in the drying cycle remove exhaust tubing from the top of the waste bottle (**be careful tubing may be hot**). Place tubing into a cup of water, vigorous bubbles should appear in the cup of water. If bubbles do not appear, check airflow from compressor to waste bottle. End user or Field Service Tech. repair

## No Power To Statim with PCB Rev. 3.0 or 4.2

1. Verify that there is no display and no green power light.
2. Check outlet to make sure there is power.
3. Verify power switch is turned **ON**.
4. With power switch **OFF** check all fuses for continuity.
5. Turn main power switch **ON**.
6. Using a voltmeter check for line voltage at bottom two terminals on the left side of the PCB, J1-1 and J1-2. If line voltage is present proceed to step 7. If not check for burnt wiring from power cord to the power switch to the PCB.
7. Check For line voltage on the left side of the two 15 amp fuses. Place one meter lead on the left side of the upper fuse (F1) and one meter lead on the left side of the lower fuse (F2). If line voltage is present proceed to step 8. If not check the PCB for a bad connection between terminal J1-1 and the lower 15 amp fuse (F2) or terminal J1-2 and the upper 15 amp fuse (F1).
8. Check for line voltage on the right side of the two 15 amp fuses. Place one meter lead on the right side of the upper fuse (F1) and one meter lead on the right side of the lower fuse (F2). If line voltage is present the PCB is bad. If line voltage is not present recheck the 15 amp fuses or check for a bad connection at the fuse holders.

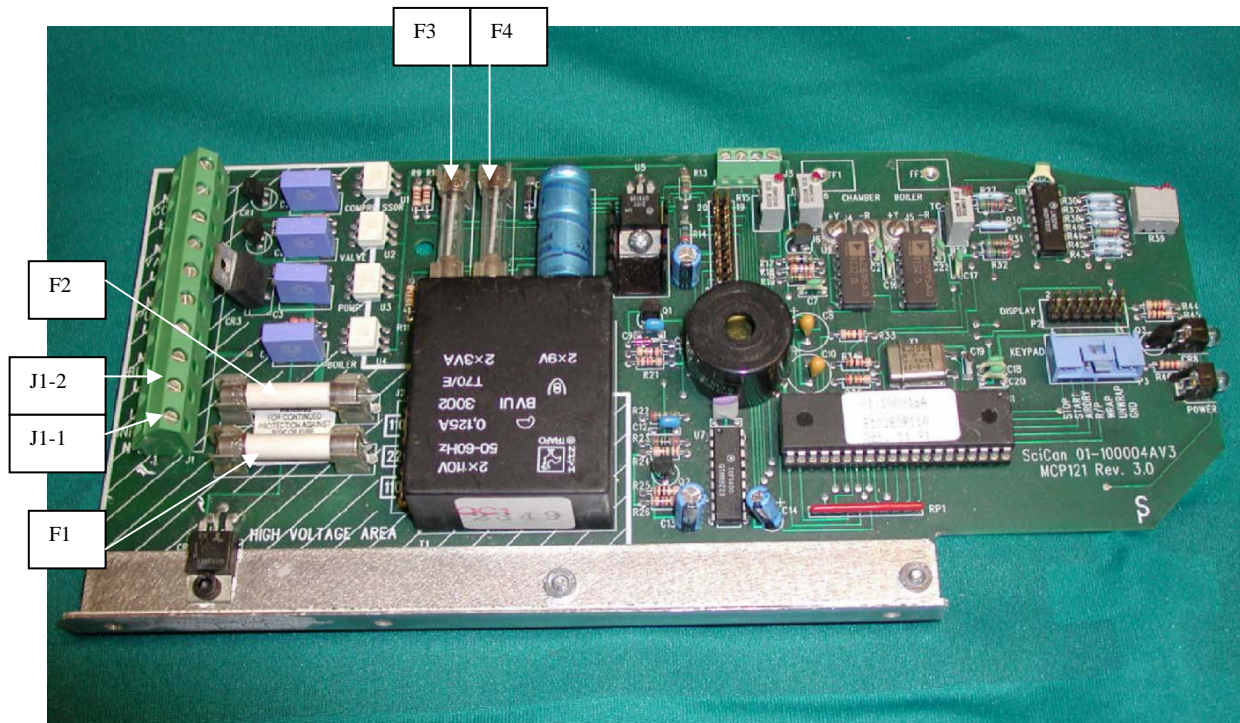



## No Power To Statim with PCB Rev. 2.4-2.92 & 6.4

1. Verify that there is no display and no green power light.
2. Check outlet to make sure there is power.
3. Check that power cord is plugged into electrical outlet and back of Statim.
4. Verify power switch is turned **ON**.
5. With power switch **OFF** check all fuses for continuity.
6. Turn power switch **ON**.
7. Using a voltmeter check for line voltage at bottom two terminals on the left side of the PCB, J1-1 and J1-2. If line voltage is present proceed to step 8. If not check for burnt wiring from power cord to the power switch to the PCB.
8. Check for line voltage on the left side of the two 15 amp fuses. Place one meter lead on the left side of the upper fuse (F2) and one meter lead on the left side on the lower fuse (F3). If line voltage is present proceed to step 9. If not check the PCB for a bad connection between Terminal J1-1 and the lower 15 amp fuse (F3) or terminal J1-2 and the upper 15 amp fuse (F2).
9. Check for line voltage on the right side of the two 15 amp fuses. Place one meter lead on the right side of the upper fuse (F2) and one meter lead on the right side of the lower fuse (F3). If line voltage is present the PCB is bad. If line voltage is not present recheck 15 amp fuses or check for bad connection at fuse holders.

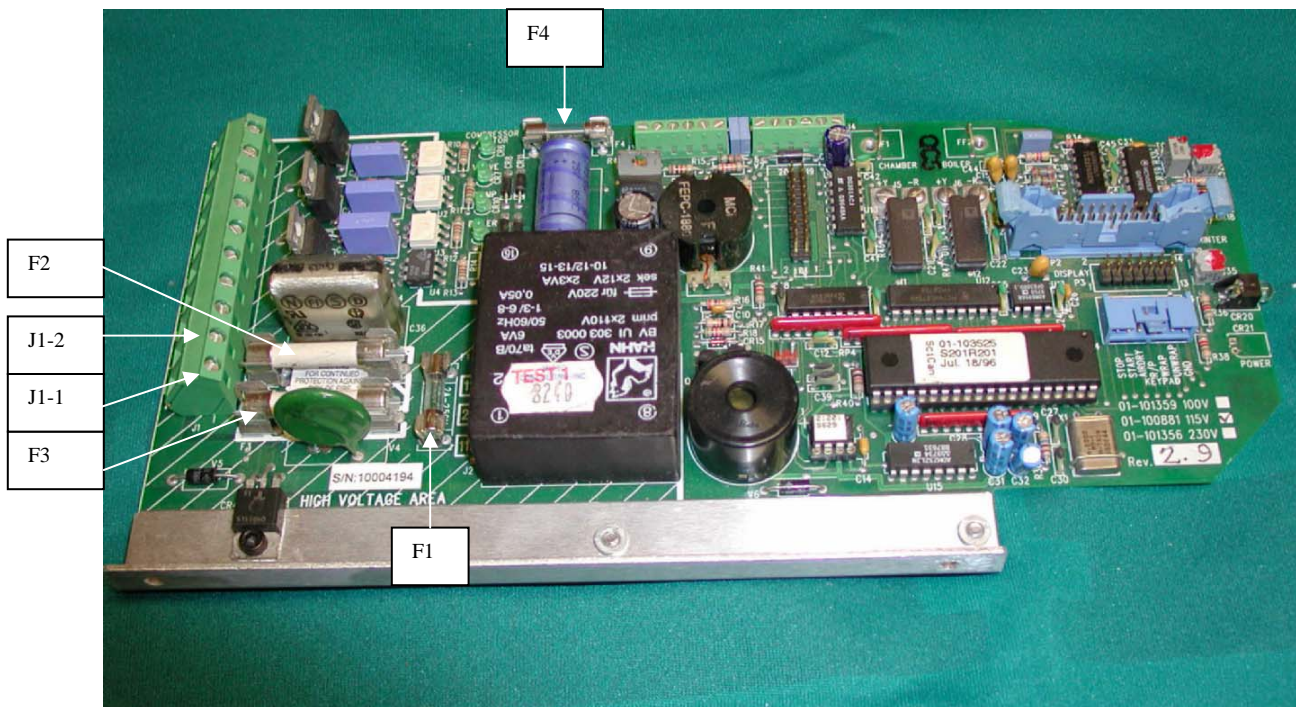



## Selecting the Operating Language 2000 & 5000

1. Turn the power switch to the OFF position.
2. Press and hold the WRAPPED button on the keypad. At the same time, turn the power switch, at the rear of the Statim, ON.
3. Press the WRAPPED button again to scroll to the next language.
4. Press the UNWRAPPED button to scroll to the previous language.
5. When the desired language is displayed, press the STOP button to save the selection and return to the regular operating mode.

## Statim 2000 & 5000 Cover Removal and Replacement (See Illustration on Page 17)

### To remove the Statim 2000 & 5000 cover, follow these steps:

1. Unplug the Statim and remove the cassette, filler cap, 4 side screws and 3 rear screws.
2. On the Statim 5000 the middle screw in the rear is behind the biological filter, holding the filter bracket.
3. With the facia overhanging the edge of the counter or table, lift up on the rear of the cover until it clears the internal components, and then slide the cover forward about an inch.
4. Gently rotate the cover up and pivot it around the front left corner of the machine. When the cover is clear of the machine, rest it on its side. Take care not to strain the ribbon cables connecting the display and keypad.
5. Observe the orientation of the ribbon cable connections. Disconnect the LCD and Keypad connectors from the PCB.
6. Replace the reservoir cap onto the top of the reservoir.

### To replace the Statim 2000 & 5000 covers, follow these steps:

1. Inspect the facia gasket located on the inside front portion of the cover. If it is damaged or fails to adhere to the surface of the cover, it must be replaced.
2. Remove the reservoir cap from the top of the reservoir.
3. Rest the cover beside the left side of the unit. Reconnect the LCD and Keypad connectors to the PCB.
4. Plug the Statim in and turn the power switch ON. If the amber light is flashing or the Solenoid is clicking repeatedly, the LCD connector is incorrectly installed. If the green power light is on and the LCD is reading correctly, press all of the Keypad buttons and check for proper display messages. After checking, turn the power switch OFF and unplug the unit.
5. Carefully lift the cover from the work surface. While rotating the cover slide it forward until the facia clears the PCB and the front of the armature.
6. Tilt the front of the cover down and the rear of the cover upwards. Carefully reposition the front portion of the cover back over the front of the PCB and armature. Ensure that the LED's at the front left hand corner of the unit fit into the clearance holes in the cover. BE CAREFUL NOT TO PINCH THE RIBBON CABLES.
7. When the front of the cover is in place, lower the rear portion of the cover, and gently push backwards. Carefully realign the screw holes and reinstall the three screws with lock washers across the rear of the unit. If the unit is a Statim 5000 reinstall the biological filter bracket where the center screw goes in the rear of the unit.
8. Reinstall the four remaining screws two on each side.
9. Plug the unit in and turn the power switch ON. Verify that the LCD and Keypad are functioning properly and the green and amber lights are visible through the cover.

Statim 2000 & 5000 Cover Removal and Replacement Illustration

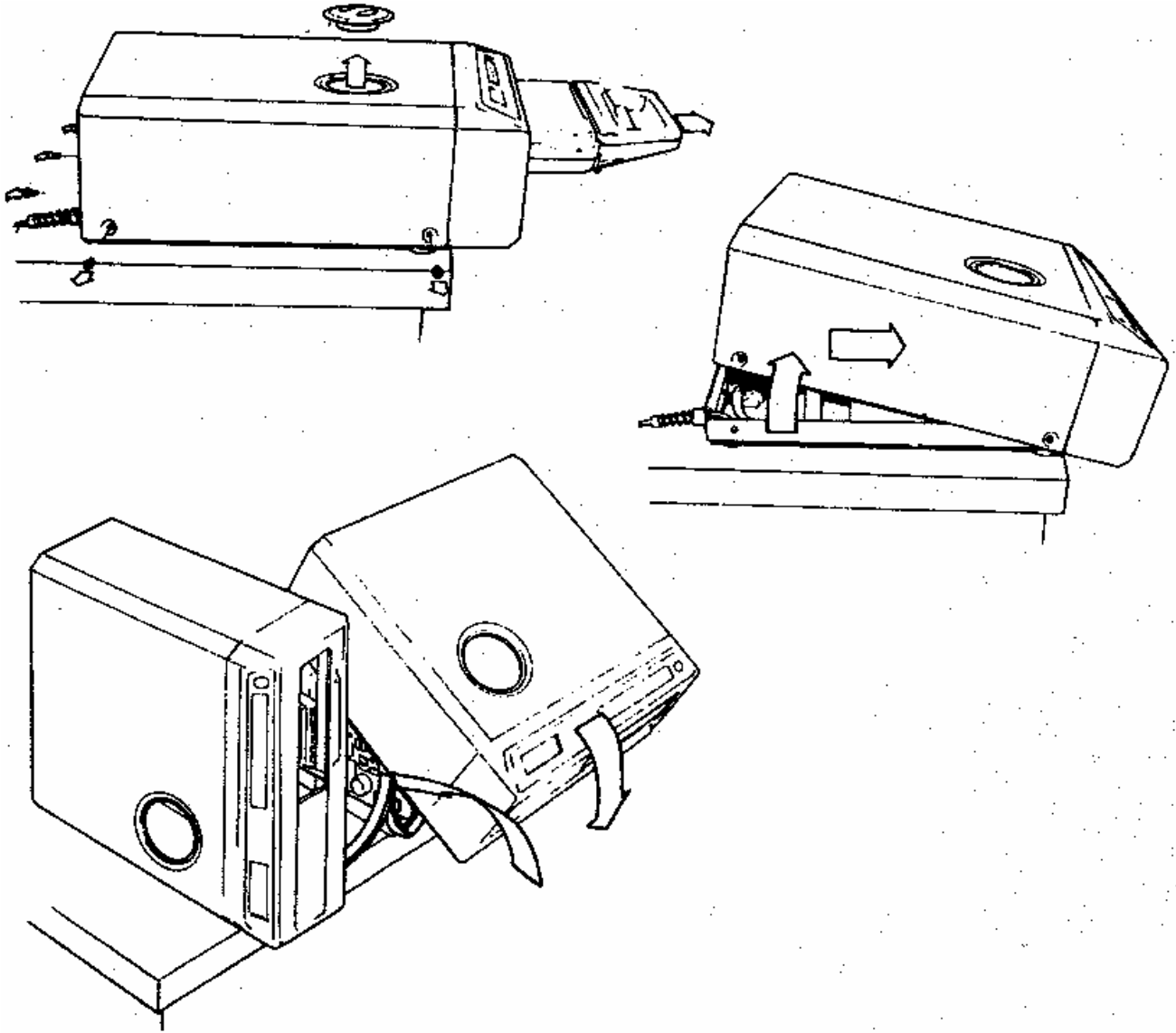

## Seal Replacement, Maintenance & Draining the Reservoir Statim 2000 & 5000

The cassette seal will last approximately 500 cycles. There should be no steam leaking from the front of the Statim or water dripping from under the Statim. To change the seal follow these instructions:

1. Place the cassette lid and the new seal on a clean work surface.
2. Examine the position of the old seal in the cassette lid and arrange the new seal in the same orientation.
3. Remove the old seal with a small screwdriver, sliding it behind the corner of the seal and pulling the seal from the channel. Clean any residue from the seal channel.
4. Thoroughly lubricate the new seal.
5. Align the holes in the new seal with the holes in the lid.
6. Install the holes first, and then install the four corners allowing the sides to hang out. Be sure that two indicator squares are visible in each corner.
7. Starting in the middle of a long side insert the rounded edge of the seal into the channel. Work from the middle to one corner, then from the middle to the opposite corner. Install all four sides the same way.
8. Check to see that the seal is fully inserted into the channel on all four sides. Check the corners to see that two indicator squares are visible in each corner. Check the two holes to be sure that they are centered in the cutouts.
9. If there is a small steam leak or water under the unit after installing the new seal, check the outside edge of the cassette tray for residue, clean if necessary, then try another cycle. It may take time to seat the new seal. If the leak persists, remove the seal and reinstall. If unit continues to leak after installing seal for the second time try a new cassette lid or tray.

### Care and Maintenance of the Statim Cassette

Use a non-chloride cleanser (i.e. Cameo, Zud or Bar Keepers Friend) and a green scratch pad. At least once a week clean the inside of the lid of the cassette and the inside of the tray and the outside edge of the lower tray. After cleaning, rinse and dry, then apply a liberal amount of Stat-Dri to the inside metal surfaces. This SciCan product induces water to form an even coat on the inside surface without beading. The water in contact with the hot cassette surfaces also evaporates much more efficiently. Spotting is minimized and instruments dry much better. Stat-Dri should be applied every 10 cycles, and after every cassette cleaning. Clean the outside surface of the Statim with a mild soap and water. The seal in the cassettes will last approximately 500 cycles.

### Draining the Reservoir Statim 2000 & 5000

**If you must service the reservoir, ship a Statim or move the unit more than a short distance follow these directions:**

To drain the water from the reservoir of the Statim use a high volume evacuation (HVE) hose from a vacuum system. Insert the hose into the reservoir and allow it to suction the water out. If suction is unavailable carefully move the Statim to the edge of the work surface. Lift the front left corner of the Statim upward and remove the drain tube from the clip located on the underside of the unit. Gently pull the tube out as far as possible so the free end can be positioned over a water container. Remove the plug from the end of the drain tube and allow the water to drain from the reservoir. When water no longer drips from the drain tube, replace the plug. Lift the front left corner of the Statim upward and re-insert the tube into the clip. Push the excess length of tubing back from where it came. **Not all Statim 2000 units have a drain tube.** If a vacuum system is not available the water must be siphoned from the reservoir of these units. **Do not turn the Statim upside down and dump the water out!** A retrofit drain kit is available for the Statim 2000. (Drain Tubing Kit #01-108152S)

### Changing Air Compressor and Biological Filters

The filters should be replaced every six months or after 500 cycles. The filters are located on the rear of both Statims. Not all Statims have both filters.

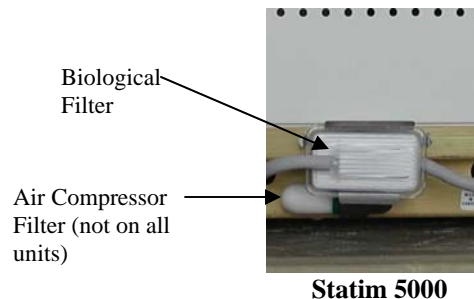
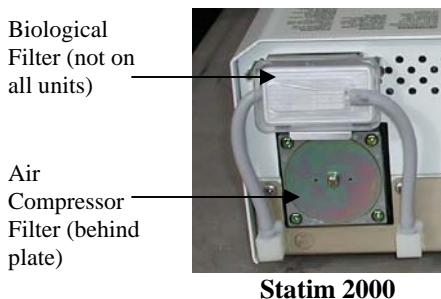

## Boiler Calibration 2000 & 5000 Revision 2XX Software

1. Turn the main power switch OFF and remove the cover. Check to see that the reservoir has enough distilled water to cover the water quality sensor.
2. Short together pins W1 located to the left of the microprocessor on the PCB. Turn the power switch ON.
3. The LCD will show CALIBRATING with two digits in the upper left corner of the display and two digits in the upper right corner of the display. The value in the lower left corner of the display is the difference between the boiler (steam generator) and chamber temperatures. The value in the lower right corner of the display is the chamber temperature. The display should appear similar to example 1.

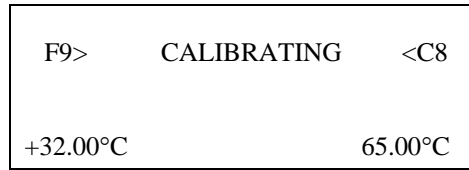

EXAMPLE 1

4. **Insert a cassette.**
5. To start the boiler self-calibration cycle, hold down the UNWRAPPED button and press the START button. The two digits in the upper left corner will change to 00> and an asterisk\* will appear after the message CALIBRATING\*. The display should appear similar to example 2

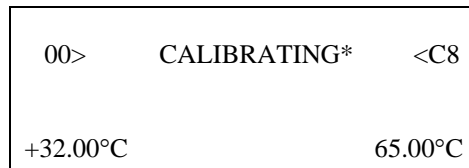

EXAMPLE 2

6. The calibration cycle will last approximately 5 minutes. A long beep will sound when the calibration is complete. The 00> in the upper left corner of the display should change to two digits. Once the 00> changes the calibration cycle is complete. The display should appear similar to example 3.

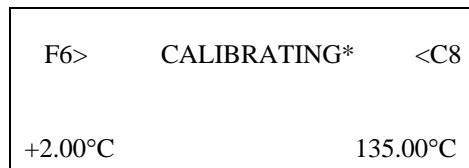

EXAMPLE 3

7. Press the STOP button and allow the Statim to vent. When the display says PRESS STOP TO RESET the venting is complete press the STOP button again. The display should say SELECT A CYCLE. You may now run normal cycles.

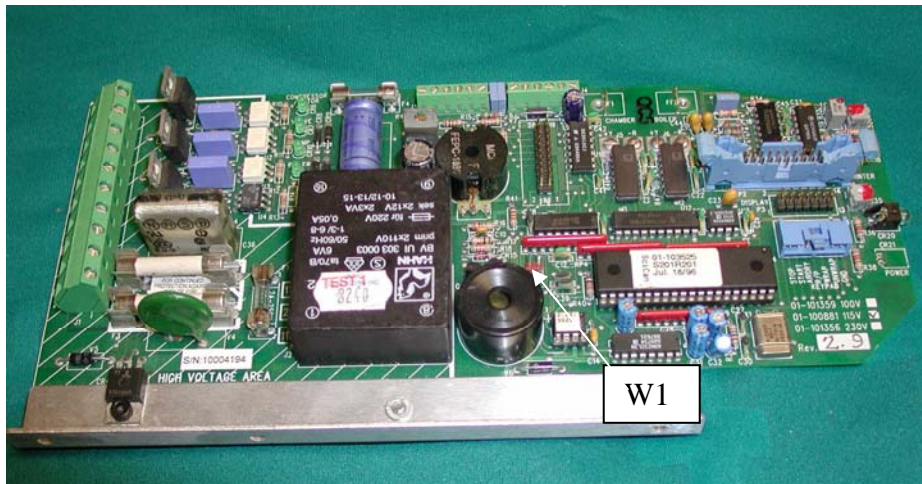



# Boiler Calibration 2000 & 5000 Revision 4XX & Higher Software

## Revision 6.4 PCB

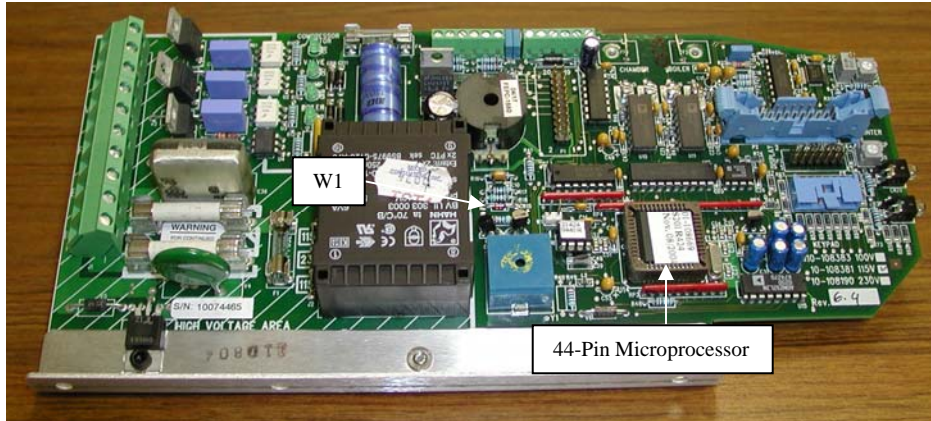

## Revision 2.9 PCB with PCB Adapter Board

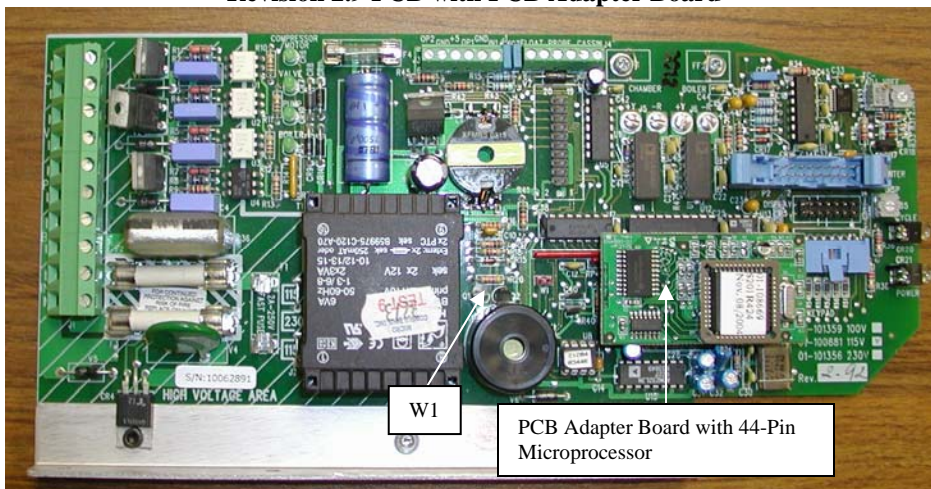

## Revision 2.9 PCB with Temperature and PCB Adapter Boards for Alex

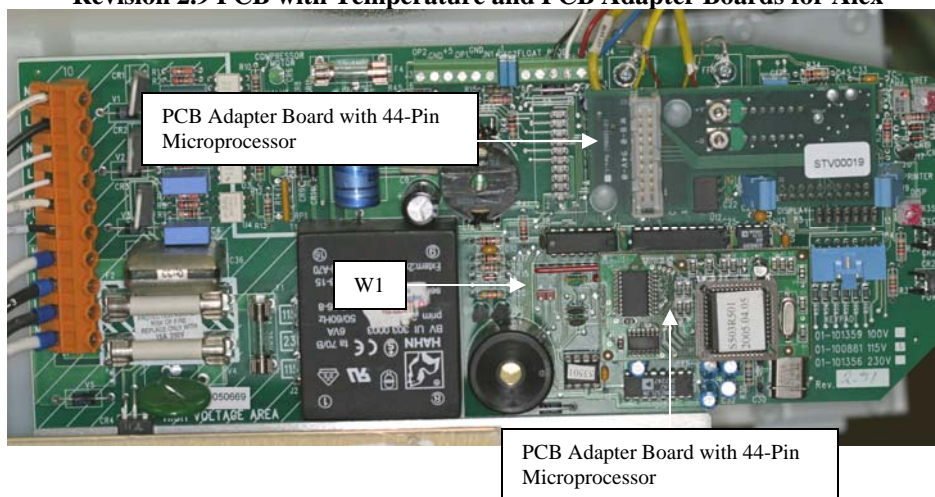

## Boiler (Steam Generator) Calibration Revision 4XX & Higher Software

1. Turn the main power switch OFF and remove the cover. Check to see that the reservoir has enough distilled water to cover the water quality sensor.
2. Short together pins W1 located to the left of the microprocessor on the PCB. Turn the power switch ON.
3. The LCD will appear similar to example 1. The value in the lower right-hand corner of the display is the difference between the boiler and chamber temperatures. The value in the upper left corner is the boiler temperature. The following two digits in the upper left corner of the display represent the boiler offset value in hexadecimal. The two digits in the upper right corner of the display represent the chamber-offset value in hexadecimal and to the left of the chamber-offset value is the chamber temperature.

25.5	C8	24.1	F9
		1.4	

**EXAMPLE 1**

### 4. INSERT A CASSETTE.

5. To start the boiler self-calibration cycle, hold down the UNWRAPPED button and press the START button. The unit will beep three times and the boiler-offset value will change to 00, an asterisk will appear after the 00\* the display should appear similar to example 2.

25.5	00*	24.1	F9
		1.4	

**EXAMPLE 2**

6. The calibration cycle will proceed and when the unit reaches the sterilization phase of the cycle the unit will beep twice. After 3.5 minutes the unit will vent indicating the boiler calibration is complete. The boiler-offset value in the upper left corner of the display has changed to display the new boiler-offset value. The display should appear similar to example 3.

145.5	F3*	135.9	F9
		9.6	

**EXAMPLE 3**

7. After venting is complete press the STOP button to end the boiler calibration cycle.

## **Boiler (Steam Generator) Removal and Replacement**

**NOTE: NEW BOILER MUST BE CALIBRATED**

**To remove the boiler (steam generator), follow these steps:**

**Make sure the power switch is OFF, and the unit is unplugged.**

1. Carefully cut the high temperature tie wrap holding the compressor tube onto the check valve inlet and pull the tube off the check valve.
2. Disconnect the boiler thermocouple wires from the PCB terminal position BOILER +Y and -R. Disconnect the flag terminal or ground lug from the position marked BOILER. Retain the flag terminal or ground screw. Leave the screws with contact washers in the terminals.
3. Disconnect the black thermal fuse wire from PCB terminal J1-3 and the white neutral wire from terminal J1-4.
4. Trace the path of the black wire back to the base of the boiler. Carefully cut all the tie wraps holding the black and white wires.
5. Carefully cut the tie wraps securing the boiler thermocouple lead and other wires to the armature.
6. Using a 3/8-inch wrench, disconnect the compression nut holding the Teflon tube from the top of the boiler.
7. Using a 7/16-inch wrench, disconnect the compression nut holding the boiler outlet tube to the boiler outlet fitting.
8. Disconnect the compression nut holding the boiler outlet tube to the probe bracket inlet fitting.
9. Remove the two screws holding the boiler mounting bracket to the chassis and remove the boiler.

**To replace the boiler (steam generator), follow these steps:**

1. Carefully install the boiler mounting bracket to the chassis using two screws. Start the screws into the tapped holes but do not tighten the screws.
2. Connect the compression nut holding the boiler outlet tube to the top of the boiler outlet fitting and the compression nut holding the boiler outlet tube to the probe bracket inlet fitting. Thread the nuts finger tight, and then tighten using a 7/16-inch wrench. **DO NOT OVERTIGHTEN.**
3. Tighten the two screws holding the boiler mounting bracket to the chassis.
4. Connect the compression nut holding the Teflon tube from the pump to the top of the boiler. Thread the nut finger tight, and then tighten using a 3/8-inch wrench. **DO NOT OVERTIGHTEN.**
5. Route the white neutral wire and the black thermal fuse wire from the boiler along the back of the chassis with the other wires. Connect the black thermal fuse wire to terminal J1-3 and the white neutral wire to terminal J1-4. Bundle the wires along the back of the chassis, as new, using tie wraps.
6. Carefully bent and route the new boiler thermocouple lead along-side the chamber thermocouple lead to the PCB. Reconnect the ground terminal to the threaded lug marked BOILER on the PCB. Connect the thermocouple leads yellow to terminal +Y and red to -R. Bundle the thermocouple, microswitch and sensor leads, as new, using tie wraps.
7. Carefully push the compressor tube onto the check valve inlet and secure the tube to the valve using a high temperature tie wrap (blue).
8. **Calibrate the boiler.**

## Alex Boiler Kit Installation Instructions Statim 2000 Revision 4XX Software

- 1. Check software version on the display**  
S201R4XX order spare parts kit 01-108993S  
*Kit includes Boiler, Validation Thermocouple, Temperature Adapter Board & Microprocessor Kit*  
S201R5XX unit already upgraded to Alex boiler  
Alex Boiler part #01-108979S  
Microprocessor part #01-108976S  
Temperature Adapter Board Alex part #01-108981S  
Validation Thermocouple Statim 2000 part #01-108983S

- 2. Installation Sequence**  
Remove boiler. **Do not install Alex Boiler at this time.**

Replace exhaust copper tubing with Validation Thermocouple Assembly.  
Check the Validation Thermocouple Assembly to be sure the ferrule moves freely on the copper tubing. Push the tubing into the "T" fitting as far as possible.

**Wrong**



**Right**



### **Install the Alex Boiler.**

Connect the Validation Thermocouple wires to the Temperature Adapter Board. Connecting the red wire to (-R) and the yellow wire to (+Y). Secure the thermocouple by the anti-rotation jumper with a cable tie.

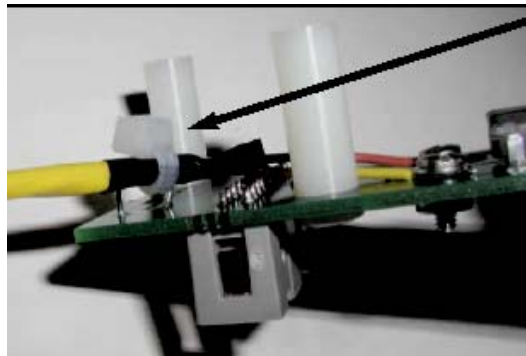

Anti-rotation  
jumper



Insert the Temperature Adapter Board into the printer connector socket.

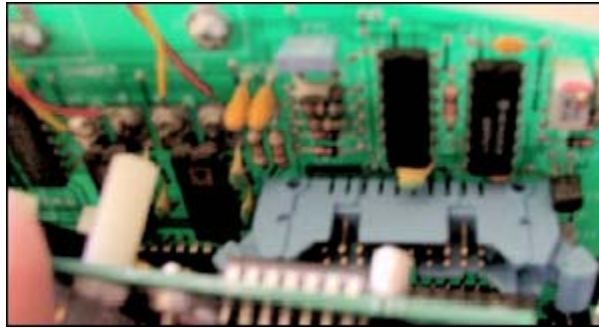

Upgrade the software using PCB Adapter Board if required and revision 5XX Microprocessor and EEPROM.

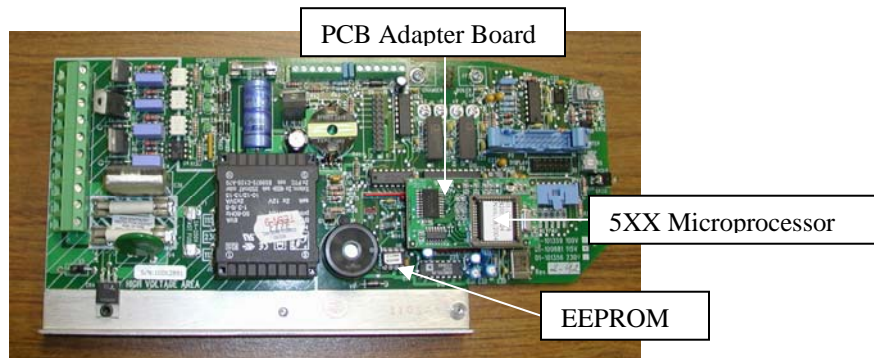

**Calibrate the Boiler (Validation Thermocouple).**

## Alex Boiler Kit Installation Instructions Statim 5000 Revision 4XX Software

- 1. Check software version on the display**  
S501R4XX order spare parts kit 01-108995S  
*Kit includes Boiler, Validation Thermocouple, Temperature Adapter Board & Microprocessor Kit*  
S501R5XX unit already upgraded to Alex boiler  
Alex Boiler part #01-108980S  
Microprocessor part #01-108977S  
Temperature Adapter Board Alex part #01-108981S  
Validation Thermocouple Statim 5000 part #01-108984S

- 2. Installation Sequence**  
Remove boiler. **Do not install Alex Boiler at this time.**

Replace exhaust copper tubing with Validation Thermocouple Assembly.

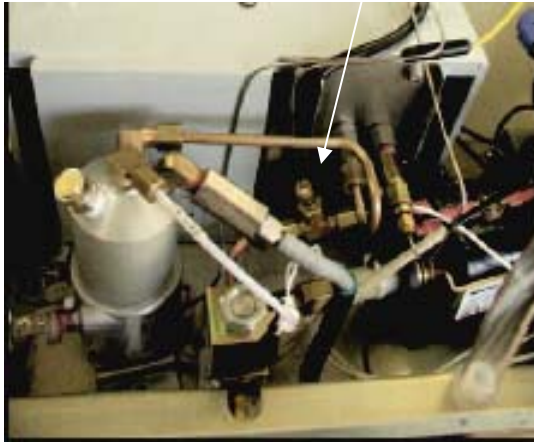

### **Install the Alex Boiler.**

Connect the Validation Thermocouple wires to the Temperature Adapter Board. Connecting the red wire to (-R) and the yellow wire to (+Y). Secure the thermocouple by the anti-rotation jumper with a cable tie.

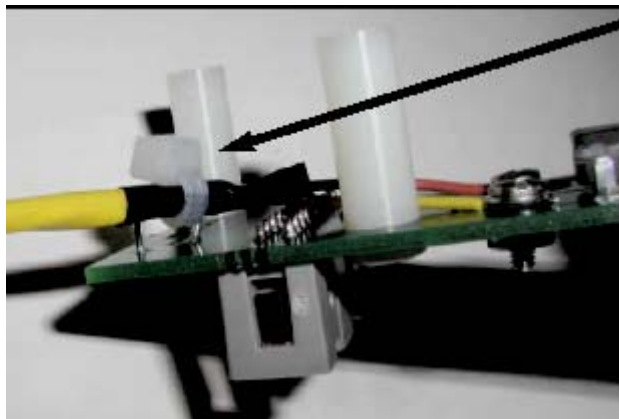

Anti-rotation  
jumper

Insert the Temperature Adapter Board into the printer connector socket.

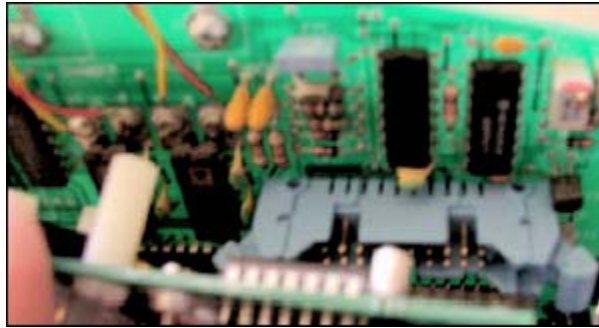

Upgrade the software using PCB Adapter Board if required and revision 5XX Microprocessor and EEPROM.

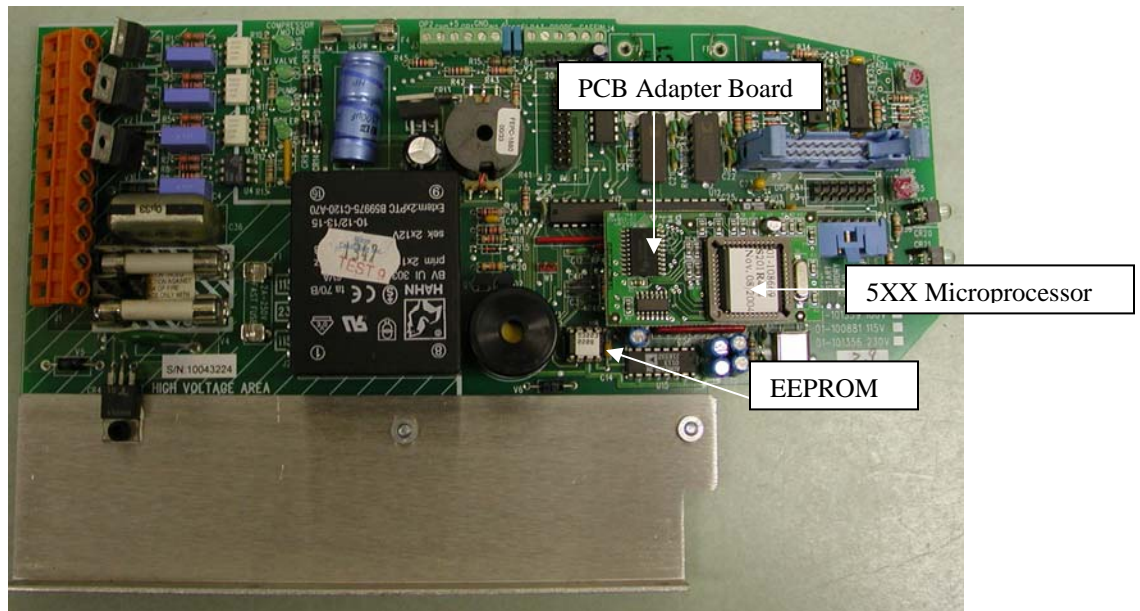

**Calibrate the Boiler (Validation Thermocouple).**

## Thermal Fuse Removal and Replacement

**To remove the thermal fuse assembly, follow these steps:**

**Make sure the power switch is OFF, and the unit is unplugged.**

1. Carefully cut the high temperature tie wrap holding the compressor tube onto the check valve inlet and pull the tube off the check valve.
2. Disconnect the black thermal fuse wire from the PCB terminal block J1-3. This black wire is integral to the thermal fuse assembly.
3. Trace the path of the black wire back to the base of the boiler. Carefully cut all the tie wraps holding the black wire.
4. Disconnect the white wire attached to the terminal on the lower half of the boiler.
5. Using a 3/8-inch wrench, disconnect the compression nut holding the white Teflon tube from the top of the boiler.
6. Using a 7/16-inch wrench, disconnect the compression nut holding the boiler outlet tube to the probe bracket inlet fitting.
7. Using a 7/16-inch wrench disconnect the compression nut holding the boiler outlet tube to the boiler outlet fitting.
8. Remove the two screws from the boiler bracket. The boiler is still attached to the PCB by the thermocouple lead.
9. Gently lift and turn the boiler assembly onto one side to expose the bottom of the assembly. **BE CAREFUL NOT TO STRESS THE THERMOCOUPLE LEADS.**
10. Remove the screw, which attaches the boiler mounting bracket to the boiler. This screw is shorter than the screws used to hold the bracket to the chassis.
11. Disconnect the thermal fuse from the lower power terminal on the boiler. Note the routing of the thermal fuse assembly between the mounting bracket and spacing standoffs on the bottom of the boiler.

**To replace the thermal fuse assembly, follow these steps:**

1. Connect the thermal fuse to the lower power terminal on the boiler.
2. Attach the boiler mounting bracket to the boiler using the small screw. Route the wire from the fuse assembly between the mounting bracket and spacing standoffs on the bottom of the boiler. The fuses must be placed exactly between the standoffs. **DO NOT PINCH OR CRUSH THE WIRE BETWEEN THE MOUNTING BRACKET AND THE STANDOFFS.**
3. Carefully return and attach the boiler assembly to the chassis using two screws. Start the screws into the tapped hole but do not tighten the screws. **BE CAREFUL NOT TO STRESS THE THERMOCOUPLE LEADS.**
4. Connect the compression nut holding the boiler outlet tube to the boiler outlet fitting. Tighten finger tight.
5. Connect the compression nut holding the boiler outlet tube to the probe bracket inlet fitting. Tighten finger tight.
6. Connect the compression nut holding the white Teflon pump tube to the top of the boiler. Tighten finger tight, then continue to tighten the nut using a 3/8-inch wrench. **DO NOT OVER-TIGHTEN.**
7. Tighten the two screws that attach the boiler assembly to the chassis.
8. Using a 7/16-inch wrench, tighten the compression nut holding the boiler outlet tube to the boiler outlet fitting. Tighten the compression nut holding the boiler outlet tube to the probe bracket fitting.
9. Connect the white wire to the terminal on the lower half of the boiler using the screw with captive lock washer. If the terminal appears blackened, clean it using fine grit sandpaper.
10. Route the black wire from the thermal fuse along the back of the chassis with the other wires. Connect the black thermal fuse wire to terminal J1-3.
11. Bundle the wires along the back of the chassis, as new, using tie wraps.
12. Carefully push the compressor tube onto the check valve inlet and secure the tube to the valve using a high temperature tie wrap (blue).



## Pump Solenoid & Compressor Tests

### Pump Tester Instructions

1. Disconnect the Teflon boiler inlet tube from the top of the boiler.
2. Connect the disconnected end of the inlet tube to the pump tester.
3. Activate the pump by shorting P1-16 to ground on the PCB (see pictures below) for 2 seconds to purge any air that is trapped in the fittings. Empty any water that enters the pump tester. The pump tester must be empty before starting the pump test.
4. Be prepared to record the time it takes for the water level in the pump tester bottle to reach the line marked **MIN**. Activate the pump by shorting P1-16 to ground on the PCB.
5. For **Statim 2000** the water level should reach the **MIN** line within **23-24** seconds.
6. For **Statim 5000** the water level should reach the **MIN** line within **21-23** seconds.
7. If the pump fails the pump test clean the pump filters (see page 30).

### Solenoid & Compressor Tests

1. The solenoid may be activated by shorting P1-18 to ground on the PCB.
2. The compressor may be activated by shorting P1-20 to ground on the PCB.

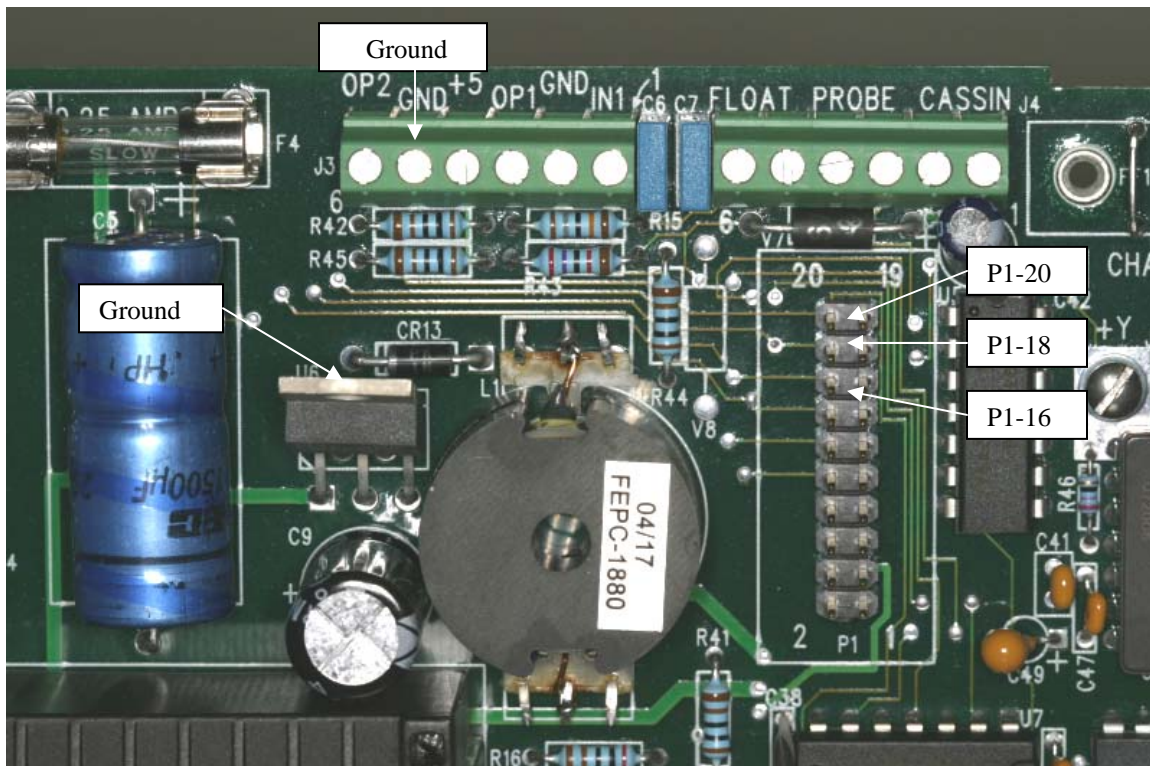

## Pump Filter Cleaning Instructions

The inlet fitting of the SciCan pump contains a coarse mesh filter. Most SciCan pumps also have a fine mesh filter in the outlet elbow fitting. To clean the filters rinse them under clean running water and scrub with a toothbrush if necessary. To remove and clean the filters follow these steps:

1. Crimp the pump inlet hose with a pair of hemostats and remove the hose from the pump inlet fitting.
  2. Remove the inlet fitting from the pump.
  3. Insert a blunt instrument in the threaded end of the fitting and push the filter out through the barb.
  4. Clean the inlet filter and reinstall, push filter into barb with a blunt instrument.
  5. Draw a black line through the three parts on the output side of the pump (see picture below).
  6. Remove the pump outlet Teflon tubing from the pump at the elbow fitting.
  7. Remove the elbow fitting and the brass bushing from the white fitting on the pump.
  8. Disconnect outlet elbow fitting from the brass bushing.
  9. Clean the fine mesh filter on the input side of the elbow fitting and reinstall the fittings aligning the black lines.
- Do not over tighten the brass bushing into the white fitting on the pump.**
10. Test pump for proper output using Pump Tester Bottle (part #01-100713S).
  11. Replacement Pump Filter Kit (part #01-104501S). Contains inlet and outlet filters.

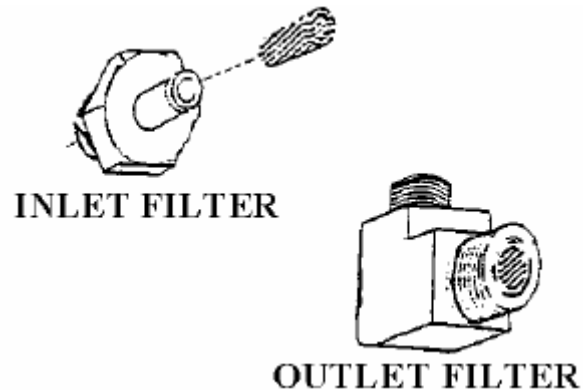
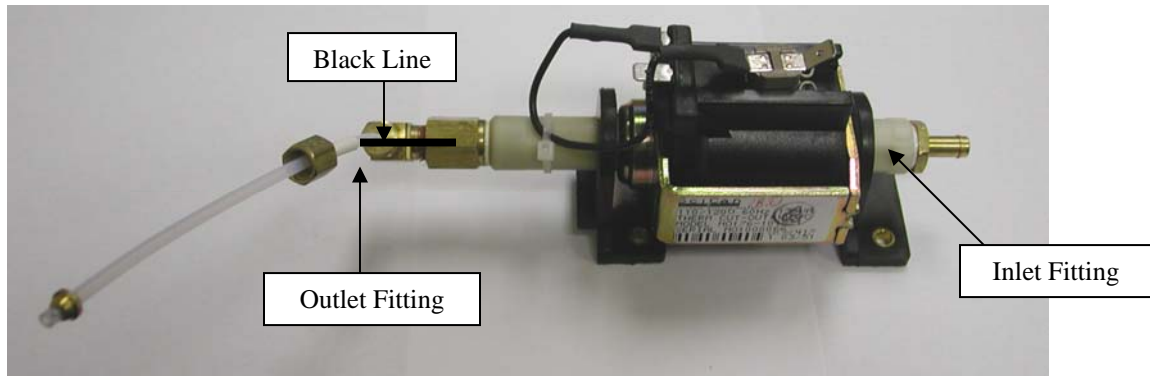

## Solenoid Valve Inspection and Repair (Honeywell & Parker solenoids only)

### See Picture

1. Ensure that the power is off. Disassembly of the solenoid valve with the power on will cause valve coil damage.
2. Remove the retaining nut, yoke and coil from the top of the valve.
3. Unscrew the plunger tube assembly. The tube may be removed by carefully gripping the tube above the weld with a pair of pliers and turning counterclockwise.
4. Remove the plunger (take care not to lose the spring) and inspect the plunger seal. If the plunger seal is damaged replace it with solenoid repair kit (part #01-100998S).
5. Remove any debris found in the valve body and blow air through all orifices.
6. Clean the plunger and ensure that the plunger slides smoothly in the plunger tube.
7. Reassemble the solenoid valve.

### Solenoid Valve Removal and Replacement

To remove the solenoid valve assembly, follow these steps:

**Make sure the power switch is OFF, and the unit is unplugged.**

1. Carefully cut the tie wraps securing the solenoid coil wires to the wiring harness and disconnect the leads from the PCB terminals J1-7 and J1-8.
2. Using a 7/16-inch wrench, disconnect the compression nut holding the outlet probe tube to the outlet probe fitting on the probe bracket assembly.
3. Remove the two screws that attach the solenoid valve mounting bracket to the chassis, one on the inside of the chassis, one on the outer rear surface of the chassis.

To replace the solenoid valve assembly, follow these steps:

1. Connect a new outlet probe tube to the solenoid valve inlet fitting. Thread the compression nut; finger tight, on the inlet fitting.
2. Place the solenoid valve assembly in the unit.
3. Connect the other end of the outlet probe tube to the outlet probe fitting on the probe bracket. Thread the compression nut; finger tight, on the inlet fitting. Tighten the nuts on both ends of the outlet probe tube using a 7/16-inch wrench. **DO NOT OVERTIGHTEN.**
4. Attach the solenoid valve mounting bracket to the chassis.
5. Route the solenoid coil wires together with the bundle of wires extending to the PCB and connect the leads to terminals J1-7 and J1-8. These wires are interchangeable in the positions.
6. Bundle the wires along the back of the chassis, as new, using tie wraps.

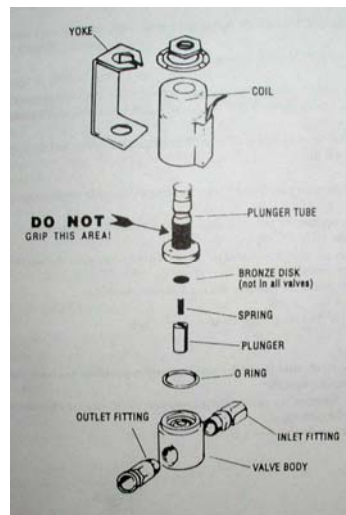

## Microswitch Removal and Replacement

**To remove the microswitch, follow these steps:**

**Make sure the power switch is OFF, and the unit is unplugged.**

1. Disconnect the microswitch leads from the PCB header terminal positions labeled CASSIN and carefully cut the cable ties securing the microswitch leads.
2. There may be RTV silicone sealant on the heads of the two screws securing the microswitch to the side of the probe bracket. Trim away the excess RTV silicone and remove the screws. **Do Not remove the probe bracket to get at the screws.** If you have trouble getting at the screws disconnect the compressor tube between the check valve and the compressor and remove the four compressor mounting screws. Set the compressor off the back of the Statim being careful not to damage the wiring.
3. Remove the microswitch.
4. Remove all RTV silicone residues from the probe bracket surface.

**To replace the microswitch, follow these steps:**

1. Attach the replacement microswitch to the probe bracket.
2. Connect the microswitch leads to the PCB header terminal labeled CASSIN.
3. Bundle the microswitch leads, thermocouple leads and sensor leads together, as new, with tie wraps.
4. Plug in the power cord and turn on the main power switch. When the cassette is fully inserted you should hear the solenoid valve click.
5. Once installed and functioning, a thin bead of RTV silicone sealant may be applied along the edges of the microswitch if available.

## Reservoir Removal and Replacement

**To remove the reservoir, follow these steps:**

**Make sure the power switch is OFF, and the unit is unplugged.**

1. **DRAIN THE RESERVOIR.**
2. Cut the necessary tie wraps and remove the water quality sensor leads from the PCB terminal positions labeled PROBE J4-3 and J4-4 or the float switch leads from terminal positions labeled FLOAT J4-5 and J4-6.
3. Cut the tie wrap securing the reservoir supply tube to the pump fitting and remove the tube from the fitting.
4. Tilt the unit on its side so that the reservoir and PCB are towards the ceiling. Locate and remove three nylon cap nuts with washers on the bottom of the chassis securing the reservoir.
5. Carefully remove the reservoir from the chassis. **BE CAREFUL NOT TO DAMAGE THE THERMOCOUPLE LEADS.**

**To replace the reservoir, follow these steps:**

1. Carefully place and secure the reservoir in the chassis using three nylon cap nuts with washers.
2. Reconnect the reservoir supply tube to the pump fitting. Secure the tube using a tie wrap.
3. When filling the reservoir with steam distilled water, touch the leads of the water quality sensor or float switch to ground to discharge any static electric charge, which may have built up on the reservoir. This reduces the chance of ESD damage to the PCB.
4. Connect the water quality sensor leads to the PCB terminal positions labeled PROBE or the float switch leads to terminal positions labeled FLOAT.
5. Bundle the reservoir sensor leads, the microswitch leads and the thermocouple leads together and secure them, as new, using tie wraps.



## SciCan Water Tester Operation

1. Remove the protective cap.
2. Rinse the tester in distilled water up to the maximum immersion line.
3. Turn the pure H<sub>2</sub>O Tester on.
4. Immerse it in the sample without exceeding the maximum immersion level.
5. Read the value on the display in  $\mu\text{S}/\text{cm}$ .
6. Distilled water should read less than  $10\mu\text{S}$  (5PPM).
7. If the display reads (1 .), The reading is over  $100\mu\text{S}$ .
8. Conversion  $2\mu\text{S} = 1\text{PPM}$

## Diagnosing Water Quality Sensor Problems

1. To check the PCB, measure the negative voltage across test connector P1-1 and P1-3. If the voltage reading is not within  $-8.4$  to  $-9.7\text{VDC}$ , the PCB is bad. (See pictures below)
2. Turn off the power; disconnect the sensor leads from the probe terminals J4-3 and J4-4.
3. Turn on the power and start an unwrapped cycle.
4. If a "Refill Reservoir Empty Waste Bottle" message appears on the LCD, proceed to step 5. If the cycle starts when the sensor leads are disconnected, the PCB is bad.
5. Short the probe terminals J4-3 and J4-4. Start a cycle. If the unit displays a "Water Quality Is Not Acceptable" message, proceed to step 6. If not the PCB is bad.
6. Remove the short from probe terminals J4-3 and J4-4. Short the float terminals J4-5 and J4-6. If the cycle starts the PCB is good, the sensor is bad. If the display reads, "Water Quality Is Not Acceptable" the PCB is bad.
7. To test the sensor, short the sensor posts using a long screwdriver. The sensor should read less than 1 ohm.

**P1 Location**

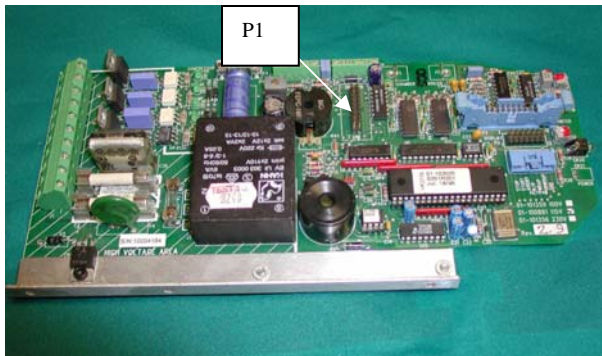

**P1-1 & P1-3 Pins**

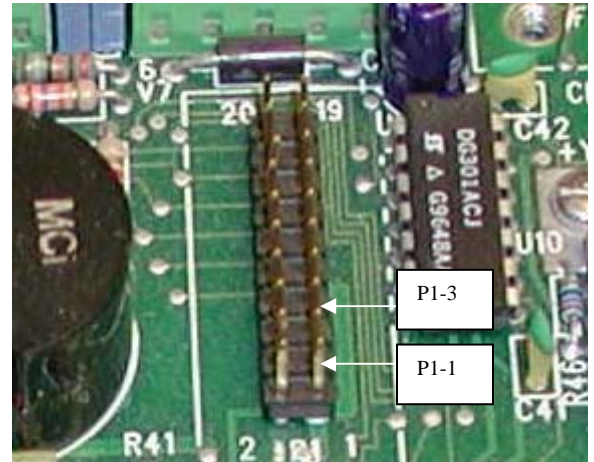

## Setting Time and Date on Statim with Printer

**The time and date feature is available with the optional printer only. To set the time and date follow these steps while watching the blinking cursor on the LCD.**

1. Turn the main power switch off.
2. Press and hold the UNWRAPPED button on the front of the Statim. At the same time, turn on the main power switch at the back of the Statim. The display should appear similar to the example.



### EXAMPLE

**NOTE: The date reads day, month and year.**

3. There are five fields on the display showing the hours (24 hour clock), minutes, day, month and year. The cycle buttons of the keypad are used to select a field for setting and changing that field's value. The blinking cursor highlights the field currently selected.
4. To increase the value of the selected field, press the UNWRAPPED cycle button. Hold the button down to continuously increase the value.
5. To decrease the value of the selected field, press the WRAPPED cycle button. Hold the button down to continuously decrease the value.
6. To select the next field for setting, press the RUBBER AND PLASTICS cycle button. Press the button repeatedly to select subsequent fields.
7. To save changes and return to regular operating mode, press the STOP button.

## Printer Operation and Repair

### Installing paper into the printer:

**NEVER PULL THE PAPER BACKWARD THROUGH THE PRINTER. THIS WILL DAMAGE THE PRINTER MECHANISM.**

1. Open the printer door by gently pushing on the top half of the door.
2. Press the white power button to turn the printer on.
3. **Note: The white button is for ON and OFF. Pressed in is ON, sticking out is OFF. The black button is for paper advance only.**
4. Unroll some paper from the thermal paper roll and trim the corners so they are rounded. Use the paper cutting template if available.
5. Move the paper roll arm into the loading position. Place the paper roll on the arm so the paper strip feeds from the top of the roll and then carefully insert it into the paper feed slot until it stops.
6. **Note: If the paper does not feed from the top, the heat sensitive side of the paper will not be in contact with the print head and the printer will not print.**
7. With one hand, continue to gently feed the paper strip into the paper feed slot. With the other hand, press the black paper advance button until the paper feeds by itself. Keep the paper straight when feeding it into the printer, or it may jam. **DO NOT FORCE THE PAPER INTO THE SLOT.** If the paper will not feed into the slot, prepare the end of the roll as described in step 4 and reload the paper.
8. Continue to press the black paper advance button until the paper feeds through the paper exit slot on the front of the printer. Then move the paper roll arm into the operating position. Check to be sure that the white button is pressed in so printer is ON. Close the printer door. The printer is now ready to operate.
9. **If paper jams in the printer and cannot be removed by pressing the black paper advance button, do not pull the paper backward through the printer. Never put a utensil or tool into the printer exit slot. See Removing Paper Jams.**

### Removing Paper Jams:

1. Turn the Statim off and unplug the unit.
2. Using scissors cut the paper between the roll and the paper feed slot.
3. Remove the paper roll from the paper roll arm and leave the arm in the loading position.
4. Using a Phillips screwdriver, remove the three screws from the printer cover. Remove the cover.
5. Note the orientation of the exposed printed wiring board and the paper roll arm assembled on the printer door. Remove the paper roll arm from the clips.
6. GENTLY lift the printed wiring board upwards and away from the printer door. The paper drive mechanism on the underside of the wiring board is now exposed.
7. Using a pair of tweezers or fine needle-nosed pliers, CAREFULLY remove the jammed paper from the mechanism.
8. Place the printed wiring board back into position on the printer door. Note the alignment of the mounting holes in the wiring board and the mounting posts on the printer door. The black plastic printer body rests between the locating ribs on the inside of the printer door.
9. Carefully snap the paper roll holder, in the loading position, back into the clips on the printer door.
10. Place the printer cover on the printer door. Check to be sure that the flexible cables are not pinched between the cover and the door. The white power button and the black paper advance button must protrude through the openings in the cover and operate freely.
11. Using a Phillips screwdriver, secure the printer cover to the printer door with the three screws removed during disassembly.
12. Plug your Statim in and turn on the main power switch.
13. Press in the white printer power button. Load paper into the printer and run a test cycle.

**Part Numbers**

<b>Statim 2000 Parts</b>		<b>Statim 5000 Parts</b>	
01-100207S	Air Filter	01-101652S	Air Compressor Filter
01-103469S	Allen Key 9/64	01-103469S	Allen Key 9/64
01-100561S	Armature	01-101623S	Armature
01-102119S	Biological Filter	01-102119S	Biological Filter
01-104284S	Biological Filter Bracket	01-104284S	Biological Filter Bracket
01-108979S	Boiler Alex 5XX software (for 4XX or lower software needs Alex Boiler Kit shop repair only)	01-108980S	Boiler Alex 5XX software (for 4XX or lower software needs Alex Boiler Kit shop repair only)
01-100684S	Bubble Level	01-100684S	Bubble Level
01-100780S	Bumper	01-100780S	Bumper
01-100008A	Cassette Complete	01-101613S	Cassette Complete
01-100834S	Cassette Lid	01-101658S	Cassette Handles
01-100028S	Cassette Seal & Lube Kit	01-101757S	Cassette Lid
01-103475S	Cassette Tray Only	01-101649S	Cassette Seal & Lube Kit
01-100271A	Cassette Tray W/Rack	01-101614S	Cassette Tray W/Rack
01-100574S	Check Valve	01-101627S	Check Valve
01-100560S	Compressor	01-101619S	Compressor
01-103139S	Conductivity Meter (Water Tester)	01-103139S	Conductivity Meter (Water Tester)
01-109128S	Copper Tubing Kit 2000	01-109129S	Copper Tubing Kit 5000
01-100564S	Cover Complete (Model 101102)	01-104300S	Cover Complete
01-106121S	Cover Complete (Model 01-121101)	01-101625S	Cover W/O Facia
01-101611S	Cover W/O Facia	74-100335A	Drain Tube 1"
74-100335A	Drain Tube 1"	01-100204S	Exhaust Tubing
01-108152S	Drain Tube Kit	01-104299S	Facia Complete
01-100204S	Exhaust Tubing	01-101650S	Facia Gasket
01-100563S	Facia Complete (Model 101102)	01-103472S	Fuse 15A (Qty 2)
01-106122S	Facia Complete (Model 01-121101)	01-103497S	Fuse .25A
01-100842S	Facia Gasket	01-103498S	Fuse 2A
01-103518S	Facia W/O LCD (Model 101102)	01-103857S	Isoplate
01-106124S	Facia W/O LCD (Model 01-121101)	01-109671S	Keypad
01-107817S	Fitting 3/8" Biological Filter Tube	01-104382S	LCD
01-100472S	Fuse 15A (Qty 2)	01-101553S	Leveler
01-103497S	Fuse .25A	01-104180S	Leveler Repair Kit
01-103498S	Fuse 2A	01-106087S	Line Filter
01-103856S	Isoplate	01-108746S	Microprocessor 4XX 5000 USA
01-101707S	Keypad (Model 101102)	01-108978S	Microprocessor 5XX Alex 5000 USA
01-109680S	Keypad (Model 01-121101)	01-101621S	Microswitch
01-104381S	LCD (Includes Decal)	01-108415S	Packaging (Carton Only)
01-106950S	LCD Decal	01-108327S	Packaging (w/Inserts)
01-101553S	Leveler	01-109827S	PCB Rev 7 Kit includes Alex Boiler
01-104180S	Leveler Repair Kit	01-109395S	PCB Rev 7 must have Alex Boiler in unit
01-106087S	Line Filter	01-108777S	PCB Adapter Board 4XX 5000 USA
01-108742S	Microprocessor 4XX 2000	01-108987S	PCB Adapter Board 5XX 5000 USA
01-108976S	Microprocessor 5XX Alex 2000	01-106350S	PCB Power Cable
01-100571S	Microswitch	01-104343S	Plug Drain Tubing
01-108413S	Packaging (Carton Only)	01-107707S	Power Cable Filter/Switch
01-108348S	Packaging (w/Inserts)	01-101647S	Power Cord
01-109716S	PCB Rev 7 Kit includes Alex Boiler	01-100573S	Power Switch
01-109365S	PCB Rev 7 must have Alex Boiler	01-106787S	Pressure Relief Valve
01-108775S	PCB Adapter Board 4XX 2000	01-210000	Printer
01-108985S	PCB Adapter Board 5XX 2000	01-102159S	Printer Door
01-106349S	PCB Power Cable	01-101657S	Printer Paper (Pkg. 10)
01-104343S	Plug Drain Tubing	01-101973S	Printer Paper Holder
01-107707S	Power Cable Filter/Switch	01-101971S	Printer Spring/Latch
01-100572S	Power Cord (Model 101102)	01-101618S	Probe Bracket

Statim 2000 Parts		Statim 5000 Parts	
01-101647S	Power Cord (Model 01-121101)	01-100865S	Probe Bracket Gasket
01-100573S	Power Switch	01-101761S	Pump
01-106787S	Pressure Relief Valve	01-100713S	Pump Tester Bottle
01-100570S	Probe Bracket	01-101755S	Push In Fitting
01-100865S	Probe Bracket Gasket	01-101709S	Rack Unwrapped (Mesh)
01-100568S	Pump	01-102054S	Rack Wrapped
01-108363S	Pump Bracket	01-101622S	Reservoir
01-104501S	Pump Filter Kit (Qty 2)	01-101783S	Reservoir Cap
01-100713S	Pump Tester Bottle	01-104303S	Solenoid Coil
01-100783S	Push In Fitting	01-103471S	Solenoid Plunger Wrench
01-103945S	Rack Unwrapped	01-101628S	Solenoid Valve Complete
01-106653	Rack Wrapped (Mesh)	01-100998S	Solenoid Valve Repair Kit
01-101783S	Reservoir Cap	01-108981S	Temperature Adapter Board
01-100565S	Reservoir w/Float	01-104462S	Thermal Fuse
01-103107S	Reservoir w/Water Quality Sensor	01-108984S	Validation Thermocouple
01-104303S	Solenoid Coil	01-100812S	Waste Bottle Complete
01-103471S	Solenoid Plunger Wrench	01-100735S	Waste Bottle Fitting
01-100557S	Solenoid Valve Complete	01-100724S	Waste Bottle Only
01-100998S	Solenoid Valve Repair Kit	01-103571S	Water Quality Sensor
01-108981S	Temperature Adapter Board		
01-104461S	Thermal Fuse		
01-108983S	Validation Thermocouple 2000		
01-100812S	Waste Bottle Complete		
01-100735S	Waste Bottle Fitting		
01-100724S	Waste Bottle Only		
01-103571S	Water Quality Sensor		

### Statim Specifications

Statim 2000	Statim 5000
External Size (LgthxWdthxHgth)	External Size (LgthxWdthxHgth)
17 3/4" x 16 1/4" x 6"	21 3/4" x 16 1/4" x 7 1/2"
Cassette Internal Dimensions	Cassette Internal Dimensions
11" x 7" x 1 1/2"	15" x 7" x 3"
Reservoir Capacity	Reservoir Capacity
4 Liters	4 Liters
Approximately 40 Cycles	Approximately 20 Cycles
Weight Without Water	Weight Without Water
46 Pounds	72 Pounds
Power Consumption	Power Consumption
1300 Watts	1300 Watts
Printer	Printer
Not Available	Type: Thermal Paper
	Print: 20 Characters Per Line
	Speed: 1 Line Per Second
	Capacity: 80 Cycles Per Roll
Cycle Time	Cycle Time
Unwrapped: 6 Minutes	Unwrapped: 9 Minutes
Wrapped: 12-15 Minutes	Wrapped: 15-18 Minutes
Rubber & Plastics: 20 Minutes	Rubber & Plastics: 40 Minutes
	Heavy Duty Unwrap: 12 Minutes
Warranty	Warranty
1 Year Parts (Excluding Seal)	1 Year Parts (Excluding Seal)
1 Year SciCan Labor	1 Year SciCan Labor

## Statim 2000 Front View

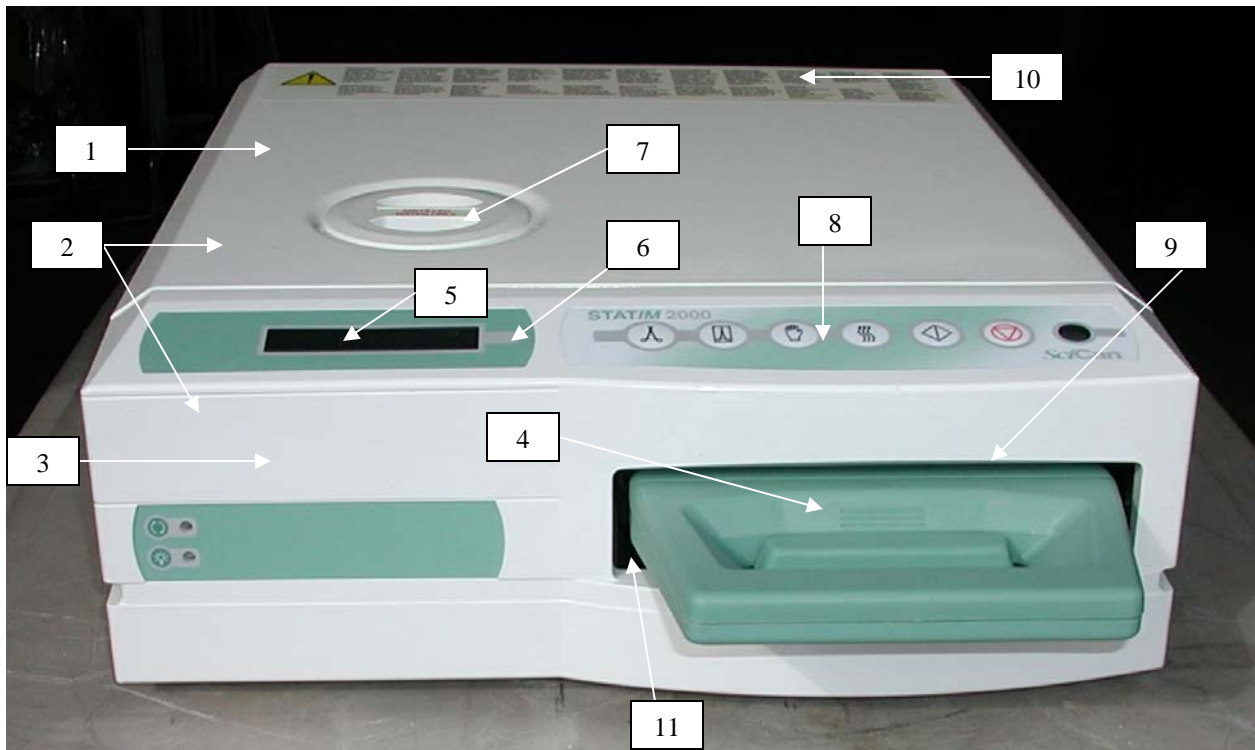

Item #	Part #	Description
1	01-101611S	Cover without Facia
2	01-100564S	Cover Complete for Model 101102
2	01-106121S	Cover Complete for Model 01-121101
3	01-100563S	Facia Complete for Model 101102
3	01-106122S	Facia Complete for Model 01-121101
3	01-103518S	Facia without LCD for Model 101102
3	01-106124S	Facia without LCD for Model 01-121101
4	01-100008S	Cassette Complete
5	01-104381S	LCD includes Decal (located inside Facia)
6	01-106950S	LCD Decal Only
7	01-101783S	Reservoir Cap
8	01-101707S	Keypad (old style not shown)
8	01-109680S	Keypad (pictured above)
9	01-100842S	Facia Gasket (not shown located inside Facia)
10	01-106675S	Label Kit Qty 10
11	01-103856S	Isoplate (not shown, not field replaceable requires alignment jig)

## Statim 2000 Rear View

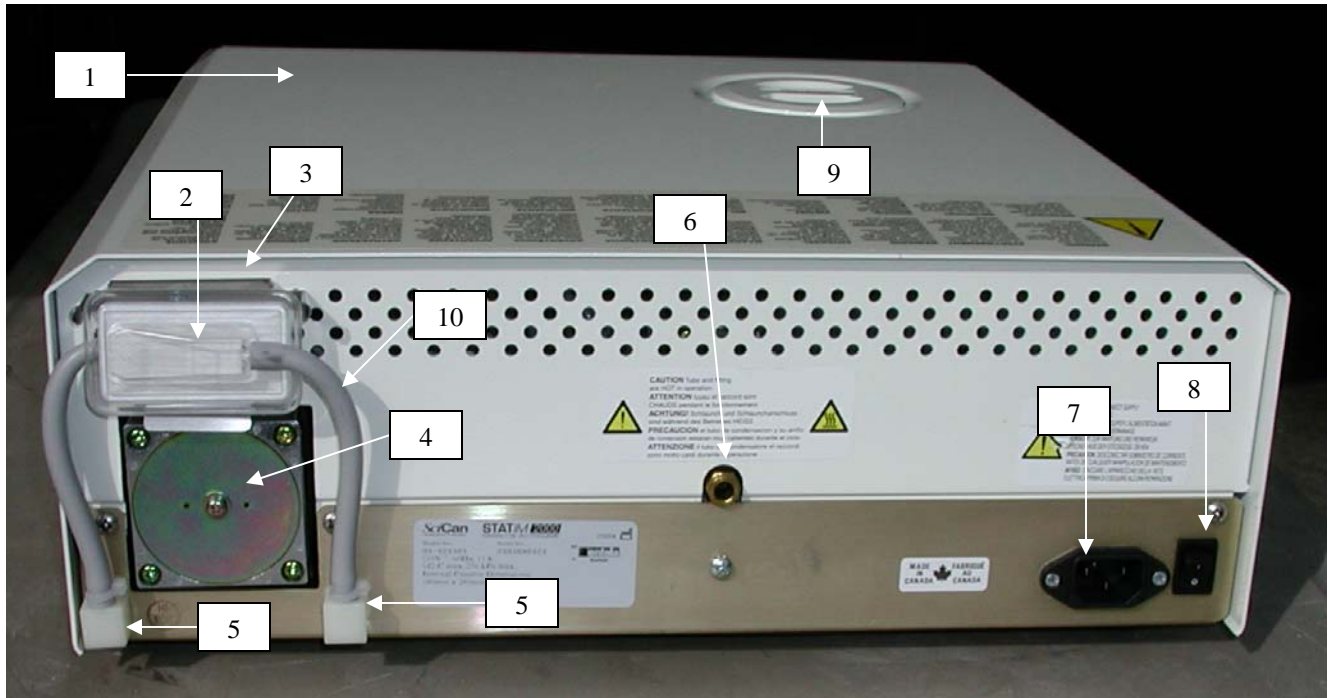

Item #	Part #	Description
1	01-100564S	Cover Complete (Model #101102)
1	01-106121S	Cover Complete (Model #01-121101)
2	01-102119S	Biological Filter (not on all units)
3	01-104284S	Biological Filter Bracket (behind Biological Filter)
4	01-100207S	Air Filter (Behind Cover on Air Compressor)
5	01-107817S	Fitting 3/8" for Biological Filter Tubes (Pkg. of 2)
6	01-100782S	Push In Fitting
7	01-106087S	Line Filter
8	01-100573S	Power Switch
9	01-101783S	Reservoir Cap
10	01-108434S	Drain Tube Extended (Gray Hose)

## Statim 2000 Bottom View

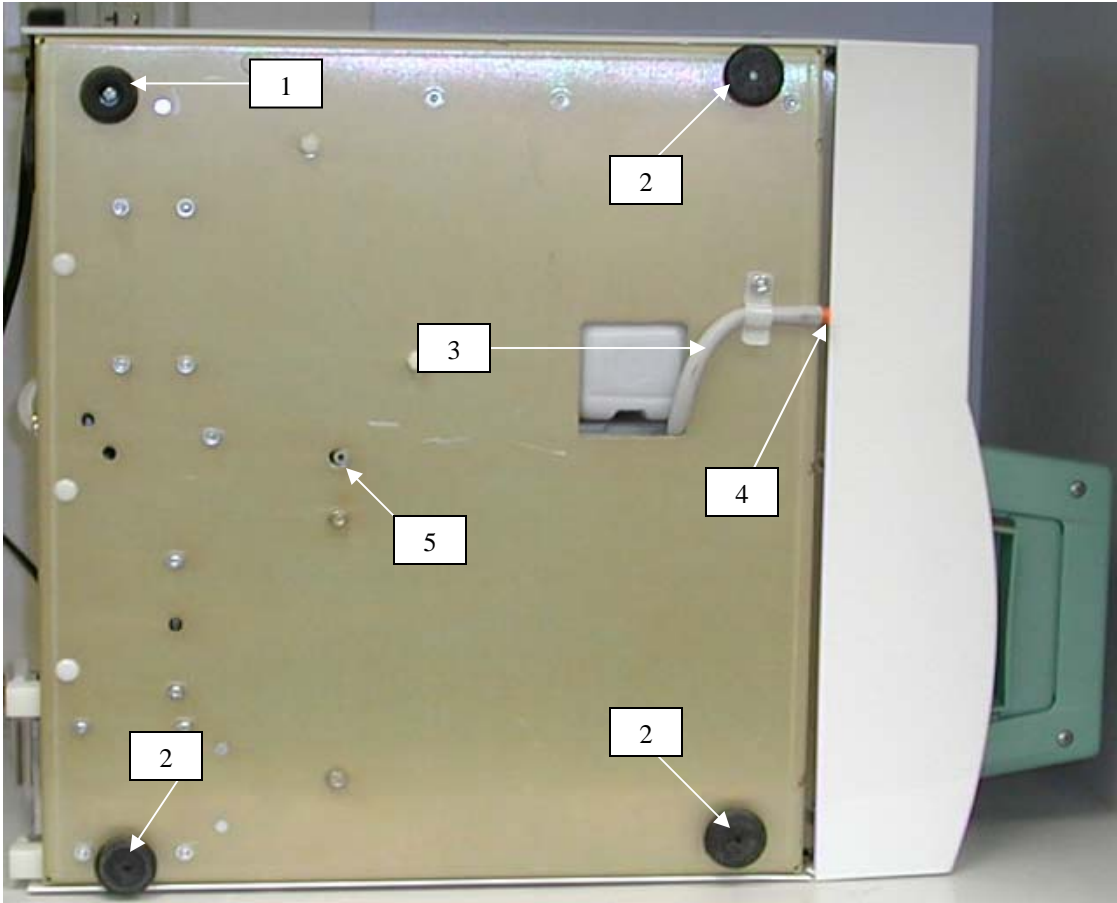

Item #	Part #	Description
1	01-100780S	Bumper
2	01-101553S	Leveler
2	01-104180S	Leveler Repair Kit (includes Leveler and Insert for Leveler)
3	01-108152S	Drain Tubing Kit
4	01-104343S	Plug Drain Tubing
5	74-100335A	Drain Tube 1"



**Statim 2000 Revision 4XX & Lower Software Top View No Cover**

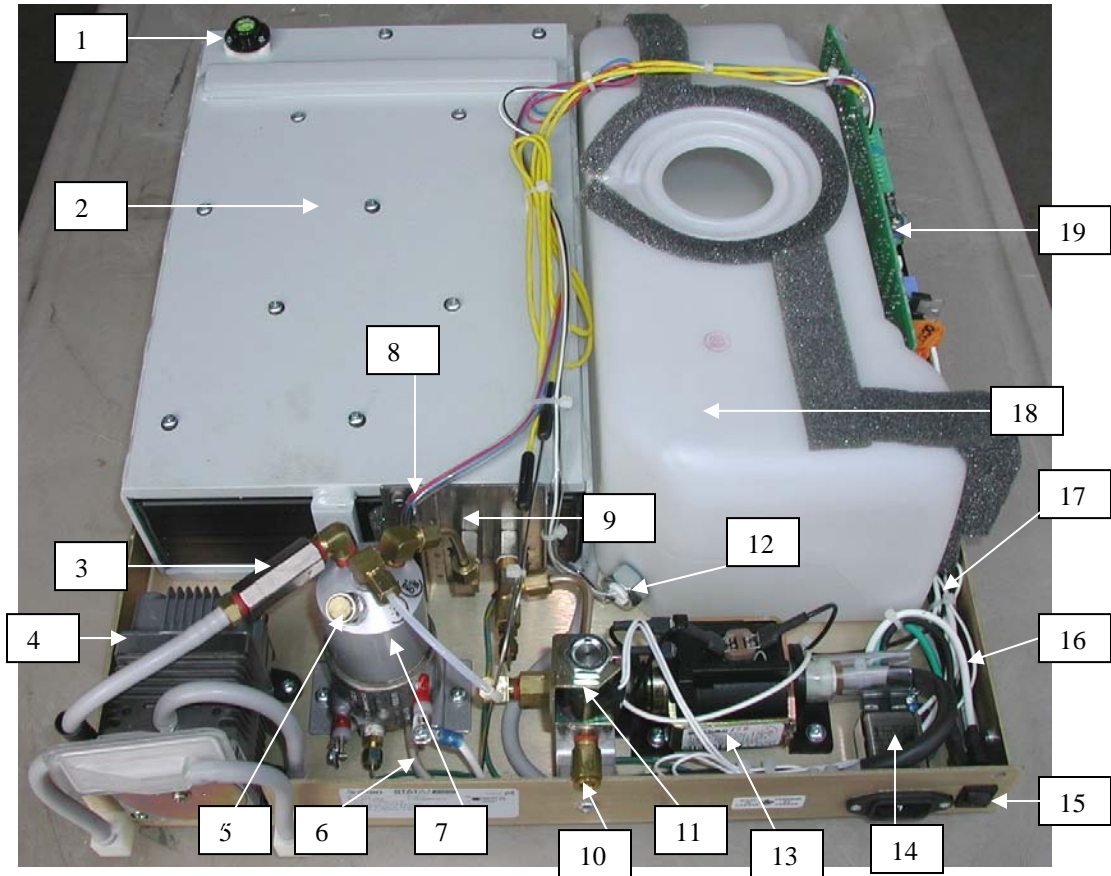

Item #	Part #	Description
1	01-100684S	Bubble Level
2	01-100561S	Armature (not field replaceable requires alignment jig)
3	01-100574S	Check Valve
4	01-100560S	Compressor
5	01-106787S	Pressure Relief Valve
6	01-104461S	Thermal Fuse (not shown, under Boiler)
7		Boiler (must have 5XX or higher software to replace in field)
8	01-100571S	Microswitch (not shown, behind Boiler)
9	01-100570S	Probe Bracket (not field replaceable requires calibration)
10	01-100782S	Push In Fitting
11	01-100557S	Solenoid
12	01-103571S	Water Quality Sensor
13	01-100568S	Pump
14	01-106087S	Line Filter
15	01-100573S	Power Switch
16	01-107707S	Power Cable Filter/Switch
17	01-106349S	PCB Power Cable
18	01-103107S	Reservoir with Water Quality Sensor
18	01-100565S	Reservoir with Float Switch
19	01-109365S	PCB Revision 7 must have Alex Boiler in Statim (see note)
19	01-109716S	PCB Revision 7 Kit includes Alex Boiler (see note)
<b>Note: PCB is not field replaceable requires chamber and boiler calibration</b>		

## Statim 2000 Revision 5XX & Higher Software Alex Parts

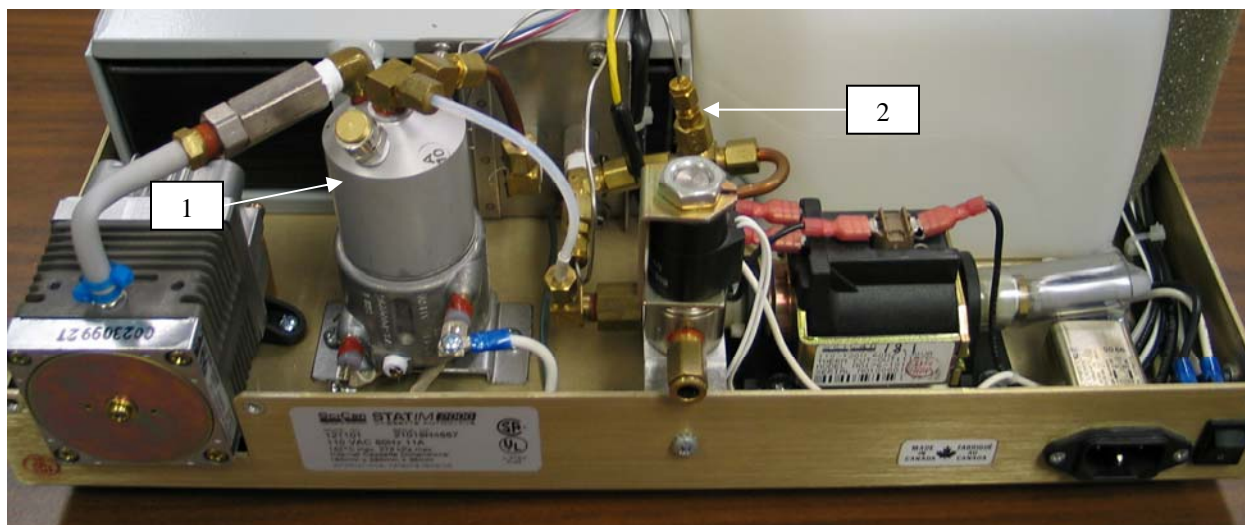

Item #	Part #	Description
1	01-108979S	Boiler Alex 2000 Revision 5XX & Higher Software
2	01-108983S	Validation Thermocouple 2000

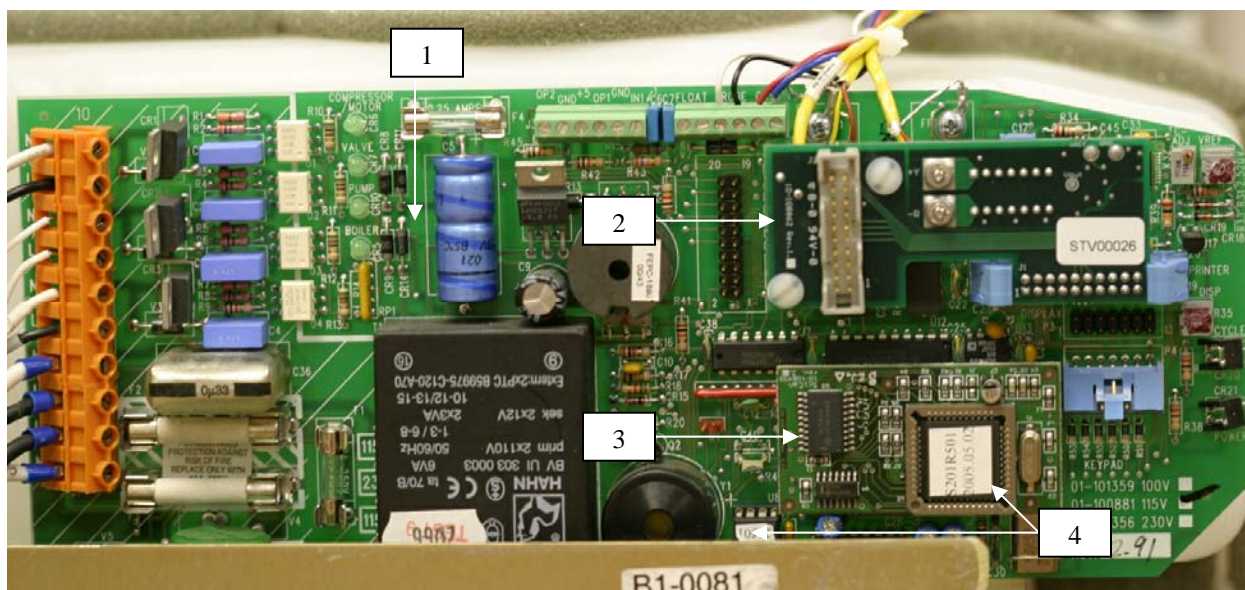

Item #	Part #	Description
1	01-109365S	PCB Revision 7 must have Alex Boiler in Statim
2	01-108981S	Temperature Adapter Board for Alex
3	01-108985S	PCB Adapter Board Revision 5XX Software Alex 2000
4	01-108976S	Microprocessor Kit Revision 5XX Software Alex 2000
<b>Note: PCB is not field replaceable requires chamber and boiler calibration</b>		

### Statim 5000 Front View

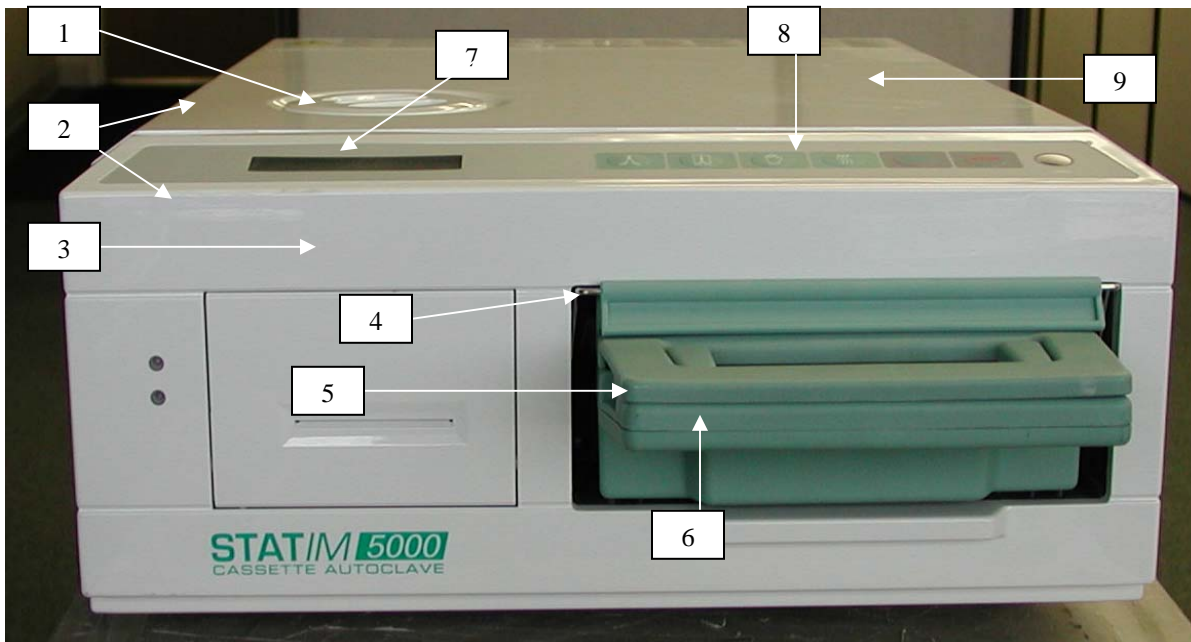

Item #	Part #	Description
1	01-101783S	Reservoir Cap
2	01-104300S	Cover Complete
3	01-104299S	Facia Complete
4	01-101650S	Facia Gasket (not shown located inside Facia)
5	01-101613S	Cassette Complete
6	01-103857S	Isoplate (not shown, not field replaceable requires alignment jig)
7	01-104382S	LCD (located inside Facia)
8	01-109671S	Keypad
9	01-101625S	Cover without Facia

## Statim 5000 Rear View

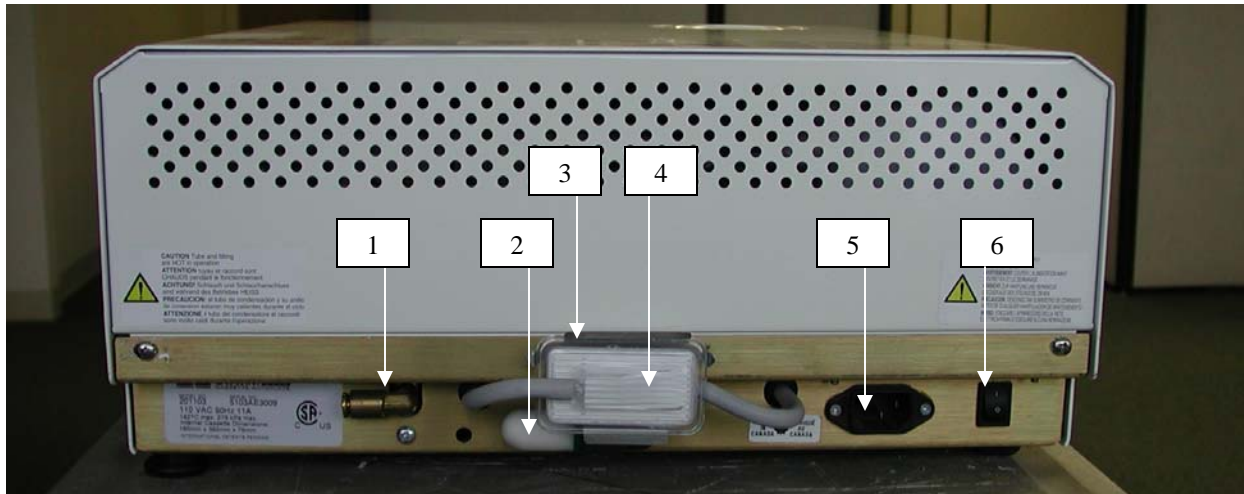

Item #	Part #	Description
1	01-101755S	Push In Fitting
2	01-101652S	Air Compressor Filter (not on all units)
3	01-104284S	Biological Filter Bracket
4	01-102119S	Biological Filter
5	01-103993S	Power Socket (older units)
5	01-106087S	Line Filter (newer units)
6	01-100573S	Power Switch



## 5000 Parts Top View No Cover

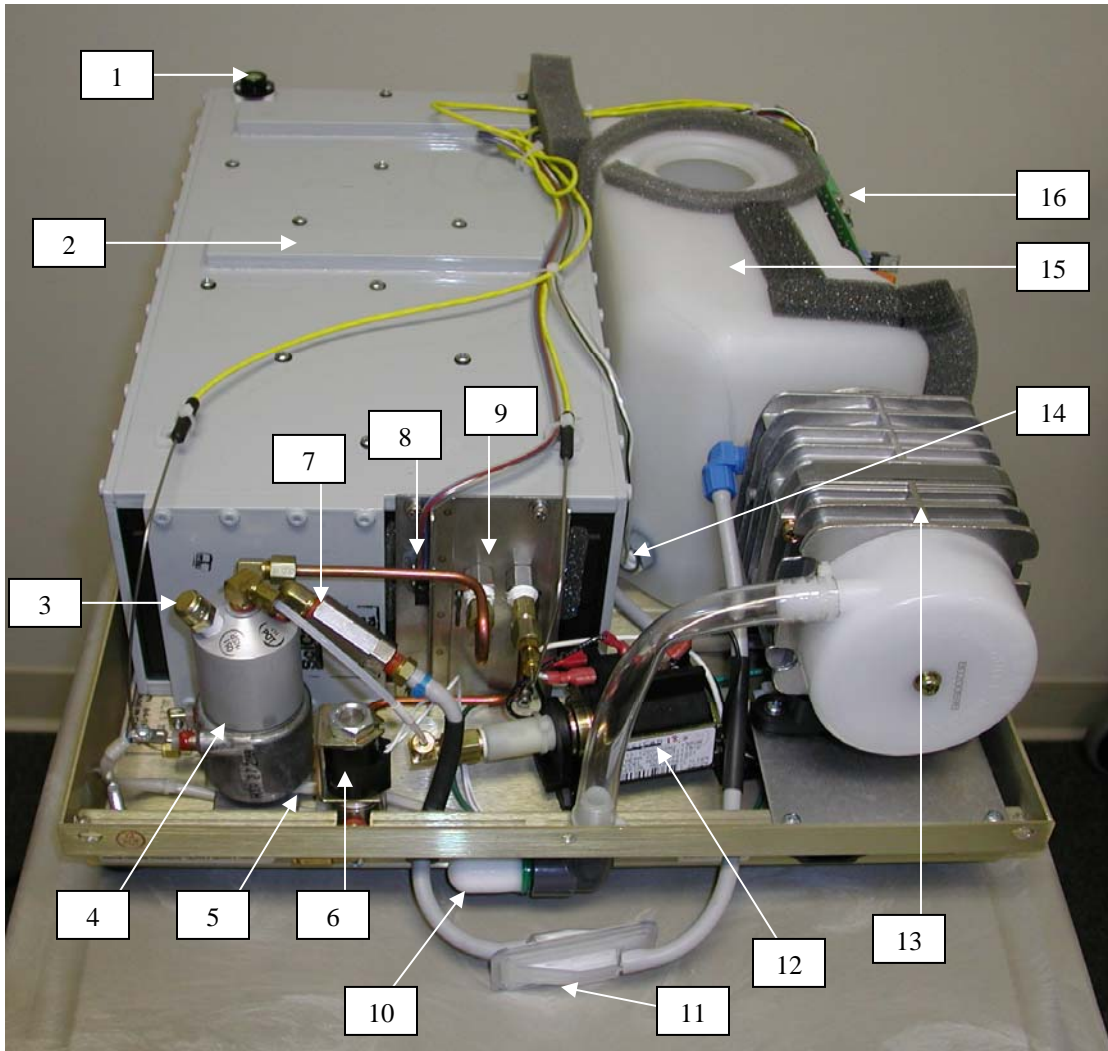

Item #	Part #	Description
1	01-100684S	Bubble Level
2	01-101623S	Armature (not field replaceable requires alignment jig)
3	01-106787S	Pressure Relief Valve
4		Boiler (must have 5XX or higher software to replace in field)
5	01-104462S	Thermal Fuse (not shown, under boiler)
6	01-101628S	Solenoid
7	01-101627S	Check Valve
8	01-101621S	Microswitch
9	01-101618S	Probe Bracket (not field replaceable requires calibration)
10	01-101652S	Air Compressor Filter (not on all units)
11	01-102119S	Biological Filter
12	01-101761S	Pump
13	01-101619S	Compressor
14	01-103571S	Water Quality Sensor
15	01-101622S	Reservoir
16	01-109395S	PCB Revision 7 must have Alex Boiler in Statim (see note)
16	01-109827S	PCB Revision 7 Kit includes Alex Boiler (see note)
<b>Note: PCB is not field replaceable requires chamber and boiler calibration</b>		

## Statim 5000 Revision 5XX & Higher Software Alex Parts

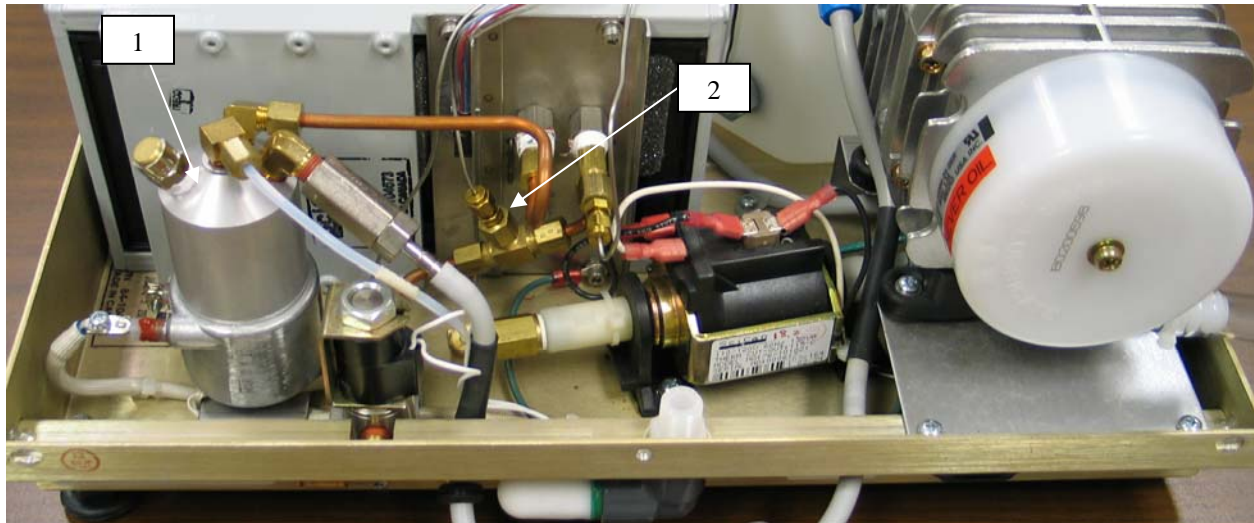

Item #	Part #	Description
1	01-108980S	Boiler Alex 5000 Revision 5XX & Higher Software
2	01-108984S	Validation Thermocouple 5000

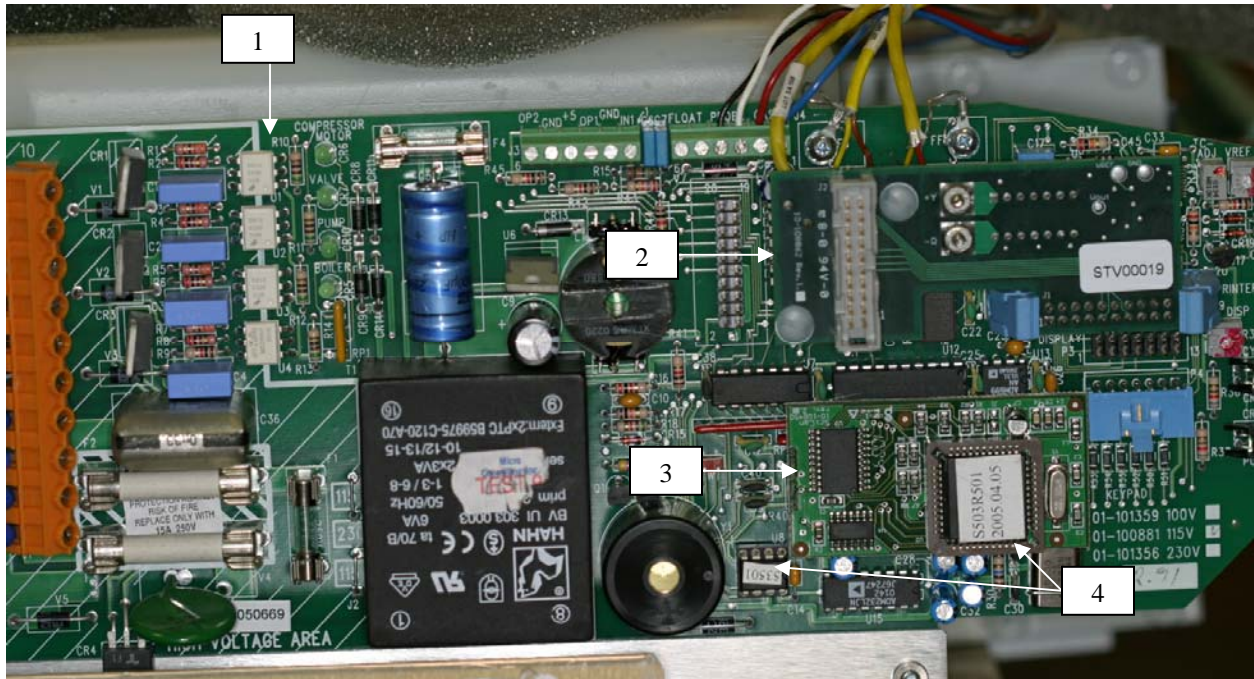

Item #	Part #	Description
1	01-109045S	PCB Alex 5000 Revision 5XX & Higher Software (see note)
2	01-108981S	Temperature Adapter Board for Alex
3	01-108987S	PCB Adapter Board Alex 5000 5XX Software
4	01-108978S	Microprocessor Kit Alex 5000 Revision 5XX Software
<b>Note: PCB is not field replaceable requires chamber and boiler calibration</b>		

## Statim 900 Error Codes

### Cycle Fault 1

**The chamber temperature failed to reach 102°C within a time-out period.**

1. Boiler does not heat up. No power to boiler. Field Service Tech. repair
2. Check thermal fuse. Using an ohmmeter check for continuity between J1-3 & lower terminal on boiler. If you read less than 1-ohm thermal fuse is good. If thermal fuse is good proceed to step 3, if bad replace and check unit for proper operation. Test pump using pump tester. Field Service Tech. repair
3. Check resistance reading between J1-3 & J1-4 should read approx. 11 ohms. Field Service Tech. repair
4. Check for line voltage at terminals J1-3 & J1-4 during warm up. If the reading is good proceed to step 5, if bad, PCB (Printed Circuit Board) is defective. Shop repair
5. An extremely large steam leak. Replace chamber seal. End user or Field Service Tech. repair

### Cycle Fault 2 N/A

### Cycle Fault 3

**The chamber has failed to pressurize and achieve a temperature of 110°C within a time-out period.**

1. If visible steam leaks appear replace chamber seal. End user or Field Service Tech. repair
2. If no leaks are visible disassemble solenoid valve and check for debris. Make sure plunger slides smoothly in plunger tube. Field Service Tech. repair

### Cycle Fault 4

**The chamber has failed to achieve sterilization conditions within 6 minutes of the chamber first reaching 110°C.**

1. If visible steam leaks appear replace chamber seal. End user or Field Service Tech. repair
2. If no leaks are visible disassemble solenoid valve and check for debris. Make sure plunger slides smoothly in plunger tube. Field Service Tech. repair

### Cycle Fault 5 N/A

### Cycle Fault 6

**The software has detected a steam generator (boiler) temperature 5°C greater than the chamber, within 7.2 seconds after a purge during the sterilizing phase of a cycle.**

1. Check exhaust seal screen, clean or replace as needed. End user repair
  2. Calibrate boiler. If problem persists replace and calibrate boiler. Field Service Tech. repair
- DO NOT clean boiler with CLR.**

### Cycle Fault 7 N/A

### Cycle Fault 8

**The software has detected a steam generator (boiler) temperature 5°less than the chamber, within 7.2 seconds after a purge during the sterilizing phase of a cycle.**

1. Calibrate boiler. If problem persists replace and calibrate boiler. Field Service Tech. repair

### Cycle Fault 9-10 N/A

### Cycle Fault 11

**The chamber temperature has failed to drop to 102°C within 60 seconds of the end of a cycle during venting.**

1. Check for kinked or pinched exhaust tubing. End user repair
2. Check exhaust seal screen, clean or replace as needed. End user repair
3. Solenoid valve is failing to open. Disassemble and check that plunger slides smoothly in plunger tube. Field Service Tech. repair
4. Check for power to solenoid. Using a voltmeter check for line voltage at terminals J1-7 & J1-8 while the unit is warming up. If line voltage is present check for a magnetic field above the solenoid coil. The solenoid coil has a bridge rectifier built into it. To check the coil put your meter on the diode checking scale and read the resistance of the coil, then reverse the leads, the resistance should be approximately the same in both directions. Field Service Tech. repair

## Statim 900 Error Codes

### Cycle Fault 12

**This indicates a problem with the temperature measuring system.**

1. Check thermocouples, they should read approximately 10 ohms at room temperature. Shop repair

### Cycle Fault 13-14 N/A

### Cycle Fault 15

**The chamber temperature rose above the limit temperature 140°C.**

1. Check for kinked or pinched exhaust tubing. End user repair
2. Solenoid valve is failing to open. Disassemble and check that plunger slides smoothly in plunger tube. Field Service Tech repair
3. Calibrate boiler. Field Service Tech. Repair

### Cycle Fault 16

**The steam generator (boiler) temperature went above 171°C during the heat up phase of a cycle.**

1. Check pump using the Pump Tester Bottle. Field Service Tech. repair
2. If pump tests weak, clean the pump filters. Field Service Tech. repair
3. Calibrate boiler when pump is functioning properly. Field Service Tech. repair

### Cycle Fault 17-18 N/A

### Cycle Fault 19

**The steam generator (boiler) calibration is invalid. A new calibration is required.**

1. Calibrate the boiler. If problem persists replace microprocessor and calibrate boiler. Field Service Tech. repair

### Cycle Fault 20

**The pump has failed to pump water into the steam generator (boiler) during a pre-vent pump time-out. The steam generator (boiler) temperature was greater than 140°C for 3.6 seconds after the pump was activated to pump water to cool the steam generator (boiler).**

1. Check pump using the Pump Tester Bottle. Field Service Tech. repair
2. If pump tests weak, clean the pump filters. Field Service Tech. repair
3. Calibrate boiler when pump is functioning properly. Field Service Tech. repair

### Cycle Fault 21-24 N/A

### Cycle Fault 25

**The software has failed to detect a need to pump water in 90 seconds of the start of the cycle or the last time the pump was activated.**

1. Boiler does not heat up. No power to boiler. Field Service Tech. repair
2. Check thermal fuse. Using an ohmmeter check for continuity between J1-3 & lower terminal on boiler. If you read less than 1-ohm thermal fuse is good. If thermal fuse is good proceed to step 3, if bad replace and check unit for proper operation. Test pump using pump tester. Field Service Tech. repair
3. Check resistance reading between J1-3 & J1-4 should read approx. 11 ohms. Field Service Tech. repair
4. Check for line voltage at terminals J1-3 & J1-4 during warm up. If the reading is good proceed to step 5, if bad, PCB (Printed Circuit Board) is defective. Shop repair
5. Check for line voltage at boiler terminals. Field Service Tech. repair

### Cycle Fault 26

**The chamber and steam generator (boiler) temperatures were 2°C apart for at least 10 seconds during sterilization.**

1. Check exhaust seal screen, clean or replace as needed. End user repair
2. Calibrate boiler. If problem persists replace and calibrate boiler. Field Service Tech. repair



## Statim 900 Error Codes

### Cycle Fault 27

**The pump failed to cool the steam generator (boiler) to below 155°C for 6 seconds.**

1. Check pump using the Pump Tester Bottle. Field Service Tech. repair
2. If pump tests weak, clean the pump filters. Field Service Tech. repair
3. Calibrate boiler when pump is functioning properly. Field Service Tech. repair

### Cycle Fault 29

**The pump failed to cool the steam generator (boiler) to the target temperature during the first pump of the cycle.**

1. Check pump using the Pump Tester Bottle. Field Service Tech. repair
2. If pump tests weak, clean the pump filters. Field Service Tech. repair
3. Calibrate boiler when pump is functioning properly. Field Service Tech. repair

### Cycle Fault 30

**The chamber and steam generator (boiler) temperatures did not stabilize within 2°C of one another within 30 seconds of the chamber reaching sterilization temperature.**

1. Check exhaust seal screen, clean or replace as needed. End user repair
2. Calibrate boiler. If problem persists replace and calibrate boiler. Field Service Tech. repair

### Cycle Fault 50

**During the Rubber and Plastics cycle, the chamber temperature dropped 4°C below the sterilization temperature, allowing for measurement error.**

1. Check exhaust seal screen, clean or replace as needed. End user repair
2. Calibrate boiler. If problem persists replace and calibrate boiler. Field Service Tech. repair

### Cycle Fault 51

**During the Rubber and Plastics cycle, the chamber temperature rose more than 4°C above the sterilization temperature, allowing for measurement error.**

1. Check pump using the Pump Tester Bottle. Field Service Tech. repair
2. If pump tests weak, clean the pump filters. Field Service Tech. repair
3. Calibrate boiler when pump is functioning properly. Field Service Tech. repair

### Cycle Fault 60

**During a cycle at 132°C, the chamber temperature dropped 4°C below the sterilization temperature, allowing for measurement error.**

1. Check exhaust seal screen, clean or replace as needed. End user repair
2. Calibrate boiler. If problem persists replace and calibrate boiler. Field Service Tech. repair

### Cycle Fault 61

**During a cycle at 132°C, the chamber temperature rose more than 4°C above the sterilization temperature, allowing for measurement error.**

1. Calibrate boiler. If problem persists replace and calibrate boiler. Field Service Tech. repair

## Changing the Statim 900 Chamber Seal

**THE METAL PARTS OF THE DRAWER ASSEMBLY AND ITS CONTENTS MAY BE HOT. HOT STEAM WILL ESCAPE FROM THE DRAWER IF THE UNIT HAS BEEN OPERATING. GUARD AGAINST BURNS.**

1. Carefully remove the drawer assembly. The drawer is normally opened using the fourth pad on the keypad while the unit is ON. Without power grasp the sides and bottom of the drawer facia with BOTH hands and slowly pull the drawer forward until it stops. Depress the green door latch, located on the right side of the drawer, and pull the drawer forward until it is free of the unit.
2. The cassette seal assembly is held in place with a thumbscrew on the top surface inside the sterilization chamber. Unscrew the thumbscrew and remove the cassette seal assembly. Note the orientation of the inlet hole on the front right side of the assembly. (If the thumbscrew won't turn, apply gentle force using pliers.)
3. If you are installing a pressure seal/plate kit (part #01-106898S). Proceed to #7.
4. The cassette assembly consists of three parts: the frame, the seal and the plate. Remove the plate from the old seal, then the old seal from the frame. Discard the old seal. Clean the metal parts with water and soap that does not contain chlorine bleach and rinse the parts well.
5. Insert the rounded edge of the new seal into the frame starting at one corner and adjust the seal to fit the frame.
6. Lift the long rubber flap at one end of the seal and insert the plate into the slot. Use your fingers to flex the seal edge back while the plate is inserted. Be patient. It may take a few attempts.
7. Place the assembly so the seal flaps are facing upward, and the inlet hole is located on the front right side of the assembly. Tilt the back of the assembly up to clear the bracket at the back of the armature cap, and press the front of the assembly into the top of the armature cap. The seal assembly should drop down as you remove your hand, if seal assembly drops reinstall the thumbscrew finger tight only to hold seal.
8. Reinstall the drawer. Rest the drawer runners on the rollers located at the chamber opening. Depress the green drawer latch, hold the drawer level and slowly push the drawer forward. Hold the drawer near the center of the drawer facia. As the drawer is inserted, the gear teeth on the drawer runner and the drawer motor gear must engage. If the drawer binds, DO NOT FORCE the drawer. Pull the drawer back a little and then try again. When the teeth are correctly engaged you will feel smooth even resistance while you push.

## Statim 900 Exhaust Seal Cleaning or Replacing

**THE METAL PARTS OF THE DRAWER ASSEMBLY AND ITS CONTENTS MAY BE HOT. HOT STEAM WILL ESCAPE FROM THE DRAWER IF THE UNIT HAS BEEN OPERATING. GUARD AGAINST BURNS.**

1. Carefully remove the drawer assembly.
2. The exhaust seal (part #01-103144S) is a round yellow or black seal in the back left corner of the sterilization chamber. Make note of the orientation of the mesh filter in the seal. Remove the seal with your fingers.
3. Remove the mesh filter from the seal. Clean or replace the mesh filter.
4. If seal is being replaced assemble the mesh filter into the new seal in the groove ensuring that the mesh filter is placed over the thermocouple with the dome oriented upward.
5. Replace the drawer.

### Statim 900 Seal Replacement Illustration

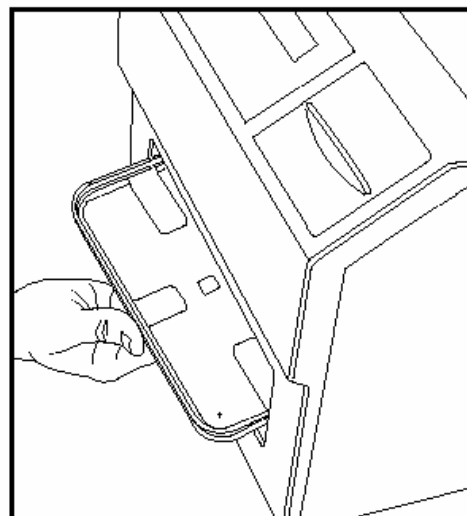
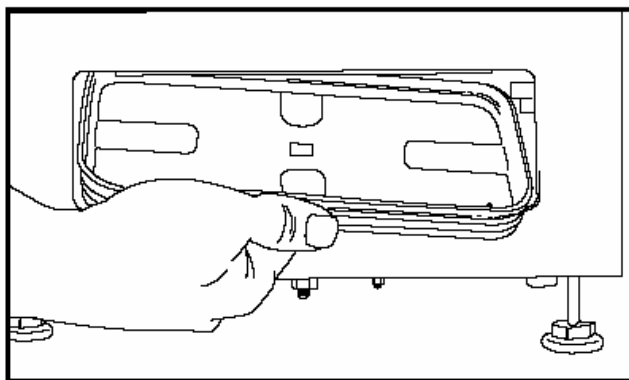
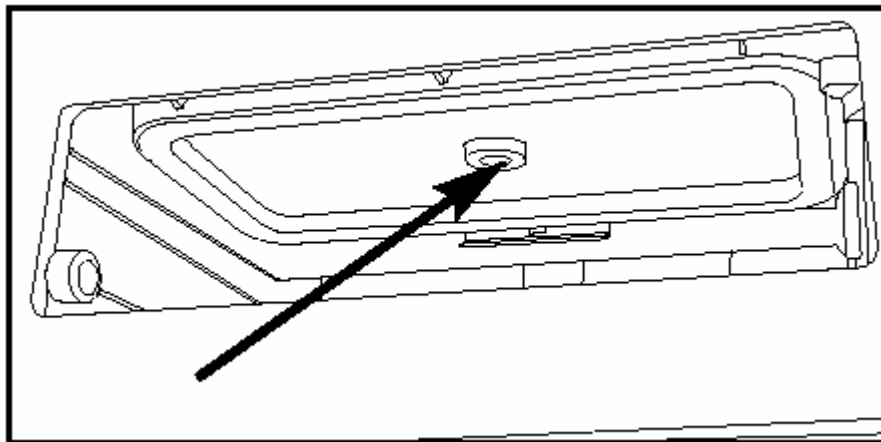
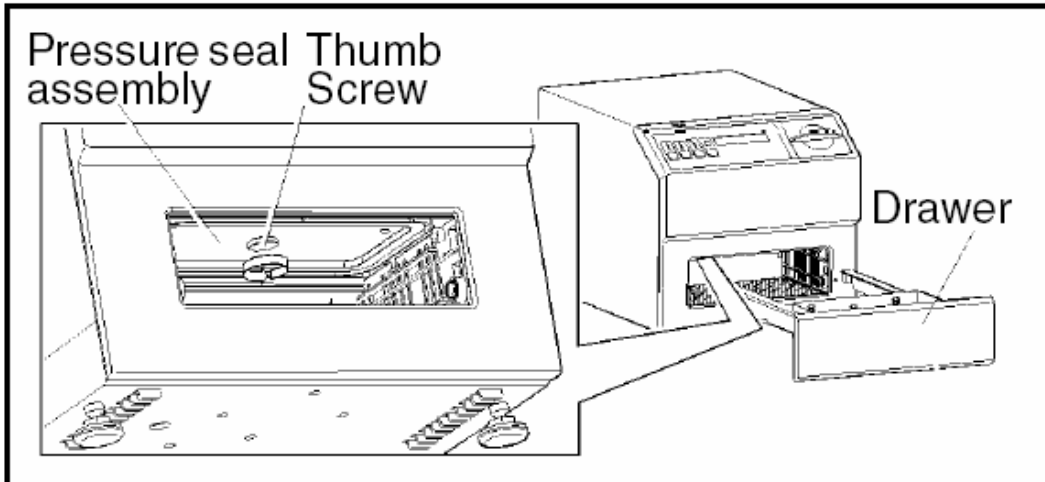

## Selecting the Operating Language on Statim 900

1. Turn the power switch to the OFF position.
2. Press and hold the HANDPIECES button on the keypad. At the same time, turn the power switch, at the rear of the Statim, ON.
3. Press the HANDPIECES button again to scroll to the next language.
4. Press the SOLID INSTRUMENTS button to scroll to the previous language.
5. When the desired language is displayed, press the STOP button to save the selection and return to the regular operating mode.

## Statim 900 Cover Removal and Replacement

### To remove the cover, follow these steps:

1. Unplug the power cord from the unit.
2. Remove two screws from the rear of the unit.
3. Lift the cover up and back to clear the unit.

### To replace the cover, follow these steps:

1. Slide the front of the cover over the unit with a down and forward motion.
2. The front of the cover rests flush with the fascia.
3. Insert two screws to secure the cover.

## Statim 900 Drawer Removal and Replacement

**THE METAL PARTS OF THE DRAWER ASSEMBLY AND ITS CONTENTS MAY BE HOT. HOT STEAM WILL ESCAPE FROM THE DRAWER IF THE UNIT HAS BEEN OPERATING. GUARD AGAINST BURNS.**

The drawer is normally opened using the fourth pad on the keypad while the unit is powered ON. If you are unable to power the unit ON, open the drawer manually.

### To remove the drawer, follow these steps:

With power:

1. Ensure the unit is plugged in and turn the power switch ON.
2. Press the fourth pad on the keypad. The drawer will open and stop.
3. Depress the green drawer latch and pull the drawer forward until it is free of the unit.

Without power:

4. Grasp the sides and bottom of the drawer fascia with BOTH hands and slowly pull the drawer forward until it stops.
5. Depress the green drawer latch and pull the drawer forward until it is free of the unit.

### To install the drawer, follow these steps:

1. Rest the drawer runners on the rollers located at the chamber opening.
2. Depress the green drawer latch, hold the drawer level and slowly push the drawer forward. Hold the drawer near the center of the drawer fascia.
3. As the drawer is inserted, the gear teeth on the drawer runner and drawer motor gear must engage. If the drawer binds, DO NOT FORCE the drawer. Pull the drawer back a little and then try again. When the teeth are correctly engaged you will feel smooth even resistance while you push.

## Statim 900 Sterilization Chamber Removal and Replacement

### To remove the sterilization chamber from the drawer, follow these steps:

1. Remove the drawer from the unit. See removing and installing the drawer.
2. Grasp the top of the chamber near the middle and squeeze.
3. As the walls deflect inward, pull one side up and then the other until the locking tabs are exposed.
4. Once the tabs are exposed, use two hands to work the chamber from the drawer body opening.

### To install the sterilization chamber, follow these steps:

1. Orient the chamber so that the exhaust port is located in the left rear corner of the drawer body opening.
2. Use two hands to press the chamber into the opening, one side first then the other.
3. When the locking tabs reach the drawer body surface, grasp the top of the chamber near the middle and squeeze.
4. As the walls deflect inward, push one side down and then the other until the locking tabs are engaged.

## Boiler Calibration 900

1. Turn the Statim 900 unit OFF and remove the cover. Check to see that the reservoir has distilled water.
2. Short together pins W1 located to the left of the microprocessor on the PCB.
3. Turn the power switch ON. The display should appear similar to the example 1.

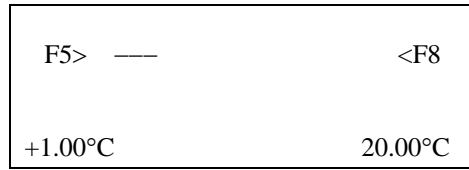

**EXAMPLE 1**

4. To start the boiler (steam generator) self-calibration cycle, press the SOLID INSTRUMENTS cycle button. An asterisk\* will appear beside the message F0. The display should appear similar to example 2. If the asterisk\* does not appear, press the STOP button. Turn the power switch OFF. Short together pins W1 and turn the main power switch ON. Press the SOLID INSTRUMENTS cycle button to start the self-calibration cycle again.

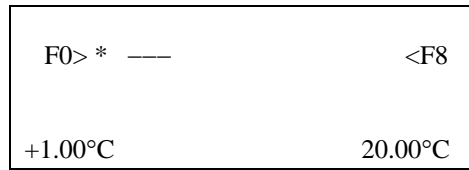

**EXAMPLE 2**

5. As the cycle proceeds, the chamber temperature reaches sterilization temperature, drops to 115°C and then regains sterilization temperature. After 20-40 seconds, a long beep will sound indicating the boiler calibration is complete. The number in the upper left-hand corner of the display has changed to display the new boiler offset value. The display should appear similar to example 3.

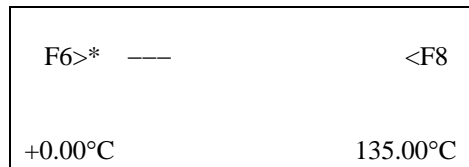

**EXAMPLE 3**

6. Press the STOP button to end the boiler calibration cycle.

### W1 Location

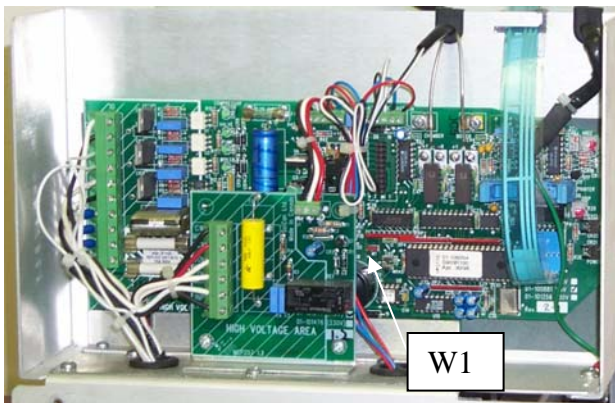

### Solid Instruments Button Location

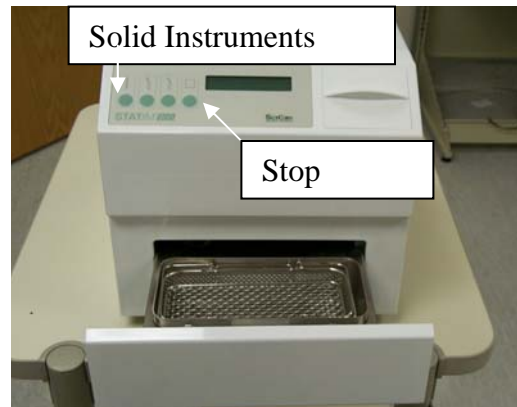

<b>Statim 900 Parts</b>		<b>Statim 900 Specs</b>
01-101556S	Boiler (Steam Generator)	External Size (LgthxWdthxHgh)
01-101554S	Bubble Level	15.1" x 11.5" x 11.1"
01-101582S	Cap Replacement	Chamber Internal Dimensions
01-101558S	Cover	7.5" x 3.54" x 2.1"
01-101562S	Drawer	Reservoir Capacity
01-101560S	Drawer Front	3 Liters
01-100204S	Exhaust Tubing	Weight Without Water
01-103508S	Facia Replacement	29 Pounds
01-106848S	Filter Exhaust Insert	Power Consumption
01-103472S	Fuse 15A (Qty 2)	1300 Watts
01-103497S	Fuse .25A	Printer
01-103498S	Fuse 2A	Not Available
01-103527S	Keypad (Top Overlay)	Cycle Time
01-103138S	LCD	Solid Inst.: 6 Minutes
01-101553S	Leveler	Handpieces: 10 Minutes
01-104180S	Leveler Repair Kit	Rubber & Plastics: 35 Minutes
01-106056S	Microprocessor	Warranty
01-101552S	Microswitch	1 Year Parts (Excluding Seal)
01-101545S	Motor	1 Year SciCan Labor
01-102061S	Motor Control PCB	
01-106052S	Packaging (Box)	
01-106055S	PCB (not field replaceable)	
01-104343S	Plug Drain Tubing	
01-101647S	Power Cord	
01-100573S	Power Switch	
01-103085S	Pressure Relief Valve	
01-102038S	Pump	
01-100713S	Pump Tester Bottle	
01-100782S	Push In Fitting	
01-101542S	Reservoir	
01-103559S	Reservoir Cap	
01-106898S	Seal Assembly Complete W/Plate	
01-103144S	Seal (Exhaust Only)	
01-103143S	Seal (Pressure Only)	
01-101543S	Seal Kit (Pressure & Exhaust)	
01-102064S	Seal Frame	
01-102065S	Seal Plate Flat	
01-102063S	Seal Screw (Thumb Screw)	
01-104303S	Solenoid Coil	
01-103471S	Solenoid Plunger Wrench	
01-101550S	Solenoid Valve Complete	
01-100998S	Solenoid Valve Repair Kit	
01-104461S	Thermal Fuse	
01-100812S	Waste Bottle Complete	
01-100735S	Waste Bottle Fitting	
01-100724S	Waste Bottle Only	
01-106637S	Water Filter In Line	
01-103571S	Water Quality Sensor	

## 900 Parts Front View

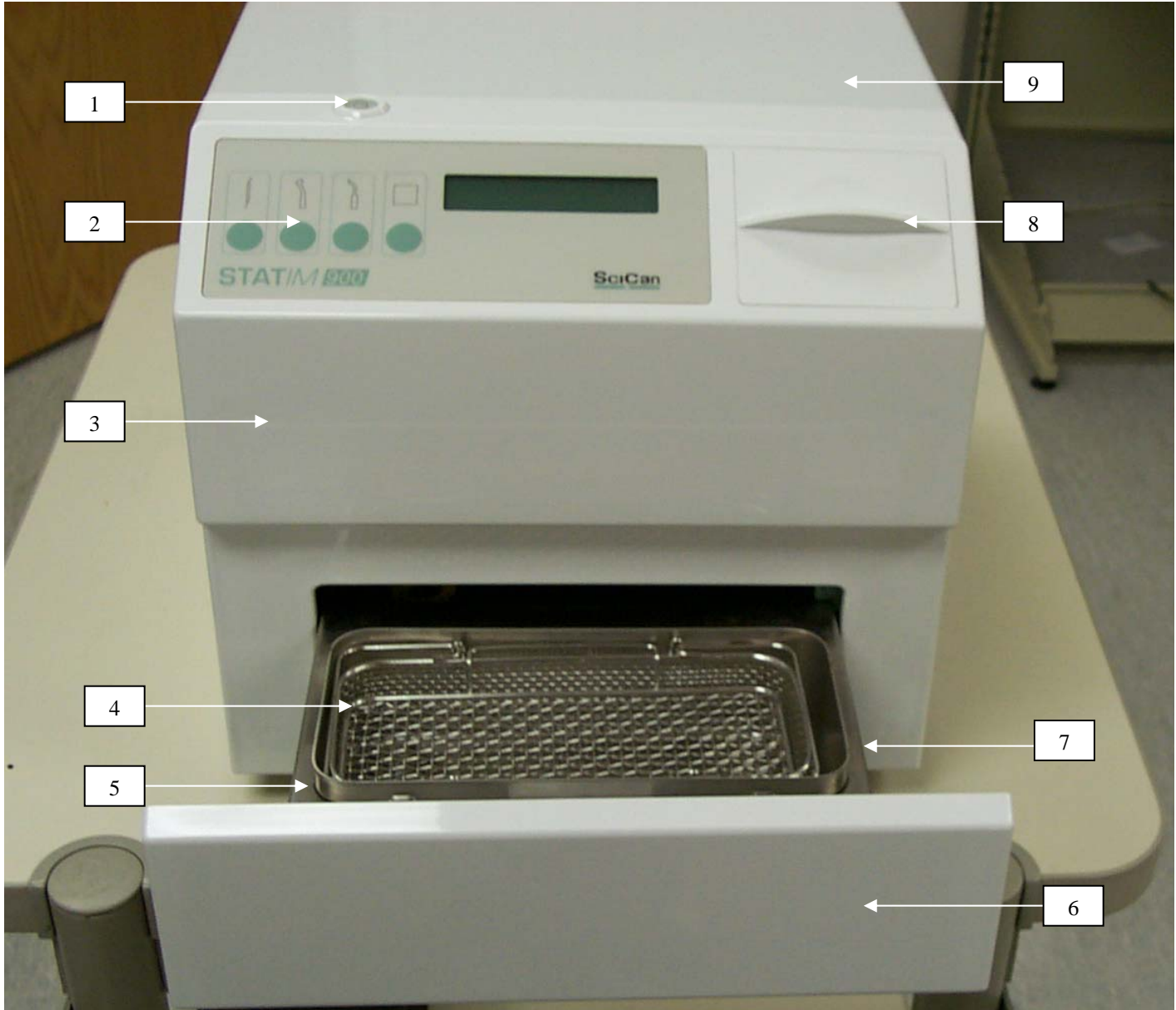

Item #	Part #	Description
1	01-101554S	Bubble Level
2	01-103527S	Keypad
3	01-103508S	Facia
4	01-103636S	Wire Basket W/Insert
5	01-103608S	Sterilization Chamber
6	01-101560S	Drawer Front
7	01-101562S	Drawer
8	01-103559S	Reservoir Cap
9	01-101558S	Cover



## 900 Parts Rear View



Item #	Part #	Description
1	01-104343S	Plug Drain Tubing
2	01-100573S	Power Switch
3	01-106087S	Line Filter
4	01-100782S	Push In Fitting

### 900 Parts Left Side View

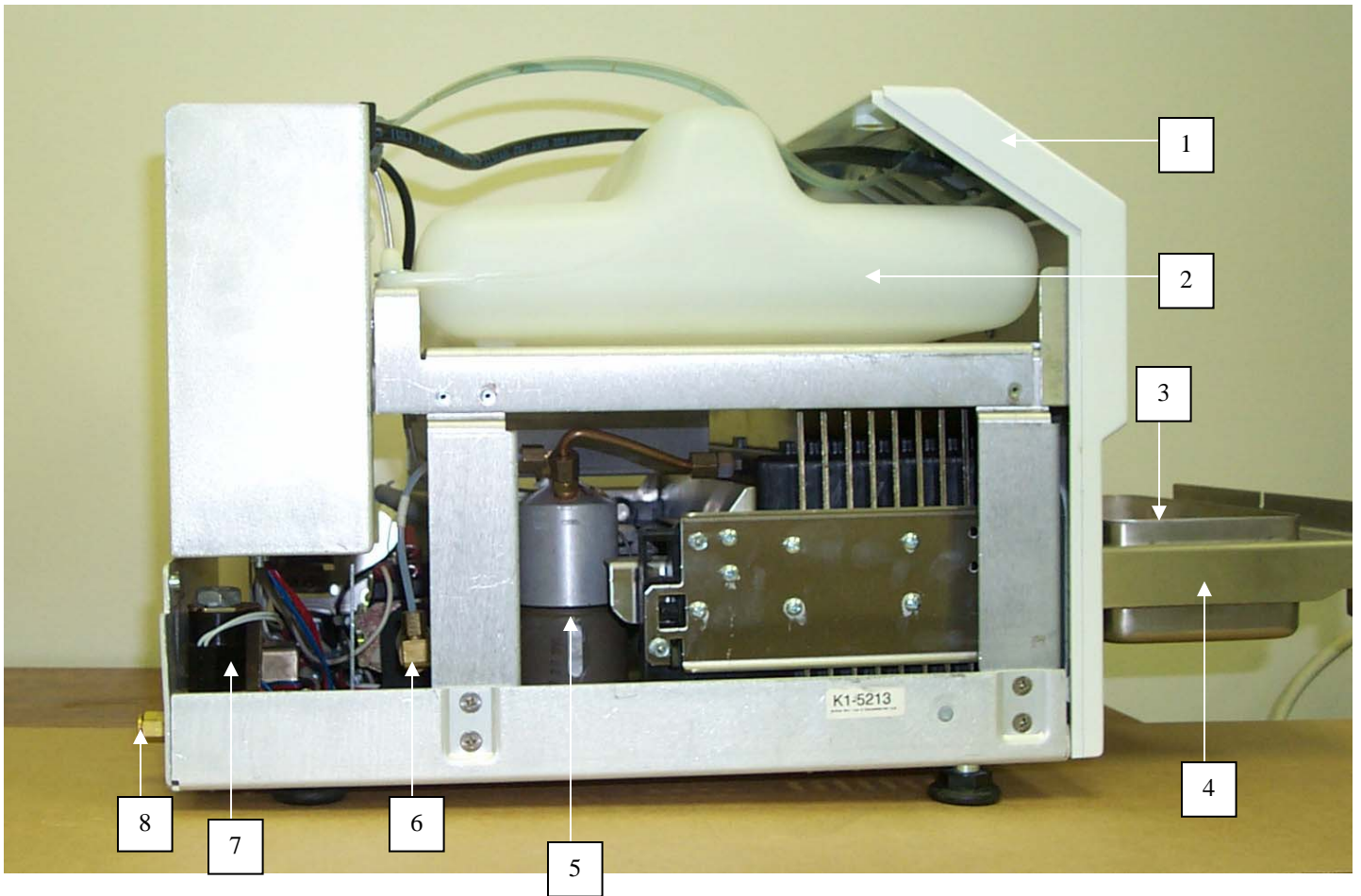

Item #	Part #	Description
1	01-103508S	Facia
2	01-101542S	Reservoir
3	01-103608S	Sterilization Chamber
4	01-101562S	Drawer
5	01-101556S	Boiler
6	01-102038S	Pump
7	01-101550S	Solenoid
8	01-100782S	Push In Fitting

## 900 Parts Right Side View

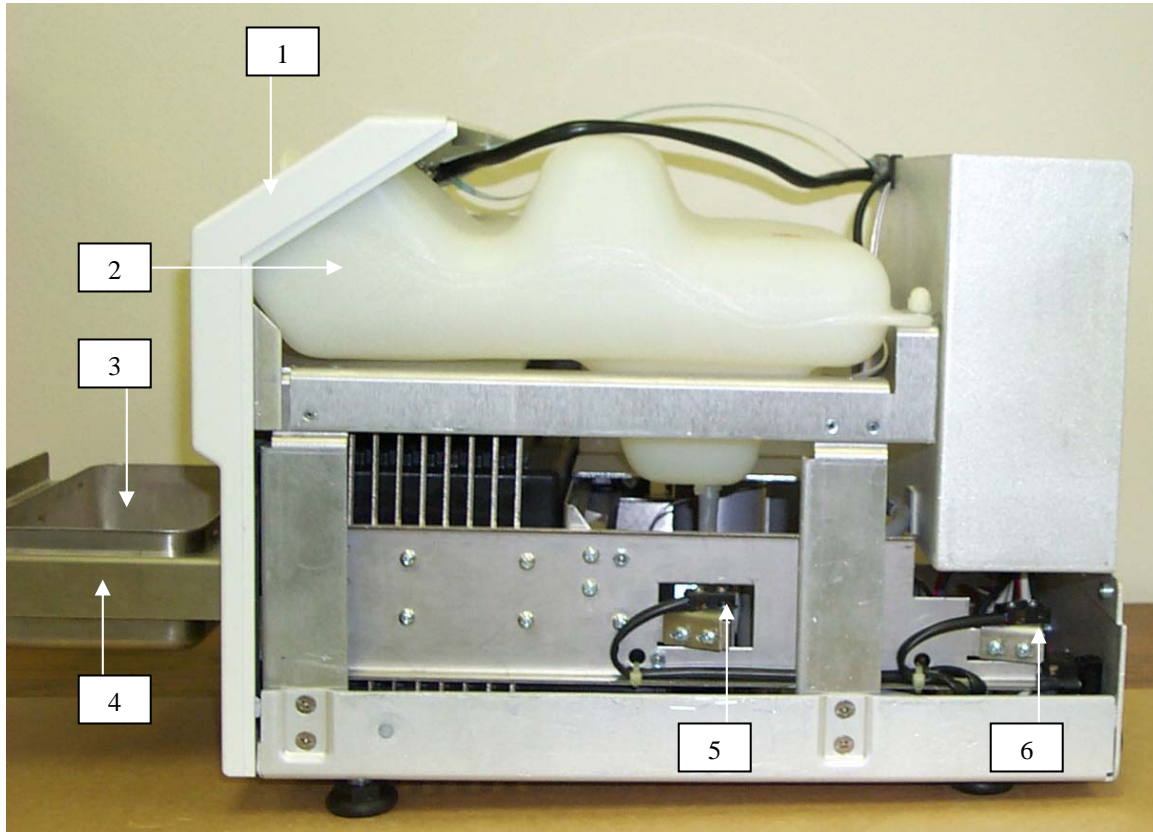

Item #	Part #	Description
1	01-103508S	Facia
2	01-101542S	Reservoir
3	01-103608S	Sterilization Chamber
4	01-101562S	Drawer
5	01-101552S	Microswitch
6	01-101552S	Microswitch



### 900 Parts Top View

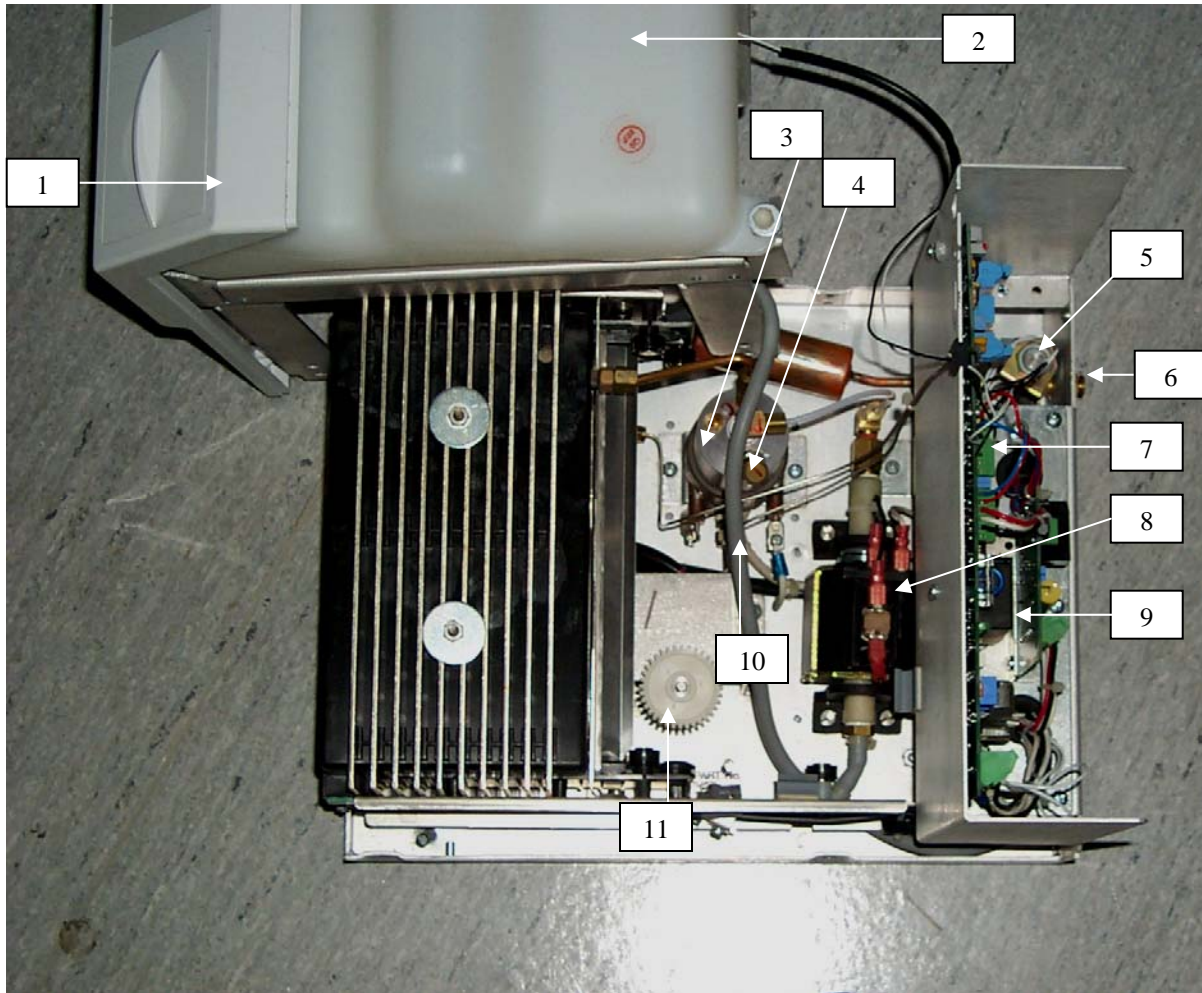

Item #	Part #	Description
1	01-103508S	Facia
2	01-101542S	Reservoir
3	01-101556S	Boiler
4	01-103085S	Pressure Relief Valve
5	01-101550S	Solenoid
6	01-100782S	Push In Fitting
7	01-106055S	PCB (not field replaceable, see note)
8	01-102038S	Pump
9	01-102061S	Motor Control PCB
10	01-104461S	Thermal Fuse (not shown, under boiler)
11	01-101545S	Motor
<b>Note: PCB is not field replaceable requires chamber and boiler calibration</b>		