



REMIO

Communicating interface for the TE range of power units

TPO Version: Time Proportioning Output

Communications protocols

Modbus®

Profibus-DP

DeviceNet™

User Manual

© Copyright Eurotherm Automation 1998

All rights reserved. All reproduction or transmission in any form or using any procedure (electronic or mechanical, including photocopying or recording) without written authorisation from EUROTHERM is strictly prohibited.

Part No. HA 175874 ENG - Issue 2.2 - Printed in France 10/2000

i





CONTENTS

Relevant European Directives

Chapter 1 Identifying The Interface	1-1
Chapter 2 Wiring	2-1
Chapter 3 Digital Communications	3-1
Chapter 4 Configuration	4-1
Chapter 5 Operation	5-1

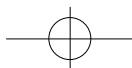
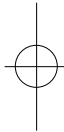
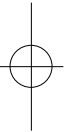



RELEVANT EUROPEAN DIRECTIVES

SAFETY

REMIO products are not affected by the European Low Voltage Directive of 73/23/EEC of 19/2/73 (amended by the Directive 93/68/EEC of 22/7/93).

ELECTROMAGNETIC COMPATIBILITY (EMC)

(For industrial environments only, must not be used in domestic environments)

Eurotherm certifies that **REMIO** products, installed and used in compliance with this User Manual, meet the following EMC test standards and enable the system which incorporates them to comply with the EMC Directive, as far as the **REMIO** products are concerned.

EMC test standards

Immunity	Generic standard:	EN50082-2
	Test standards:	EN 61000-4-2, EN 61000-4-4, EN 61000-4-3, EN 61000-4-6, ENV 50204
Emission	Generic standard:	EN 50081-2
	Radiated:	EN 55011 Class A

EMC Guide

In order to help you reduce the effects of electromagnetic interference depending on the product installation, Eurotherm can supply you with the 'Electromagnetic Compatibility' Installation Guide (part no. HA 025464 ENG).

This guide lists the rules generally applicable for EMC.

VALIDATION BY INDEPENDENT BODY

Eurotherm has validated the compliance of **REMIO** products with EMC test standards through product design and laboratory testing.





Personnel

The installation, configuration, commissioning and maintenance of the REMIO interface must only be carried out by personnel qualified and trained to work with low voltage electrical equipment in an industrial environment.

Independent alarm

Given the safety regulations concerning personnel and property, and the value of the equipment controlled by REMIO and the power units, we recommend the use of independent safety devices (alarms), which should be tested regularly.

Eurotherm can supply various types of alarm device for this purpose.

Further information

For any further information, or if in doubt, please contact Eurotherm Controls where qualified staff are available to advise or assist you with the commissioning of your installation.

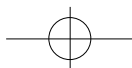
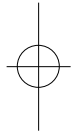
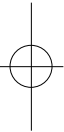



Chapter 1

IDENTIFYING THE REMIO INTERFACE

Contents	Page
General introduction.....	1-2
Front panel of unit.....	1-4
Technical specification.....	1-7
Product code.....	1-9
Example of product code.....	1-10
Identification label.....	1-10

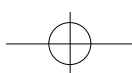
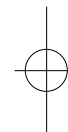
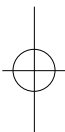



Identifying the unit

Chapter 1 IDENTIFYING THE INTERFACE

GENERAL INTRODUCTION

The **REMIO** communications interface is designed to control **several** power units from the **TE** range via the digital communications bus.

This User Manual describes the use of the **TPO** version of REMIO interfaces, with three communications protocols:

Modbus®, **Profibus-DP**, **DeviceNet™**

The REMIO/TPO interface **receives** setpoints via the communications bus and **transmits** them to the power units which it controls, in the form of a **modulated** logic output signal.

REMIO is a **modular** product, comprising:

- a **Base Module** and
- **two Optional Modules** (Expansion Modules).

The Base Module provides communications bus and power supply connections and the necessary configurations.

In the **TPO** version, each module (the Base Module as well as the Expansion Modules) comprises **16 outputs**, designed to transmit the setpoints received by the communications bus to the power units in the form of a logic output signal with **dual-mode time proportioning (TPO)**.

The maximum **output** count for the **REMIO** is **48**.

REMIO TPO modules allow the use of **two** power unit firing modes, depending on the power supply used:

- **Fast cycling** with a **24Vdc** power supply
- **Advanced Single-cycle** with a **24Vac** supply.

The **LEDs** on the **REMIO** front panel show the state of the communications bus and of the module power supply.

REMIO is mounted on a symmetrical DIN rail.

Detailed operation of the communications bus is described in the following manuals:

- REMIO/Modbus® Communications Manual (part no. HA 175814 ENG)
- REMIO/Profibus-DP Communications Manual (part no. HA 176078 ENG)
- REMIO/DeviceNet™ Communications Manual (part no. HA 176272 ENG)

Operation of the power units controlled is described in the User Manuals:

- TE10S/DC (part no. HA174780 ENG)
- TE10S/PLF (part no. HA174784 ENG)
- TE200S (part no. HA175921 ENG)
- TE300 (part no. HA175437 ENG)



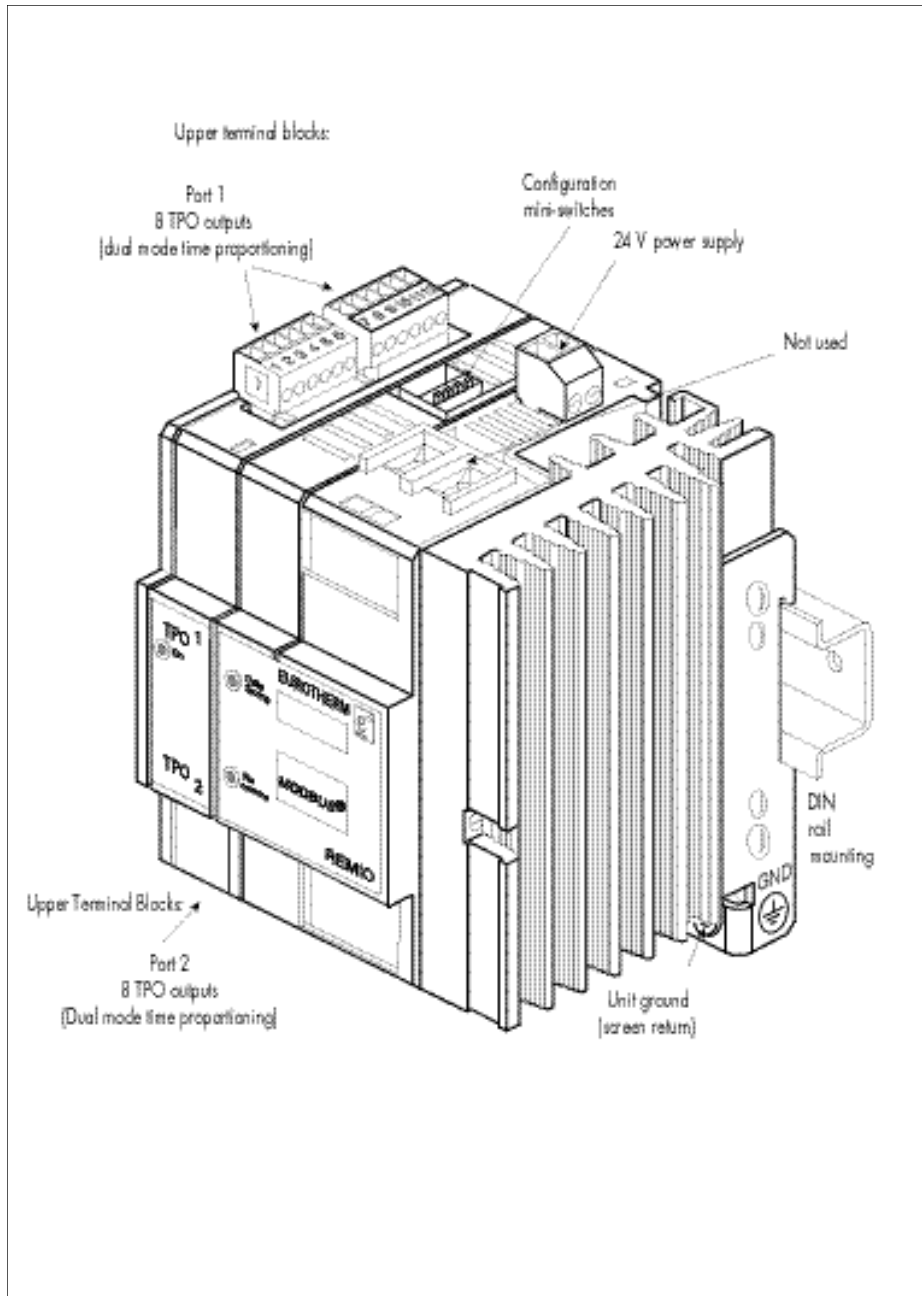

Figure 1-1 Overview of REMIO/TPO Base Module (Modbus® protocol)

Identifying the unit

FRONT PANEL OF UNIT

The following diagrams show:

- the front panels of the REMIO/TPO unit in various physical configurations
 - without optional modules: Base Module version
 - with optional modules (maximum configuration)
- the front panel labels which correspond to each protocol.

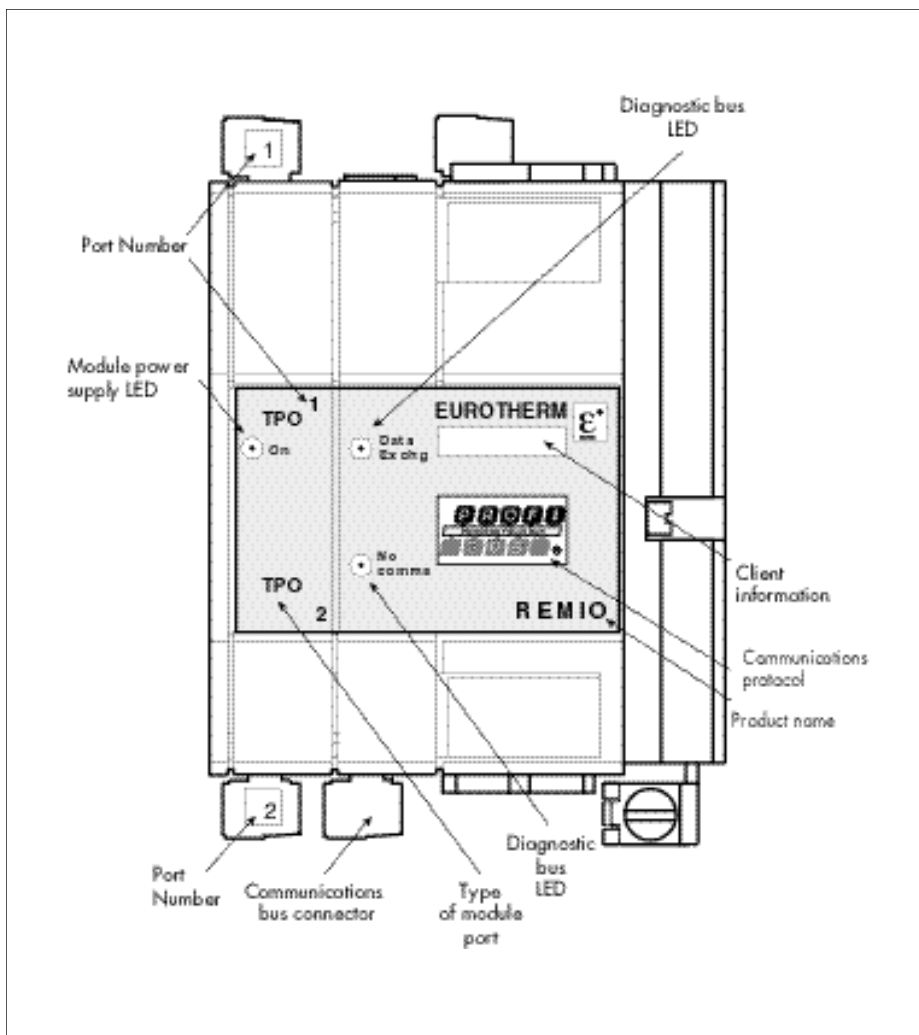

Figure 1-2 Front panel of REMIO/TPO (Profibus-DP protocol) in Base Module version

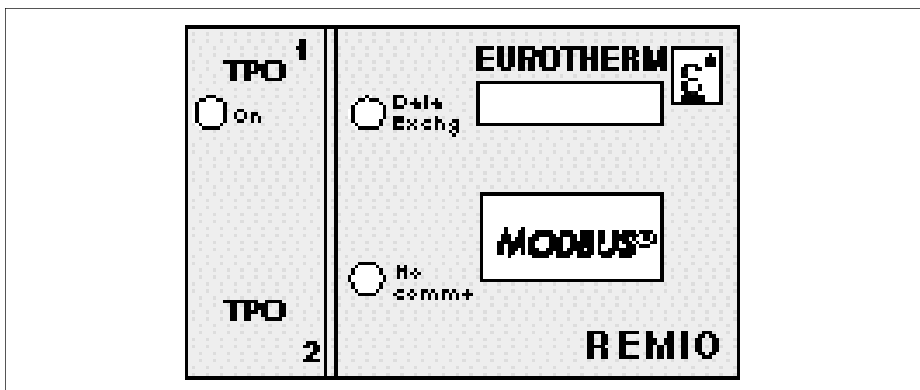

Figure 1-3A REMIO/TPO Base Module label in Modbus® protocol

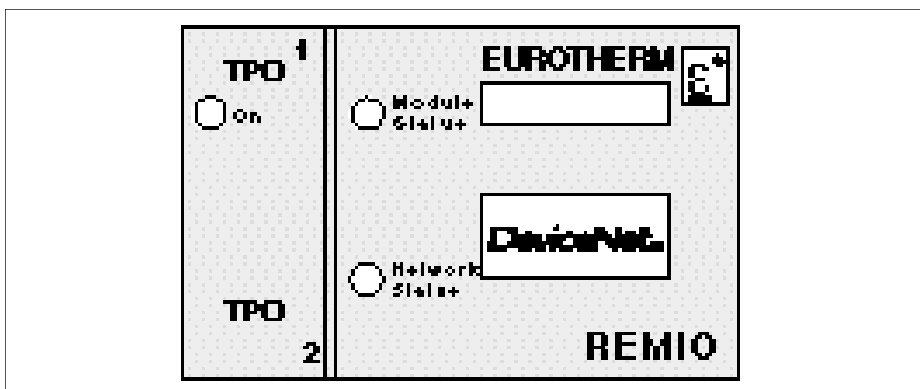

Figure 1-3B REMIO/TPO Base Module label in DeviceNet™ protocol

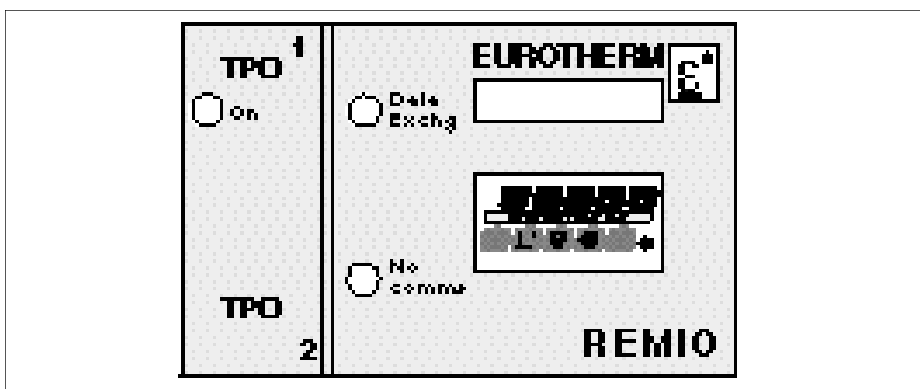
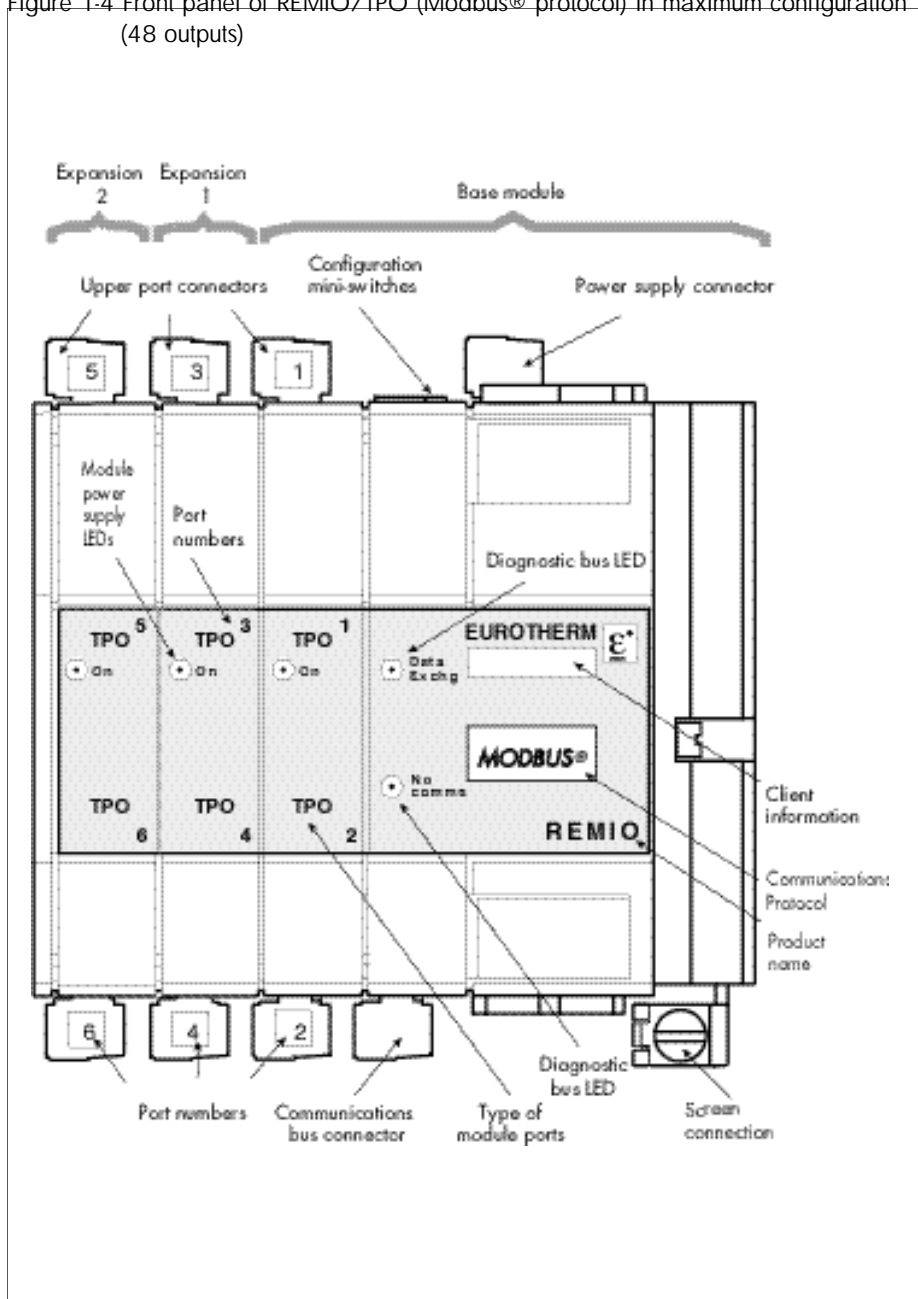

Figure 1-3C REMIO/TPO Base Module label in Profibus-DP protocol

Identifying the unit

Figure 1-4 Front panel of REMIO/TPO (Modbus® protocol) in maximum configuration (48 outputs)





TECHNICAL SPECIFICATION

The REMIO communications interface is designed to drive various thyristor power units controlling resistive industrial loads and short-wave infrared elements.

Hardware configuration

Base Module	2 ports each with 8 outputs providing dual-mode time proportioning logic output signals (TPO). - Configuration mini-switches - Power supply connector - Communications bus connector
Expansions 1 or 2	2 ports each with 8 outputs providing dual-mode time proportioning logic output signals (TPO).

Port specification

TPO outputs	Voltage 20V, modulated Time proportioning from 0 to 100% Maximum current limited to 6.5mA Possible to connect two solid state relay (SSR) inputs from the TE range in series on each TPO output
Common excitation potential	For all TPO outputs a common +20Vdc supply is available on each port.
Resolution	8 bits (0.4%)
Connectors	Plug-in, M3 screws

Communications

Communications protocol	Modbus or Profibus-DP or DeviceNet™ (specify when ordering)
Bus	2-wire Standard RS485 (Modbus® or Profibus-DP) or CAN Bus (DeviceNet™)
Transmission baud rate	Modbus: 9.6k or 19.2kbaud (configurable) Profibus-DP: auto Baud rate detection up to 1.5Mbaud DeviceNet™: 125k, 250k or 500kbaud (configurable)

Diagnostics

Communications	State of communications bus
LED indication	State of REMIO and of TPO outputs Bus state, REMIO state (DeviceNet) Module power supply

Power supply

Voltage	24Vdc non-polarised (-15%, +25%) or 24Vac (-15%, +10%), 47 - 63 Hz
Consumption	Depends on number of outputs used (20VA max)

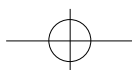



Identifying the unit

Thyristor firing

General	All base module and optional module outputs are modulated in the same way: Burst-firing or Intelligent Single-cycle
Selection	By type of supply voltage
Firing modes	DC supply voltage (24Vdc): Burst-firing Number of firing or non-firing cycles at 50% setpoint: 8 cycles AC supply voltage (24Vac): Intelligent Single-cycle Firing or non-firing by a complete number of half-cycles DC component absent
Switching	Firing starts and ends at zero voltage

Environment

Operating temperature	0°C to +45°C at 2000m max. altitude
Storage temperature	-10°C to +70°C
Power supply circuit protection	External 2A fuse
External wiring	To be carried out in accordance with Standard IEC 364
Operating atmosphere	Non-explosive, non-corrosive & non-conductive
Humidity	RH: 5% to 95%, non-condensing and non-streaming
Pollution	Pollution degree 2 permissible, defined by IEC 664

Physical dimensions

Dimensions (mm)	Height: 115 (122: including connectors) Depth: 92.5 Width: Base module = 87.5 One Optional Module = 17.5 Maximum configuration = 122.5
Mass (kg)	0.9 (maximum configuration)



Warning!

EUROTHERM has made every effort to ensure that the specification given in this manual is as accurate and up to the minute as possible. However, in order to maintain our 'leading edge', it may be necessary to make certain changes or omissions to our specification.

We cannot be held responsible for any damage to persons or property or for any financial loss or costs arising from this.

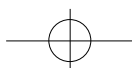

PRODUCT CODE

REMIO / Base Module / Exp.1 / Exp.2 / Protocol / Transmission rate / Manual // 00

Base Module	Code
16 dual-mode* time-proportioned outputs	TP

Expansion Module 1	Code
Expansion 1 provides (16 dual-mode* time-proportioned outputs) Without Expansion 1	TP -

Expansion Module 2	Code
Expansion 2 provides (16 dual-mode* time-proportioned outputs) Without Expansion 1 or 2	TP -

Communications protocol	Code
Modbus® Profibus-DP DeviceNet™	MOP PFP DNP

Transmission rate	Code
Modbus® : 9.6kbaud	96
19.2kbaud	192
Profibus-DP : (auto Baud rate detection)	AUTO
DeviceNet™ : 125kbaud	125
250kbaud	250
500kbaud	500

Manual language	Code
French	FRA
English	ENG

*) The firing mode of TPO module outputs is determined by the power supply type:
24Vac = Advanced Single-cycle; 24Vdc = Fast Cycling



Identifying the unit

EXAMPLE OF PRODUCT CODE

Example 1

Number of TE10S solid state relays (SSRs) controlled by REMIO : 15
(15 < 16 = without Expansion Modules)

Communications used: Modbus® at 9.6kbaud
Firing mode: Advanced Single-cycle
User Manual: English

Code: REMIO / TP / - / - / MOP / 96 / ENG // 00
Power supply : 24Vac

Example 2

Number of TE10S solid state relays controlled by REMIO : 40
(2 x 16 = 32 < 40 < 3 x 16 = 48 fi 2 Expansion Modules)

Communications used: Profibus-DP
Firing mode: Fast Cycling
User Manual: French

Code: REMIO / TP / TP / TP / PFP / AUTO / FRA // 00
Power supply : 24Vdc

IDENTIFICATION LABEL

An identification label gives all the necessary information on REMIO characteristics, as shipped from the factory. The identification label is located on the left side of the unit.

Figure 1-5 Example of REMIO identification label (corresponds to coding example No. 1)



Warning!

Following any re-configuration on the part of the user, there is no guarantee that the unit will correspond to the label information.

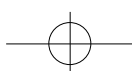



Chapter 2

WIRING

Contents	Page
Installation - safety	2-2
Wiring – safety	2-2
Terminal block labelling	2-3
Control	2-3
Power supply	2-9
Communications bus	2-10
Screening example	2-12
Wiring example of REMIO/ TE assembly	2-13

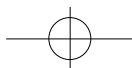
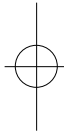
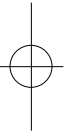



Wiring

Chapter 2 WIRING

INSTALLATION - SAFETY

**Danger!**

REMIO units must be installed by qualified personnel trained to work with low voltage electrical equipment in an industrial environment.

Units must be installed in fan-cooled electrical cabinets, to ensure that condensation and pollution are excluded.

The cabinet must be closed and bonded to the protective earth in accordance with Standards NFC 15-100, IEC 364 or current national Standards.

It is recommended that a fan-failure detection device or a thermal safety cut-out should be fitted in the cabinet.

**Warning!**

REMIO units are designed to be DIN-rail mounted, with the heatsink positioned vertically, with no obstructions above or below which could inhibit or impede airflow.

Leave a minimum gap of 2cm between two units placed side by side.

The temperature of the heatsink may reach 85°C. Avoid all contact, even occasional, with the heatsink when the unit is operational.

The heatsink remains hot for around 15 minutes after the unit has been switched off.

WIRING - SAFETY

**Danger!**

REMIO wiring must be carried out by trained personnel who are qualified to work in a low voltage industrial environment.

It is the user's responsibility to wire and protect the installation in accordance with current professional Standards.

Before any connection or disconnection, ensure that the power supply cables are isolated from voltage sources.

**Warning!**

The REMIO earthing screw, labelled:



must be connected to the reference ground plane of the electrical cabinet.

To ensure correct grounding of the REMIO unit, in accordance with the European Directive 'Electromagnetic Compatibility' make sure that the ground link of the unit is properly bonded to the reference ground plane (panel or bulkhead).

Failing this, it is necessary to add a ground connection at most 10cms long between the earth connection and the reference ground plane.

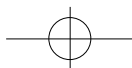

TERMINAL BLOCK LABELLING

The REMIO communications interface comprises the following terminal blocks:

- control terminal blocks (2 terminal blocks of 6 terminals for each port)
- power supply terminal block
- communications bus terminal block.

The connectors are **plug-in**.

The terminals on the control and communications bus terminal blocks accept conductors up to a maximum of **1.5mm²**.

The terminals on the power supply terminal block accept conductors up to a maximum of **2.5mm²**.

Control

Control terminal block

Each control port consists of **two** terminal blocks (two plug-in connectors).

Each 6-terminal control terminal block (see Figures 2-1 to 2-4) comprises **4** TPO outputs and **2** 'common +20Vdc' terminals (terminal numbers **1, 6** or **7, 12**).

Module type	Port numbers	Terminal numbers	TPO output numbers
Base module	1	2 to 5	1 to 4
	1	8 to 11	5 to 8
	2	2 to 5	9 to 12
	2	8 to 11	13 to 16
1st Optional module	3	2 to 5	17 to 20
	3	8 to 11	21 to 24
	4	2 to 5	25 to 28
	4	8 to 11	29 to 32
2nd Optional module	5	2 to 5	33 to 36
	5	8 to 11	37 to 40
	6	2 to 5	41 to 44
	6	8 to 11	45 to 48
All types	1 to 6	1, 6, 7 & 12	User voltage +20Vdc

Table 2-1 Terminal function of control terminal blocks

Reminder : the maximum current of a TPO output is **6.5mA**

Wiring

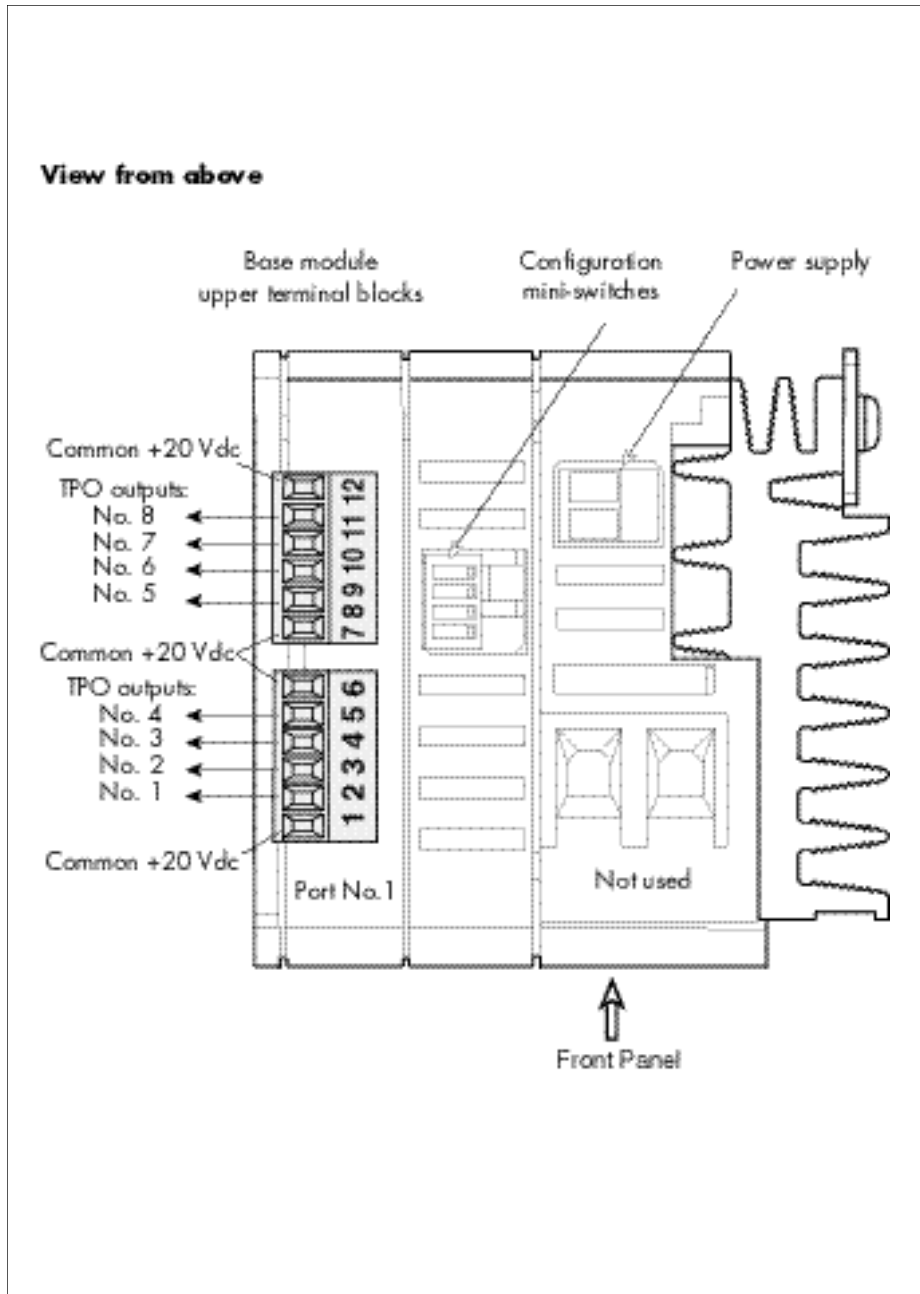

Figure 2-1 Labelling on Base Module control terminals (upper terminal blocks)

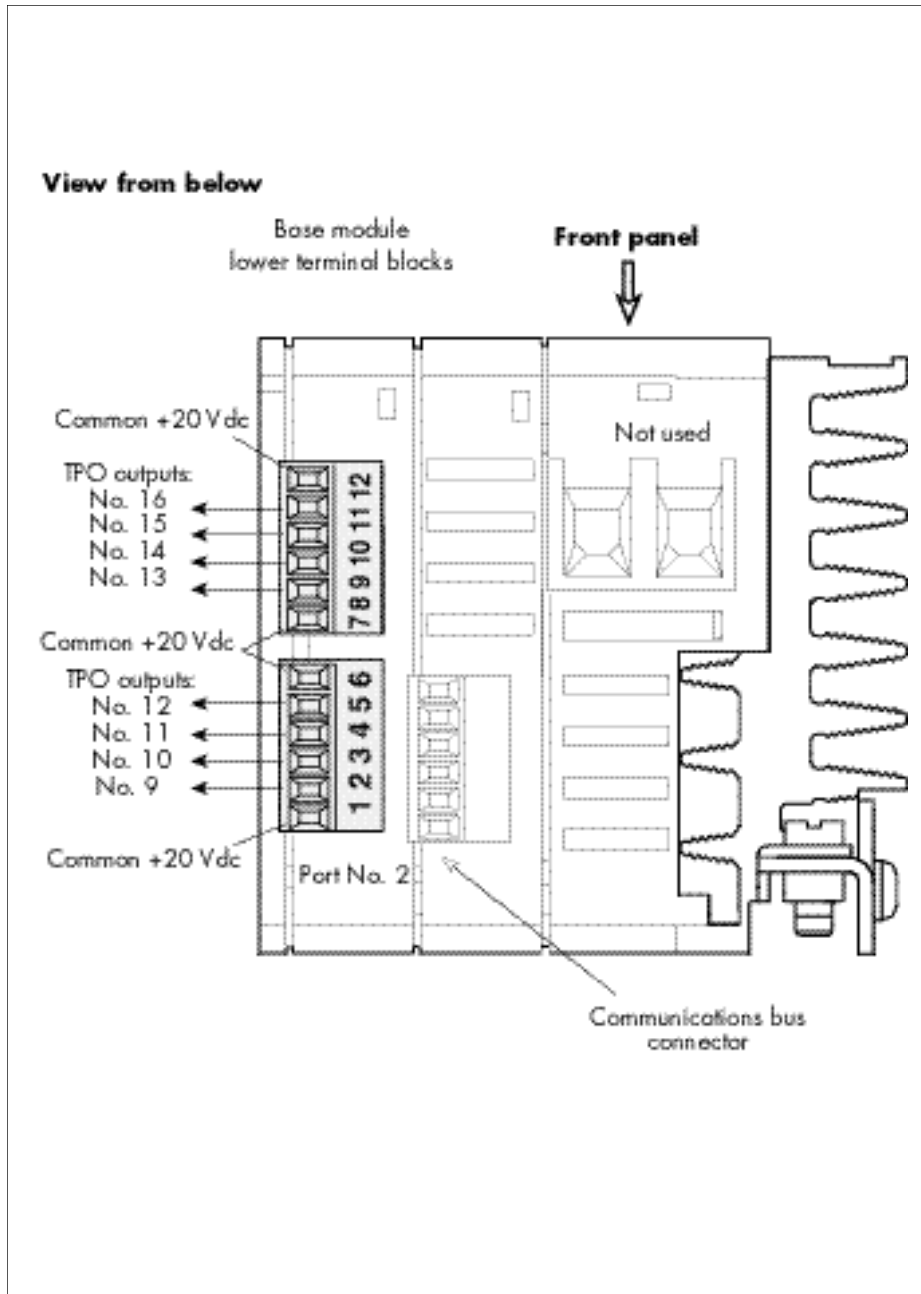

Figure 2-2 Labelling on Base Module control terminals (lower terminal blocks)

Wiring

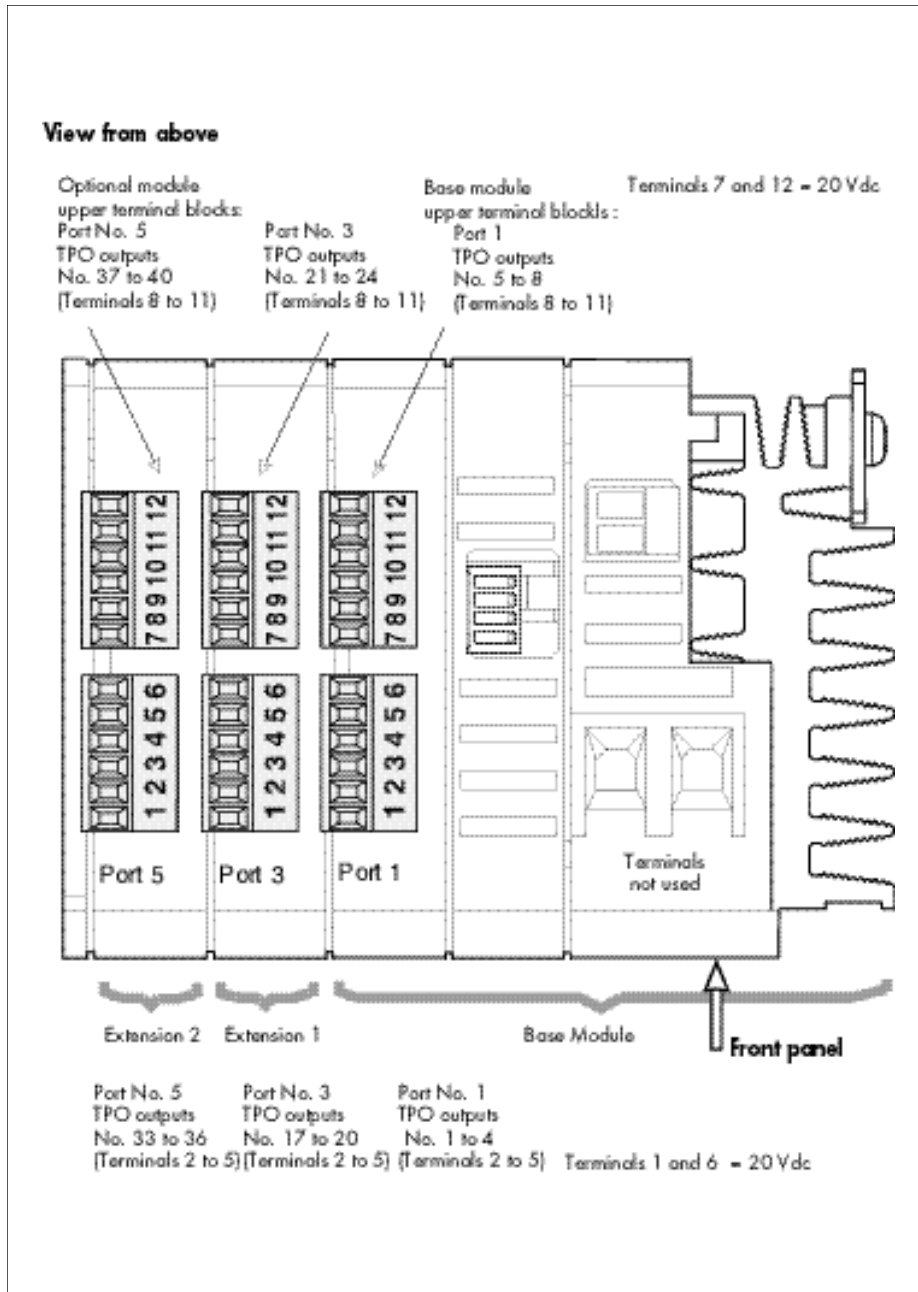

Figure 2-3 Labelling on control terminals (2 Expansion Modules, upper terminal blocks)

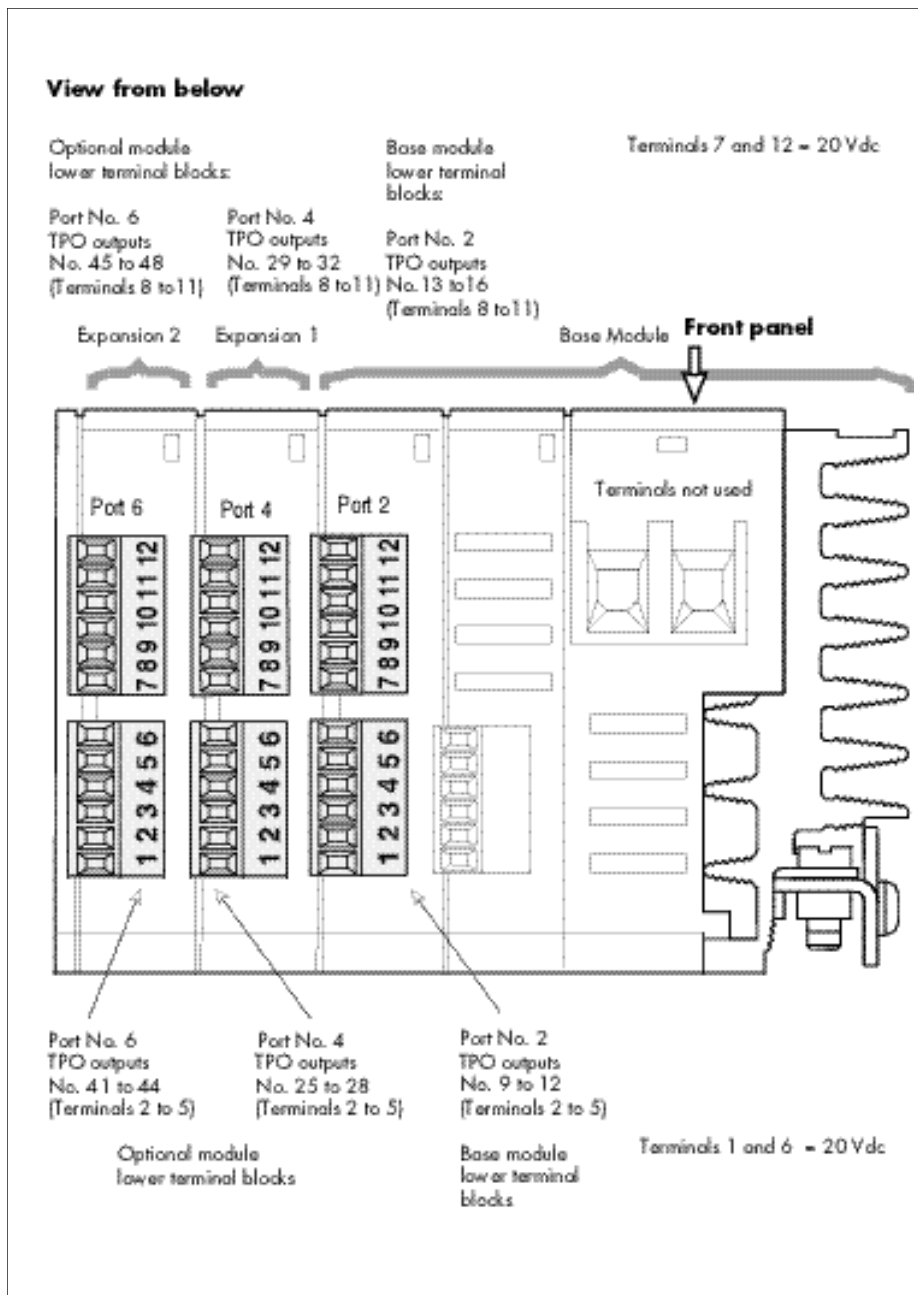

Figure 2-4 Labelling on control terminals (2 Expansion Modules, lower terminal blocks)

Wiring

Control wiring

REMIO TPO outputs must be connected to DC inputs (DC current) on thyristor power units.

The following diagram shows an example of control wiring for two power units: two Eurotherm TE10S solid state relays (SSRs).

Power cabling is not shown in this diagram (for wiring of power unit supply and load cables, see the appropriate User Manuals).

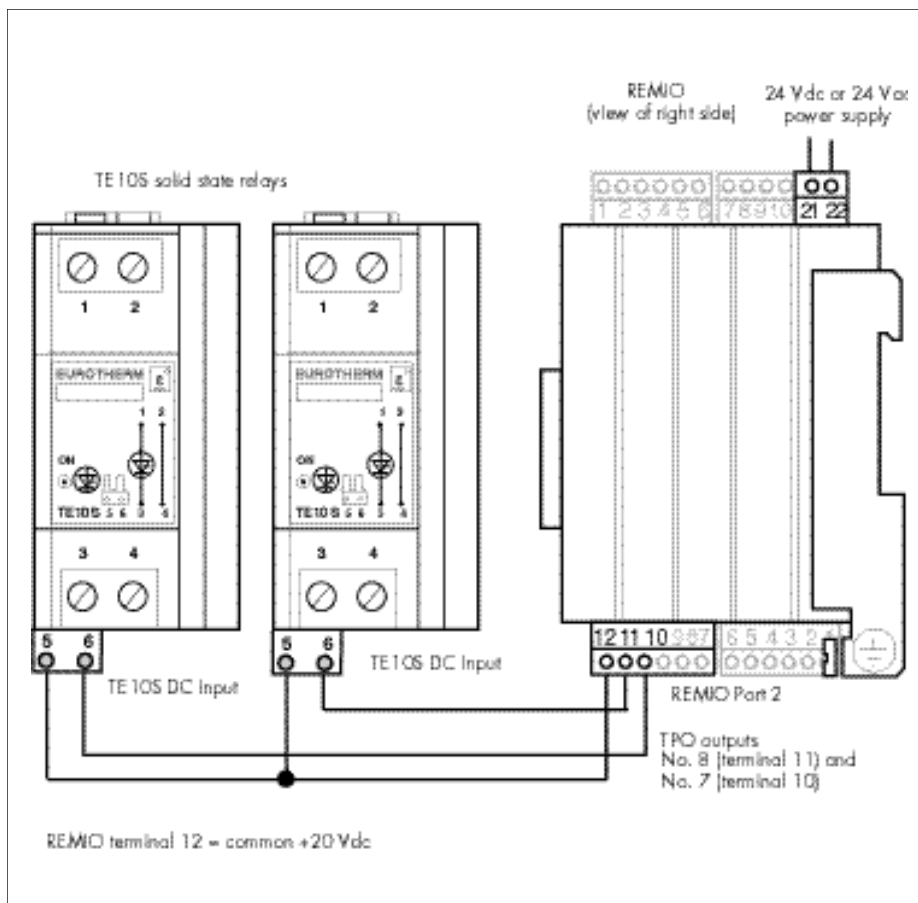

Figure 2-5 Example of control wiring for TE10S power units (REMIO port 2 outputs 7 & 8)

Power supply

The power supply terminal block (terminals **21** & **22**) is located on top of the unit. The connector is of the plug-in type.

The voltage is: **24Vdc non-polarised** (-15%, +25%) or **24Vac** (-15%, +10%).

Reminder: The type of power supply defines operation in Fast cycling (24Vdc) or in Advanced Single-cycle (24Vac).

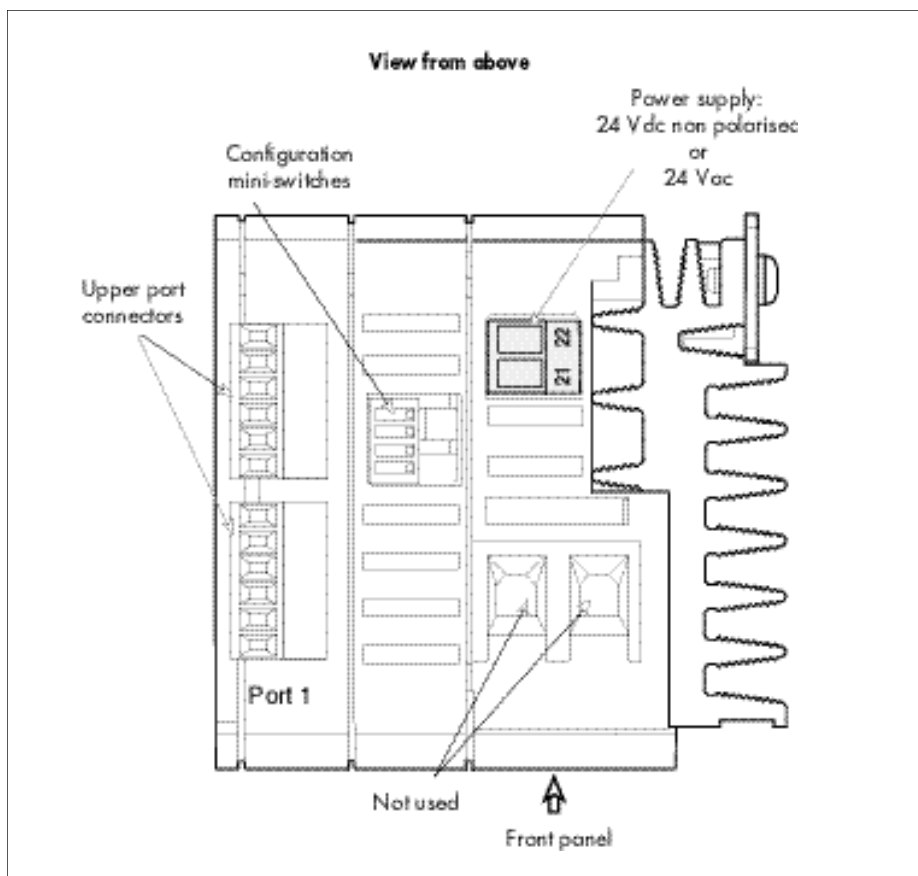

Figure 2-6 REMIO power supply terminal block (view from above)



Warning!

A **2Amp** fuse must be provided for power supply protection



Wiring

Communications bus

Communications bus terminal block

The communications bus terminal block is located underneath the unit.

- This terminal block has:
- 6 terminals, numbered 61 to 66 for Modbus® and Profibus-DP protocols
 - 5 terminals, numbered 1 to 5 for DeviceNet™ protocol

Terminal Number	Terminal labelling, depending on protocol		
	Modbus®		Profibus-DP
61	Rx-/Tx-	(B)	B
62	Rx+/Tx+	(A)	A
63	Not used	(0V)	0V
64	Rx+/Tx+	(A)	A
65	Rx-/Tx-	(B)	B
66	Not used	Not connected	+5V

Table 2-2 Labelling on communications bus terminals in Modbus® and Profibus-DP protocols



Important!

- In **Profibus-DP** protocol, by convention the potential of the **A** terminals is **greater** than that of the **B** terminals when the RS485 line is in an **active** state
- In **Modbus® and Profibus-DP** protocols:
 - terminals **61 & 65** are **internally interconnected**;
 - terminals **62 & 64** are **internally interconnected**

Terminal Number	Terminal labelling, depending on DeviceNet™ protocol	
1	V-	(B)
2	CAN_L	(A)
3	Drain (not connected)	(0V)
4	CAN_H	(A)
5	V+	(B)

Table 2-3 Labelling on communications bus terminals in DeviceNet™ protocol

Communications bus wiring

In order to guarantee **operational reliability** of the digital communications link (without data corruption due to noise or line reflection) connections should be made using **screened, twisted pairs**.

The screen should be **connected to the ground** at both ends in accordance with the wiring diagrams (see Figures 2-8 & 2-9).

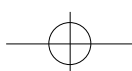

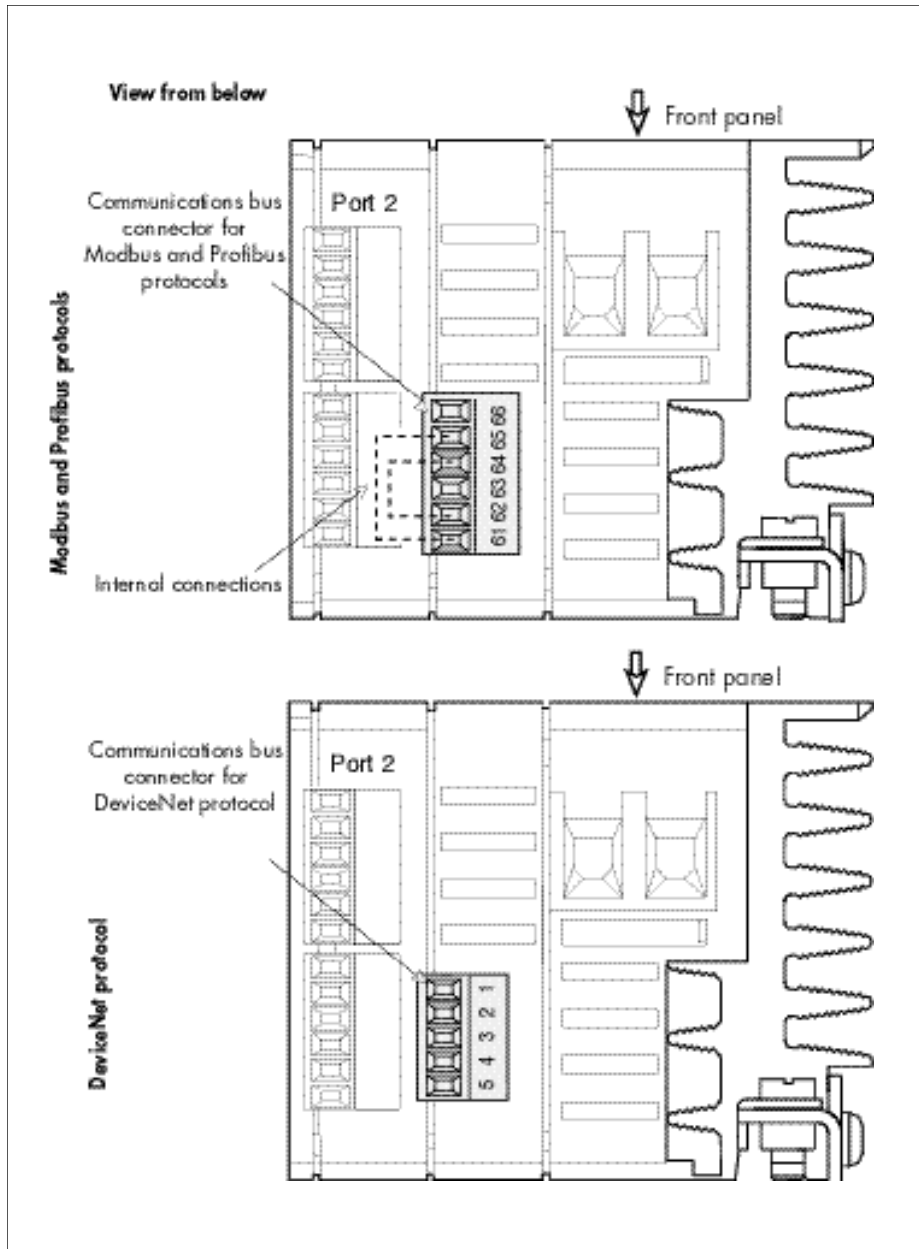

Figure 2-7 Communications bus terminal block for various protocols

Wiring

SCREENING EXAMPLE

Control and communications bus cable screens should be connected to ground at both ends, in the shortest possible way.

A screen grounding screw is provided for this purpose on the REMIO.

Important!

The ground return screw of the unit should be connected to the ground plane via the shortest possible link.

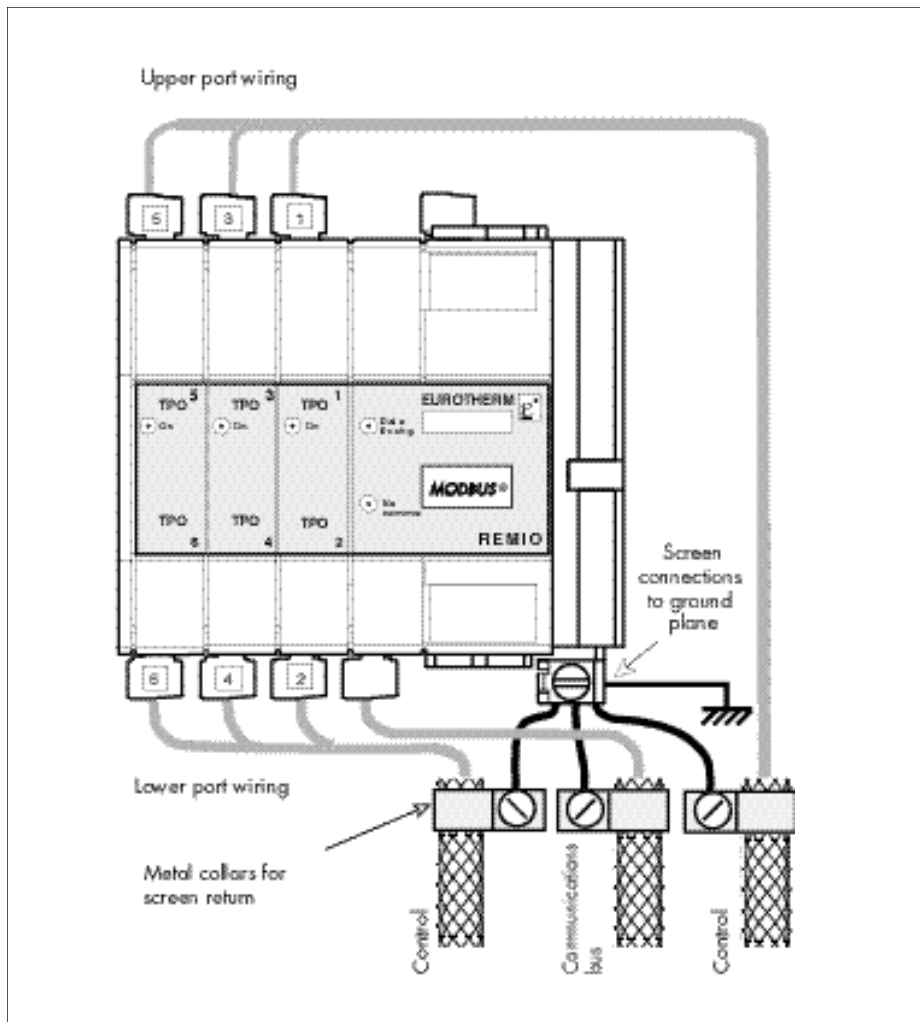



Figure 2-8 Screen grounding example for control and communications conductors



WIRING EXAMPLE OF REMIO/TE ASSEMBLY

Wiring of the REMIO interface and power unit assembly comprises:

- REMIO ground wiring, labelled with the symbol 
- power supply wiring
- communications bus connection
- power unit control wiring.

In order to guarantee correct EMC **performance** of the power units controlled by the REMIO, REMIO outputs and the power unit inputs should be wired using **screened cables**.

Control and communications bus cable screens must be connected to the REMIO ground as shown in Figure 2-8.

Figure 2-9 gives a wiring example for an assembly of REMIO and TE range power units.

TE unit power wiring is not shown in Figure 2-9.
For power wiring, see the User Manuals for the TE range.

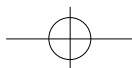
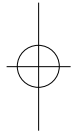
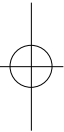

Wiring

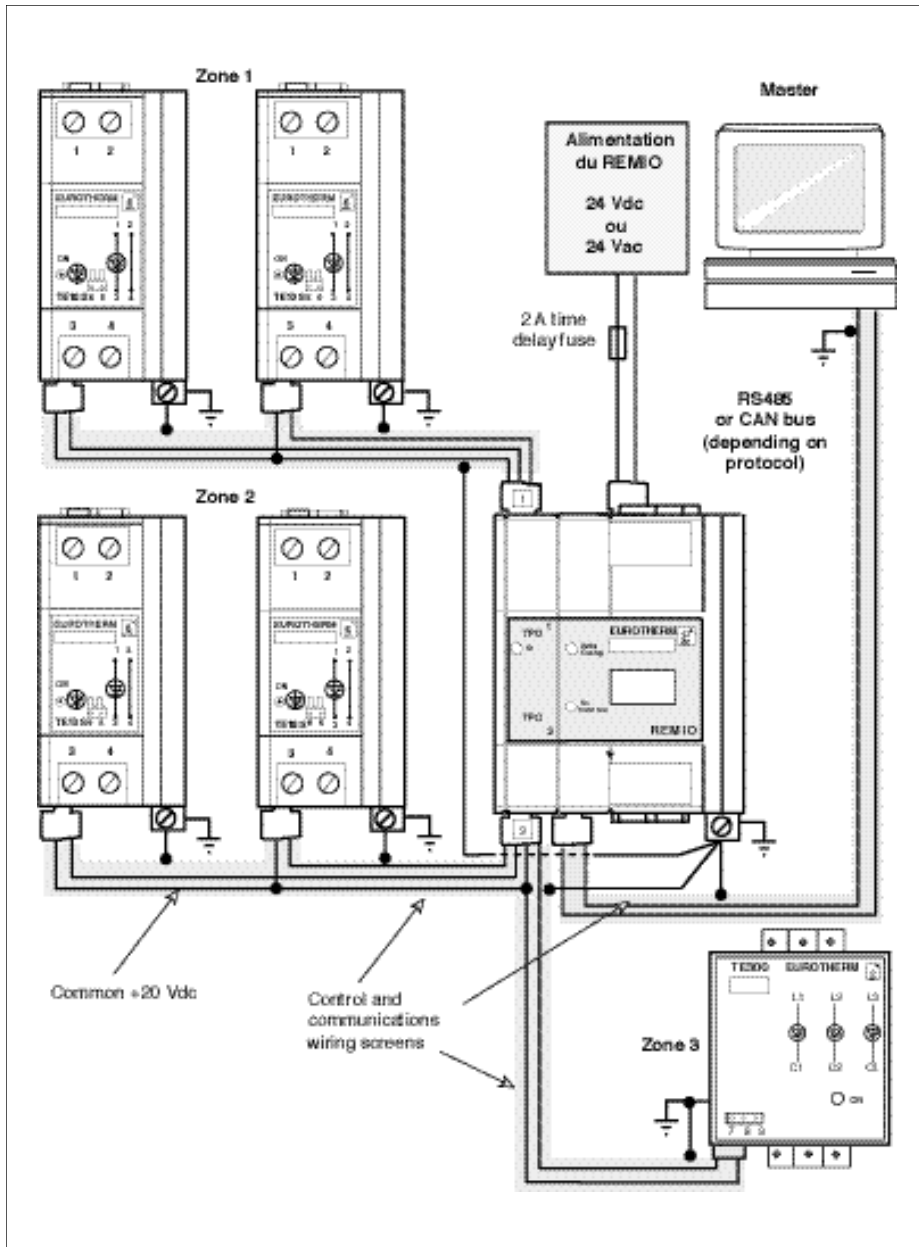

Figure 2-9 Wiring example of power unit assembly from the TE range (divided into three zones), controlled by the REMIO / TPO Base Module.
 Note : TE300 operation is in Logic Mode only



Chapter 3

DIGITAL COMMUNICATIONS

Contents	Page
General introduction.....	3-2
Modbus® protocol.....	3-3
Addressing.....	3-4
Profibus-DP protocol.....	3-5
State Diagram.....	3-7
Devicenet™ protocol.....	3-10
Addressing.....	3-12
State diagram for operation.....	3-13

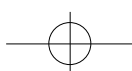
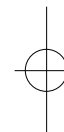
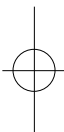

Chapter 3 DIGITAL COMMUNICATIONS

GENERAL INTRODUCTION

REMIO interfaces are fitted with digital communications as standard.

This performs four main functions:

- configuring the communications protocol parameters
- configuring the REMIO interface address on the bus
- controlling the state of the REMIO interface
- monitoring all the operating parameters.

This digital link is available for the following data transfer physical layer standards:

- **RS485** for **Profibus-DP** or **Modbus®** communications protocols
- **CAN** for **DeviceNet™** protocol.

The communications bus is **electrically isolated** from any other inputs or outputs.

The choice of protocol is made **when ordering** the unit and cannot be **re-configured** by the user.

Message transfer is of the 'Master/Slave' type.

The REMIO interface always operates in '**Slave**' mode, with the monitoring system or supervisor as 'Master'.

Any exchange includes a request from the 'Master' and a response from the 'Slave'.

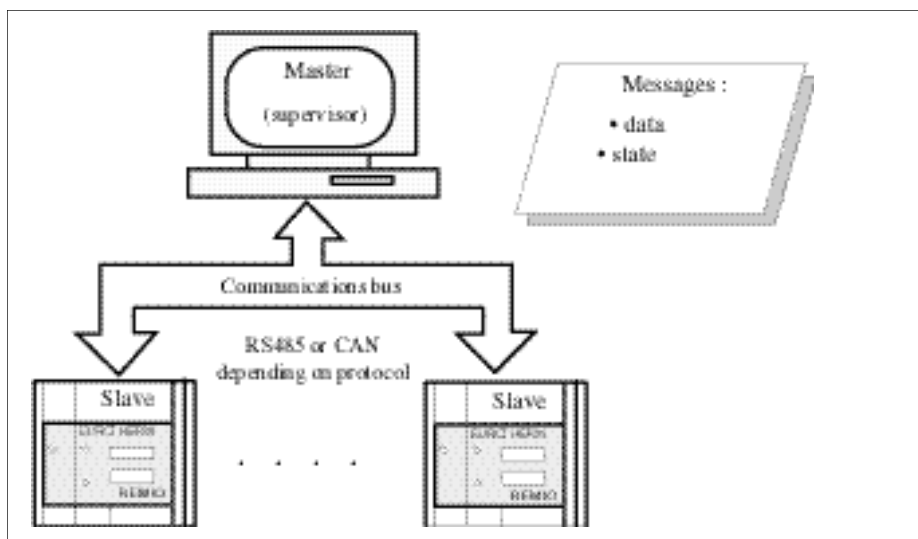

Figure 3-1 Data transfer organisation

THE MODBUS® PROTOCOL

The **Modbus®** protocol is a binary type serial communications protocol (or RTU).

Important : A detailed description of how Modbus® protocol operates is given in the manual 'REMIO: Modbus® Communications Manual', part no. HA 175814 ENG

The transmission frame is in binary characters.
Character format: 1 start-bit – 8 data bits – 1 stop bit
There is no parity bit

Transmission rates:

9.6 or 19.2 kbaud,
depending on the mini-switch configuration provided

Modbus® protocol controls the request and response cycle between the Master and the Slaves. Each exchange comprises two messages, except in broadcast mode when the response is not transmitted.

The frame structure is identical for the request and the response:

- Slave address (1 byte) : specifies the Slave concerned on the communications bus
- function code (1 byte) : indicates the operation to be carried out
- data (n bytes) : group of parameters necessary for the function
- CRC -16 error check (2 bytes) : cyclic redundancy check

The error response frame structure comprises:

- Slave address (1 byte)
- function code +128 (1byte)
- error code (1 byte)
- CRC – 16 error check (2 bytes) : cyclic redundancy check.

Error codes

Error code (in decimal)	Error type
1	Function forbidden
2	Data address prohibited
3	Data value outside limits
4	Peripheral failure
5	ACK (positive acknowledging signal)
6	Not used (reserved)
7	NACK (negative acknowledging signal)
8	Write operation not possible
9	No data request
10	Too many data requests

Table 3-1 Meaning of Modbus® error codes

Communication

Addressing

To communicate with REMIO, Modbus® protocol uses:

- the REMIO interface **device address** (address **on the bus** used)
- the **TPO output addresses** of each port.

Important!

As **shipped from the factory**, the REMIO **default** device address is configured to **32** (decimal).



This address may be **re-configured** by the user via the **digital link**.

In normal operation, addresses **1** to **247** may be used for the **device address**.



Important!

Make sure that there is **only one unit** at each device address.

The REMIO address is located at internal address **100**, in the internal parameter list. The values of the TPO output parameters are from **0** to **255** (**00_{HEX}** to **FF_{HEX}**), which constrains the data value at each of these addresses to one byte (**8 bits**).

The addresses are accessible in read and write. The contents of all TPO output addresses **can be modified** by broadcast, **except the REMIO device address**.

The '**TPO output**' parameters are located from address **11** to **58** in the parameter list.

Module	Parameter TPO outputs			Internal address (decimal)
	Port	Output No.	Terminal No.	
Base Module	Port 1	1 to 4 5 to 8	2 to 5 8 to 11	from 11 to 14 from 15 to 18
	Port 2	9 to 12 13 to 16	2 to 5 8 to 11	from 19 to 22 from 23 to 26
1st Optional Module	Port 3	17 to 20 21 to 24	2 to 5 8 to 11	from 27 to 30 from 31 to 34
	Port 4	25 to 28 29 to 32	2 to 5 8 to 11	from 35 to 38 from 39 to 42
2nd Optional Module	Port 5	33 to 36 37 to 40	2 to 5 8 to 11	from 43 to 46 from 47 to 50
	Port 6	41 to 44 45 to 48	2 to 5 8 to 11	from 51 to 54 from 55 to 58

Table 3-2 'TPO output' parameter addresses in Modbus® protocol



PROFIBUS-DP PROTOCOL

Specifications for **Profibus-DP**

Process Field Bus Decentralised Periphery

communications protocol are defined in Standards:

EN 50170 / DIN 19245 / Part 3.

Important!

A detailed description of Profibus-DP operation is given in the manual 'REMIO: Profibus-DP Communications Manual, part no. HA 176078 ENG

The transmission frame is in binary characters, with even parity.
Character format : 1 start-bit – 8 data bits – 1 parity bit – 1 stop bit

Transmission rate

The following transmission rates are available:

9.6 kbaud
19.2 kbaud
93.75 kbaud
187.5 kbaud
500 kbaud
1500 kbaud

with **auto Baud rate detection**.



Communication

Addressing

The **device address** (address of the **REMIO** on the bus used) is set by configuration using the Profibus-DP function **Set_Slave_Address** via the link Master, provided that the REMIO is in the parameterisation wait phase (**WPRM**).

Important!



As **shipped from the factory**, the REMIO default **device address** is configured as **32** (decimal).

This address may be **reconfigured** by the user **via the digital link**.

In normal operation, the following addresses can be used: from **4** to **125**

Important!



Make sure that there is **only one unit** assigned to each device address.

Addresses **0** to **3** are generally reserved for the Master.

Address **126** is not accepted by REMIO.

Address **127** is reserved for broadcast to comply with the Profibus Standard.

The TPO output parameter values are from **0** to **255** (**00_{HEX}** to **FF_{HEX}**) which constrains the data value at each of these addresses to one byte (**8 bits**), with a **0.4%** resolution.

The **TPO output parameters** are accessible at the following addresses:

Module	Parameter TPO outputs			Internal address (decimal)
	Port	Output No.	Terminal No.	
Base Module	Port 1	1 to 4	2 to 5	from 6 to 9 from 10 to 13
		5 to 8	8 to 11	
1st Optional Module	Port 2	9 to 12	2 to 5	from 14 to 17 from 18 to 21
		13 to 16	8 to 11	
1st Optional Module	Port 3	17 to 20	2 to 5	from 22 to 25 from 26 to 29
		21 to 24	8 to 11	
1st Optional Module	Port 4	25 to 28	2 to 5	from 30 to 33 from 34 to 37
		29 to 32	8 to 11	
2nd Optional Module	Port 5	33 to 36	2 to 5	from 38 to 41 from 42 to 45
		37 to 40	8 to 11	
2nd Optional Module	Port 6	41 to 44	2 to 5	from 46 to 49 from 50 to 53
		45 to 48	8 to 11	

Table 3-3 'TPO output' parameter decimal addresses in Profibus-DP protocol



State diagram

The state diagram illustrating data transfer via the Read/Write process comprises **four states** (see Figure 3-2):

- powering up
- waiting for parameterisation
- waiting for configuration
- transfer of parameter data.

Powering up

After each power-up, the unit enters a two sequence **wait phase**:

- Parameterisation then
- Configuration.

Parameterisation

This is the **wait phase for the parameterisation message (WPRM)**.

In this phase, reading the configuration (**Get_Cfg**) is allowed.

A diagnostic request (**Slave_Diag**) is permitted.

The Parameterisation frame (**Set_Prm**) contains the following data:

- Parameterisation of the system (**PNO** identification, acceptance of synchronisation modes, 'Watchdog' time...)
- Parameterisation of the data (the parameters designated by the Master to be accessible in cyclic read).

In addition, as described in the paragraph 'Addressing', in the **WPRM** phase one may change the REMIO interface address via the **Set_Slave_Address** function.

Any other type of message will be rejected during the Parameterisation wait phase.

Important!



REMIO parameterisation is fixed and unique for all units

Configuration

This is the **wait phase for the configuration message (WCFG)**.

The configuration message specifies the structure of the Input and Output Buffer.

Both Parameterisation (**Set_Prm**) and the diagnostic request (**Slave_Diag**) are allowed.

Any other type of message will be rejected during the configuration wait phase.

In any particular installation, the REMIO interface can only receive a change in configuration (**Check_Cfg**) from the Master which has set the parameters.

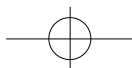

Communication

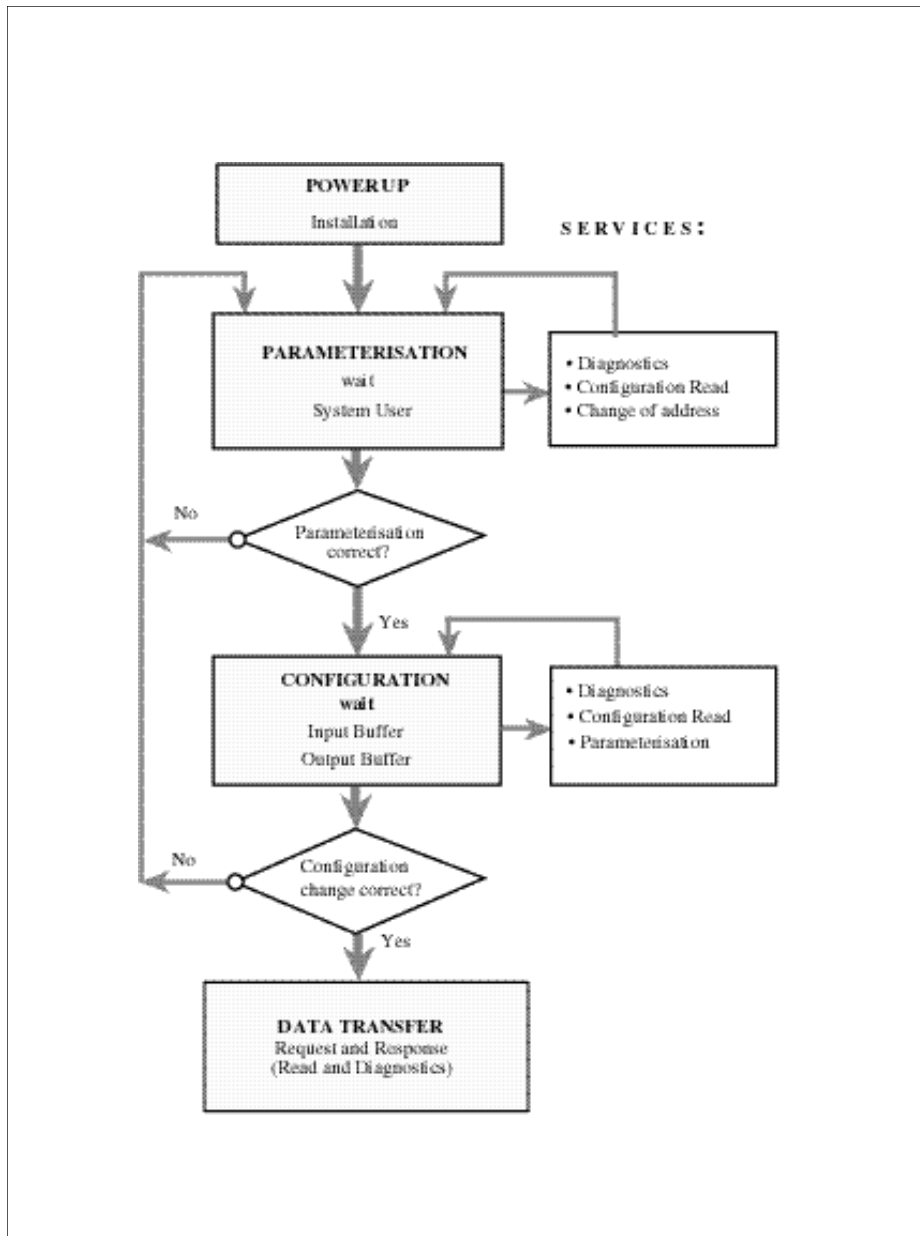

Figure 3-2 State diagram of Read/Write process in Profibus-DP protocol.



Data transfer

If Parameterisation and Configuration have been accepted, the data transfer phase (**DXCHG**) is reached and the REMIO interface is ready to transfer data to the Master which has configured and parameterised it.

Functions which are permitted during the **DXCHG** phase are as follows:

- Diagnostic (**Slave_Diag**)
- Parameterisation and Configuration:
 - Configuration read (**Get_Cfg**)
 - Configuration check (**Check_Cfg**)
 - Parameterisation (**Set_Prm**)
- Process data transfer:
 - Request and Response (**Data_Exchange**)
 - Multiple data read (**Read_Input**)
 - Re-read of outputs (**Read_Output**)
- Control of transmission modes (**Global_Control**).

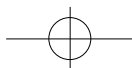
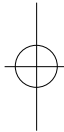
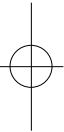



Communication

THE DEVICENET™ PROTOCOL

The **DeviceNet™** protocol is a serial communications protocol designed for communications between simple industrial devices and their monitoring or control units.

Important!

A detailed description of DeviceNet™ protocol operation is given in the Manual 'REMIO: DeviceNet™ Communications Manual', part no. HA 176272 ENG.

All REMIO operating and communications variables are considered as '**DeviceNet™ Objects**'.

The REMIO interface is in the set of components called '**Group 2 Only Pre-defined Master/Slave Devices**' according to the **DeviceNet™ 2.0** specification.

All the **DeviceNet™ Objects** and their **attributes** are accessible by the '**Explicit Messaging Connection**' according to the rules set by the Specification.

REMIO TPO outputs appear in the form of Objects called '**REMIO Variables**'

A global transfer of REMIO TPO variables is possible via the '**Poll I/O Connection**' (Fragmentation supported).

Transmission rates

In DeviceNet™ protocol, the transmission rate is **configurable** via the mini-switches (see Chapter 4, Configuration):

125 kbaud
250 kbaud
500 kbaud.

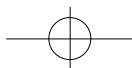

Error codes

As soon as the Slave detects an error in the Master's request, an error code is used in the **response frame**.

The code for 'General Error Service' is **14_{HEX}**

Error codes (in HEX)	Error type
2	Resource unavailable
8	Service not supported
9	Invalid attribute value (data value outside definition)
0B	Already in requested mode (state)
0C	Object state conflict
0E	Attribute not modifiable
0F	Privilege violation (access refused)
10	Device state conflict
11	(Reply) data too large
13	Insufficient data
14	Attribute not supported (not authorised)
15	Too much data
16	Object does not exist
18	No stored attribute data
19	Storage failure
1F	Vendor specific error
20	Invalid parameter

Table 3-4 Meaning of DeviceNet™ error codes

Communication

Addressing

The '**MAC ID**' device address (**REMIO** address on the bus used) is set at configuration time via the communications bus using the '**Explicit Messaging Connection**' of the '**Object Device_Net™**'.

Important!



As **shipped from the factory**, the REMIO default **device address** is configured as **32** (decimal).

This address may be **reconfigured** by the user via the **digital link**.

In normal operation, device addresses from **0** to **63** may be used.

Important!



Make sure that there is **only one unit** assigned to each device address.

The '**REMIO Variables**' corresponding to the **TPO Outputs** on the REMIO interface are members of the set '**DeviceNet™ USINT**', able to be manipulated by DeviceNet™ protocol access services '**GET_Attribute_Single**' & '**SET_Attribute_Single**'.

REMIO Variables		TPO outputs		Identifier (decimal)
Module	Port	Output No.	Terminal No.	
Base Module	Port 1	1 to 4 5 to 8	2 to 5 8 to 11	from 7 to 10 from 11 to 14
	Port 2	9 to 12 13 to 16	2 to 5 8 to 11	from 15 to 18 from 19 to 22
1st Optional Module	Port 3	17 to 20 21 to 24	2 to 5 8 to 11	from 23 to 26 from 27 to 30
	Port 4	25 to 28 29 to 32	2 to 5 8 to 11	from 31 to 34 from 35 to 38
2nd Optional Module	Port 5	33 to 36 37 to 40	2 to 5 8 to 11	from 39 to 42 from 43 to 46
	Port 6	41 to 44 45 to 48	2 to 5 8 to 11	from 47 to 50 from 51 to 54

Table 3-5 Identification of 'TPO output REMIO variables' in DeviceNet™ protocol

Permissible values for '**TPO output REMIO variables**' range from:

0 to **255** (decimal)

(00_{HEX} to FF_{HEX})

which constrains the data value at each of these addresses to one byte (**8 bits**).



State diagram for operation

The REMIO interface state diagram comprises **four states** (see Figure 3-3):

- powering up
- auto test
- waiting for configuration (if necessary)
- data transfer of REMIO DeviceNet™ variables.

Powering up

After each power-up, the unit enters an **Initialisation phase**.

Auto test

After initialisation, if all the **internal resources** and the **stored configuration** are **valid**, the REMIO interface enters a state which allows communications to take place.

If this is **not the case**, the REMIO interface can adopt:

- a **state of waiting for configuration** (if necessary) or
- **operation shut down** in the case of a **non-recoverable error**.

Configuration

The configuration necessary for operation of the DeviceNet® REMIO interface is described in the manual 'REMIO: DeviceNet® Communications Manual', part no. HA176272 ENG.

Operation

This is the normal state of the REMIO interface, in which it is ready to transfer data to the link Master.

Operation shut down

In the event of a non-recoverable fault, the REMIO interface changes to a **non-active state**, from which only the sequence of:

- switching **off, then**
- switching **on**

can reset the state, once **the fault** has been **rectified**.

Examples of non-recoverable faults:

- the unit configured to an address **already assigned** to another unit on the same bus
- internal operating problem.

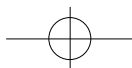

Communication

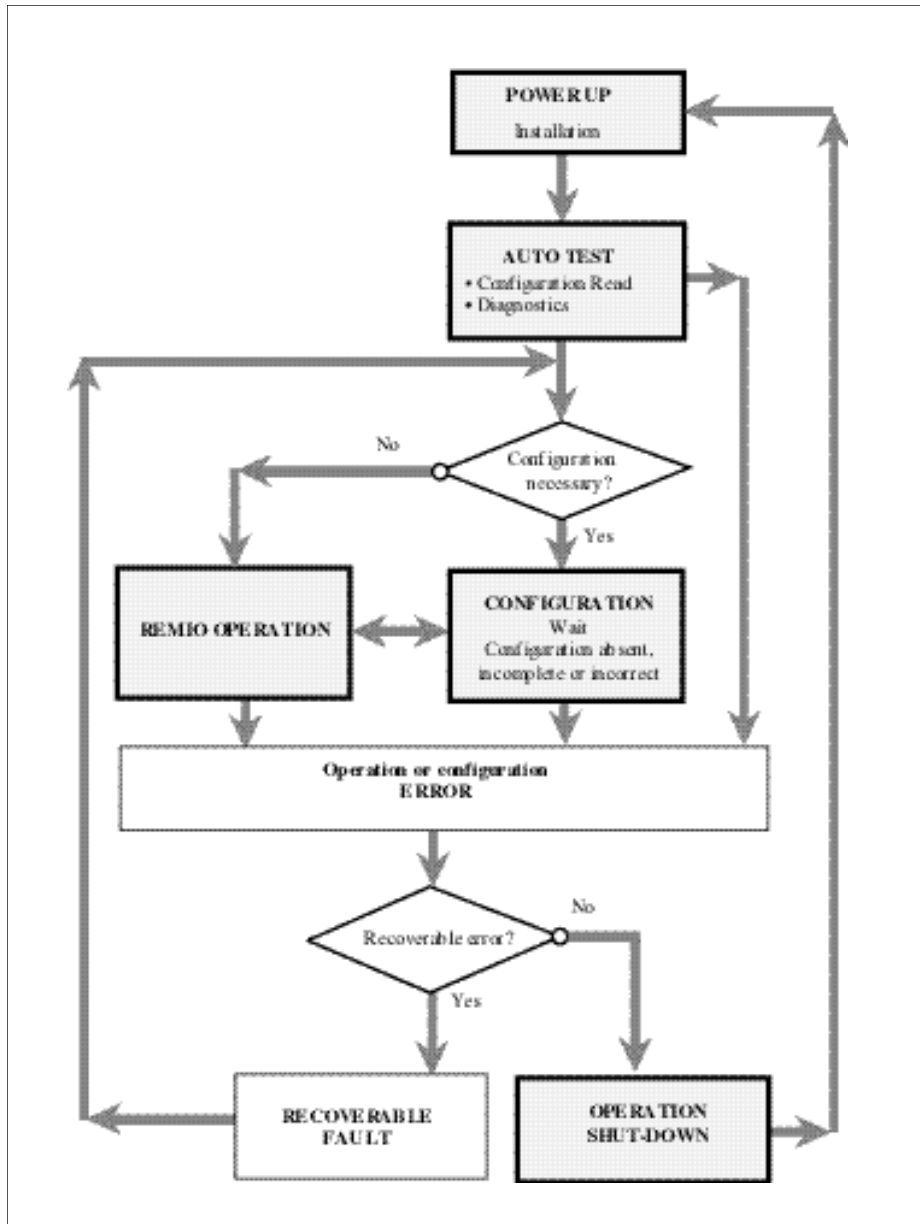

Figure 3-3 Operating state diagram for REMIO in DeviceNet™ protocol



Chapter 4

CONFIGURATION

Contents	Page
General introduction.....	4-2
Transmission rate.....	4-4
Termination resistors.....	4-5
Modbus® & Profibus-DP protocol.....	4-5
Devicenet™ protocol.....	4-6

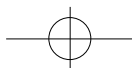
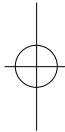
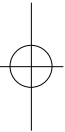



Configuration

Chapter 4 CONFIGURATION

GENERAL INTRODUCTION

The REMIO interface is configured using the **SW1** mini-switches located on the top of the unit.

Viewed **from above**, the **ON** position is shown **to the left** of the switches (front panel of product facing you).

The **SW1** mini-switches determine the transmission rate and the communications bus termination resistors.

Mini-switch	Function according to protocol		
	Modbus®	Profibus-DP	DeviceNet™
SW1.1	Port configuration as outputs*	Port configuration as outputs*	Port configuration as outputs*
SW1.2	Transmission rate	Not used	Transmission rate
SW1.3	Bus termination/ polarisation	Bus termination/ polarisation	Transmission rate
SW1.4	Bus termination/ polarisation	Bus termination/ polarisation	Not used

Table 4-1 Function of configuration mini-switches

*) As shipped from the factory, the position of SW1.1 is **ON**

Important!



In the REMIO TPO version, the position of **SW1.1** must always be **ON**.

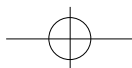

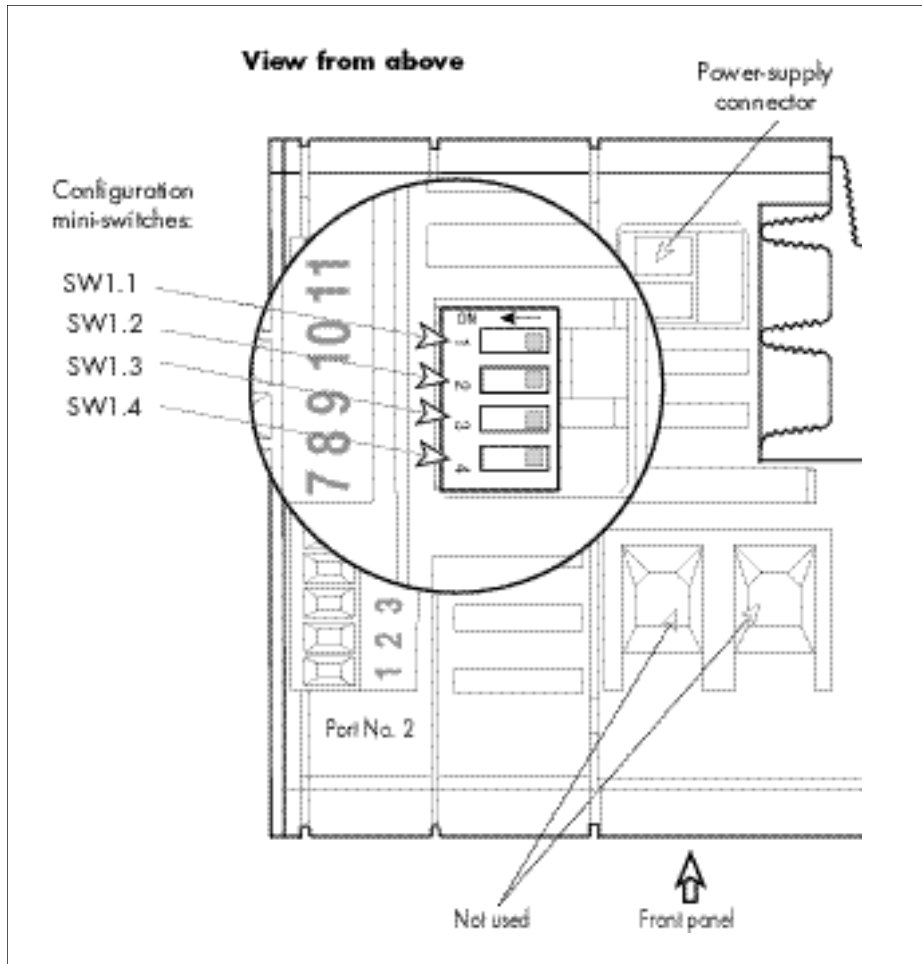

Figure 4-1 Layout of configuration mini-switches

SW1 mini-switch positions:

ON = the mini-switch is to the left (direction of arrow)

OFF = the mini-switch is to the right

(view from above, front panel towards you)

Configuration

TRANSMISSION RATE

The transmission rate is configured by:

- the SW1.2 mini-switch for Modbus® protocol
- the SW1.2 & SW1.3 mini-switches for DeviceNet™ protocol.

In Profibus-DP protocol, the transmission rate is defined by the link Master; REMIO baud rate setting is automatic and does not require any configuration to the bus.

Protocol	Transmission rate (kbaud)	Mini-switch position	
		SW1.2	SW1.3
Modbus®	9.6 19.2	OFF ON	Used for bus termination configuration
DeviceNet™	125 250 500	OFF ON OFF	OFF OFF ON
Profibus-DP	up to 1500	Not used: auto selection	Used for bus termination configuration

Table 4-2 Transmission rate configuration

TERMINATION RESISTORS

Modbus® & Profibus-DP protocols

The communications bus must be fitted with termination resistors at each end:

- a line impedance **matching resistor**
- two RS485 bus **polarisation resistors**.

Mini-switches **SW1.3** & **SW1.4**, located on the top of the REMIO interface, allow internal resistors to be connected at the end of the communications bus.

Important!



Only the **last unit** on the communications bus should be fitted with impedance matching resistors.
If the last unit on the bus is the **REMIO**, its mini-switches **SW1.3** & **SW1.4** should be in the **ON** position.

For all **other** REMIO units on the same communications bus, mini-switches **SW1.3** & **SW1.4** should be in the **OFF** position.
The positions of **SW1.3** & **SW1.4** should **always match**.

As **shipped from the factory**, mini-switches **SW1.3** & **SW1.4** are **OFF**.

The matching resistor value depends on the characteristic impedance of the line (120Ω to 220Ω). The REMIO matching resistor is **220Ω**.
The polarisation resistors are **390Ω** connected to both power rails.

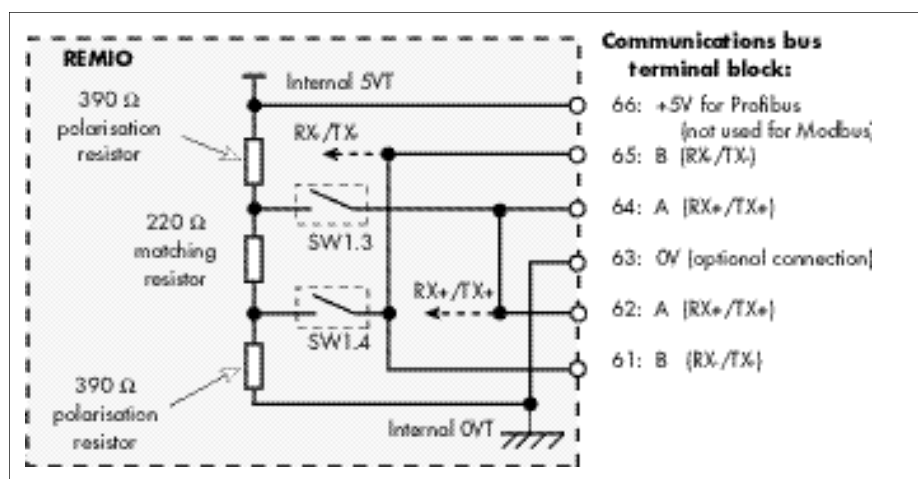

Figure 4-2 Termination resistor configuration diagram (Modbus® and Profibus-DP)



Configuration

DeviceNet™ protocol

The communications bus must be fitted with a line impedance **matching resistor** at each end.

The **CAN** bus used in DeviceNet™ protocol does not require polarisation resistors, because bus operation is defined by impedance.

Mini-switch **SW1.4**, located on the top of the unit, allows an internal resistor to be connected at the end of the communications bus.

Important!



Only the **last unit** on the communications bus should be fitted with an impedance matching resistor.

The position of the mini-switch **SW1.4** does not matter.

The matching resistor value depends on the characteristic impedance of the CAN bus.

The REMIO matching resistor is **120Ω** in the DeviceNet™ protocol.

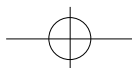
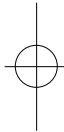
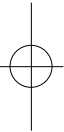



Chapter 5

OPERATION

Contents	Page
Thyristor firing modes	5-2
'Fast cycling' mode	5-3
'Advanced single-cycle' mode	5-5
LED operation	5-8
MODBUS® and PROFIBUS-DP protocols	5-8
DEVICENET™ protocol	5-9

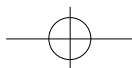
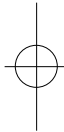
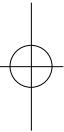



Operation

Chapter 5 OPERATION

THYRISTOR FIRING MODES

General introduction

The TPO version of the REMIO communications interface has two thyristor firing modes for the power units controlled (SSRs) :

- Fast cycling
- Advanced Single-cycle

The firing **mode** is **selected** by means of the REMIO power supply feed.

A **DC** voltage supply (24Vdc -15%, +25%) sets thyristor firing in '8-cycle' **Fast cycling** mode (see next page)

An **AC** voltage supply (24Vac -15%, +10%) sets thyristor firing in **Advanced Single-cycle** mode (see page 5-5).

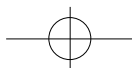
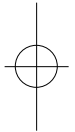
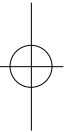

'FAST CYCLING' MODE

Fast cycling mode is a **duty cycle** mode which consists of supplying a series of **complete mains voltage cycles** to the load.

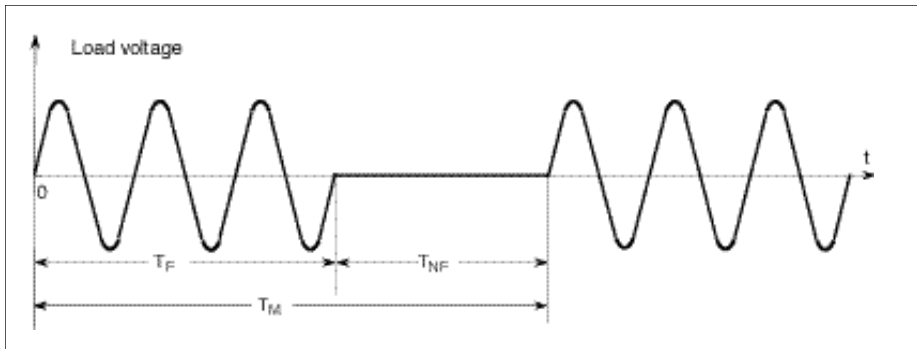

Figure 5-1 'Fast cycling' mode
(T_F - firing time; T_{NF} - non-firing time; T_M - modulation time)

Thyristor firing and non-firing are synchronised with the mains and, for a resistive load, are performed **at zero** voltage.

This type of firing eliminates steep rates of voltage applied to the load, **minimises interference** to the mains supply and, above all, avoids generating radio frequency interference (RFI).

In '**Fast cycling**' mode, the power delivered to the load depends on the firing time T_F and the non-firing time T_{NF} .

The load power is proportional to the firing rate (τ) which is defined by the ratio of the firing time T_F to the modulation time $T_M = T_F + T_{NF}$

The firing rate (or duty cycle) is expressed by the following ratio:

$$\tau = \frac{T_F}{T_F + T_{NF}} = \frac{T_F}{T_M}$$

The power delivered to the load can be expressed by:

$$P = \tau \cdot P_{MAX}$$

Where P_{MAX} represents the load power for full thyristor firing.



Operation

The modulation time in 'Fast cycling' mode is **variable** according to the power setpoint.

- At **50%** of maximum setpoint ($\tau = 50\%$), modulation time comprises:
 - **8 firing cycles**
 - **8 non-firing cycles**.
- For a zone **less than 50%** of maximum setpoint ($t < 50\%$):
 - **firing time remains constant at 8 mains cycles**
 - non-firing time increases and, as a consequence,
 - modulation time increases also.
- For a zone **greater than 50%** of maximum setpoint ($t > 50\%$):
 - **non-firing time remains constant at 8 mains cycles**
 - firing time increases and, as a consequence,
 - modulation time increases also.

As a result of this type of modulation, REMIO offers precision control which adapts to each setpoint zone.

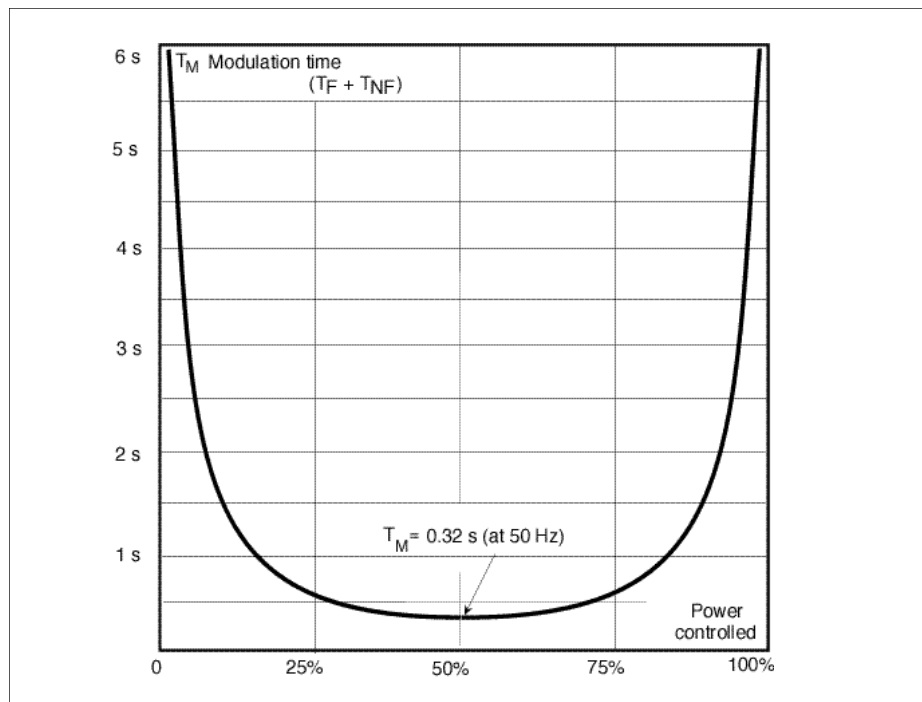
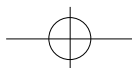

Figure 5-2 Modulation time as a function of power in 'Fast cycling'



'ADVANCED SINGLE-CYCLE' MODE

The Fast cycling mode with a single firing or non-firing cycle is called 'Single-cycle' (or 'Standard Single-cycle').

In 'Standard Single-cycle', the unit of thyristor firing or non-firing is **one mains cycle**.

In order to minimise power fluctuations during modulation time, the '**Advanced Single-cycle**' thyristor firing mode uses **half-cycle** units for firing or non-firing.

- For $\tau = 50\%$, firing and non-firing times each correspond to **one mains cycle** (see Figure 5-3).
- For setpoints less than or greater than 50%, firing and non-firing times are calculated to **within one half-cycle**.

This firing mode considerably reduces modulation time compared to the firing mode by complete cycles. Control performance is enhanced and fluctuations in the controlled power are reduced as a consequence of **more rapid modulation**.

'Advanced Single-cycle' firing mode **reduces flickering** in short-wave infrared elements and thus minimises resulting visual nuisance.

To avoid the DC component, the control system **adjusts the number of positive and negative half-cycles**.

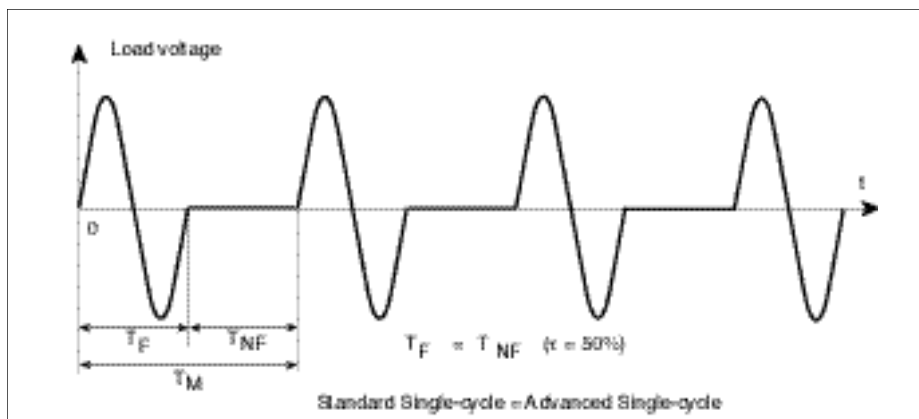

Figure 5-3 'Single-cycle' and 'Advanced Single-cycle' firing modes with $\tau = 50\%$ ($T_F = T_{NF}$)



Operation

Figure 5-4 shows a firing example with a **33%** firing rate in 'Standard Single-cycle' and 'Advanced Single-cycle' modes.

As for any firing zone **less than 50%** of the maximum setpoint ($\tau < 50\%$):

- for 'Standard Single-cycle', **firing time** is fixed at **one mains cycle**
- for 'Advanced Single-cycle', **firing time** is fixed at **one mains half-cycle**.

Setpoint changes cause variation in firing time. This has the effect of varying the modulation period.

As the figure below illustrates, 'Advanced Single-cycle' firing mode considerably reduces modulation time compared to firing by complete cycles. Control performance is enhanced as a result of **more rapid modulation**.

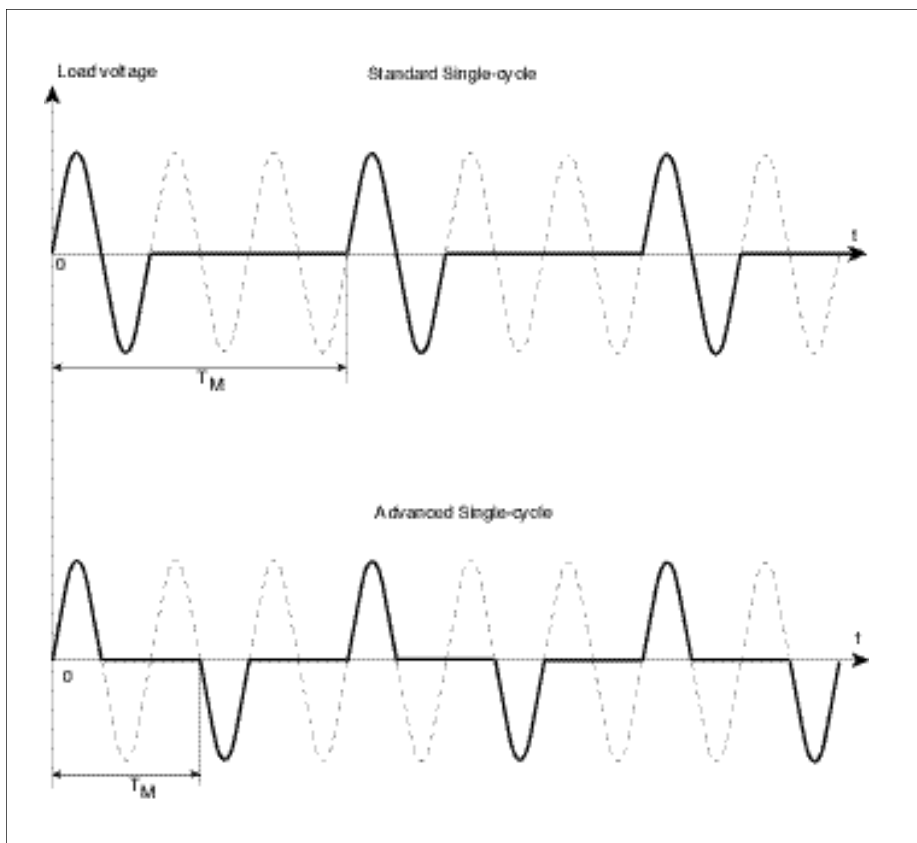

Figure 5-4 'Single-cycle' and 'Advanced Single-cycle' firing modes with $\tau = 33\%$ ($T_{NF} = 2T_F$)

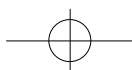



Figure 5-5 shows a firing example with a **66%** firing rate in 'Standard Single-cycle' and 'Advanced Single-cycle' modes.

As for any firing zone **greater than 50%** of the maximum setpoint ($\tau > 50\%$):

- for 'Standard Single-cycle', **non-firing time** is fixed at **one mains cycle**
- for 'Advanced Single-cycle', **non-firing time** is fixed at **one mains half-cycle**.

Setpoint changes cause variation in firing time. This has the effect of varying the modulation period, as **mains half-cycles** are the unit of firing or non-firing in 'Advanced Single-cycle' mode.

As the figure below illustrates, 'Advanced Single-cycle' mode considerably reduces modulation time compared to firing **by complete cycles**. Control performance is enhanced as a result of **more rapid modulation**.

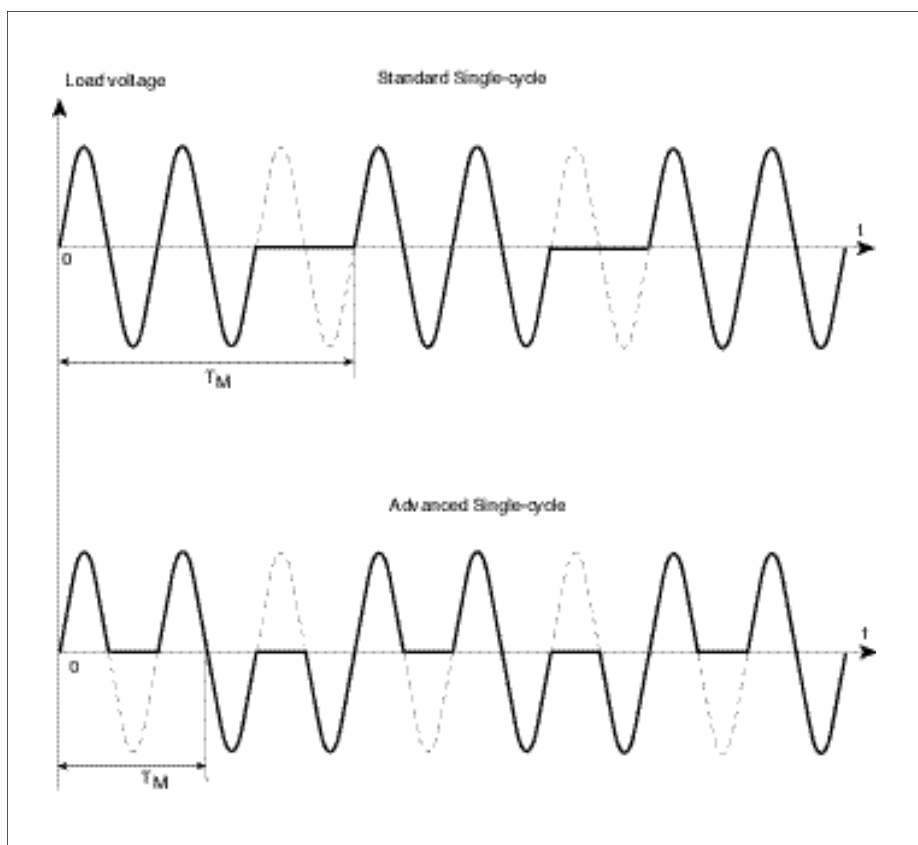
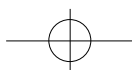

Figure 5-5 'Single-cycle' and 'Advanced Single-cycle' firing modes with $\tau = 66\%$ ($T_F = 2T_{NF}$)



Operation

LED OPERATION

The REMIO has diagnostic **LEDs** on the front panel.

The Base Module comprises:

- two LEDs indicating the communications state and
- one LED indicating whether the power supply is present.

The **green 'ON'** power supply LED on each module **is lit** if this module (base module as well as the optional module) is **supplied with power**.

The **green 'ON' LED** is not lit if the module **power supply is cut**.

Modbus® and Profibus-DP protocols

Two LEDs are used to diagnose the state of the communications bus:

- the **green LED** labelled '**Data Exchg**'
- the **red LED** labelled '**No comms**'.

LED Operation		Diagnostics
Data Exchg (Green)	No comms (Red)	
On	Off	Normal data transfer The communications bus is active and duration of the parameter 'Time_out' has not elapsed since the last communications frame.
Off	On	Communications disrupted Bus inactive or duration of the parameter 'Time_out' has elapsed.
Off	Off	No power supply The REMIO is not communicating

Table 5-1 Diagnostics in Modbus® and Profibus-DP protocols by REMIO front panel LEDs

DeviceNet™ protocol

Two **bi-coloured** LEDs are used to diagnose the state of the REMIO and the communications bus:

- the green/red LED labelled '**Network Status**' indicates the communications bus state.
- the green/red LED labelled '**Module Status**' indicates the REMIO state.

The LEDs operate independently of one another.

LED operation	LED labelling and function	
	'Module Status' REMIO diagnostics	'Network Status' Comms bus diagnostics
OFF	REMIO not supplied	REMIO not supplied
Green - Red - Green	Start up auto test	Start up auto test
Flashing green	REMIO in wait mode: configuration absent, incomplete or incorrect	Communications OK, REMIO not assigned to a Master
Flashing red	Auto recoverable fault	Time Out elapsed
Red on	REMIO out of service	Communications problem

Table 5-2 Diagnostics in DeviceNet' protocol by 'Module Status' and 'Network Status' LEDs



EUROTHERM LIMITED

<http://www.eurotherm.co.uk>

UK SALES OFFICE

Eurotherm Limited

Faraday Close, Durrington

Worthing

West Sussex BN13 3PL

Telephone Sales: (01903) 695888

Technical: (01903) 695777

Fax: (01903) 695666

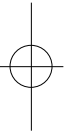

Sales and support in over 30 countries worldwide

For countries not listed overleaf, enquiries/orders to:

Eurotherm Limited

Export Dept.,

Faraday Close, Durrington, Worthing

West Sussex, BN13 3PL

Telephone (01903) 268500

Fax (01903) 265982

