

**WASHING MACHINE USER
MANUAL**

**MASINA DE SPALAT
MANUAL DE UTILIZARE**

CUPRINS

SECTIUNEA 1: INAINTE DE UTILIZARE

- Attentionari de siguranta
- Recomandari

SECTIUNEA 2: INSTALARE

- Indepartarea suruburilor de la transport
- Reglarea picioarelor
- Conectarea electrica
- Conectarea sistemului de alimentare cu apa
- Conectarea sistemului de evacuare a apei

SECTIUNEA 3: SPECIFICATII TEHNICE

SECTIUNEA 4: PANOU DE COMANDA

- Buton Start/Pause
- Indicatori luminosi
- Butoane
- Butonul de reglare a temperaturii
- Butonul de programe

SECTIUNEA 5: SPALAREA RUFELOR

- Inainte de spalare
- Operarea masinii de spalare

SECTIUNEA 6: CURATARE SI INTRETINERE

- Filtre la intrarea apei
- Filtru de pompare
- Sertarul pentru detergent
- Fisa pentru sifon
- Cabinet
- Cuva
- Prevenirea/ Indepartarea ruginii

SECTIUNEA 7: INFORMATII PRACTICE

SECTIUNEA 8: EVITAREA MICILOR ERORI

SECTIUNEA 9: SISTEMUL DE DETECTARE AUTOMATA A ERORILOR

SECTIUNEA 10: SIMBOLURI INTERNATIONALE PENTRU SPALARE

SECTIUNEA 1: INAINTE DE UTILIZARE ATENTIONARI DE SIGURANTA

- Nu utilizati un trilpu-stecher sau prelungitor.
- Nu introduceti stecherul in priza daca cablul prezinta defectiuni.
- Daca cablul este defect, trebuie inlocuit de catre producator sau un centru autorizat, pentru prevenirea accidentelor.
- Cand scoateti din priza, trageti de stecher, niciodata de cablu.
- Nu introduceti stecherul in priza daca aveti mainile ude.
- Nu atingeti masina cu mainile sau picioarele ude.
- Nu deschideti compartimentul pentru detergent in timpul functionarii.
- Nu incercati sa deschideti cu forta usa masinii in timpul functionarii.
- Nu atingeti furtunurile in timpul utilizarii, datorita temperaturii ridicate care se poate atinge in cursul functionarii masinii.
- In caz de eroare sau defectiune, intai scoateti masina din priza si inchideti robinetul de apa. Nu incercati sa o reparati singuri. Va rugam adresati-va celui mai apropiat centru de service.
- Nu uitati ca ambalajul in care primiti masina de spalat poate fi periculos pentru copii ; nu le permiteti sa se joace cu acesta.
- Nu lasati copiii sa se joace la masina de spalat.
- Feriti-va animalele de companie de masina de spalat.
- Masina de spalat trebuie utilizata doar de catre adulti, in urma asimilarii informatiilor din acest manual.
- Masina de spalat este destinata exclusiv uzului casnic. Pierdeti garantia daca utilizati acest aparat in scopuri comerciale.
- Aparatul electrocasnic nu trebuie pus pe un covor care poate bloca ventilatia cu aer pe partea de fund.

RECOMANDARI

- Daca ramane in contact cu aerul pentru mult timp, detergentul sau balsamul de rufe din compartimentul special se va usca si se va lipi de sertar. Pentru a evita acest lucru, introduceti detergentul sau balsamul chiar inainte de utilizarea masinii.
- Se recomanda utilizarea programului de pre-spalare numai in cazul rufelor foarte murdare.
- Va rugam sa nu depasiti capacitatea maxima de incarcare cu rufe.
- Daca nu folositi masina un timp indelungat, deconectati-o de la priza, inchideti robinetul de alimentare cu apa si lasati usa cuvei deschisa, pentru a permite uscarea interioara si a preveni formarea mirosurilor neplacute.
- Acest aparat nu este destinat utilizării de către persoane (inclusiv copii) cu capacități fizice, senzoriale sau mintale reduse, sau care nu au experiența și cunoștințele necesare, cu excepția cazului în care sunt supravegheate sau instruite de către persoana responsabilă cu siguranța acestora. Copiii trebuie supravegheați pentru a nu se juca cu aparatul.

- Ca o consecinta a procedurilor de control, e posibil sa mai ramana putina apa in masina. Acest lucru nu constituie un pericol.

SECTIUNEA 2: INSTALARE

Inainte de a folosi masina de spalat, fiti atent la urmatoarele chestiuni:

INDEPARTAREA SURUBURILOR DE LA TRANSPORT

- Suruburile de la transport, situate in partea posterioara a masinii, trebuie indepartate inainte de utilizarea propriu-zisa a masinii de spalat.
- Desfaceti suruburile rotindu-le in sensul invers acelor de ceas, cu o surubelnita adecvata. (DESEN-1)
- Indepartati suruburile prin tragere. (DESEN-2)
- In gaurile lasate dupa desfacerea suruburilor, introduceti dopurile de plastic, pe care le gasiti in geanta cu accesorii. (DESEN-3)
- Suruburile de la transport, pe care le-ati indepartat, trebuie pastrate la indemana, in eventualitatea in care trebuie sa transportati din nou masina catre o alta locatie.



DESEN-1

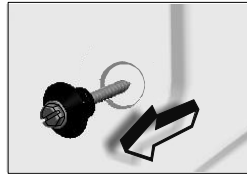

DESEN-2

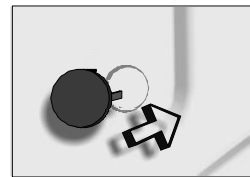

DESEN-3

REGLAREA PICIOARELOR

- Nu instalati masina pe covoare, carpete sau suprafete similare.
- Pentru ca masina Dvs sa functioneze silentios si sa nu aiba vibratii, trebuie asezata pe o suprafata orizontala, nealunecoasa si rezistenta.
- Puteti regla echilibrul in care sta masina, prin reglarea inaltimii picioarelor.
- Mai intai, desurubati capacul de plastic, de reglare.
- Reglati inaltimea picioarelor (in sus si in jos).

- Cand ati reusit sa echilibrati masina, strangeti capacele de plastic, prin rotire.
- Nu asezati sub masina cartoane, bucati de lemn sau materiale similare pentru a regla pozitia masinii, fata de neregularitatile suprafetei pe care sta.

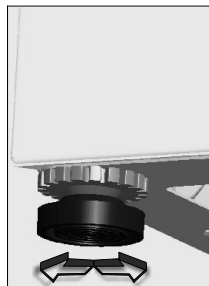
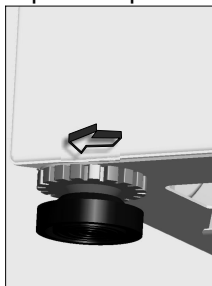

CONECTAREA ELECTRICA

- Masina Dvs de spaal functioneaza la 220-240 V si 50 Hz.
- Un stecher special cu impamantare a fost atasat la cablul masinii dvs de spalat. Acest stecher trebuie conectat neaparat la o priza cu impamantare cu 10 Amperi. Valoarea fluxului sigurantei de la linia electrica la care este atasata priza trebuie sa aiba tot 10 Amperi. Daca nu aveti astfel de prize si sigurante in casa Dvs, apelati la un electrician calificat pentru a face aceste modificari.
- **Compania noastra nu este responsabila pentru defectiunile aparute drept consecinta a utilizarii masinii de spalat fara impamantare.**

CONECTAREA SISTEMULUI DE ALIMENTARE CU APA

- Masina Dvs este prevazuta cu un singur orificiu de intrare, si anume pentru apa rece.
- Pentru a preveni scurgeri de apa la punctele de conectare/ imbinare, folositi garnitura inclusa in pachetul unde se afla furtunul. (Fixati garnitura la furtunul de apa, la capatul dinspre robinet).
- Conectati un capat al furtunului de apa la orificiul de intrare din spatele masinii, si celalalt capat la robinet. Daca aveti incertitudini asupra capatului corect, apelati la un instalator profesionist, pentru a efectua conectarea la sursa de apa in mod corect.
- Eficienta masinii sporeste daca apa are o presiune de 0,1-1 Mpa. (0,1 MPa inseamna un debit de 8 litri pe minut, cu robinetul deschis complet).
- Dupa ce terminati conectarile, verificati daca exista scurgeri de apa la punctele de imbinare, deschizand complet robinetul.
- Asigurati-va ca furtunurile de apa nu sunt indoite, sparte sau strivite de vreun obiect.
- Montati furtunurile de apa la un robinet de apa 3"/4.

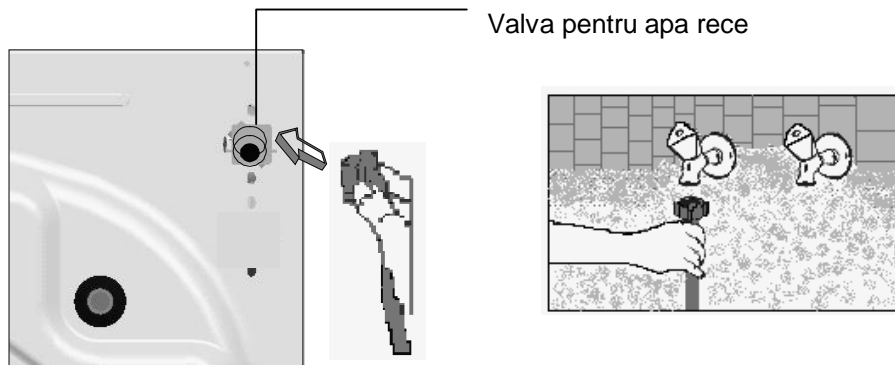

CONECTAREA SISTEMULUI DE EVACUARE A APEI

- Asigurati-va ca furtunurile de apa nu sunt indoite, intoarse, strivite sau suprasolicitate prin intindere excesiva.
- Furtunul de evacuare trebuie montat la o inaltime de minim 60 cm, maxim 100 cm fata de sol.
- Capatul furtunului de evacuare poate fi orientat direct catre orificiul de scurgere al apei murdare sau cu ajutorul unui dispozitiv, se poate monta in sifonul de la chiuveta.
- Nu incercati sa prelungiti furtunul de evacuare, adaugand alte componente aditionale.

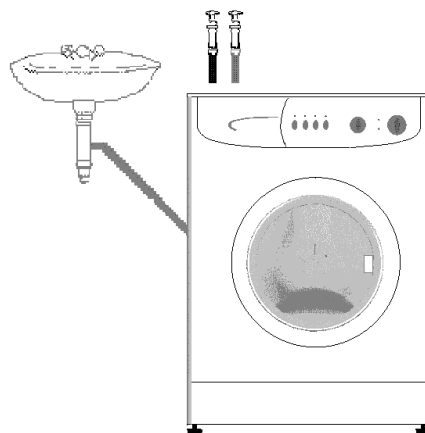

SECTIUNEA 3:SPECIFICATII TEHNICE

	442/542/ 642/842/1042
Capacitate maxima de rufe uscate (kg)	5
Cantitate de rufe recomandata (kg)	4,5
Inaltime (cm)	85
Latime (cm)	59,6
Adancime (cm)	51
Ciclu maxim de stoarcere (rotatii/ min) *	400/500/ 600/800/1000

(*) ciclul maxim de stoarcere variaza in functie de modelul ales.

SECTIUNEA 4: PANOU DE CONTROL

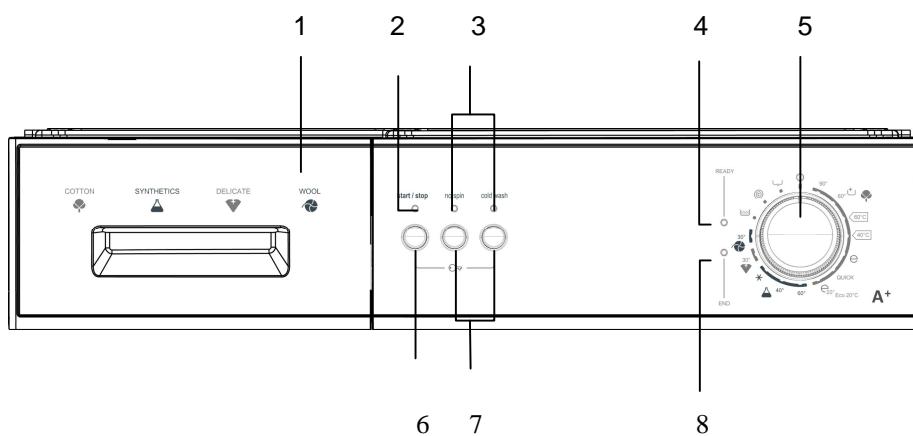

1-Compartiment pentru detergent
2-Indicator Start/pause
3-Indicatori luminosi pentru diverse functii
4-Indicator Setare program

5-Buton programe
6-Buton Start/pause
7-Butoane pentru diverse functii
8-Indicator Sfarsitul programului

BUTON START/PAUSE

start / stop Pentru a porni un program selectat sau a face o pauza pe durata functionarii.

ATENTIE!

Este necesar ca butonul de programe sa fie in pozitia O (Off/ inchis) inainte de a selecta un program sau de a schimba unul aflat in derulare.

INDICATORI LUMINOSI



Cand apasati butonul Start/Pause sau orice alt buton, lumina indicatorului corespunzator se aprinde. Acesta se stinge atunci cand apasati din nou butonul Start/Pause sau atunci cand procesul functiei selectate a luat sfarsit.

Indicatorii luminosi pot indica si o defectiune in sistem. Vezi pag. 9

BUTOANE FUNCTII

no spin

Fara stoarcere

Acest program este recomandat pentru rufele delicate, care nu ar trebui stoarse. Apasand acest buton, anulati ciclul de stoarcere, inclus in programul respectiv.

cold wash

Spalare cu apa rece

Daca apasati acest buton, rufele Dvs vor fi spalate cu apa rece. Cu aceasta functie, va puteti spala rufele foarte putin murdare, profitand astfel de un consum redus de energie electrica si apa.

ATENTIE!

Funcțiile variază în funcție de modelul achiziționat. Dacă ați uitat să folosiți funcții suplimentare și mașina începe ciclul de spălare, apăsați butonul pentru funcții suplimentare, dacă indicatorul acestuia este aprins. Funcțiile suplimentare se vor activa. Dacă indicatorul nu este aprins, funcțiile suplimentare nu vor fi activate.

BUTONUL DE PROGRAME

Cu acest buton, puteti selecta programu; cu care doriti sa spalati rufe. Puteti roti butonul in ambele directii. Trebuie sa fiti atenti la faptul ca semnul de setare de pe butonul de programe trebuie sa se afle exact in dreptul programului pe care doriti sa il selectati. Daca rotiti butonul in dreptul semnului O (Off/ inchis) in timp ce masina functioneaza, programul selectat de Dvs va ramane incomplet.

Bumbac 90°C
Bumbac 60°C cu prespalare
Bumbac 60°C <60°C
Bumbac 40°C <40°C
Spalare ecologica
Spalare rapida
Eco 20°
Sintetice 60°C
Sintetice 40°C
Sintetice –apa rece
Delicate 30°C
Lana 30°C
Clatire
Stoarcere
Evacuare
OFF/ Inchis

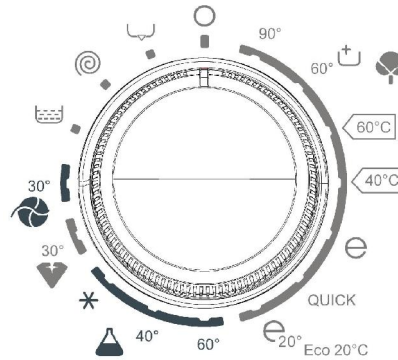

SECTIUNEA 5: SPALAREA RUFELOR

- Conectati masina la priza.
- Deschideti robinetul de apa.

Prima spalare

In urma testelor efectuate pe linia de productie, in fabrica, este posibil sa mai fi ramas o mica cantitate de apa in interiorul masinii Dvs de spalat. Se recomanda ca prima spalare sa se efectueze fara rufe inaintu, pentru ca aceasta apa sa poata fi evacuatata. Turnati o jumatate de masura de detergent universal in compartimentul 2 si selectati programul pentru Bumbac, la 90°C.

INAINTE DE SPALARE

Sortarea rufelor

- SORTati rufele in functie de: material (bumbac, sintetice, fibre delicate, lana, etc), temperatura recomandata pentru spalare (pe eticheta) si gradul de murdarie.
- Nu spalati niciodata rufele albe impreuna cu cele colorate.
- Hainele noi, colorate, e posibil sa se decoloreze la prima spalare, asa ca e recomandabil sa le spalati separat.
- Asigurati-va ca nu exista obiecte metalice in buzunarele hainelor Dvs.
- Inchideti fermoarele si nasturii hainelor.
- Indepartati carligele de plastic sau metal de la perdele/ draperii sau introduceti-le intr-o punga speciala pentru spalat si legati bine.

- Intoarceti pe dos hainele cum sunt: pantaloni, tricouri, maiouri.
- Rufe de dimensiuni mici, cum sunt sosetele si batistele, ar trebui introduse intr-o pungă speciala pentru spalare.



Maxim 90 °C



Maxim 60 °C



Maxim 30 °C



Nu se spala
in masina de spalat

Introducerea rufelor in masina

- Deschideti usa masinii de spalat.
- Asezati rufe in cuva, prin imprastiere.
- Introduceti fiecare rufa, pe rand.
- Cand inchideti usa masinii de spalat, asigurati-va ca nu s-a prins vreo rufa in usa.
- Inchideti usa masinii de spalat si asigurati-va ca ati inchis-o bine; in caz contrar, masina nu va incepe sa functioneze.

Introducerea detergentului

Cantitatea de detergent pe care o introduceti in masina depinde de urmatoarele criterii:

- Consumul de detergent se modifica in functie de gradul de murdarie al rufelor. Pentru rufe ușor murdare, nu efectuati prespalare si puneti o cantitate mica de detergent in compartimentul 2 al sertarului.
- Pentru rufe foarte murdare, selectati un program care include si prespalare, umpleti $\frac{1}{4}$ din detergent in compartimentul 1, si restul turnati-l in compartimentul 2 al sertarului.
- In masina de spalat, folositi numai detergenti special destinati masinilor automate. Cantitatile de detergent recomandate pentru rufe sunt inscise pe ambalajul detergentilor respectivi.
- Consumul de detergent creste direct proportional cu gradul de duritate al apei.
- Consumul de detergent creste direct proportional cu cantitatea de rufe introdusa in masina.
- Turnati balsamul de rufe in compartimentul special destinat din sertarul pentru detergent. NU depasiti nivelul MAX; altfel, balsamul se va raspandi in apa de spalat prin sifon.
- Balsamurile de rufe cu densitate mare trebuie diluate cu putina apa inainte de a fi turnate in masina de spalat, deoarece obstructiunea sifonului si se pierde in apa de spalat.

- Puteti folosi detergenti lichizi la toate programele fara prespalare. Turnati detergentul lichid in compartimentul 2 ; cantitatea acestuia depinde de recomandarile de pe ambalaj.

OPERAREA MASINII DE SPALAT

Selectarea programelor si caracteristicile acestora

Selectati programul si functiile suplimentare, in functie de rufele pe care doriti sa le spalati, conform Tabel- 1.

Start/Pause

Apasand acest buton, porniti programul pe care l-ati selectat sau il intrerupeti pe cel aflat in derulare.

Pornirea unui program

- Reglati butonul de programe pentru a selecta programul dorit.
- Indicatorul Setare program se va aprinde.
- Daca doriti, puteti selecta si una sau mai multe functii suplimentare.
- Porniti programul pe care l-ati selectat, apasand butonul Start/Pause.

Schimbarea unui program

Daca ati selectat un program si nu vreti sa il continuati:

- Apasati butonul Start/pause.
- Rotiti butonul de programe pana la pozitia O (off/ inchis).
- Rotiti butonul de programe pana in dreptul programului pe care il doriti. (consultati si Tabelul-1 pentru selectarea programului).
- Indicatorul Setare program se va aprinde.
- Apasati butonul Start/pause button, si programul nou selectat va incepe sa se deruleze.

Anularea unui program

Daca doriti sa terminati un program inainte de a ajunge la final:

- Apasati butonul Start/pause.
- Rotiti butonul de programe pana la pozitia O (off/ inchis).
- Rotiti butonul de programe la "Evacuare" sau "Stoarcere"
- Indicatorul Setare program se va aprinde.
- Porniti programul selectat prin apasarea butonului Start/pause.

Terminarea programului

- Masina de spalat se va opri automat atunci cand programul selectat de Dvs ajunge la final.
- Indicatorul Sfarsitul programului se va aprinde.
- Rotiti butonul de programe pana la pozitia O (off/ inchis).

- Usa se va debloca in cca 2 minute dupa terminarea programului. Deschideti usa, tragand manerul acesteia spre Dvs si scoateti rufele din cuva.
- Dupa ce scoateti toate rufele, lasati usa cuvei deschisa, pentru ca interiorul acesteia sa se usuce bine.
- Deconectati masina de spalare de la priza.
- Inchideti robinetul de apa.

ATENTIE!

Daca in timpul derularii unui program, alimentarea cu energie electrica se intrerupe in mod repetat, masina de spalare isi va continua programul de la etapa unde a fost intrerupta. Acest lucru nu dauneaza masinii de spalare.

Functia Interzis copii



Opțiunea de blocare pentru copii e folosită pentru a proteja ciclul de spălare de efectele atingerii nedorite a butoanelor în timpul ciclului. Opțiunea de blocare pentru copii se activează apăsând primul și cel de-al treilea buton de pe panoul de control timp de mai mult de trei secunde. Când opțiunea de blocare pentru copii e activată, LED-urile de pe butoanele de funcții clipesc pentru a indica faptul că opțiunea de blocare pentru copii e activă. Pentru a dezactiva opțiunea, aceleași butoane (primul și al treilea) trebuie apăsați din nou mai mult de trei secunde. Dezactivarea opțiunii e afișată prin clipirea LED-ului pe butonul de Pornire/Pauză.

SECTIUNEA 6: CURATARE SI INTRETINERE

- Deconectati masina de la priza.
- Inchideti robinetul de apa.

FILTRE LA INTRAREA APEI

La furtunul de alimentare cu apa, la capatul conectat la robinet exista filtre care impiedica intrarea particulelor de murdarie sau obiectelor straine in apa care ajunge in masina de spalare; la fel, si la orificiile de intrare a apei. Daca masina nu poate sa isi traga suficiente apa desi robinetul de apa este deschis, e necesar sa curatati aceste filtre.

PROGRAM	COMPART. DETERGENT	CAPACITATE MAXIMA RUFEE USCATE (kg)	TIPURI DE RUFEE	EXPLICATII
		442/ 542/ 642/842/1042		
BUMBAC 90°	2	5	Murdare, tesatura din bumbac sau in	Lenjerie de corp, lenjerie de pat, fete de masa, tricouri, camasi, prosoape (max.2,5 kg)
BUMBAC 60° (PRESPALARE)	1+2	5	Foarte murdare, din bumbac sau in, colorate	
BUMBAC 60° 	2	5	Murdare, din bumbac, in si colorate	
BUMBAC 40° 	2	5	Murdare, din bumbac, in si colorate	
SPALARE ECOLOGICA	2	5	Murdare, din bumbac, colorate si in	
SPALARE RAPIDA	2	2,5	Putin murdare, din bumbac, colorate si in	
ECO 20°	2	2,5	Putin murdare, din bumbac, colorate si in. Se spala fara ca masina sa incalzeasca apa.	
SINETICE 60°	2	3	Murdare, sintetice, sau tesaturi mixte, cu procent sintetic	Sosete sau bluze de nylon
SINETICE 40°	2	3	Putin murdare, sintetice, sau tesaturi mixte, cu procent sintetic	Sosete sau bluze de nylon
SINETICE APA RECE	2	3	Rufe delicate, putin murdare, sintetice, sau tesaturi mixte, cu procent sintetic. Se spala fara incalzirea apei.	Sosete sau bluze de nylon
DELICATE 30°	2	2	Rufe delicate, putin murdare, din bumbac, colorate, sintetice sau procent sintetic	Tesaturi mixte de matase, camasi, bluze, polyester, poliamida, tesaturi mixte.
LANA 30°	2	2	Rufe de lana murdare, care se pot spala si manual, si la masina	Toate tesaturile de lana

TABEL-1

PROGRAM	COMPART. DETERGENT	BUTON PENTRU FUNCTII SUPLIMENTARE	CAPACITATE MAXIMA RUFEE USCATE (kg)	TIPURI DE RUFEE	EXPLICATII
			442/542/642/842/1042		
CLATIRE	Cand aveti nevoie de o clatire suplimentara pentru rufele Dvs, dupa terminarea procesului de spalare, puteti folosi acest program pentru toate tipurile de rufe, indiferent de tesatura.				
STOARCERE	Cand aveti nevoie de o stoarcere suplimentara pentru rufele Dvs, dupa terminarea procesului de spalare, puteti folosi acest program pentru toate tipurile de rufe, indiferent de tesatura.				
EVACUARE	Acest program se foloseste pentru evacuarea apei murdare dupa incheierea procesului de spalare. Daca doriti ca apa din interiorul masinii sa fie evacuata inainte de terminarea programului de spalare, puteti folosi acest program.				

TABEL-1 CONTINUARE

(*) Puteti folosi balsam de rufe la oricare din aceste programe (exceptie: programele de stoarcere si evacuare a apei). Cand calculati cantitatea de balsam, consultati recomandarile producatorului balsamului respectiv. Turnati balsamul in compartimentul special prevazut  din cadrul sertarului pentru detergent..

Valorile duratei programului, a consumului de energie și de apă pot varia în funcție de greutatea și tipul încărcăturii, de funcțiile suplimentare selectate, de temperatura apei de la robinet și de cea ambientală.

- Scoateti furtunul de alimentare din spatele masinii.
- Scoateti filtrele cu un patent si frecati bine cu o perie.
- Curatati filtrele furtunului, situate la capatul dinspre robinet, dupa ce le scoateti manual, impreuna cu garnitura.
- Dupa ce curatati filtrele, asezati-le in pozitia in care erau initial.

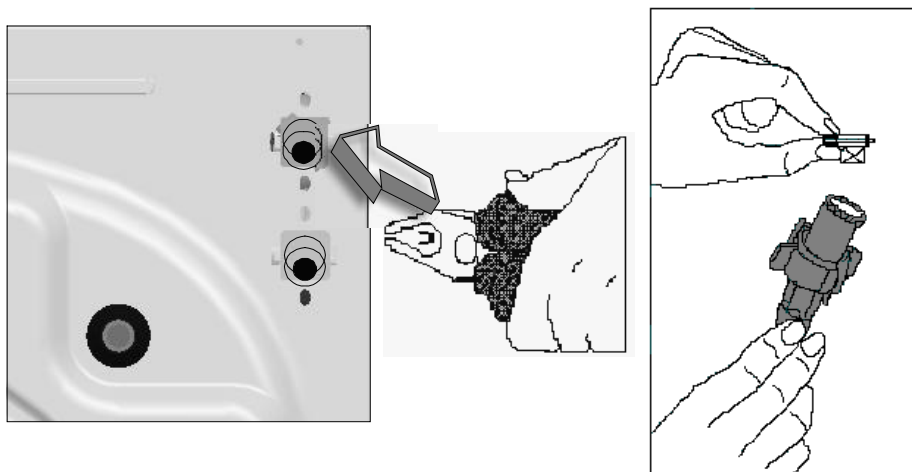

FILTRUL POMPEI

Sistemul filtrului pompei prelungeste durata de viata a pompei dumneavoastra, care este utilizata pentru drenarea apei murdare. Acesta impiedica intrarea calcarului in pompa. Se recomanda curatarea filtrului pompei la 2-3 luni. Pentru curatarea filtrului pompei:

- Deschideti capacul, tragand de maner.
- Inainte de deschiderea capacului filtrului, asezati un recipient in fata capacului filtrului pentru a impiedica scurgerea apei ramase in masina.
- Slabiti capacul filtrului prin rotirea acestuia in sens contrar acelor de ceasornic si scurgeti apa.
- Indepartati orice materii straine din filtru.
- Verificati manual rotirea pompei.
- Dupa curatarea pompei, fixati capacul filtrului prin rotirea acestuia in sensul acelor de ceasornic.
- Puneți capacul la loc.
- Nu uitati ca in cazul in care nu puneti bine la loc capacul filtrului, se va scurge apa.

⚠ ATENTIE!

Pericol de oparire!

Datorita faptului ca e posibil ca pompa sa fie inca fierbinte, asteptati intai sa se raceasca.

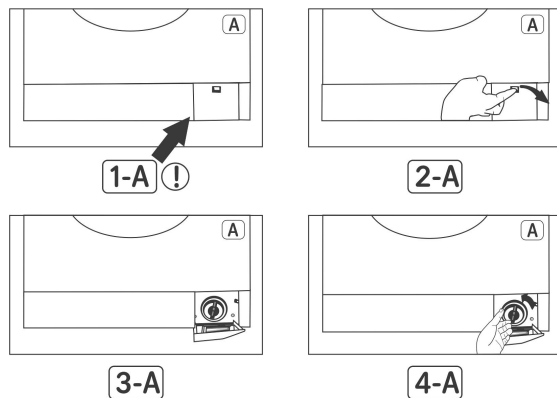

SERTARUL PENTRU DETERGENT

In timp, detergentii pot forma sedimente in sertarul de detergent Pentru a curata aceste sedimente, scoateti din cand in cand sertarul pentru detergent. Pentru aceasta:

- Trageti sertarul pana la capat (DESEN-1)
- Ridicati partea frontala a sertarului, continuati sa trageti, pana reusiti sa il scoateti afara (DESEN-2)
- Spalati-l cu o periuta de dinti mai veche si foarte multa apa..
- Dupa ce se usuca, asezati sertarul de detergent inapoi, urmand procedura inversa celei pe care ati folosit-o cand l-ati scos.

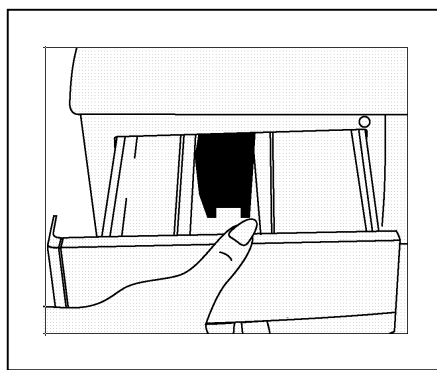

DESEN-1

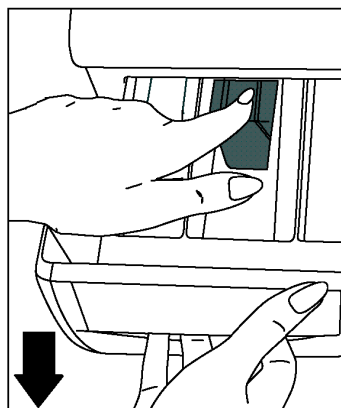

DESEN-2

FISA PENTRU SIFON

Scoateti sertarul pentru detergent. Scoateti fisa de la sifon si curatati cu grija reziduurile de balsam. Asezati apoi fisa in pozitia corecta. Verificati daca ati pozitionat-o bine.

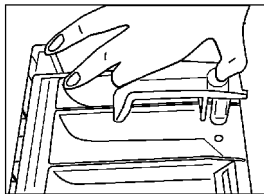

CABINETUL

Stergeti suprafata exterioara a cabinetului cu apa calduta si un detergent care sa nu dauneze acesteia. Clatiti cu apa curata si stergeti cu un material moale si uscat.

⚠ ATENTIE!

Daca masina este instalata intr-un loc unde temperatura camerei poate cobori sub 0 °C, urmati aceste instructiuni atunci cand nu utilizati masina :

- Conectati masina la priza.
- Inchideti robinetul de apa si deconectati furtunul de alimentare de la robinet.
- Asezati capatul furtunului de evacuare si al celui de alimentare jos, intr-un vas.
- Rotiti butonul de programe in dreptul ceui de Evacuare.
- Indicatorul Setare program se va aprinde.
- Porniti programul, apasandbutonul start/pause.
- Cand se termina programul (se aprinde indicatorul Terminare program), scoateti masina din priza.

Cand terminati acest proces, apa ramasa inaintu va fi evacuata, prevenindu-se astfel formarea de gheata in interiorul masinii. Cand veti utiliza din nou masina, asigurati-va ca temperatura mediului respectiv este mai mare de 0 °C.

CUVA

Nu lasati obiecte metalice (ace, agrafe, monezi) in interiorul masinii de spalat, deoarece vor favoriza formarea de rugina. Pentru a elimina petele de rugina, folositi un agent de curatare fara clor si urmati instructiunile producatorului respectivei substante. Nu folositi niciodata burete de sarma sau obiecte care pot produce zgarieturi, deoarece acestea favorizeaza la randul lor aparitia ruginei.

INDEPARTAREA PIETREI

Daca folositi detergentul in cantitatea recomandata, nu va fi nevoie sa indepartati piatra. Totusi, daca doriti sa aplicati procedura respectiva, folositi substante disponibile in comert si fiti atenti la atentionarile producatorilor.

⚠ ATENTIE!

Substantele pentru eliminarea pietrei contin acizi; acestia ar putea provoca modificarea culorii rufelor Dvs, dar si diverse efecte adverse asupra masinii de spalat.

SECTIUNEA 7:INFORMATII PRACTICE



Bauturi alcoolice: Portiunea patata trebuie intai spalata cu apa Rece, apoi stersa cu glicerina si apa si clatita cu o solutie de otet cu apa.



Crema de pantofi: Frecati usor pata, fara sa stricati materialul, apoi frecati cu detergent si clatiti. Daca nu dispare, frecati cu o solutie lcatuita din 1/3 alcool pur (96 de grade) si 2/3 apa, apoi clatit cu apa calduta.



Ceai si cafea: Intindeti suprafata patata deasupra unui vas/chiuvetei si turnati apa fierbinte (in limita temperaturii maxime suportate de materialul respectiv – vezi eticheta). Daca materialul suporta, spalati cu lesie.



Ciocolata si cacao: Inmuiati in apa rece, frecati cu sapun sau detergent, spalati la temperatura maxima pe care o suporta materialul respectiv. Daca pata nu iese, stergeti cu apa oxigenata (in proportie de 3%).



Sos de tomate: Frecati usor cu unghia petele uscate, fara sa stricati tesatura, apoi lasati in apa rece timp de cca 30 min si frecati cu detergent.



Ou: Indepartati resturile uscate de pe pata si stergeti cu un burete sau un material moale, umezit in apa rece. Frecati cu detergent si spalati cu lesie diluata.



Pete de grasime si ulei: Intai stergeti reziduurile. Frecati cu detergent si apoi spalati cu apa calduta si sapun.

MUSTARD

Mustar: Intai aplicati glicerina pe pata. Frecati cu detergent and apoi spalati. Daca pata persista, stergeti cu alcool (la rufe sintetice si colorate, o solutie de 1/3 alcool si 2/3 apa)



Pete de sange: Puneti rufa in apa rece 30 minute. Daca pata nu dispare, inmuiati intr-o solutie de apa si amoniac (3 linguri de amoniac in 4 litri de apa), timp de 30 minute.



Smantana, frisca, inghetata: Inmuiati rufa in apa rece si frecati portiunea patata cu detergent. Daca pata persista, aplicati lesie pe material. (Nu folositi lesie la rufe colorate)



Mucegai: Petele de mucegai trebuie indepartate cat mai Repede posibil. Pate se spala cu detergent, si daca nu dispare, trebuie stearsa cu apa oxigenata (in proportie de 3%).



Cerneala: Tineti suprafata patata sub jet de apa rece pana cand nu mai curge apa colorata. Apoi frecati cu apa, combinata cu suc de lamaie si detergent si spalati dupa 5 minute.



Fructe: Intindeti suprafata patata deasupra unui vas/chiuvetei si Turnati apa rece, in nici un caz apa fierbinte. Stergeti cu apa rece si aplicati glicerina. Asteptati cca 1-2 ore si clatiti dupa ce frecati cu cateva picaturi de otet.



Pete de iarba: Frecati pata cu detergent. Daca tesatura permite, folositi lesie. Frecati hainele de lana cu alcool. (Pentru rufe colorate, folositi o solutie din 1/3 alcool pur si 2/3 apa)



Vopsea: Pata trebui inlaturata inainte de a apuca sa se usuce, aplicand diluant pe ea. Apoi trebuie frecata cu detergent si spalata.



Pete de arsura: Daca tesatura permite utilizarea de lesie, adaugati lesie in apa de spalat. Pentru tesaturi din lana, rufele inmuiate in apa oxigenata trebuie acoperite in dreptul petei si se calca cu un material uscat deasupra. Trebuie spalat si clatit foarte bine.

SECTIUNEA 8: EVITAREA MICILOR ERORI

Orice reparatie de care are nevoie masina Dvs de spalat trebuie efectuata de catre personal calificat in acest sens. Cand este necesara o reparatie sau nu reusiti sa identificati cauza unei probleme aparute, procedati astfel:

- Scoateti masina din priza.
- Inchideti robinetul.
- Apelati la cel mai apropiat centru de service autorizat.

DEFECTIUNE	CAUZA PROBABILA	METODE DE REMEDIERE
Masina nu functioneaza.	Nu este conectata la priza.	Introduceti stecherul in priza.
	Siguranta e defecta.	Schimbati siguranta
	Nu aveti curent electric	Verificati daca aveti curent electric
	Nu ati apasat butonul Start/Pause	Apasati butonul Start/Pause.
	Butonul de programe este in pozitia O (off/ inchis).	Rotiti butonul de programe in dreptul programului dorit.
	Usa nu este bine inchisa.	Inchideti bine usa. Trebuie sa auziti un click.
Masina nu se alimenteaza cu apa.	Robinetul e inchis.	Deschideti robinetul
	Furtunul de alimentare e indoit.	Verificati furtunul
	Furtunul de alimentare este obstructionat.	Curatati filtrul. (*)
	Filtrul orificiului de intrare e blocat	Curatati filtrul. (*)
	Usa nu este bine inchisa	Inchideti bine usa. Trebuie sa auziti un click.
Masina nu evacueaza apa.	Furtunul de evacuare este indoit sau obstructionat	Verificati furtunul
	Filtrul pompei este blocat.	Curatati filtrul pompei. (*)
	Rufele din cuva nu sunt bine echilibrate	Distribuiti rufele din cuva in mod echilibrat.
Masina vibreaza.	Picioarele masinii nu sunt reglate corect.	Reglati picioarele. (**)
	Nu ati indepartat suruburile de la transport.	Indepartati suruburile de la transport.. (**)

(*) Vezi Sectiunea 6, referitoare la curatarea si intretinerea masinii de spalat.

(**) Vezi Sectiunea 2, referitoare la instalarea masinii de spalat.

DEFECTIUNE	CAUZA PROBABILA	METODE DE REMEDIERE
Masina vibreaza.	Cantitatea de rufe din cuva e prea mica.	Nu previne operarea masinii
	Cantitatea de rufe din cuva e prea mare sau rufele nu sunt distribuite in mod echilibrat.	Nu depasiti cantitatea maxima admisa si distribuiti rufele in mod echilibrat.
	Masina se atinge de un alt obiect.	Nu sprijiniti masina de un obiect dur.
Spuma excesiva in cuva.	Ati folosit prea mult detergent.	Apasati butonul Start/pause. Pentru a limita formarea de spuma, diluati o lingura de balsam in 0,5 litri de apa si turnati in sertarul de detergent. Apasati butonul Start/pause dupa 5-10 minute. Reglati cantitatea de detergent in mod corespunzator la urmatoarea spalare.
	Ati folosit un detergent inadecvat.	Folositi numai detergentii destinati utilizarii in masinile de spalat automate.
Nu obtineti rezultate satisfacatoare in urma spalarii.	Rufele sunt prea murdare pentru programul selectat de Dvs.	Selectati un program adecvat. (vezi Tabel-1)
	Cantitatea de detergent a fost insuficienta.	Folositi mai mult detergent, dar in conformitate cu recomandarile producatorului de detergent.

DEFECTIUNE	CAUZA PROBABILA	METODE DE REMEDIERE
Nu obtineti rezultate satisfacatoare in urma spalarii.	Ati depasit capacitatea maxima de incarcare cu rufe.	Nu depasiti capacitatea maxima.
	Gradul de duritate al apei este prea mare	Folositi detrgentul in cantitatea recomandata de producatorul acestuia.
	Rufele nu sunt bine distribuite in masina.	Imprastiati rufele in masina intr-o maniera echilibrata.
Apa este evacuata din masina imediat dupa alimentare.	Capatul furtunului de evacuare este prea jos fata de masina.	Asezati furtunul in pozitia corespunzatoare.(**)
Nu se vede apa in cuva in timpul utilizarii.	Nu este o defectiune. Apa se afla in partea inferioara a cuvei.	-
Exista urme de detergent pe rufe.	Unii detergenti contin particule mai mari care nu s-au dizolvat si s-au lipit pe rufe, sub forma unor pete albe.	Selectati programul de Clatire si mai clatiti o data, sau curatati rufele cu o perie, dupa ce se usuca.
Rufele prezinta pete gri	Aceste pete pot fi cauzate de ulei, frisca sau unguenti.	La urmatoarea spalare, utilizati cantitatea maxima de detergent recomandata de producatorul de detergent.

(**) Vezi Sectiunea 2, referitoare la instalarea masinii de spalat.

DEFECTIUNE	CAUZA PROBabila	METODE DE REMEDIERE
Procesul de stoarcere nu incepe sau incepe cu intarziere.	Nu este o defectiune. Acest lucru se datoreaza probabil controlului echilibrarii incarcaturii de rufe din masina.	Sistemul de control al incarcaturii cu rufe va incerca sa distribuie rufele din cuva intr-o maniera omogena. Dupa aceasta, va incepe si procesul de stoarcere. La urmatoarea spalare, asezati rufele in cuva intr-o maniera mai echilibrata.

SECTIUNEA 9: SISTEMUL DE DETECTARE AUTOMATA A ERORILOR

Masina Dvs este echipata cu sisteme de control permanent al proceselor de spalare; aceste sisteme vor lua masurile de precautie necesare impotriva erorilor, dar va si anunta asupra aparitiei acestora.





COD EROARE	INDICATOR EROARE	POSIBILA CAUZA	METODA DE REMEDIERE
Err 01	Indicatorul Start/Pause lumineaza intermitent.	Usa nu este bine inchisa.	Inchideti corect usa, in asa fel incat sa auziti un click. Daca problema persista, opriti masina, scoateti din priza si apelati imediat la un centru de service autorizat.





COD EROARE	INDICATOR EROARE	POSIBILA CAUZA	METODA DE REMEDIERE
Err 02	Indicatorul Setare program lumineaza intermitent.	Nivelul apei din masina se afla sub dispozitivul de incalzire. E posibil ca presiunea sursei de alimentare sa fie scazuta sau fluxul de apa sa fie blocat.	Deschideti complet robinetul de apa. Verificati daca apa nu este cumva oprita. Daca problema persista, masina se va opri in mod automat dupa un timp. Scoateti din priza, inchideti robinetul si aelati la un centru de service autorizat.
Err 03	Indicatoarele Start/pause si Setare program lumineaza intermitent.	Pompa s-a defectat sau filtrul de la pompa este obstructionat.	Curatati filtrul de la pompa. Daca problema persista, apelati la un centru de service autorizat. (*)
Err 04	Indicatorul Terminare program lumineaza intermitent.	Eroare de comunicare	Opriti masina si scoateti din priza. Inchideti robinetul si apelati la un centru de service autorizat.





(*) Vezi Sectiunea 6, referitoare la curatarea si intretinerea masinii de spalat.



COD EROARE	INDICATOR EROARE	POSIBILA CAUZA	METODA DE REMEDIERE
Err 05	Indicatoarele Start/Pause si Terminare program lumineaza intermitent.	Dispozitivul de incalzire a apei sau senzorul de caldura s-a defectat.	Opriti masina si scoateti din priza. Inchideti robinetul si apelati la un centru de service autorizat.
Err 06	Indicatoarele Setare program si Terminare program lumineaza intermitent.	Defectiune la motor	Opriti masina si scoateti din priza. Inchideti robinetul si apelati la un centru de service autorizat.
Err 07	Indicatoarele Start/Pause, Setare program Si Terminare program sunt aprinse in permanenta	Eroare de configurare.	Opriti masina si scoateti din priza. Inchideti robinetul si apelati la un centru de service autorizat.
Err 08	Indicatoarele Start/pause, Setare program si Terminare program lumineaza intermitent.	Eroare de sistem	Opriti masina si scoateti din priza. Inchideti robinetul si apelati la un centru de service autorizat.
Err 09	Indicatoarele Setare program si Terminare program sunt aprinse in permanenta.	Voltajul retelei electrice e prea scazut sau prea ridicat.	Daca voltajul retelei electrice este mai mic de 150V sau mai mare de 260V, masina de spalat se va opri automat. Cand voltajul normal este restabilit, masina isi va continua programul.

SECTIUNEA 10: SIMBOLURI INTERNATIONALE PENTRU SPALARE

			
Temperatura de spalare.	NU spalati (spalare manuala)	Temperatura redusa la calcat.	Temperatura medie la calcat.

			
Temperatura ridicata la calcat.	Nu calcati.	Nu stoarceti.	Atarnati pentru uscare.

			
Lasati la scurs.	Uscati intins.	Fara inalbitor.	Folositi inalbitor.

		
<p>Acestea sunt simboluri pentru moduri de curatare chimica a rufelor. Literele reprezinta instructiuni despre tipul agentului de curatare care trebuie folosit. Hainele care au aceste simboluri pe eticheta nu trebuie spalate la masina, decat daca exista si simboluri care permit acest lucru.</p>		

THE CONTENTS

SECTION 1:BEFORE USING

- Safety warnings
- Recommendations

SECTION 2:INSTALLATION

- Removal of transportation screws
- Adjustment of feet
- Electrical connection
- Water supply connection
- Water drain connection

SECTION 3:TECHNICAL SPECIFICATIONS

SECTION 4:CONTROL PANEL

- Start/Pause button
- Function indicator lights
- Function buttons
- Temperature knob
- Program knob

SECTION 5:WASHING YOUR LAUNDRY

- Before washing
- Running the machine

SECTION 6:MAINTENANCE AND CLEANING

- Water inlet filters
- Pump filter
- Detergent drawer
- Siphon plug
- The cabinet
- The drum
- Remove of your machine from lime

SECTION 7: PRACTICAL INFORMATION

SECTION 8:AVOIDING MINOR FAULTS

SECTION 9:AUTOMATIC FAILURE DETECTION SYSTEM

SECTION 10:INTERNATIONAL WASHING SIGNS

SECTION 1:BEFORE USING SAFETY WARNINGS

- Do not use a multiple socket or extension cord.
- Do not insert a plug with damaged or broken cord into the socket.
- If the cord is damaged it should be replaced by the manufacturer or appointed service agent in order to avoid a hazard.
- Never remove the plug from the socket by pulling from the cord section. Remove the plug by holding.
- Do not plug the power supply with wet hands.
- Never touch the machine with wet hands or feet.
- Never open the detergent drawer while the device is running.
- Never force to open the door of the machine while the machine is running.
- Since the machine can reach high temperatures while running, do not touch the drain hose and water during draining.
- In case of any failure, first unplug the device and close the water tap. Do not attempt to repair. Please apply to the nearest authorized service station.
- Do not forget that the packing material of your machine may be hazardous for children.
- Do not let your children play with the washing machine.
- Keep your pet away from your machine.
- Your machine should only be used by adults within the information written in this manual.
- Your machine is designed for use in house environment. Warranty will be invalid if you use it for commercial purposes.
- The appliance should not be put on a carpet which can block the air ventilation on the bottom side.

RECOMMENDATIONS

- The detergent or softener in contact with air for a long time will dry and stick to your detergent drawer. To avoid this put your detergent and softener into the detergent drawer just before washing.
- It is recommended that you use pre-washing program for only very dirty clothes.
- Please do not exceed the maximum loading capacity.
- The appliance is not intended for use by people (including children) with reduced physical, sensor or mental capabilities, or lack of experience and knowledge, unless they have been given supervision or instruction concerning use of the appliance by a person responsible for their safety. Children should be supervised to ensure that they don't play with the appliance.

- If you will not use your machine for a long time, unplug your machine, close the water supply and leave the door open in order to keep the inside of the machine dry and for prevention from unpleasant odour.
- As a result of the quality control procedures, a certain amount of water may remain in your machine. This is not harmful for your machine.

SECTION 2: INSTALLATION

You must pay attention to the following issues before using your washing machine.

REMOVAL OF TRANSPORTATION SCREWS

- Transportation screws, which are located at the back side of the machine, must be removed before running the machine.
- Loosen the screws by rotating counterclockwise by a suitable wrench. (DIAGRAM-1)
- Remove the screws by pulling them. (DIAGRAM-2)
- To the holes where the transport screws have been removed, insert the plastic transport screw taps found in the accessories bag. (DIAGRAM-3)
- The transportation screws, that have been removed from the machine should be kept in hand for any other transportation necessities.



DIAGRAM-1

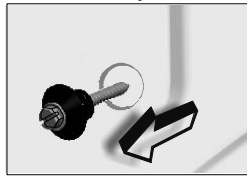

DIAGRAM-2

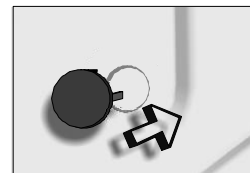
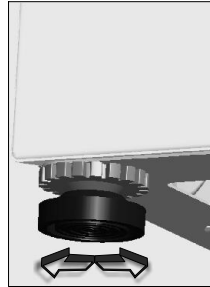
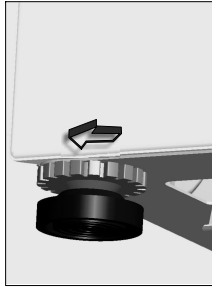

DIAGRAM-3

ADJUSTMENT OF FEET

- Do not install your machine on rugs or similar surfaces.
- For your machine to work silently and without any vibration, it should be settled on a flat, non-slippery and tough ground.

- You can adjust the balance of your machine from its feet.
- First, loosen the plastic adjustment nut.
- Adjust by rotating the feet upwards or downwards.
- After the balance has been reached, tighten the plastic adjustment nut again by rotating it upwards.
- Never put cartons, wooden blocks or similar materials under the machine to balance the irregularities on the level of the ground.



ELECTRICAL CONNECTION

- Your washing machine works with 220-240V and 50Hz.
- A special grounded plug has been attached to the network cable of your washing machine. This plug must definitely be inserted to a grounded socket with 10 ampere. The fuse flow value of the electricity line attached to this should also be 10 ampere. If you have no such sockets and fuses in your house, let it be made by a qualified electrician.
- **Our company will not be responsible for any damages that may occur as a result of usage without grounding.**

WATER SUPPLY CONNECTION

- Your machine has a single water (cold) inlet.
- To prevent from the leakages on the connection joints, 1 seal is included in the hose packing.(Fit this seal on the end of the water inlet hose at the tap side.)
- Connect the end with bracket of the water inlet hose to the water inlet valve at the rear of the machine and the other end to your tap. In situations where you are not assured, let a qualified plumber make the connection works.
- Water pressure of 0,1-1 MPa from your tap will enable your machine to work more efficiently.(0,1 MPa pressure means water flow of more than 8 liters in 1 minute from a fully opened tap)
- After connections are completed, check for the non-leakage of the connection joints by turning on your tap completely.
- Be sure that water inlet hoses are not folded, broken or crushed.
- Mount the water inlet hoses to a 3"/4, geared water tap.

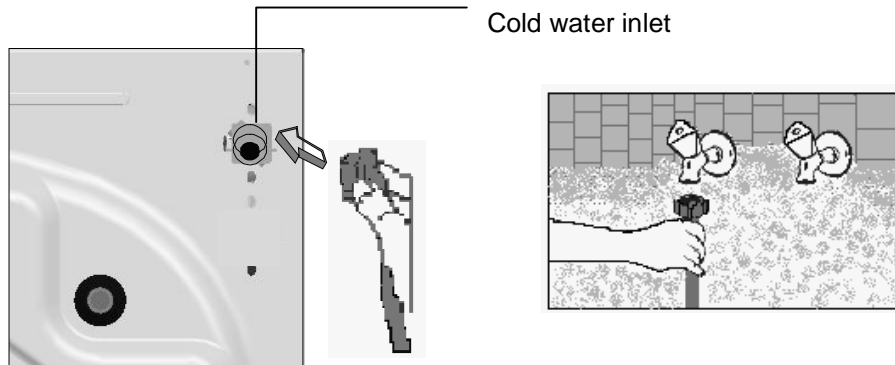

WATER DRAIN CONNECTION

- Be sure that water inlet hoses are not folded, twisted, crushed or elongated by stretching.
- Water drain hose should be mounted at a height of minimum 60 cm, maximum 100 cm from the ground.
- The end of the water drain hose may directly be fitted to the dirty water outlet hole or a special apparatus mounted on the outlet bracket of the wash-stand.
- Never attempt to extend the water drain hose by adding extra parts.

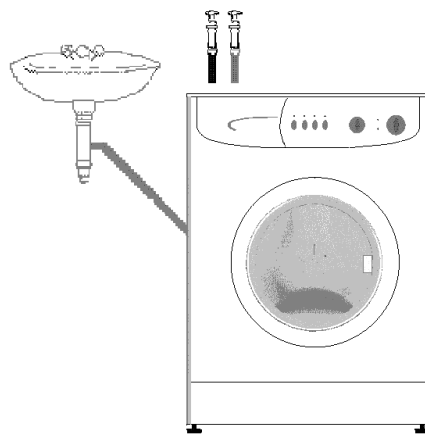

SECTION 3: TECHNICAL SPECIFICATIONS

	442/542/ 642/842/1042
Maximum dry laundry capacity (kg)	5
Recommended loading (kg)	4,5
Height (cm)	85
Width (cm)	59,6
Depth (cm)	51
Maximum spin cycle (rpm)	400/500/ 600/800/1000

(*) Maximum spin cycles depend on the model you've chosen

SECTION 4:CONTROL PANEL

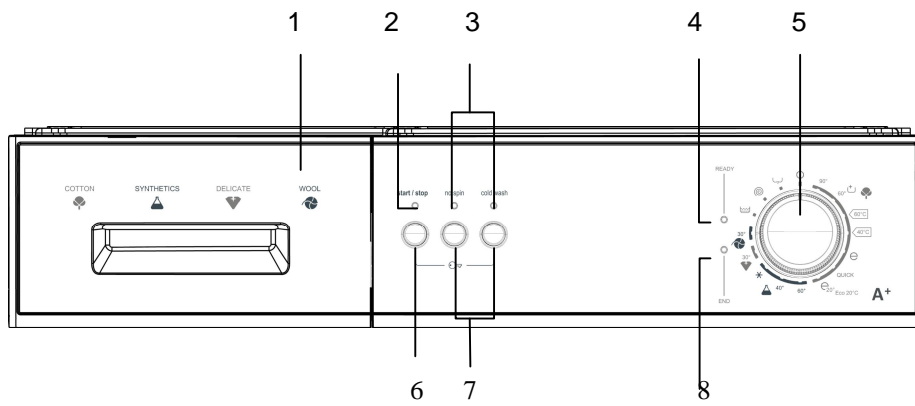

1-Detergent drawer
 2-Start/pause light
 3-Function indicator lights
 4-Program ready light

5-Program knob
 6-Start/pause button
 7-Function buttons
 8-Program end light

START/PAUSE BUTTON

start / stop Used to start a selected program or pause during running.

WARNING!

It is required for the program knob to be brought to O(off) position before selecting the program or changing a continuing program.

FUNCTION INDICATOR LIGHTS



When the start/pause button or any function button is pressed, the corresponding light turns on. The light turns off when the function button or start/pause button is re-pressed, or when the process the selected function is completed.

The function indicator lights are also used in failure detection system mentioned in section 9.

FUNCTION BUTTONS

no spin **No spin**

This program is recommended to be used for your sensitive clothes on which no spinning should be done. By pressing this function button, you can cancel the spinning process which is included in the program.

cold wash **Cold wash**



When this button is pressed, your clothes are washed with cold water. With this function, you can wash your slightly dirty clothes using less energy and water.

⚠ WARNING!

Functions vary depending on the model you have chosen. If you forgot to use additional function and your machine starts to wash, push the additional function button if the indicator light is on. Additional function will be activated. If the indicator light is not on, additional function will not be activated.

PROGRAM KNOB

With the program knob, you can select the program with which you desire to wash your clothes. You can adjust the program selection process by turning the program knob in both directions. You must be careful that the adjustment sign of the program knob is exactly on the program you want to select. When you bring the program knob to O(off) position, while your machine is running, your program will remain incomplete.

Cotton 90°C
Cotton 60°C with prewash
Cotton 60°C 
Cotton 40°C 
Eco wash
Quick wash
Eco 20°
Synthetic 60°C
Synthetic 40°C
Synthetic cold
Delicate 30°C
Wool 30°C
Rinsing
Spin
Draining
OFF

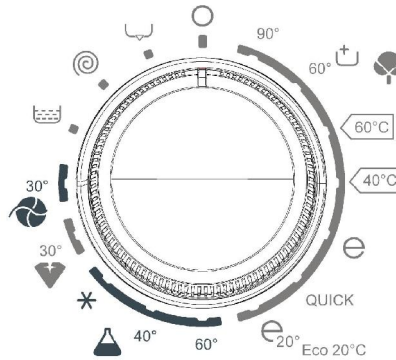

SECTION 5: WASHING YOUR LAUNDRY

- Plug the machine.
- Open the tap water.

First wash cycle

There may be water left inside your machine after factory tests and trials. It is recommended that the first wash cycle should be made without any laundry so that carry out this water; pour half a measuring cup of normal allpurpose detergent into compartment 2 and select cotton program at 90°C.

BEFORE WASHING

Discrimination of your laundry

- Discriminate your clothes according to their types (cotton, synthetic, sensitive, woolen, etc.), washing temperatures and level of dirtiness.
- Never wash your white and coloured clothes together.
- Since your new coloured clothes may shed dye on the first wash, wash them separately.
- Be careful that no metal pieces are found on or in the pockets of your clothes, remove if there is any.
- Zip and button your clothes.
- Remove the plastic or metal hooks of the curtains and laces or place them inside a washing bag and tie.

- Pull the textiles like trousers, knitted fabric, t-shirt and sweat shirt inside out.
- Wash your small clothes like socks and handkerchiefs in a washing bag.



Wash up to 90 °C Wash up to 60 °C Wash up to 30 °C Not washable in washing machine

Placement of the clothes into the machine

- Open the door of your machine.
- Fill your clothes in your machine in a well-spread manner.
- Place each cloth separately.
- When you shut the door of your machine, be careful that no cloth is jammed between the cover and the gasket.
- Shut the door of your machine tightly otherwise your machine will not start the washing process.

Filling detergent in the machine

The quantity of the detergent that you will fill in your machine depends on the following criteria:

- Your detergent consumption will change according to the dirtiness level of your clothes. For your slightly dirty clothes, do not pre-wash and put a small amount of detergent in the compartment no.2 of the detergent drawer.
- For your excessively dirty clothes, select a program with pre-washing, fill ¼ portion of the detergent you will put in compartment 1 in the detergent drawer and the remaining portion in compartment 2.
- In your machine, use the detergents developed especially for automatic washing machines. The quantities that will be used for your clothes are written on the packing of the detergents.
- As the hardness of your water increases, the amount of the detergent to be consumed will also increase.
- As the amount of your clothes increases, the amount of the detergent to be consumed will also increase.
- Fill your softener in the softener compartment in your detergent drawer. Do not exceed the MAX level. Otherwise, the softener will diffuse in the washing water via the siphon.
- The softeners with high density should be diluted with some water before filling in the drawer. That is because the softener with high density obstructs the siphon and prevents the flow of the softener.

- You can use fluid detergents in all programs without pre-washing. For this, mount the fluid detergent level plate in the second compartment of the detergent drawer and arrange the amount of fluid detergent according to the levels on this plate.

RUNNING THE MACHINE

Program selection and features

Select the program and additional functions appropriate for your clothes from Table-1.

Just for the first run please choose a program and press Start/pause button for 4 seconds, before putting your load in. This is necessary for unloading the water that is left after the production and tests.

Start/Pause

By pressing this button, you can start the program you have selected or pause a running program.

Starting the program

- Adjust the program knob to a program you desire.
- The program ready light will be on.
- If you want, you can select one or more additional functions.
- Run the program which you have selected by pressing the Start/Pause button.

Changing the program

If you have selected a program and you do not want it to continue:

- Press the start/pause button.
- Bring the program knob to O(off) status.
- Adjust the program knob to the program you desire. (You can select the program that you desire from Table-1).
- The program ready light will be on.
- By pressing the start/pause button, run the program which you have selected.

Cancellation of the Program

If you desire to end a running program early:

- Press the start/pause button.
- Turn the program knob to O(off) status.
- Turn the program knob to "Draining" or "Spinning" programs.
- The program ready light will be on.
- Run the program you have selected by pressing the start/pause button.

Program ending

- Your machine will automatically stop when the program you have selected ends.

- The door will be unlocked in approximately two minutes after the program ends. You can open the door by pulling the handle of the door towards yourself and take out your clothes.
- After you unload your clothes leave the door open to dry the interior of your machine.
- Unplug your machine.
- Close the water tap.

⚠ WARNING!

If the power is off and on again after a while on any stage of the washing program, your machine will continue the program from the point where it was interrupted. This is not harmful for your machine.

Child lock

Child lock is used in order to protect the washing cycle from the effects of unwanted button activations during the cycle. Child lock is activated by pressing the first and third button on the control panel at the same time for more than 3 sec. When child lock is activated, LEDs on the function buttons blink to indicate that child lock is active. In order to deactivate child lock, the same buttons (1st and 3rd) should be pressed again for more than 3 seconds. Deactivation of child lock is shown by blinking of LED on Start/Pause button.

SECTION 6: MAINTENANCE AND CLEANING

- Unplug your machine.
- Close the water tap.

WATER INLET FILTERS

On the tap part of your machine's water inlet hose and at the ends of water inlet valves, there are filters to prevent entrance of the dirt and foreign materials in the water to the machine. If the machine is unable to receive sufficient water although your water tap is opened, these filters should be cleaned.



PROGRAM	DETERGENT COMPART.	MAX DRY LOAD CAPACITY (kg)	TYPE OF LAUNDRY	EXPLANATIONS
		442/ 542/ 642/842/1042		
COTTON 90°	2	5	Dirty, boil, cotton and linen textile	Underwears, sheet, table cloth, t-shirt, shirt, towel (max.2,5 kg)
COTTON 60° (PREWASH)	1+2	5	Very dirty, cotton, coloured and linen textile	
COTTON 60° 	2	5	Dirty, cotton, coloured and linen textile	
COTTON 40° 	2	5	Dirty, cotton, coloured and linen textile	
ECO WASH	2	5	Dirty, cotton, coloured and linen textile	
QUICK WASH	2	2,5	Slightly dirty, cotton, coloured and linen textile	
ECO 20°	2	2,5	Slightly dirty cotton, coloured and linen textile. Washed without heating the tap water.	
SYNTHETIC 60°	2	3	Dirty, synthetic or synthetic mixture textile	Nylon socks, blouse
SYNTHETIC 40°	2	3	Slightly dirty, synthetic or synthetic mixture textile	Nylon socks, blouse
SYNTHETIC COLD	2	3	Slightly dirty, synthetic or synthetic mixture sensitive laundry. Washed without heating the tap water.	Nylon socks, blouse
DELICATE 30°	2	2	Slightly dirty, cotton, coloured, synthetic or synthetic mixture sensitive laundry	Silk mixture, shirt, blouse, polyester, poliamid, mixture textile
WOOL 30°	2	2	Dirty, hand and machine to wash wool laundry	All wool laundry

TABLE-1

PROGRAM	DETERGENT COMPART.	ADDITIONAL FUNCTION BUTTON	MAX DRY LOAD CAPACITY (kg)	TYPE OF LAUNDRY	EXPLANATIONS
			442/542/642/842/1042		
RINSING					When you need an additional rinsing to be done to your clothes after the washing process, you can use this program for all kinds of clothes.
SPINNING					When you need an additional spinning to be done to your clothes after the washing process, you can use this program for all kinds of clothes.
DRAINING					This program is used to drain the dirty water inside after the washing process of your machine. If you want the water inside your machine to be drained before the program ends, you can use this program.

TABLE-1 CONTINUE

(*) You can use softeners in all programs (except spinning and draining programs) optionally. When you arrange the quantity of the softener, comply with the warning of the softener producer. Fill your softener in its  (softener) compartment of the detergent drawer.

Program duration, energy consumption and water consumption values may vary according to wash load weight and type, selected extra functions, tap water and ambient temperature.

- Remove the water inlet hose.
- Remove the filters found on the water inlet valves by using a pincer and wash thoroughly with a brush.
- Clean the filters of the water inlet hoses located on the tap side by removing manually together with the seal.
- After you clean the filters, you can fit them the same way as you have removed.

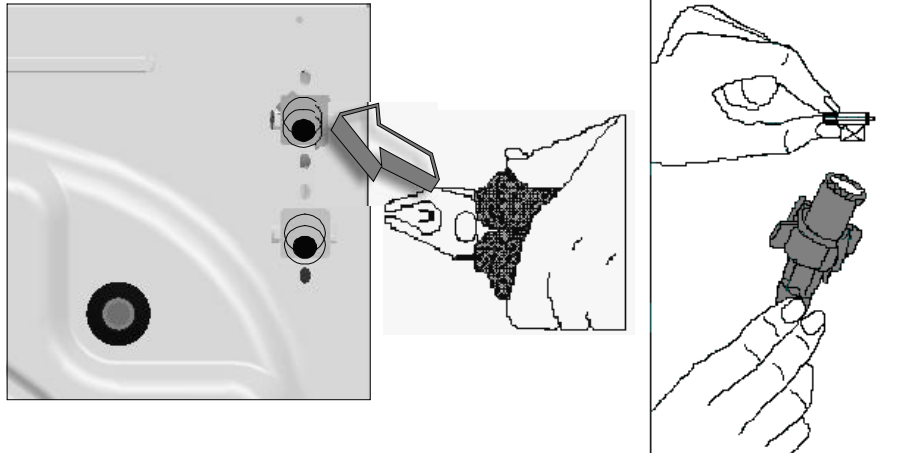

PUMP FILTER

The pump filter system elongates the life of your pump, which is used to drain the dirty water. It prevents lint to enter the pump. Cleaning of your pump filter in every 2-3 months is recommended. To clean your pump filter:

- Open the kickplate's cover, by pulling the handle.
- Before opening the filter cover, place a cup in front of the filter cover to prevent flow of the remaining water in the machine.
- Loosen the filter cover by rotating it counter clockwise and drain the water.
- Remove the foreign materials from the filter.
- Check for the rotation of the pump manually.
- After you have cleaned the pump, fit the filter cover by rotating clockwise.
- Put the kickplate cover into the place.
- Do not forget that if you do not fit in the filter cover properly, it will leak water.

⚠ WARNING!

Danger of being scalded!

Since the water inside the pump may be hot, wait for it to cool.

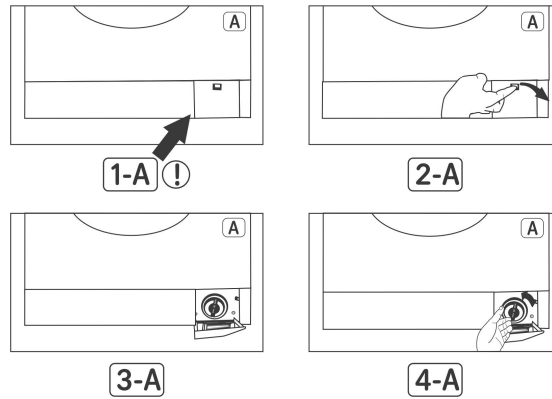

DETERGENT DRAWER

Detergents may form a sediment in your detergent drawer or in housing of the detergent drawer in time. To clean the sediment, pull out the detergent drawer from time to time. To pull out the detergent drawer:

- Pull the detergent drawer to the end. (DIAGRAM-1)
- Lift the front of the drawer, continue to pull until the drawer is pulled out. (DIAGRAM-2)
- Wash with an old toothbrush and excessive amount of water.
- Take off the leftover detergent avoid to drop into your machine.
- After drying the detergent drawer put into the housing in the same manner you pull out.

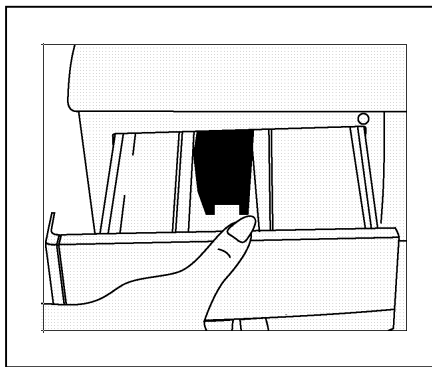

DIAGRAM-1

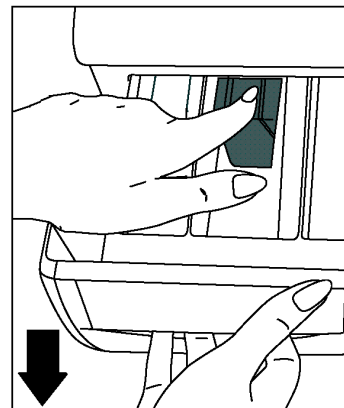
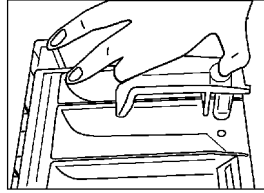

DIAGRAM-2

SIPHON PLUG

Pull out the detergent drawer. Remove the siphon plug and clean the residues of the softener thoroughly. Fit the cleaned siphon plug in its location. Check if it placed properly.



THE CABINET

Clean the exterior surface of the cabinet of your machine with lukewarm water and a cleaning substance that will not irritate the cabinet. After rinsing with clean water, wipe it with a soft and dry cloth.

⚠ WARNING!

If the machine is installed in a location where the ambient temperature can fall below 0 °C, do the following when it will not be in use:

- Plug in the machine.
- Close the water tap and pull out the water inlet hose or hoses from the tap.
- Place the ends of the water drain and water inlet hoses in a cup on the ground.
- Adjust the program knob to "Draining" program.
- The program ready light will be on.
- Run the program by pressing the start/pause button.
- Unplug your machine when the program is over (program end light is on).

When you complete these proces, the remaining water inside the machine will be drained and thus formation of ice in the machine will be prevented. When you operate your machine again, be sure that the ambient temperature is above 0 °C.

THE DRUM

Do not leave metal parts like needles, staples or coins inside your machine. These pieces cause formation of rust stains in the drum. To eliminate these stains of rust, use a cleaning substance without chlorium and follow the warnings of the cleaning substance producer. For cleaning of the rust stains, never use dish-washing wires or similar rough objects.

REMOVE OF LIME FROM YOUR MACHINE

If you arrange the amount of the detergent you use in your machine properly, there will be no need for lime removal. However, if you desire to apply the removal procedure, use the lime protectors in the market and pay attention to their warnings.

⚠ WARNING!

The lime eliminating substances contain acids and this may cause colour modifications in your clothes along with an adverse effect on your machine.

SECTION 7:PRACTICAL INFORMATION



Alcoholic beverages: The stain point, should first be washed with cold water, than should be wiped with glycerine and water and be rinsed with water mixed with vinegar.



Shoe Polish: The stain should be slightly scratched without ruining the cloth, rubbed with detergent and rinsed. In case it is not eliminated, it should be rubbed with 1 unit of pure alcohol (96 degrees) mixed in 2 units of water and then washed with lukewarm water.



Tea and coffee: Stretch the stained area of your cloth on the top of a container and pour water as hot as the type of your cloth can endure on it. If the type of your cloth is suitable, wash it with lye.



Chocolate and cocoa: By leaving your clothes in cold water and rubbing with soap or detergent, wash it in the highest temperature that the type of your cloth can endure. If there is still a stain of oil left, wipe with oxygenated water (in proportion of 3%).



Tomato paste:After scraping the dried pieces without ruining the cloth, leave in cold water for about 30 minutes and wash by rubbing with detergent.



Meat broth-egg: Eliminate the dried stain residues and wipe with a sponge or soft cloth wetted in cold water. Rub with detergent and wash with diluted lye.



Grease and oil stains: First wipe the residues. Rub the stain with detergent and then wash with lukewarm soapy water.

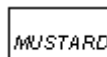

MUSTARD

Mustard: First apply glycerine to the stained area. Rub with detergent and then wash. If the stain still does not disappear, wipe with alcohol (On synthetic and coloured cloth, a mixture of 1 unit alcohol, 2 units water should be used)



Blood stain: Lay your clothes in cold water for 30 minutes. If the stain still does not disappear, lay in mixture of water and ammonia (3 table-spoons of ammonia in 4 liters of water)for 30 minutes.



Cream, ice-cream and milk: Lay your clothes in cold water and rub the stained area with detergent. If the stain has still not disappeared, apply lye on the fabric of your clothes in proper proportion.(Do not use lye on coloured clothes.)



Mould: Mould stains should be cleaned as soon as possible. The stain should be washed with detergent, and if it does not disappear, it should be wiped with oxygenated water (in proportion of 3%).



Ink: Hold the stained area under cold water and wait until the inky water completely runs off. Then rub with water diluted with lemon juice and detergent, wash after waiting for 5 minutes.



Fruit: Stretch the stained area of your clothes on the top of a container and pour cold water on it. Do not pour hot water on the stain. Wipe with cold water and apply glycerine. Wait for 1-2 hours and rinse after wiping with a few drops of white vinegar.



Grass stain: Rub the stained part with detergent. If the type of fabric is suitable for use of lye, wash it with lye. Rub your woolen clothes with alcohol. (For coloured ones, a mixture of 1 unit pure alcohol and 2 units of water).



Oil Paint: The stain should be eliminated before it dries by applying thinner on it. Then it should be rubbed with detergent and washed.



Burnt stain: If your cloth is suitable for use of lye, you can add lye into your washing water. For woolen fabric, a cloth damped in oxygenated water should be covered on the stain and it should be ironed with a dry cloth on it. It should be washed after rinsing well.

SECTION 8: AVOIDING MINOR FAULTS

All repairing which must be done on the machine should be done by authorized service. When a repairing is required for your machine or you are unable to eliminate the failure with the help of the information given below:

- Unplug the machine.
- Close the water tap.
- Apply to the nearest authorized service station.

FAILURE	PROBABLE CAUSE	METHODS OF ELIMINATION
Your machine does not operate.	It is unplugged.	Insert the plug into the socket.
	Your fuse is defected.	Change your fuse.
	The electric power is off.	Check the electric power.
	Start/pause button has not been pressed.	Press the start/pause button.
	The program knob is in O(off) status.	Bring the program knob on the desired status.
	The door is not shut properly.	Shut the door properly. You should hear the click.
Your machine does not receive water.	Water tap is closed.	Open water tap.
	The water inlet hose may be bent.	Check the water inlet hose.
	The water inlet hose is obstructed.	Clean the filters of water inlet hose. (*)
	The valve inlet filter is obstructed.	Clean the valve inlet filters. (*)
	The door is not shut properly.	Shut the door properly. You should hear the click.
Your machine is not draining water.	The drain hose is obstructed or bent.	Check the drain hose.
	The pump filter is obstructed.	Clean the pump filter. (*)
	The clothes are not placed inside the machine in a well-balanced manner.	Spread the clothes inside the machine in an orderly and well-balanced manner.
Your machine is vibrating.	The feet of your machine are not adjusted.	Adjust the feet. (**)
	Transportation screws are not removed.	Remove transportation screws. (**)

(*)See the section concerning the maintenance and cleaning of your machine.

(**)See the section concerning installations your machine.

FAILURE	PROBABLE CAUSE	METHODS OF ELIMINATION
Your machine is vibrating.	There is a small amount of clothes in the device.	It does not prevent operation of the machine.
	Excessive amount of clothes are filled in the machine or the clothes are not placed in a well-balanced manner.	Do not exceed the recommended quantity of clothes and spread your clothes in the machine in a well-balanced manner.
	Your machine touches a rigid object.	Prevent your machine's leaning on a tough place .
Excessive foam in the detergent drawer.	Too much detergent has been used.	Press the start/pause button. In order to stop the foam, dilute one table-spoon of softener in half liter of water and pour it in the detergent drawer. Press the start/pause button after 5-10 minutes. Arrange the amount of the detergent properly in the next washing process.
	Wrong detergent has been used.	Use only the detergents produced for full automatic machines.
The washing result is bad.	Your laundry too dirty for the program you have selected.	Select a suitable program. (see Table-1)
	The amount of detergent used is not sufficient.	Use more detergent according to the detergent.

FAILURE	PROBABLE CAUSE	METHODS OF ELIMINATION
The washing result is not good.	Clothes exceeding the maximum capacity has been filled in your machine.	Put the clothes in your machine in a manner not to exceed its maximum capacity.
	Your water may be hard.	Use the amount of detergent according to the declaration of the detergent producer.
	Distribution of the clothes in your machine is not well-balanced.	Spread the clothes inside the machine in an orderly and well-balanced manner .
The water is drained from the machine as soon as it is filled.	The end of the water drain hose is in a position too low according to the machine.	Place the water drain hose in an appropriate height.(**)
No water is seen in the drum during washing.	No failure. The water is at the lower part of the drum.	-
There are residues of detergent on the clothes.	The pieces of some detergents which do not dissolve in water may stick to your clothes as white stains.	By calibrating your machine for "Rinsing" program,make an additional rinsing or eliminate the stains After drying with the help of a brush.
There are gray stains on the clothes.	These stains may be caused by oil,cream or ointment .	In the next washing operation, use the maximum detergent amount declared by the detergent producer.

(**) See the section concerning instalations your machine.

FAILURE	PROBABLE CAUSE	METHODS OF ELIMINATION
The spinning process is not done or starts with delay .	No failure. The unbalanced load control may works in that way.	The unbalanced load control system will try to distribute your clothes in a homogenous manner. After your clothes are distributed, passage to spinning process will be realized. In the next washing process, place your clothes into the machine in a well-balanced manner.

SECTION 9: AUTOMATIC FAILURE DETECTION SYSTEM

Your machine is equipped with systems which will both take the necessary precautions and warn you in case of any failure by controlling it self constantly during the washing processes.





FAILURE CODE	FAILURE INDICATOR	PROBABLE FAILURE	THE PROCESS TO BE DONE
Err 01	The start/pause light blinks.	The door is not shut properly.	Shut the door properly so that you hear the click. If the problem persists, turn off the machine unplug and apply to the nearest authorized service immediately.





FAILURE CODE	FAILURE INDICATOR	PROBABLE FAILURE	THE PROCESS TO BE DONE
Err 02	The program ready light blinks.	The water level in your machine is below heater. The pressure of your water supply may be low or locking.	Turn on the tap to the end. Water may be cut, check it. If the problem is still continuing, your machine will automatically stop after a while. Unplug your machine, turn off the tap and apply to the nearest authorized service.
Err 03	The start/pause light and program ready light blinks .	The pump has failed or the pump filter is obstructed.	Clean the pump filter. If the problem persists, apply to the nearest authorized service. (*)
Err 04	The program end light blinks .	Communication error	Shut down your machine and unplug. Turn off your tap and apply to the nearest authorized service.





(*) See the section regarding the maintenance and cleaning of your machine.



FAILURE CODE	FAILURE INDICATOR	PROBABLE FAILURE	THE PROCESS TO BE DONE
Err 05	The start/pause light and program end light blink.	The heater of your machine or the heat sensor has failed.	Shut down your machine and unplug. Turn off your tap and apply to the nearest authorized service.
Err 06	The program ready light and program end light blink.	The motor has failed.	Shut down your machine and unplug. Turn off the tap and apply to the nearest authorized service.
Err 07	The program start/pause light, ready light and program end light stays on permanently.	Configuration error.	Shut down your machine and unplug. Turn off the tap and apply to the nearest authorized service.
Err 08	The start/pause light, program ready light and program end light blink.	Fault error	Shut down your machine and unplug. Turn off the tap and apply to the nearest authorized service.
Err 09	The program ready light and program end light stays on permanently.	The network voltage is too high or too low.	If the network voltage is lower than 150V or higher than 260V, your machine will automatically stop. When the network voltage is recovered, your machine will continue its operation.

SECTION 10: INTERNATIONAL WASHING SIGNS

			
Washing temperature.	Do not wash (hand wash)	Lukewarm iron.	Medium hot iron.

			
Hot iron.	Do not iron.	Do not tumble dry.	Hang to dry.

			
Drip dry.	Dry flat.	Do not bleach.	Handy to bleach.

		
<p>All of these are dry cleaning symbols. The letters are to instruct the cleaner what type of solvent to be used. Garments bearing these symbols should not be washed in your machine unless the label says otherwise.</p>		

52127577