

Haier

CABINET TYPE AIR CONDITIONER OPERATION MANUAL AND INSTALLATION MANUAL

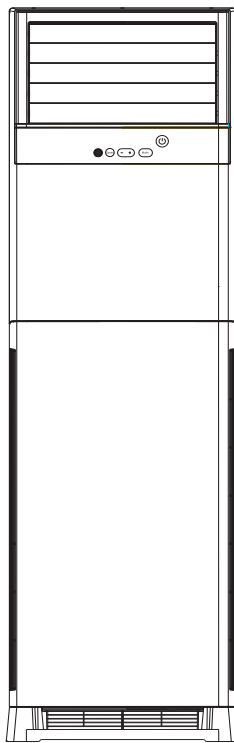

AP48KS1ERA
AP60KS1ERA



AP48DS1ERA

English

Español

Italiano

Français

Deutsch

- Please read this manual carefully before installation.
Keep this operation manual for future reference.

0150508963 C

CABINET TYPE AIR CONDITIONER OPERATION MANUAL AND INSTALLATION MANUAL

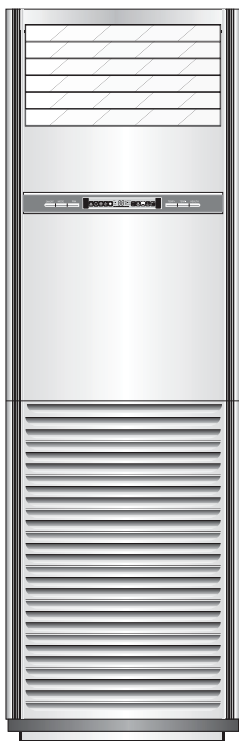

AP48KS1ERA
AP60KS1ERA

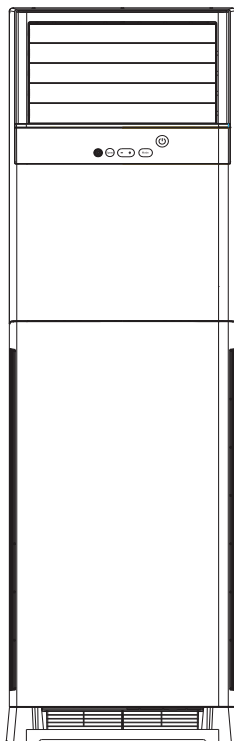

AP48DS1ERA

Contents

Cautions	3
Parts and Functions	5
Operation	7
Energy Saving	9
Maintenance	10
Troubleshooting	11
Indoor & Outdoor Unit Connection	14
Installation Procedure	15

English

- Please read this manual carefully before installation.
Keep this operation manual for future reference.

EUROPEAN REGULATIONS CONFORMITY FOR THE MODELS

CE

All the products are in conformity with the following European provision:

- Low Voltage Directive 73/23/EEC
- Low Voltage Directive 2006/95/EC
- Electromagnetic Compatibility 89/336/EEC
- Electromagnetic Compatibility 2004/108/EC

ROHS

The products are fulfilled with the requirements in the directive 2002/95/EEC of the European parliament and of council on the Restriction of the use of Certain Hazardous Substances in Electrical and Electronic Equipment (EU RoHS Directive)

WEEE

In accordance with the directive 2002/96/CE of the European parliament, herewith we inform the consumer about the disposal requirements of the electrical and electronic products.

DISPOSAL REQUIREMENTS:



Your air conditioning product is marked with this symbol. This means that electrical and electronic products shall not be mixed with unsorted household waste. Do not try to dismantle the system yourself: the dismantling of the air

conditioning system, treatment of the refrigerant, of oil and of other part must be done by a qualified installer in accordance with relevant local and national legislation. Air conditioners must be treated at a specialized treatment facility for reuse, recycling and recovery. By ensuring this product is disposed of correctly, you will help to prevent potential negative consequences for the environment and human health. Please contact the installer or local authority for more information. Battery must be removed from the remote controller and disposed of separately in accordance with relevant local and national legislation.

IMPORTANT INFORMATION REGARDING THE REFRIGERANT USED

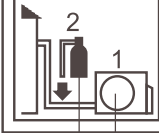
Contains fluorinated greenhouse gases covered by the Kyoto Protocol		A
R410A	1= <input type="text"/> kg	B
	2= <input type="text"/> kg	C
	1+2= <input type="text"/> kg	D
F	E	

This product contains fluorinated greenhouse gases covered by the Kyoto Protocol. Do not vent into the atmosphere.

Refrigerant type: R410A

GWP* value: 1975

GWP=global warming potential

Please fill in with indelible ink,

- 1 the factory refrigerant charge of the product
- 2 the additional refrigerant amount charged in the field and
- 1+2 the total refrigerant charge on the refrigerant charge label supplied with the product. The filled out label must be adhered in the proximity of the product charging port (e.g. onto the inside of the stop valve cover).

A contains fluorinated greenhouse gases covered by the Kyoto Protocol

B factory refrigerant charge of the product: see unit name plate

C additional refrigerant amount charged in the field

D total refrigerant charge

E outdoor unit

F refrigerant cylinder and manifold for charging

Cautions

Disposal of the old air conditioner

Before disposing an old air conditioner that goes out of use, please make sure it's inoperative and safe. Unplug the air conditioner in order to avoid the risk of child entrapment.

It must be noticed that air conditioner system contains refrigerants, which require specialized waste disposal. The valuable materials contained in a air conditioner can be recycled. Contact your local waste disposal center for proper disposal of an old air conditioner and contact your local authority or your dealer if you have any question. Please ensure that the pipework of your air conditioner does not get damaged prior to being picked up by the relevant waste disposal center, and contribute to environmental awareness by insisting on an appropriate, anti-pollution method of disposal.

Disposal of the packaging of your new air conditioner

All the packaging materials employed in the package of your new air conditioner may be disposed without any danger to the environment.

The cardboard box may be broken or cut into smaller pieces and given to a waste paper disposal service. The wrapping bag made of polyethylene and the polyethylene foam pads contain no fluorochloric hydrocarbon.

All these valuable materials may be taken to a waste collecting center and used again after adequate recycling. Consult your local authorities for the name and address of the waste materials collecting centers and waste paper disposal services nearest to your house.

Safety Instructions and Warnings

Before starting the air conditioner, read the information given in the User's Guide carefully. The User's Guide contains very important observations relating to the assembly, operation and maintenance of the air conditioner.

The manufacturer does not accept responsibility for any damages that may arise due to non-observation of the following instruction.

- Damaged air conditioners are not to be put into operation. In case of doubt, consult your supplier.
- Use of the air conditioner is to be carried out in strict compliance with the relative instructions set forth in the User's Guide.
- Installation shall be done by professional people, don't install unit by yourself.
- For the purpose of safety, the air conditioner must be properly grounded in accordance with specifications.
- Always remember to unplug the air conditioner before opening inlet grill. Never unplug your air conditioner by pulling on the power cord. Always grip plug firmly and pull straight out from the outlet.
- All electrical repairs must be carried out by qualified electricians. Inadequate repairs may result in a major source of danger for the user of the air conditioner.
- Do not damage any parts of the air conditioner that carry refrigerant by piercing or perforating the air conditioner's tubes with sharp or pointed items, crushing or twisting any tubes, or scraping the coatings off the surfaces. If the refrigerant spurts out and gets into eyes, it may result in serious eye injuries.
- Do not obstruct or cover the ventilation grille of the air conditioner. Do not put fingers or any other things into the inlet/outlet and swing louver.
- Do not allow children to play with the air conditioner. In no case should children be allowed to sit on the outdoor unit.
- This appliance is not intended for use by persons (including children) with reduced physical, sensory or mental capabilities, or lack of experience and knowledge, unless they have been given supervision or instruction concerning use of the appliance by a person responsible for their safety.
- Children should be supervised to ensure that they do not play with the appliance.

Cautions

Specifications

- The refrigerating circuit is leak-proof.

The machine is adaptive in following situation

- Applicable ambient temperature range:

Cooling	Indoor temperature	max. DB/WB min. DB/WB	32/23°C 18/14°C
	Outdoor temperature	max. DB/WB min. DB/WB	46/26°C 10/6°C
Heating	Indoor temperature	max. DB/WB min. DB/WB	27°C 15°C
	Outdoor temperature	max. DB/WB min. DB/WB	24/18°C -15°C

- If the supply cord is damaged, it must be replaced by the manufacturer or its service agent or a similar qualified person.
- If the fuse on PC board is broken please change it with the type of T 3.15A /250VAC. Please check the circuit diagram about the fuse replaced.
- The wiring method should be in line with the local wiring standard.
- The power cable and connecting cable are self-provided. All the cables shall have got the local authentication certificate.
- The breaker of the air conditioner should be all-pole switch; and the distance between its two contacts should be no less 3mm. Such means for disconnection must be incorporation in the fixed wiring.
- The waste battery shall be disposed properly.

Parts and Functions

AP48KS1ERA
AP60KS1ERA

AP48DS1ERA

AP48KS1ERA , AP60KS1ERA

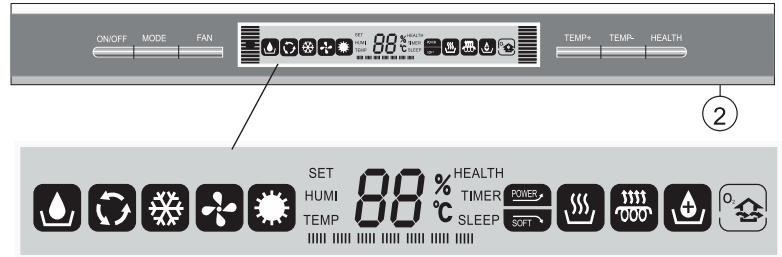
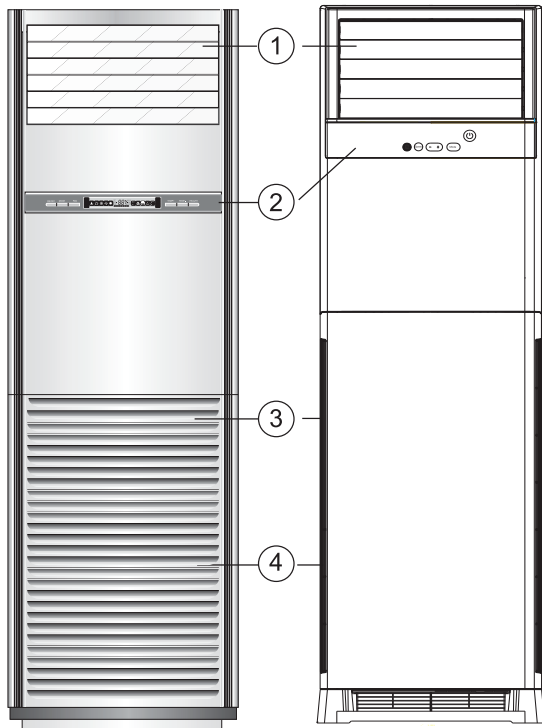

AP48DS1ERA

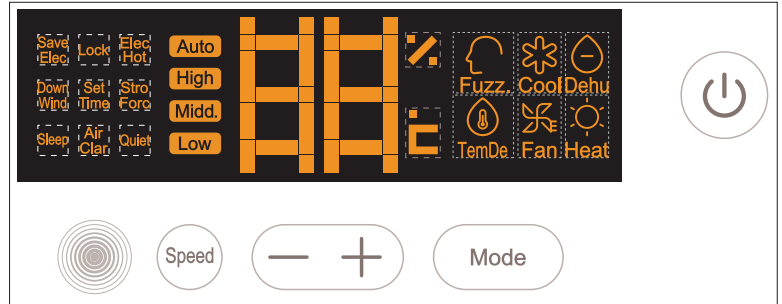

English

Indoor unit

- ① Outlet grill
- ② Operation panel
- ③ Inlet grill
- ④ Air filter (inside the unit)

Remote controller

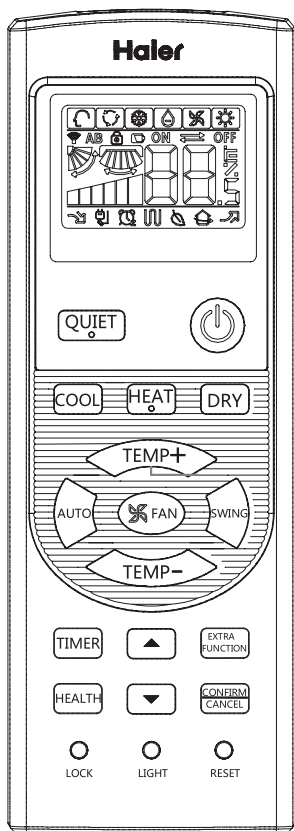

Outdoor unit

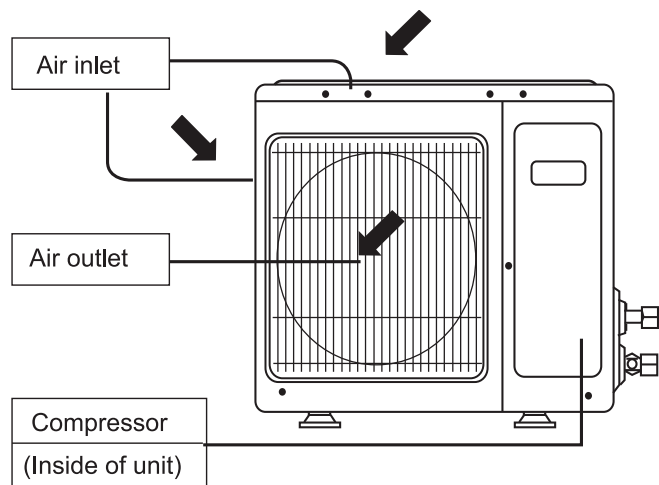

Parts and Functions

Remote controller

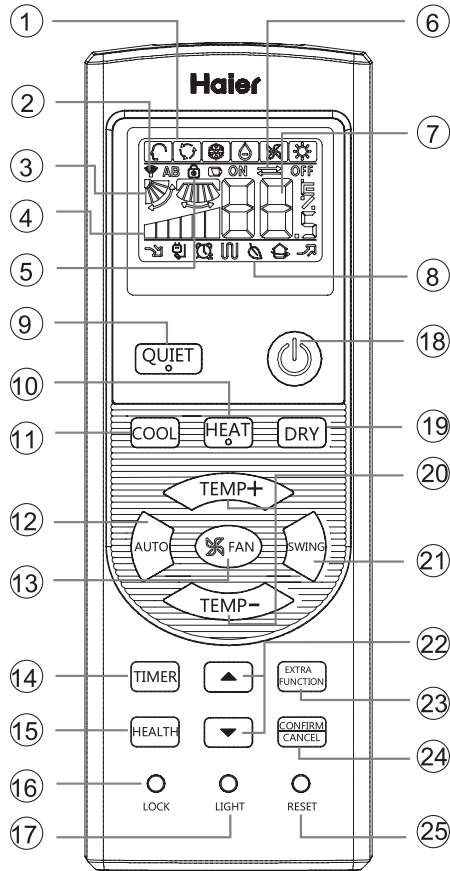

1. Mode display

Operation mode	AUTO	COOL	DRY	HEAT	FAN
Remote controller					

2. Signal sending display

3. SWING display

4. FAN SPEED display

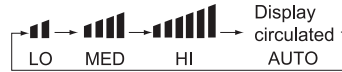

5. LOCK display

6. TIMER OFF display

TIMER ON display

7. TEMP display

8. Additional functions display

Operation mode	QUIET	SLEEP	Supplemental electrical heating	HEALTH	POWER
Remote controller					

Electrical heating is not available.

9. QUIET button

10. HEAT button

11. COOL button

12. AUTO button

13. FAN button

14. TIMER button

15. HEALTH button

(This model has not this function.)

16. LOCK button

Used to lock buttons and LCD display.

17. LIGHT button

(This model has not this function.)

Control the lightening and extinguishing of the indoor LED display board.

18. POWER ON/OFF button

19. DRY button

20. TEMP button

21. SWING button

22. HOUR button

23. EXTRA FUNCTION button

Function: Fan only function , health airflow upwards and downwards sending function,sleep function, air-refresh(reserved function) Fahrenheit Celsius conversion Power setting function left and right swing function ,10°C heating function

24.CANCEL/CONFIRM button

Function: Setting and cancel to the timer and other additional functions.

25. RESET button

When the remote controller appears abnormal, use a sharp pointed article to press this button to reset the remote

Loading of the battery

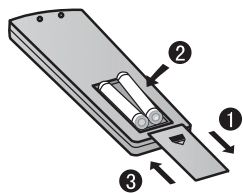

1 Remove the battery cover;

2 Load the batteries as illustrated.
2 R-03 batteries, resetting key (cylinder);

3 Be sure that the loading is in line with the "+" / "-";

4 Load the battery, then put on the cover again.

Note:

- The distance between the signal transmission head and the receiver hole should be within 7m without any obstacle as well.
- When electronic-started type fluorescent lamp or change-over type fluorescent lamp or wireless telephone is installed in the room, the receiver is apt to be disturbed in receiving the signals, so the distance to the indoor unit should be shorter.
- Full display or unclear display during operation indicates the batteries have been used up. Please change batteries.
- If the remote controller can't run normally during operation, please remove the batteries and reload several minutes later.

Hint:

Remove the batteries in case won't be in use for a long period. If there is any display after taking-out, just press reset key.

Operation

Base Operation

Remote controller

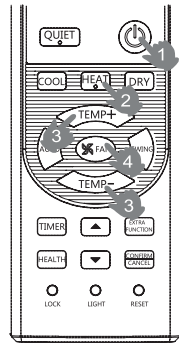

- Unit start**
Press ON/OFF on the remote controller, unit starts.
- Select operation mode**
COOL button: Cooling mode
HEAT button: Heating mode
DRY button: Dehumidify mode
- Select temp.setting**
Press TEMP+ / TEMP- button
TEMP+ Every time the button is pressed, temp.setting increase 1°C, if kept depressed, it will increase rapidly
TEMP- Every time the button is pressed, temp.setting decrease 1°C, if kept depressed, it will decrease rapidly
Select a desired temperature.
- Fan speed selection**
Press FAN button. For each press, fan speed changes as follows:
Remote controller:

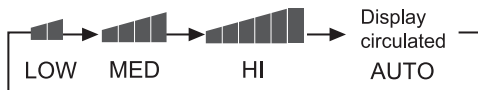

Air conditioner is running under displayed fan speed. When FAN is set to AUTO, the air conditioner automatically adjusts the fan speed according to room temperature.

Operation Mode	Remote Controller	Note
AUTO		Under the mode of auto operation air conditioner will automatically select Cool or Heat operation according to room temperature. When FAN is set to AUTO the air conditioner automatically adjusts the fan speed according to room temperature.
COOL		
DRY		In DRY mode, when room temperature becomes lower than temp.setting+2° C, unit will run intermittently at LOW speed regardless of FAN setting.
HEAT		In HEAT mode, warm air will blow out after a short period of the time due to cold-draft prevention function. When FAN is set to AUTO, the air conditioner automatically adjusts the fan speed according to room temperature.
FAN		In FAN operation mode, the unit will not operate in COOL or HEAT mode, but only in FAN mode. AUTO is not available in FAN mode. And temp. setting is disabled. In FAN mode, sleep operation is not available.

Sleep Operation

Press button to enter additional options, when cycle display to , will flash. And then press enter to sleep function.



Operation Mode

- In COOL, DRY mode**
1 hours after SLEEP mode starts, temp. will become 1°C higher than temp. setting. After another 1 hours, temp. rises by 1°C further. The unit will run for further 6 hours then stops. Temp. is higher than temp. setting so that room temperature won't be too low for your sleep.

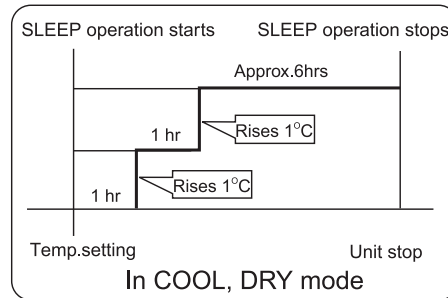

2. In HEAT mode

- In HEAT mode**
1 hours after SLEEP mode starts, temp will become 2°C lower than temp. setting. After another 1 hours, temp decrease by 2°C further. After more another 3 hours, temp. rises by 1°C further. The unit will run for further 3 hours then stops. Temp. is lower than temp. setting so that room temperature won't be too high for your sleep.

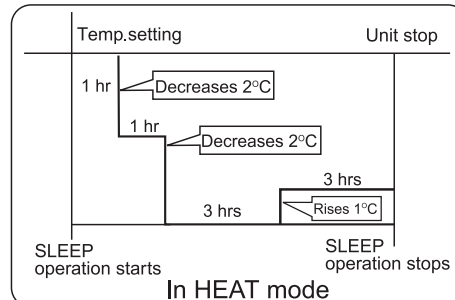

3. In AUTO mode

The unit operates in corresponding sleep mode adapted to the automatically selected operation mode.

Operation

4. In FAN mode

It has no SLEEP function.

5. Set the wind speed change when sleeping

If the wind speed is high or middle before setting for the sleep, set for lowering the wind speed after sleeping.

If it is low wind, no change.





Note

When TIMER function is set, the sleeping function can't be set up. After the sleeping function is set up, if user resets TIMER function, the sleeping function will be cancelled; the machine will be in the state of timing-on.

POWER/QUIET Operation

(1) POWER Operation

When you need rapid heating or cooling, you can use this function.

Press  button to enter additional options, when cycle display to ,  will flash, and then press , enter to power function. When cancel the function, please enter additional options again and to cancel power function.

(2) QUIET Operation

You can use this function when silence is needed for rest or reading.

Press QUIET button, the remote controller will show , and then achieve to the quiet function. Press again this QUIET button, the quiet function will be cancelled.

Note :

During POWER operation, in rapid HEAT or COOL mode, the room will show inhomogeneous temperature distribution. Long period QUIET operation will cause effect of not too cool or not too warm.

Air Flow Direction Adjustment

1. Status display of air flow

COOL/DRY:

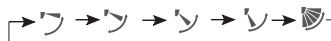

HEAT:



2. Left and right air flow adjustment

(This model has not this function.)

Timer On/Off On-Off Operation

1. After unit starts, select your desired operation mode.
2. Press TIMER button to change TIMER mode. Every time the button is pressed, display changes as follows:
Remote controller:

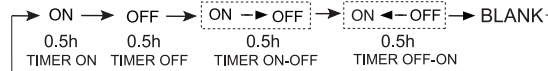

Then select your desired TIMER mode (TIMER ON or TIMER OFF or TIMER ON-OFF). " ON "or " OFF "will flash.

3. Press  /  button to set time.

 Press the button for each time, setting time in the first 12 hours increased by 0.5 hour every time, after 12 hours, increased by 1 hour every time.

 Press the button for each time, setting time in the first 12 hours decreased by 0.5 hour every time, after 12 hours, decreased by 1 hour every time. It can be adjusted within 24 hours.

4. Confirm timer setting

After adjust the time, press  button and confirm the time ON or OFF button will not flash any more.

5. Cancel timer setting

Press the timer button by times until the time display eliminated.

Hints:

After replacing batteries or a power failure happens, time setting should be reset.



According to the Time setting sequence of TIMER ON or TIMER OFF, either Start-Stop or Stop-Start can be achieved.

Healthy airflow Operation

1. Press  to starting



Setting the comfort work conditions.

2. The setting of healthy airflow function

Press  button to enter additional options, Press this button continuously, the louvers location will cycle between in the following three locations, to choose the swing location what you needed, and then press  button to confirm.



3. The cancel of the healthy airflow function

Press  button to enter additional options, Press this button continuously, the louvers location will cycle between in the following three locations again, and then press  button to cancel.

Notice: Do not direct the flap by hand. Otherwise, the grille will run incorrectly. If the grille is not run correctly, stop for a minute and then start, adjusting by remote controller.

Note:

1. After setting the healthy airflow function, the position grill is fixed.

2. In heating, it is better to select the  mode.

3. In cooling, it is better to select the  mode.

4. In cooling and dry, using the air conditioner for a long time under the high air humidity, condensate water may occur at the grille.

Energy Saving

Keep proper room temperature

Too cold or too warm is no good to your health, and power consumption will be increased as well.

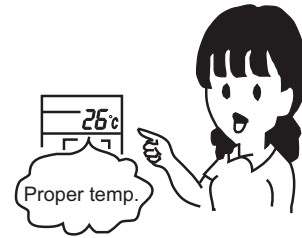

Air filter should be periodically cleaned

If air filter is clogged, it will cause poor cooling and heating efficiency, higher power consumption and even problem may occur. In cooling operation, water will flow out.

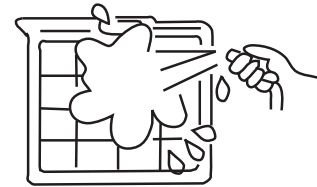

Use Timer effectively

You may use Timer mode to keep a comfortable room temp. when you wake up or come home from outside.

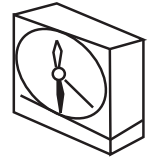
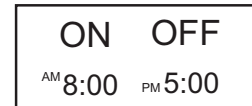





Avoid direct sunlight and air flow



Adjust air flow properly

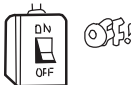

Maintenance

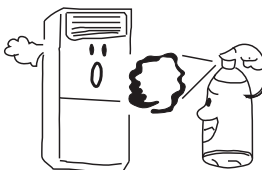
<p>Disconnect power supply</p> 	<p>Don't touch it with wet hand</p> 	<p>Don't wash with hot water or solvent to clean the unit</p> 
<p>Don't splash water directly on indoor unit.</p> 		<p>Don't spray any paint or insecticide on the unit.</p>  <p>This will cause damage or even fire accident.</p>

Air filter cleaning

- Pull it out from top as shown in Fig.
- Use water or vacuum cleaner to clean it. If it is extremely dirty, wash it with neutral detergent or soap water.
- Wash it with clean water and install it after complete dry.

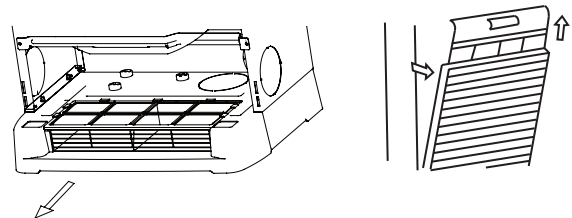

Caution:

- Don't use hot water over 40°C, as this may cause damage to air filter. Wipe air filter carefully.



Indoor and outdoor cleaning

- Clean it with warm and wet cloth or with neutral detergent, then wipe it dry with clean and soft cloth.
- If air conditioner is very dirty, clean it with cloth soaked in neutral detergent, then wipe off the detergent with clean water.
- Don't use water higher than 40°C, which will cause discoloring and deformation.
- Don't use insecticide or other chemical detergents.

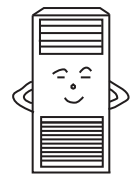

After season maintenance

- Let the unit run in Fan mode for half a day in a fine weather to dry completely the unit inside.
- Turn off the unit and pull out power plug. Otherwise, there might be certain power consumption even if the unit is stopped.
- Clean air filter and indoor unit, cover outdoor unit after cleaning.

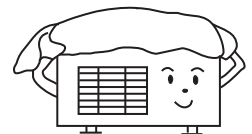





Before season maintenance

- Check if there are obstacles at inlet and outlet of indoor and outdoor unit, which will reduce unit efficiency.
- Don't fail to attach air filter after making sure it is cleaned. Dust will enter into unit causing damages or faults if it is running without air filter.
- To protect compressor at start, please connect external power supply to the unit 12 hrs prior to starting. Also please keep the power supply switch ON during the whole season.

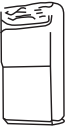

Troubleshooting

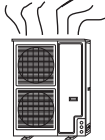

Followings are not problems

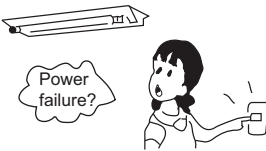

<p>Sound of water flowings are not problems.</p> 	<p>During unit start and operation or at stop, a swishing or gurgling noise may be heard. This noise is generated by refrigerant flowing in the system.</p>
<p>Sound of cracking is heard.</p>	<p>During unit operation, a cracking noise may be heard. This noise is generated by the casing expanding or shrinking because of temperature changes.</p>
<p>Smells are generated.</p>	<p>This is because the system circulates smells from the interior air such as the smell of cigarettes or the painting on the unit.</p>
<p>During operation, white fog or steam comes out of indoor unit.</p> 	<p>When unit is running at places like restaurant where dense edible oil fumes always exist, this will happen.</p>
<p>In cooling operation, unit switches to fan operation.</p>	<p>To prevent frost from accumulating on indoor heat exchanger, unit will switch to fan operation for a while and then resume cooling operation.</p>
<p>Unit will not restart after stop.</p> <p>Won't start?</p> 	<p>Though ON/OFF button is set to ON, the unit won't resume cooling, dry or heating operation in 3 min after it is stopped, this is because of 3-min-delay protection circuit.</p>  <p>Please wait 3 minutes</p>
<p>No outlet air or fan speed can't be changed in dry mode.</p>	<p>Unit will reduce fan speed repeatedly and automatically if room temp. is too low in dry operation.</p>
<p>In heating operation, water or steam are blown out of indoor unit.</p> 	<p>This occurs when frost accumulated on the outdoor unit is removed. (during defrosting operation)</p> 
<p>In heating operation, indoor fan won't stop even if unit is stopped.</p>	<p>After unit stops, indoor fan will go on running until indoor unit cools down.</p>

Troubleshooting

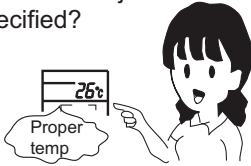
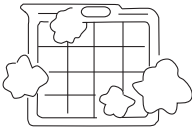
Before asking services, please firstly check your unit according to following.

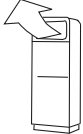
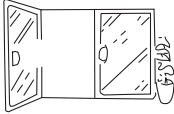
Air conditioner won't start.		
<p>Is power supply switch turned on?</p>  <p>Power supply switch is not set at ON.</p>	<p>Is city power supply normal?</p>  <p>Power failure?</p>	<p>Is leakage current breaker activated?</p> <p>This is very dangerous, please disconnect power supply immediately and contact your dealer.</p>

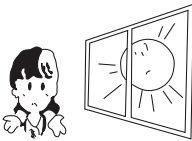
Poor cooling or heating		
<p>Are operation controls adjusted correctly as specified?</p>  <p>Proper temp</p>	<p>Is air filter too dirty?</p> 	<p>Are there any obstacles at inlet or outlet grill?</p> 
<p>Are horizontal louvers at up position (in heating mode)?</p> 	<p>Any doors or windows left open?</p> 	

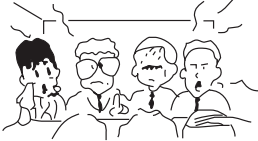
Poor cooling		
<p>Is there any direct sunlight in the room?</p> 	<p>If there are unexpected heat sources in the room?</p> 	<p>Too many people in the room?</p> 

If your unit still can't work properly after above mentioned checks, or following problems occur, please stop it immediately and contact your dealer.

- Fuses or circuit breakers often blow out.
- Water comes out in cooling/dry operation.
- Operation is abnormal or sound is heard.

Troubleshooting

When failure happens, the fan of indoor unit stop running. The method of check failure code as follow.

Diagnosis

Failure	LED display	Timed led flash times (Indoor unit PCB LED 4)	Running LED flash times(Indoor unit PCB LED 3)
Faulty temperature Te	E3	3	0
Faulty temperature Ta	E3	3	2
Faulty temperature Ts	E3	3	1
Faulty temperature Td	E3	3	3
High pressure switch abnormal	E6	6	2
Low pressure switch abnormal	E6	6	3
Low pressure protection(lack of R410A)	E6	3	6
Outdoor EEPROM failure	EE	2	1
Communication abnormal between indoor and outdoor	E9	3	2
Protection of over current of compressor among phases/wrong phases	E5	2	3
Protection of low current of compressor	E5	4	5
Outdoor DC motor abnormal	F6	2	9
Outdoor discharging temp.sensor abnormal	E4	2	8
4-way valve reverse abnormal in heating mode	F2	3	7
Power source too high/low voltage protection	E7	2	8
Indoor environment sensor abnormal	E1	0	1
Indoor coil sensor abnormal	E2	0	2
Indoor EEPROM failure	F8	0	4
Indoor anti-freezed protection	F5	0	5
Failure communication between indoor and outdoor	E9	0	7
Failure communication between wired controller	E8	0	8
Protection of overload of heat mode	F4	0	9
Drainage system abnormal	E0	0	12
No zero cross signal input	EF	0	13
Be lack of phase failure	E10	0	14
Failure of aided coil sensor	ED	0	15
Indoor abnormal mode operation	F3	0	16
Other frequency conversion outdoor failures	F7		

1. For the indoor failure, only running LED ON remote receiver will indicate.
2. For the outdoor failure, timer LED and running LED will indicate. timer LED of remote receiver stands for ten's place, and running LED stands for one's place. timer LED will flash firstly, 2 seconds later, running LED will flash too. After that, 4 seconds later, they will flash in turns again. Flash times equals to the failure code of outdoor plus.
20. For example, failure code of outdoor is 2, the indoor unit should display 22. As a result, timer LED flashes twice firstly, then running LED flashes twice.
3. To get much more details of outdoor unit failure, please refer to the outdoor unit trouble shooting list.

Indoor & Outdoor Unit Connection

Installation figure please refers to AP60KS1ERA

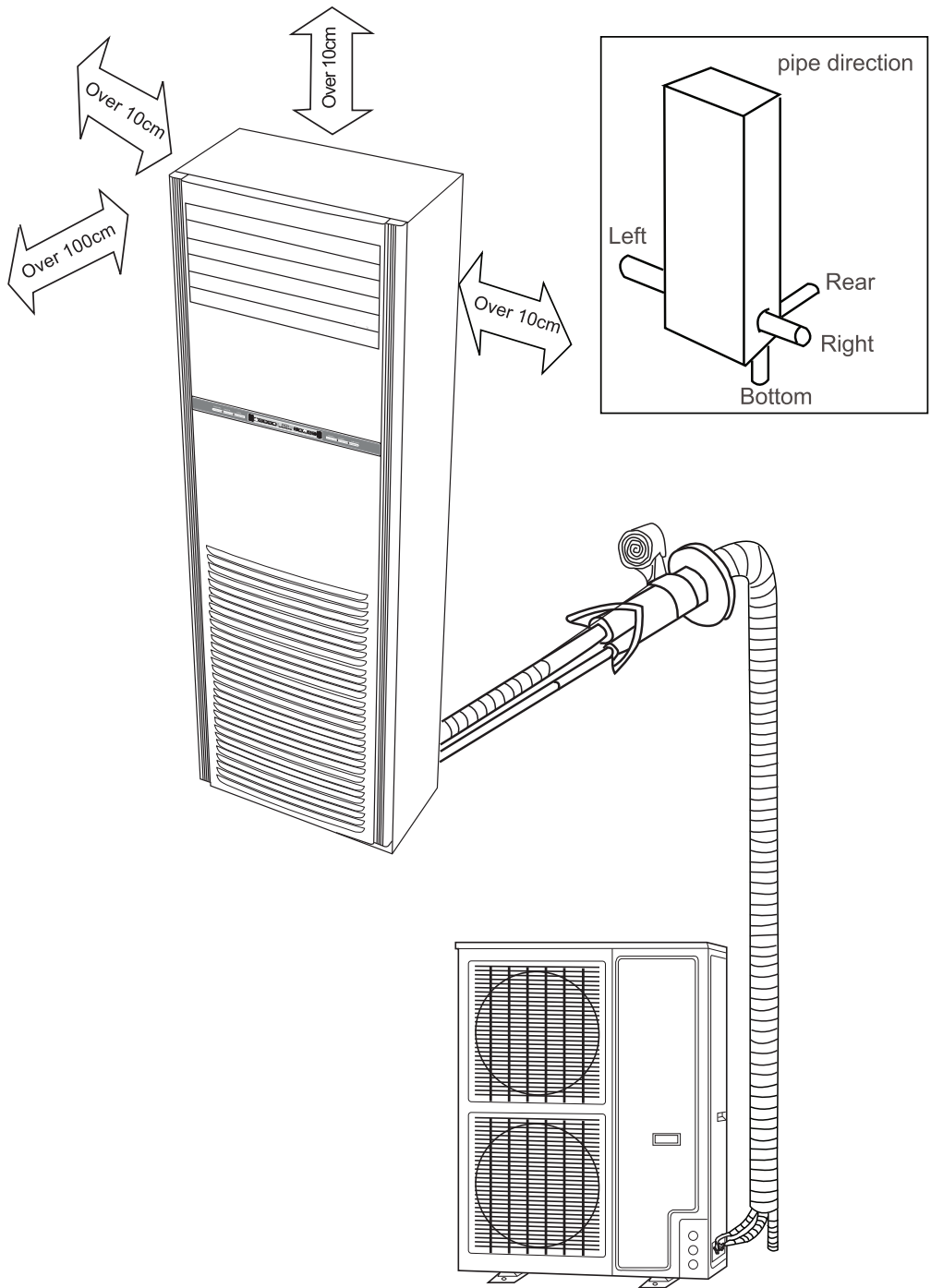

Tools necessary

1. Screw driver
2. Hacksaw
3. 70mm dia. hole core drill
4. Spanner (dia. 22, 36mm)
5. Spanner (16, 18, 22, 36mm)
6. Pipe cutter
7. Flaring tool
8. Knife
9. Nipper
10. Gas leakage detector or soap water
11. Measuring tape
12. Reamer
13. Refrigerant oil

Installation accessories

Following parts shall be field supplied

Part name
Adhesive tape
Pipe clip
Connecting hose
Insulation material
Putty
Drain hose

Installation Procedure

Outdoor Unit

Before installation

- Try to bring the packed unit to the installation place.
- When it is inevitable to unpack the unit, be careful not to damage the unit. Wrap it with nylon etc.
- After unpacking, be sure to put it with the front side of the unit facing up.
- When delivering, don't hold plastic parts like inlet and outlet grill etc.

Delivery

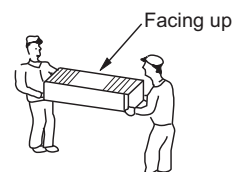

Installation of outdoor unit

Selection of outdoor unit installation place

- Place strong enough to support the unit and will not cause vibration and noise.
- Place where discharged wind and noise doesn't cause a nuisance to the neighbors.
- Place where is less affected by rain or direct sunlight and is sufficiently ventilated, or to install a shield.
- Place with enough space for smooth air flow.

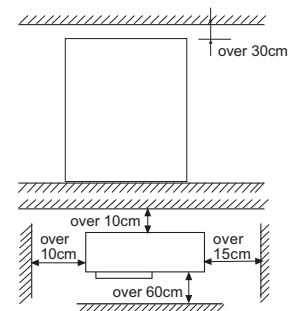

Fixing of the outdoor unit

- Fix outdoor unit using M10 bolt to concrete floor horizontally.
- If installed on the wall or on top of a roof, bracket should be fixed securely to resist earthquake or storms.
- Use rubber pad during installation against unit vibration.

Selection of indoor unit installation place

- Place where it is easy to route drainage pipe and outdoor piping.
- Place away from heat source and with less direct sunlight.
- Place where cool and warm air could be delivered evenly to every corner of the room.
- Place near power supply socket. Leave enough space around the unit (refer to installation drawings).

Installation of indoor unit

1. Position of the wall hole

Wall hole should be decided according to installation place and piping direction. (refer to installation drawings)

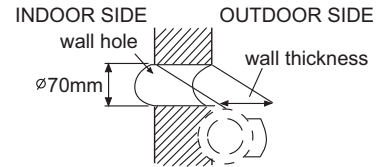

(Cross section of wall hole)

2. Making a wall hole

Drill a hole of 70mm dia. with a little slope towards outside.
Install piping hole cover and seal it with putty after installation.

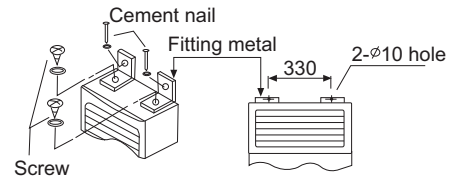

3. Fixing of indoor unit

With the unit set up vertically, fix the fitting metal to the unit with screws, then fix the fitting metal to the wall with cement nail and washer, as shown right:

Moreover, if wanting to fix the unit more firmly, you should fix the bottom panel to the ground with concrete bolts, as shown right:

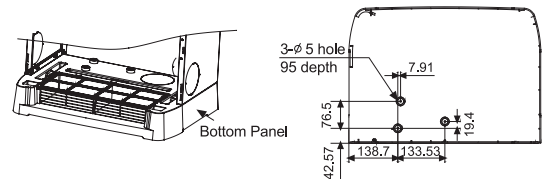
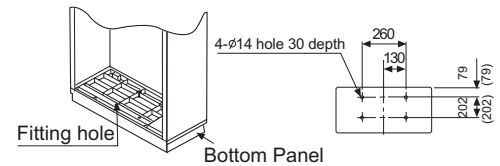

Connecting method







- Apply refrigerant oil at half union and flare nut.
- To bend a pipe, give the roundness as large as possible not to crash the pipe.
- When connecting pipe, hold the pipe centre to centre then screw nut on by hand, refer to Fig.
- Be careful not to let sundries, such as sands enter the pipe.

Pipe cutting and flaring

- Be sure to carry out deburring after pipe cutting with a pipe cutter.
- Insert flaring tool to make a flare.

Forced fastening without centering may damage the threads and cause a gas leakage.

	Pipe dia.	Dimension A	Fastening torque
Liquid pipe	∅ 9.52mm (3/8")	1.0 ~ 1.8(mm)	32.7-39.9N.m
Gas pipe	∅ 19.05mm (3/4")	1.4 ~ 2.2(mm)	97.2-118.6N.m

Correct	Incorrect				
					
	Lean	Damaged flare	Crack	Partial	Too outside

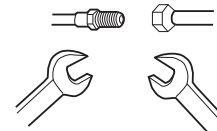
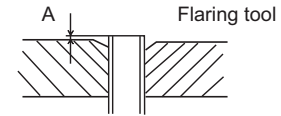

control box

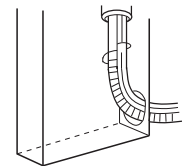

Piping connection of indoor unit

1. Arrangement of piping and drainage pipe

- After opening inlet grill, you will see a control box as shown in the Fig. Remove the cover before wiring work.

- Cut away, with a hammer or a saw, the lid for piping according to piping direction.

- According to the piping method, connect the piping on indoor unit with union of connecting pipe.

Arrange the piping as per the wall hole and bind drain hose, connecting electric cable and piping together with polyethylene tape.

Insert the bound piping, connecting electric cable and drain hose through wall hole to connect with outdoor unit.

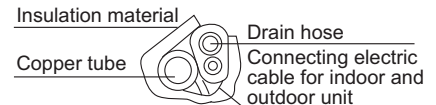

2. Arrangement of drain hose

- Drain hose shall be placed in under place.
- There should be a slope when arrange drain hose. Avoid up and down waves in drain hose.
- If humidity is high, drain pipe(especially in room and indoor unit) must be covered with insulation material.

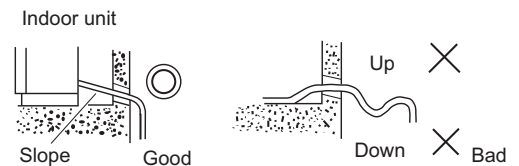

Piping connection of outdoor unit.

Connect the connecting pipe and inlet / outlet liquid pipe according to the piping method.

Vacuumizing

Discharge the air out of the indoor unit and the refrigerant pipe by vacuumizing.

- (1) Fasten all the nuts of the indoor and outdoor pipes to make these parts out of leakage.
- (2) Under the condition of the complete close of the indoor and outdoor valve center (both liquid and gas side), dismantle the service valve cap. Vacuumizing through the charge mouth of the service valve.
- (3) After vacuumizing, fasten the service valve and dismantle the cap of the big and small stop valve, then loosen the stop valve center completely and fasten the big and small stop valve.

Note:

- Electrical wiring must be done by qualified person.
- The power supply connects from the outdoor unit.
- The connecting cable and power cable are self-provided.
- Use copper wire only.
- Air conditioner must use an exclusive line (over 30A)
- When installing air conditioner in a wet place, try to use a circuit breaker against current leakage.
- When installing in other places, use circuit breaker as far as possible.
- The breaker of the air conditioner should be all-pole switch; and the distance between its two contacts should be no less than 3 mm.
- Such means for disconnection must be incorporated in the fixed wiring

The parameter of connecting cable is H05RN-F 4G 2.5mm².
 The parameter of the power cable should be over H07RN-F 5G 4.0mm²

Wiring of indoor unit

- Insert the cable from outside the wall hole where piping already exist.
- Pull it out from front.
- Loosen terminal screws and insert cable end fully into terminal block, then tighten it.
- Pull the cable gently to make sure it is tight.
- Replace cover after wiring.

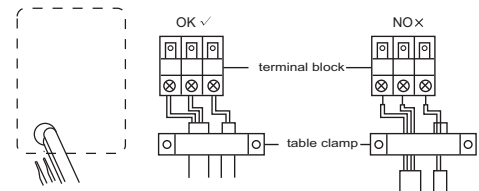

Wiring of outdoor unit

- Insert the cable from inside the wall hole where piping already exists.
- Pull it out from front.
- Loose terminal screw and insert cable end fully into terminal block, then tighten it.
- Pull the cable gently to make sure it is tight.
- Replace cover after wiring.

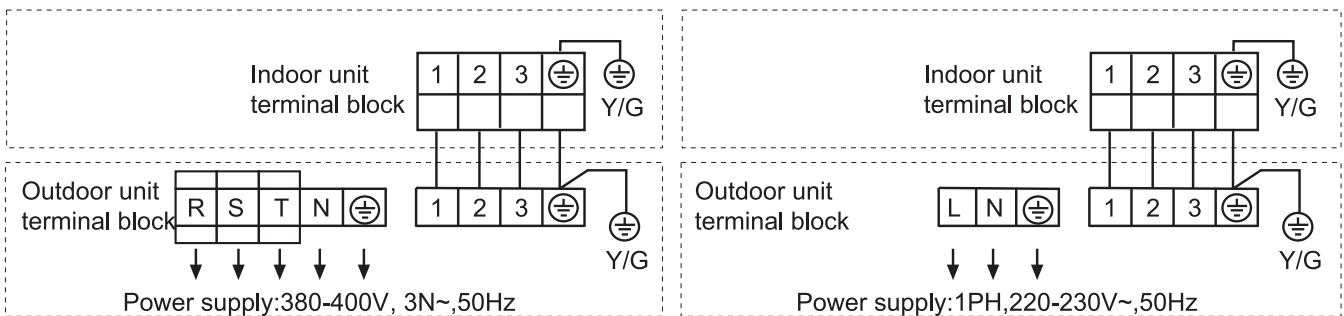

Note:

When connecting indoor and outdoor wire, check the number on indoor and outdoor terminal blocks. Incorrect wiring may damage air conditioner's controller or cause operation failure.