

Operating Instructions

Blu-ray Disc™ Player

Model No. DMP-BBT01



Thank you for purchasing this product.
For optimum performance and safety, please read these instructions carefully.
Please keep this manual for future reference.

Region management information

BD-Video

This unit can play BD-Video discs supporting the region code "B".

Example:



DVD-Video

This unit can play DVD-Video discs supporting the region number "2" or "ALL".

Example:



Model number suffix "EB" denotes UK model.

Information for Users on Collection and Disposal of Old Equipment and used Batteries



These symbols on the products, packaging, and/or accompanying documents mean that used electrical and electronic products and batteries should not be mixed with general household waste.

For proper treatment, recovery and recycling of old products and used batteries, please take them to applicable collection points, in accordance with your national legislation and the Directives 2002/96/EC and 2006/66/EC.

By disposing of these products and batteries correctly, you will help to save valuable resources and prevent any potential negative effects on human health and the environment which could otherwise arise from inappropriate waste handling.

For more information about collection and recycling of old products and batteries, please contact your local municipality, your waste disposal service or the point of sale where you purchased the items.

Penalties may be applicable for incorrect disposal of this waste, in accordance with national legislation.

For business users in the European Union

If you wish to discard electrical and electronic equipment, please contact your dealer or supplier for further information.

[Information on Disposal in other Countries outside the European Union]

These symbols are only valid in the European Union. If you wish to discard these items, please contact your local authorities or dealer and ask for the correct method of disposal.

Note for the battery symbol (bottom two symbol examples):

This symbol might be used in combination with a chemical symbol. In this case it complies with the requirement set by the Directive for the chemical involved.



Cd

CAUTION	- VISIBLE AND INVISIBLE LASER RADIATION WHEN OPEN. DO NOT STARE INTO BEAM. FDA 21CFRCLASS II (Eal)
CAUTION	- CLASS 2 VISIBLE AND INVISIBLE LASER RADIATION WHEN OPEN. DO NOT STARE INTO THE BEAM. IEC00825-1:CLASS 2
ATTENTION	- RAYONNEMENT LASER VISIBLE ET INVISIBLE, CLASSE 2. EN CAS D'OUVERTURE, NE PAS REGARDER DANS LE FAISCEAU.
FORSIGTIG	- SYNLIG OG USYNLIG LASERSTRÅLING KLASSE 2, NÅR LÅGET ER ÅBENT, UNGDÅ AT SE LIGE IND I STRÅLEN.
VARO	- AVATTAESSA OLET ALTTIINA LUOKAN 2 NÄKYVÄÄ JA NÄKYMÄTÖNTÄ LASERSTRÄLYÄ, ÄLÄ TILUJOTA SÄTEESEEN.
VARNING	- KLASS 2 SYNLIG OCH OSYNLIG LASERSTRÅLNING NÄR DENNA DEL ÄR ÖPPNAD, STIRRA EJ IN I STRÅLEN.
VORSICHT	- SICHTBARE UND UNSICHTBARE LASERSTRAHLUNG KLASSE 2. WENN ABDECKUNG GEÖFFNET, NICHT IN DEN STRAHL BLICKEN.
注意	- 打开时有可见及不可见激光辐射。避免光束照射。
注意	- ここを開くとクラス2の可視及び不可視レーザー放射が出る ビームなので見えないこと。 VQL2P54

(Inside of product)



(Back of product)



Table of contents

Getting started

Caution for AC Mains Lead	3
Safety precautions	4
Accessories	5
Unit and media care	5
Playable media	6
Control reference guide	8
Using the touchpad	10

Connections and settings

STEP 1 : Installing the Unit	12
STEP 2 : Connecting to a TV	13
STEP 3 : Connecting to an amplifier/receiver	14
STEP 4 : Connecting to the network	15
STEP 5 : Connecting the AC mains lead	15
STEP 6 : Settings	16
STEP 7 : Reprogramming the remote control	18

Playback

Inserting or removing media	19
HOME menu	19
Multi User Mode	20
Playback	21
VIERA Connect (Enjoying Internet Service)	25
Home Network feature	26
VIERA Link "HDAVI Control™"	28

Settings

Option menu	29
Setup menu	32

Reference

Indicator illumination	38
Messages	39
Troubleshooting guide	40
Specifications	44
Precautions for wireless LAN connection	45
Supplemental information	45

- **Restriction on use of unauthorized copied content (⇒ 43)**
- **Firmware updates (⇒ 18)**



Caution for AC Mains Lead

For your safety, please read the following text carefully.

This appliance is supplied with a moulded three pin mains plug for your safety and convenience.

A 5-ampere fuse is fitted in this plug.

Should the fuse need to be replaced please ensure that the replacement fuse has a rating of 5-ampere and that it is approved by ASTA or BSI to BS1362.

Check for the ASTA mark  or the BSI mark  on the body of the fuse.

If the plug contains a removable fuse cover you must ensure that it is refitted when the fuse is replaced.

If you lose the fuse cover the plug must not be used until a replacement cover is obtained.

A replacement fuse cover can be purchased from your local dealer.

Before use

Remove the connector cover.

How to replace the fuse

The location of the fuse differ according to the type of AC mains plug (figures A and B). Confirm the AC mains plug fitted and follow the instructions below.

Illustrations may differ from actual AC mains plug.

1. Open the fuse cover with a screwdriver.

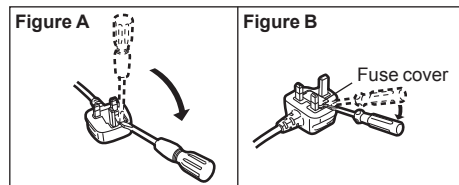

2. Replace the fuse and close or attach the fuse cover.

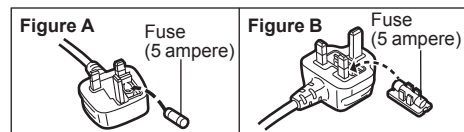

Safety precautions

WARNING

Unit

- To reduce the risk of fire, electric shock or product damage,
- Do not expose this unit to rain, moisture, dripping or splashing.
 - Do not place objects filled with liquids, such as vases, on this unit.
 - Use only the recommended accessories.
 - Do not remove covers.
 - Do not repair this unit by yourself. Refer servicing to qualified service personnel.
 - Do not let metal objects fall inside this unit.
 - Do not place heavy items on this unit.

AC mains lead

- To reduce the risk of fire, electric shock or product damage,
- Ensure that the power supply voltage corresponds to the voltage printed on this unit.
 - Insert the mains plug fully into the socket outlet.
 - Do not pull, bend, or place heavy items on the lead.
 - Do not handle the plug with wet hands.
 - Hold onto the mains plug body when disconnecting the plug.
 - Do not use a damaged mains plug or socket outlet.

Install this unit so that the AC mains lead can be unplugged from the socket outlet immediately if any problem occurs.

Small object

- Keep the Memory Card out of reach of children to prevent swallowing.
- Keep the screw out of reach of children to prevent swallowing.

CAUTION

Unit

- This unit utilizes a laser. Use of controls or adjustments or performance of procedures other than those specified herein may result in hazardous radiation exposure.
- Do not place sources of naked flames, such as lighted candles, on this unit.
- This unit may receive radio interference caused by mobile telephones during use. If such interference occurs, please increase separation between this unit and the mobile telephone.
- This unit is intended for use in moderate climates.

Placement

Place this unit on an even surface.

- To reduce the risk of fire, electric shock or product damage,
- Do not install or place this unit in a bookcase, built-in cabinet or in another confined space. Ensure this unit is well ventilated.
 - Do not obstruct this unit's ventilation openings with newspapers, tablecloths, curtains, and similar items.
 - Do not place the unit on amplifiers/receivers or equipment that may become hot. The heat can damage the unit.
 - Do not expose this unit to direct sunlight, high temperatures, high humidity, and excessive vibration.

Batteries

Mishandling of batteries can cause electrolyte leakage and may cause a fire.

- Danger of explosion if battery is incorrectly replaced. Replace only with the type recommended by the manufacturer.
- When disposing the batteries, please contact your local authorities or dealer and ask for the correct method of disposal.
- Do not mix old and new batteries or different types at the same time.
- Do not heat or expose to flame.
- Do not leave the battery(ies) in a car exposed to direct sunlight for a long period of time with doors and windows closed.
- Do not take apart or short circuit.
- Do not recharge alkaline or manganese batteries.
- Do not use batteries if the covering has been peeled off.

Remove batteries if you do not intend to use the remote control for a long period of time. Store in a cool, dark place.

AC adaptor

The AC adaptor operates on AC between 100 V and 240 V. But obtain a suitable plug adaptor if the plug does not fit the AC mains socket.

Accessories

Check the supplied accessories before using this unit.

- 1 **Remote control**
(N2QAYB000711)
- 2 **Batteries for remote control**
 - 1 **AC adaptor**
(RFEA221W)
 - 1 **AC mains lead**
(K2CT2YY00003)
 - 1 **HDMI cable**
(K1HY19YY0012)
 - 1 **Pedestal**
(RFA3406)



- Product numbers provided in these operating instructions correct as of April 2012. These may be subject to change.
- Do not use AC mains lead with other equipment.

■ Using the remote control

Insert so the poles (+ and -) match those in the remote control.

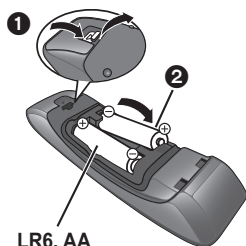

LR6, AA
(Alkaline batteries)

Point it at the remote control signal sensor on this unit. (⇒ 9)

Unit and media care

■ Clean this unit with a soft, dry cloth

- Never use alcohol, paint thinner or benzine to clean this unit.
- Before using chemically treated cloth, carefully read the instructions that came with the cloth.

■ This unit's lens

The disc drive of this unit has sufficient dust resistance, so there is no need to clean the lens.

■ Clean discs

DO

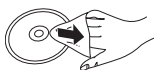

DO NOT



Wipe with a damp cloth and then wipe dry.

■ Disc and card handling precautions







- Handle discs by the edges to avoid inadvertent scratches or fingerprints on the disc.
- Do not attach labels or stickers to discs.
- Do not use disc cleaning sprays, benzine, thinner, static electricity prevention liquids or any other solvent.
- Clean any dust, water, or foreign matter from the terminals on the rear side of the card.
- Do not use the following discs:
 - Discs with exposed adhesive from removed stickers or labels (rented discs, etc.).
 - Discs that are badly warped or cracked.
 - Irregularly shaped discs, such as heart shapes.

■ To dispose or transfer this unit

The unit may keep the user settings information in the unit. If you discard this unit either by disposal or transfer, then follow the procedure to return all the settings to the factory presets to delete the user settings. (⇒ 40, "To return all settings to the factory preset.")

- The operation history may be recorded in the memory of this unit.

Playable media

Device	Disc markings	Device types	Contents format
BD		BD-Video	Video
		BD-RE	Video, JPEG, MPO
		BD-R	Video, DivX®, MKV
DVD		DVD-Video	Video
		DVD-R	Video, AVCHD, DivX®, MKV, JPEG, MPO, FLAC, MP3, WAV
		DVD-R DL	
		DVD-RW	Video, AVCHD
	—	+R/+RW/+R DL	
CD		Music CD	Music [CD-DA]
	—	CD-R CD-RW	DivX®, MKV, JPEG, MPO, FLAC, MP3, Music [CD-DA], WAV
SD		SD Memory Card (from 8 MB to 2 GB) SDHC Memory Card (from 4 GB to 32 GB) SDXC Memory Card (48 GB, 64 GB) (Compatible with both mini and micro types)	AVCHD, AVCHD 3D, MP4, MPEG2, JPEG, MPO
USB	—	USB devices (up to 2 TB)	DivX®, MKV, MP4, MPEG2, JPEG, MPO, FLAC, MP3, WAV

- See pages 7 and 44 for more information on the types of content that can be played.

■ Discs that cannot be played by this unit

- DVD-RAM
- Super Audio CD
- Photo CD
- DVD-Audio
- Video CD and Super Video CD
- WMA discs
- DivX Plus HD discs
- HD DVD

■ Region management information

BD-Video

This unit can play BD-Video discs supporting the region code "B".

Example:



DVD-Video

This unit can play DVD-Video discs supporting the region number "2" or "ALL".

Example:



■ Finalize

DVD-R/RW/R DL, +R/+RW/+R DL and CD-R/RW recorded by a recorder, etc. needs to be finalized by the recorder to play on this unit. Please refer to the recorder's instructions.

■ BD-Video

This unit supports high bit rate audio (Dolby® Digital Plus, Dolby® TrueHD, DTS-HD High Resolution Audio and DTS-HD Master Audio) adopted in BD-Video.

■ 3D

- 3D videos and 3D still pictures can be played back when this unit is connected to a 3D compatible TV using a High Speed HDMI Cable.
- 2D video can be enjoyed as 3D virtually. (⇒ 31)

■ Music CD

Operation and sound quality of CDs that do not conform to CD-DA specifications (copy control CDs, etc.) cannot be guaranteed.

■ SD card

- miniSD Cards, microSD Cards, microSDHC Cards and microSDXC Cards can be used, but must be used with an adaptor card. These are usually supplied with such cards, or otherwise customer provided.
- To protect the card's contents, move the record prevention tab (on the SD card) to "LOCK".
- This unit is compatible with SD Memory Cards that meet SD Card Specifications FAT12 and FAT16 formats, as well as SDHC Memory Cards in FAT32 format and SDXC Memory Cards in exFAT.
- If the SD card is used with incompatible computers or devices, recorded contents may be erased due to the card being formatted etc.
- Usable memory may be slightly less than the card capacity.



■ USB device

- This unit does not guarantee connection with all USB devices.
- This unit does not support USB device charging.
- FAT12, FAT16, FAT32, and NTFS file systems are supported.
- This unit supports USB2.0 High Speed.
- This unit can support an HDD formatted to FAT32 and NTFS. Some types of HDD may require the use of its external power supply unit.

■ BD-RE, BD-R

Discs recorded in DR mode using Panasonic Blu-ray Disc recorders may not play back the audio etc., correctly.



- It may not be possible to play the above media in some cases due to the type of media, the condition of the recording, the recording method, and how the files were created.
- The producers of the disc can control how discs are played, so you may not always be able to control play as described in these operating instructions. Read the disc's instructions carefully.

Control reference guide

Remote Control

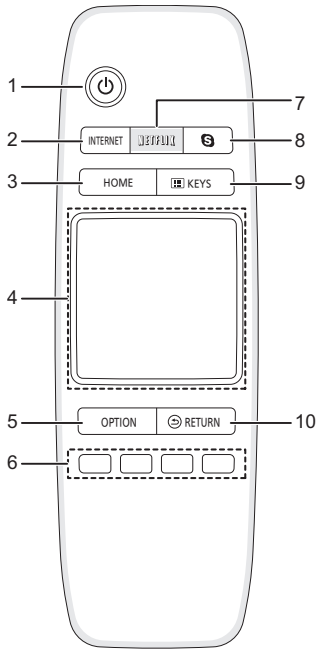

- 1 Turn the unit on and off
- 2 Show the Home screen of the VIERA Connect (⇒ 25)
- 3 Show HOME menu (⇒ 19)
- 4 Touchpad (⇒ 10)
Used for various operation
Move the highlight, confirm the selection, etc.
- 5 Show Option menu (⇒ 29)
- 6 Coloured buttons (red, green, yellow, blue)
Used for various purposes depending on the display
- 7 Show NETFLIX screen (⇒ 25)
- 8 Start up a video communication (⇒ 25)
- 9 Show KEYS screen on the screen (⇒ 11)
- 10 Return to previous screen

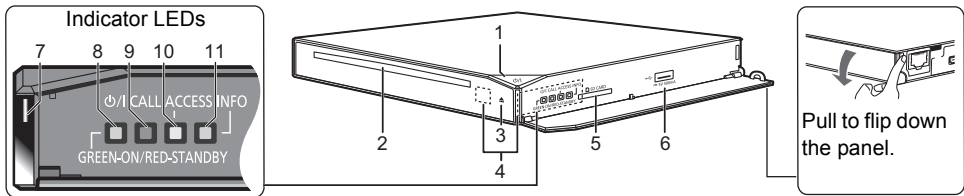

- 1 **Standby/on switch*** (⏻/⏻) (⇒ 16)
Touch to switch the unit from on to standby mode or vice versa. In standby mode, the unit is still consuming a small amount of power.
- 2 Disc slot (⇒ 19)
- 3 Eject the disc* (⇒ 19)
- 4 Remote control signal sensor
One of the two sensors will operate depending on the installation method of the main unit. (⇒ 12)
Distance: Within approx. 7 m
Angle (Against front of the sensor):
Approx. 20° up and down, 30° left and right
- 5 SD card slot (⇒ 19)
- 6 USB port (⇒ 19)
- 7 Status LED (blue/red)
 - This will light up in blue when the unit is turned on.
 - Blue and red will light up simultaneously when an error occurs. (⇒ 38)
 - This will flash in blue when this unit receives incoming call etc. of the video communication. (⇒ 25)
- 8 Standby/on LED (red/green)
When the unit is connected to the AC mains supply, this indicator lights red in standby mode and lights green when the unit is turned on. It is also possible to set to turn off when the unit is in standby mode. (⇒ 37, "Standby LED")
- 9 CALL LED (blue)
The LED will light up when this unit receives incoming call etc. of the video communication. (⇒ 25)
- 10 ACCESS LED (amber)
This will flash while accessing the SD card or USB device.
- 11 INFO LED (red)
This will light up at the time of error, etc. (⇒ 38)

* These switches work just by touching the marks. Be careful not to touch them unintentionally.
The volume of operation sound can be adjusted by "Unit Operation Volume". (⇒ 37)

Using the touchpad

The touchpad of the remote control is used for various operations such as moving the highlight or pointer, confirming the selection, playback control, entering characters, etc.

Basic touchpad operation

Move the highlight or the pointer

While touching the touchpad, the highlight or pointer will move according to the movement of your finger.

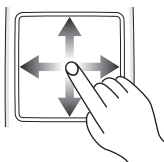

e.g.,

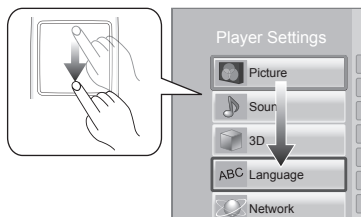

You can move the highlight continuously to up, down, left and right, by touching and holding an edge of the touchpad.

- It may not work depending on the screen.

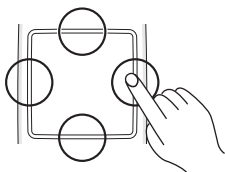

Confirm the selection

Tap the touchpad to confirm the selection. Release your finger as soon as it touches the touchpad.

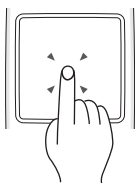

Switching the screen

Some screens can be switched by lightly flicking your finger horizontally or vertically on the touchpad.

Flick your finger quickly and release from the touchpad.



e.g.,

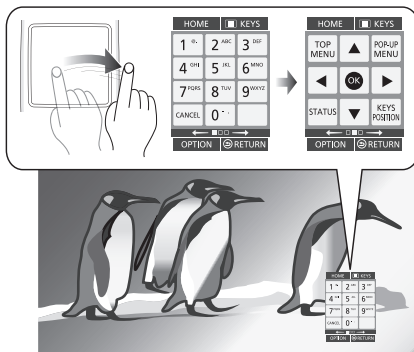

Bad example of flicking

Finger stops on the touchpad

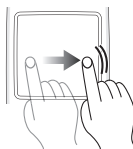

Movement is too slow

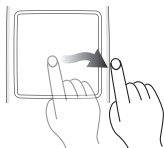

- It may not operate correctly in following cases:
 - Operation with your fingernails
 - Operation wearing gloves
 - Operation with wet hand
- Do not press the touchpad with pointed objects such as ballpoint pen, etc., or press with excessive force.

Using the KEYS screen

The KEYS screen that can perform item selection, playback control, text input, etc., is displayed on the screen when [KEYS] is pressed. KESY screen operation will take priority over all other operation on the screen.

- 1 Select the screen to operate by pressing on [KEYS] several times.
(⇒ below, Types of KEYS screen)
 - Screen can also be switched by flicking horizontally.
- 2 Move the pointer onto the key to select.

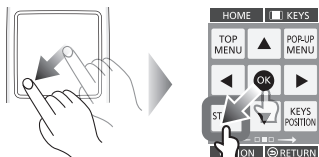

- 3 Release your finger and then tap.

To hide the KEYS screen

Press [RETURN].

Types of KEYS screen

Following screens switch in turn each time [KEYS] is pressed.

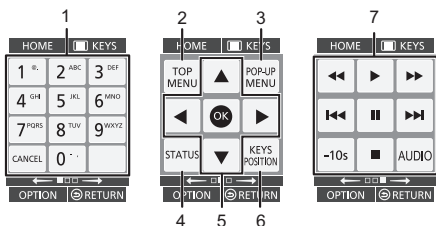

- 1 Select title numbers, etc./Enter numbers or characters
- 2 Show Top menu (⇒ 22)
- 3 Show Pop-up menu (⇒ 22)
- 4 Show status messages (⇒ 22)
- 5 [▲, ▼, ◀, ▶]: Move the highlight for selection
[OK]: Confirm the selection
- 6 Change the display position of the KEYS screen. The position switches each time the key is selected.

- 7 Basic playback control buttons (⇒ 21)

- [HOME], [KEYS], [OPTION] and [RETURN] indications are only for guidance purpose. Selection of these keys is not possible on the KEYS screen.

Entering characters

- 1 When the keyboard screen appears:
Move the highlight or the pointer onto "Input Mode", then tap.

You can select the input method from two types as follows. The mode switches each time "Input Mode" is selected.

Mode 1:

The highlight moves vertically or horizontally as your finger moves on the touchpad.



Mode 2:

The pointer moves freely according to the movement of your finger.

Select to move the cursor in the text box



- 2 Move the highlight or the pointer onto a key, then tap.

STEP 1 : Installing the Unit

The unit can be installed in following four ways.

- Use the pedestal supplied with the unit.
- Beware of tipping or falling of the main unit when connecting the cables after installation.
- The remote control signal sensor that will operate will change depending on the installation, so please note this when pointing the remote control at the unit.

Horizontal diagonal installation with pedestal

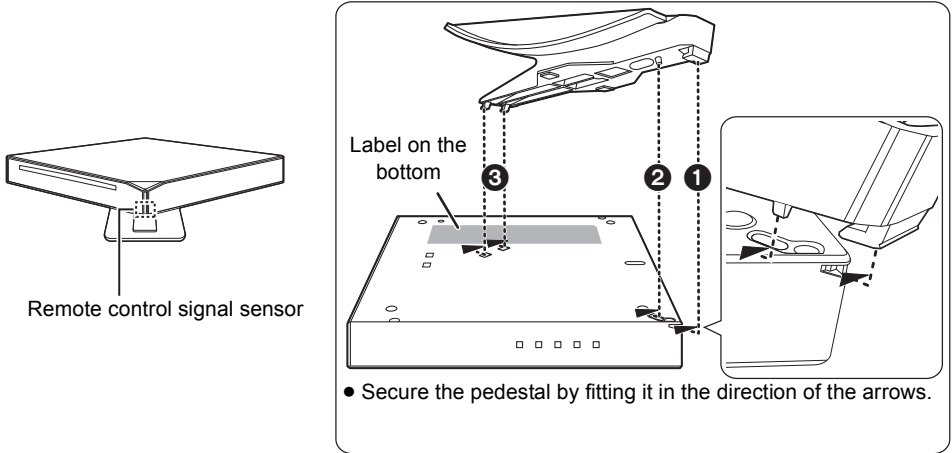

Horizontal installation with pedestal

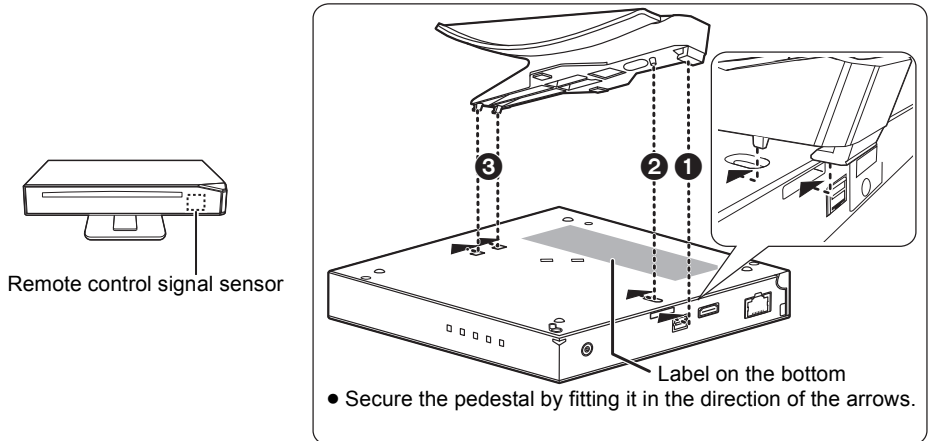

Horizontal installation with no pedestal



Vertical installation with pedestal

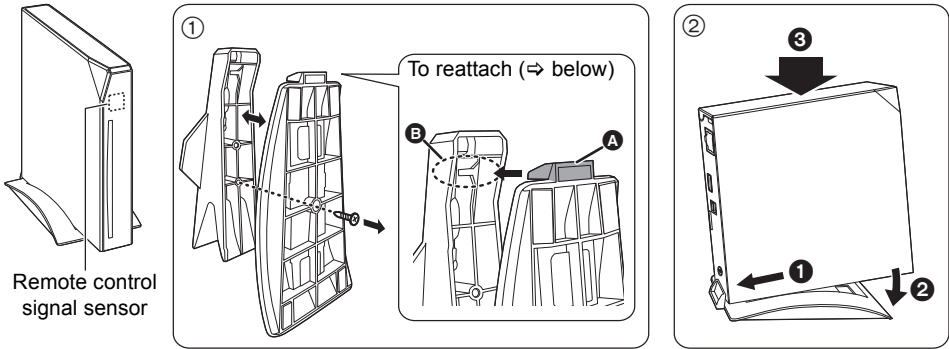

- ① Remove the screw at the bottom of the supplied pedestal using a screwdriver (+), and separate the top section and the bottom section of the pedestal. Top section of the pedestal is not used.
- ② Align the rear end of the main unit against the rear end of the pedestal, and lower the main unit. Press and secure the main unit into the pedestal.

To reattach the pedestal

Fit the projecting part (A) into the groove (B). Secure the two sections with the screw.



- Do not install in a way other than described above. Also, do not move the unit during playback. It may cause malfunction of the unit or damage the disc.
- Do not hold the pedestal to lift up or carry the unit.

STEP 2 : Connecting to a TV

- Before making any connections, we recommend that you temporarily disconnect all the units from AC power.
- Use the High Speed HDMI cables. Non-HDMI-compliant cables cannot be utilized. The HDMI-compliant cable is supplied with this unit. It is recommended that you use Panasonic's HDMI cable. When outputting 1080p signal, please use HDMI cables 5.0 meters or less. Recommended part number (High Speed HDMI Cable): RP-CDHS15 (1.5 m), RP-CDHS30 (3.0 m), RP-CDHS50 (5.0 m), etc.

BE SURE TO READ THE CAUTION FOR THE AC MAINS LEAD ON PAGE 3 BEFORE CONNECTION.

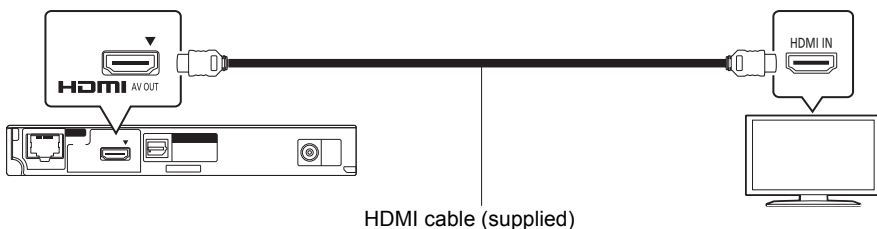

STEP 3 : Connecting to an amplifier/receiver

Perform either one of the following connections in accordance with your amplifier/receiver input terminal.

HDMI AV OUT

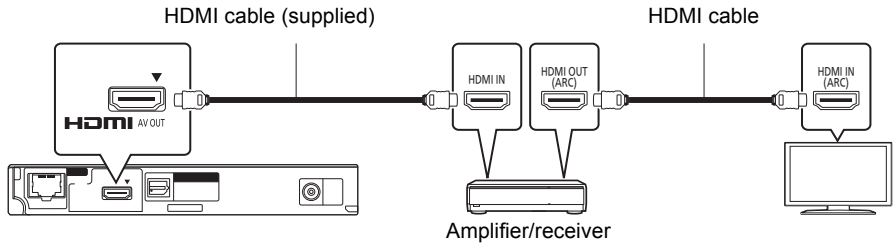

- Set "Digital Audio Output" (⇒ 33).
- When connecting to a non-3D compatible amplifier/receiver, connect this unit to a TV via HDMI AV OUT, then connect the TV and the amplifier/receiver. Please note, however, that the audio can only be up to 5.1ch.
- When using the TV or amplifier/receiver that does not have the indication of "(ARC)" (non-ARC-compatible) on the HDMI terminal, in order to enjoy TV's sound by amplifier/receiver it is also required to connect the amplifier/receiver and TV using an optical digital cable.

DIGITAL AUDIO OUT (OPTICAL)

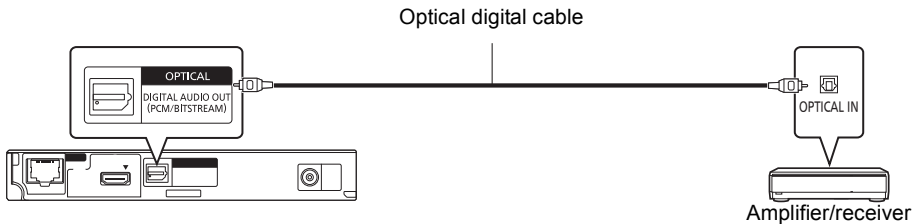

- Set "HDMI Audio Output" to "Off" (⇒ 33).
- Set "Digital Audio Output" (⇒ 33).

STEP 4 : Connecting to the network

The following services can be used when this unit is connected to broadband.

- Firmware can be updated (⇒ 18)
- You can enjoy BD-Live (⇒ 23)
- You can enjoy VIERA Connect (⇒ 25)
- You can access other devices (Home Network) (⇒ 26)
- This unit supports Wi-Fi Direct™ and can make a wireless connection to wireless devices without router. You can use this function when enjoying Home Network feature, etc. Internet access is not available while connected via Wi-Fi Direct™. (⇒ 26, 35)

For details about connection method, refer to the instructions supplied with the connected equipment.

Wireless LAN connection

This unit can be connected to a wireless router wirelessly.



- For up-to-date compatibility information on your wireless router, refer to <http://panasonic.jp/support/global/cs/> (This site is in English only.)
- The unit is not compatible with public wireless LAN services (Hotspot etc.) provided in airports, stations, cafes, etc.
- See page 45 for the precautions for wireless LAN connection.

LAN cable connection

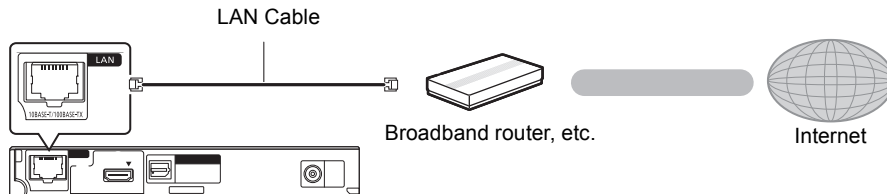

- Use category 5 or above straight LAN cables (STP) when connecting to peripheral devices.
- Inserting any cable other than a LAN cable in the LAN terminal can damage the unit.

STEP 5 : Connecting the AC mains lead

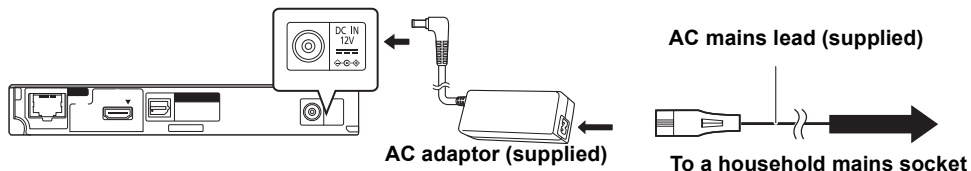

- This unit consumes a small amount of AC power (⇒ 44) even when turned off. In the interest of power conservation, if you are not planning to use the unit for an extended period of time, please disconnect the AC mains lead from the household mains socket.
- The unit is in the standby condition (Standby/on LED lights red) (⇒ 9) when the AC mains lead is connected. The primary circuit is always “live” as long as the AC adaptor is connected to an electrical outlet.
- Do not use any other AC adaptors except the supplied one.

STEP 6 : Settings

Easy Setting

After connecting your new player for the first time and pressing [⏻], a screen for the basic settings will appear.

Preparation

Turn on the television and select the appropriate video input on the television.

1 Press [⏻].

Please wait until the Status LED lights blue.
Setup screen appears.

2 Follow the on-screen instructions and apply the settings.



- You can perform this setup anytime by selecting "Easy Setting" in the Setup menu. (→ 36)
- If this unit is connected to a Panasonic TV (VIERA) supporting HDAVI Control 2 or later via an HDMI cable, then setting information on the TV such as "On-Screen Language" is acquired by this unit.

Easy Network Setting

After completing "Easy Setting", you can perform "Easy Network Setting".

Select "Wired" or "Wireless".

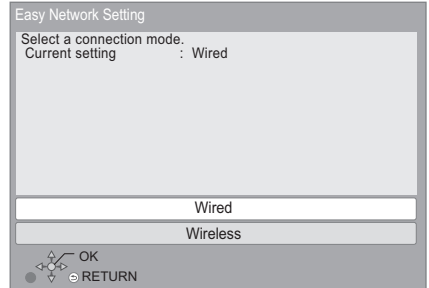

■ "Wired" connection

Follow the on-screen instructions to apply your connection settings.

■ "Wireless" connection

Before beginning wireless connection setup

- Obtain your network name (SSID*).
- If your wireless connection is encrypted, please be sure that you know your encryption key.

Select "Search for wireless network" or "WPS (PUSH button)", then follow the on-screen instructions and apply the settings.

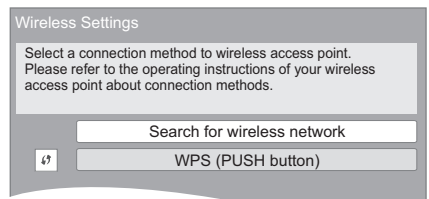

WPS (PUSH button):

If your wireless router supports WPS (PUSH button), you can easily perform the settings by pressing WPS button on it.

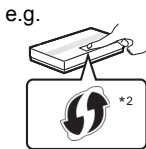

WPS (Wi-Fi Protected Setup™) is a standard that facilitates settings relating to the connection and security of wireless LAN devices.

- ① Press WPS button or corresponding button of the wireless router until the lamp starts flashing.
 - For details, refer to the operating instruction of the wireless router.
- ② Select "Start".

Search for wireless network:

- When you select "Search for wireless network", the available wireless networks will be displayed. Select your network name.
 - If your network name is not displayed, search again by pressing the red button on the remote control.
 - Stealth SSID will not be displayed when you select "Search for wireless network". Enter manually by using "Manual setting".
(Press [HOME] ⇒ select "Setup" ⇒ select "Player Settings" ⇒ select "Network" ⇒ select "Network Settings" ⇒ select "Wireless Settings" ⇒ select "Connection Setting" ⇒ select "Manual setting")
- If your wireless network is encrypted, Encryption Key input screen will be displayed. Input the encryption key of your network.



- Refer to the operating instructions of the hub or router.
- You can perform this setup anytime by selecting "Easy Network Setting" in the Setup menu. (⇒ 35)
- You can redo these settings individually using "Network Settings". (⇒ 35)
- Do not use this unit to connect to any wireless network for which you do not have usage rights.
During automatic searches in a wireless network environment, wireless networks (SSID) for which you do not have usage rights may be displayed; however, using these networks may be regarded as illegal access.
- After performing network settings on this unit, the settings (encryption level, etc.) of the wireless router might change. When you have trouble getting online on your PC, perform the network settings on your PC in accordance with the settings of the wireless router.
- Please be aware that connecting to a network without encryption may result in the content of the communication being illegitimately viewed by a third party, or the leaking of data such as personal or secret information.

*1 An SSID (Service Set IDentification) is a name used by wireless LAN to identify a particular network. Transmission is possible if the SSID matches for both devices.

*2 The wireless router compatible with Wi-Fi Protected Setup™ may have the mark.

Firmware updates

Occasionally, Panasonic may release updated firmware for this unit that may add or improve the way a feature operates. These updates are available free of charge.

This unit is capable of checking the firmware automatically when connected to the Internet via a broadband connection.

When a new firmware version is available, the following message is displayed.

New firmware is available.
Please update firmware in Setup.

To update the firmware

Press [HOME] ⇒ select "Setup" ⇒ select "Player Settings" ⇒ select "System" ⇒ select "Firmware Update" ⇒ select "Update Now"

ACCESS LED will light up while downloading the firmware. The unit cannot be operated until the ACCESS LED is turned off.

DO NOT DISCONNECT the unit from the AC power or perform any operation while the update takes place.

After the firmware is installed, the unit will restart and the following screen will be displayed.



- If downloading on this unit fails or this unit is not connected to the Internet, then you can download the latest firmware from the following website and burn it to a CD-R to update the firmware.
<http://panasonic.jp/support/global/cs/>
(This site is in English only.)
To show the firmware version on this unit. (⇒ 37, "Firmware Version Information")
- Downloading will require several minutes. It may take longer or may not work properly depending on the connection environment.
- If you do not want to check for the latest firmware version, set "Automatic Update Check" to "Off". (⇒ 37)

STEP 7 : Reprogramming the remote control

If you have more than one Panasonic player/recorder and the remote control operates both products at once, you will need to change the remote control code to prevent this occurrence. (⇒ 37, "Remote Control")

Inserting or removing media

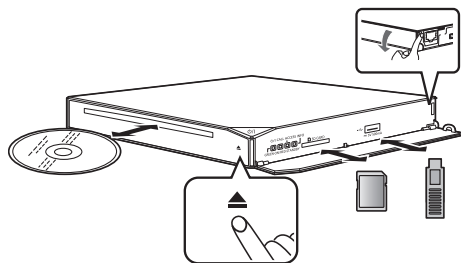

Inserting disc in the disc slot

- The disc will be pulled in when inserted partially.
- The power will be turned on automatically when the disc is inserted while in the standby mode.

To eject the disc

Touch [▲].

- Remove the disc with your hands once the disc is ejected partially. If the disc is not removed, the unit will pull in the disc for safety reasons. In this case, playback does not start automatically.

Notes

- When inserting a media item, ensure that it is facing the right way up.
e.g., When installed vertically

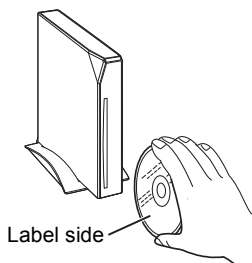

- To insert a disc that was ejected partially, do not force the disc back in, but re-insert it after removing the disc completely.
- Do not leave a disc that is partially ejected. It is recommended to completely take out the disc from this unit if the disc is not going to be used.
- When removing the SD card, press the centre of the card and pull it straight out.
- If you connect a Panasonic product with a USB connection cable, the setup screen may be displayed on the connected equipment. For details, refer to the instructions for the connected equipment.

HOME menu

Major functions of this unit can be operated from the HOME menu.

Preparation

Turn on the television and select the appropriate video input on the television.

- 1 Press [ON] to turn on the unit.
- 2 Operate the touchpad to select the item.
Tap to select the centred item.
Swipe or flick your finger up, down, left, or right to select other items.
• If there are any other items, repeat this step.

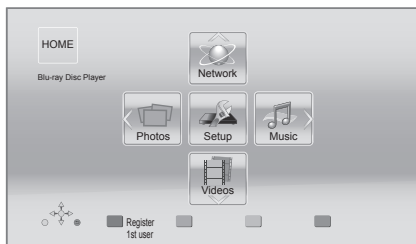

Videos/Photos/Music

Disc	Play back the contents. (⇒ 21)
SD Card	• When multiple contents are recorded, select the types of contents or the title.
USB	

Network

Network Service	Displays the Home screen of VIERA Connect. (⇒ 25)
Home Network	DLNA Client (⇒ 26)
	Media Renderer (⇒ 27)

Setup

Player Settings	(⇒ 22)
SD Card Management	(⇒ 23)
Wallpaper	Changes the background of HOME menu.

To show the HOME menu

Press [HOME].



- Items to be displayed may vary with the media.

Multi User Mode

Multi User Mode is a function that enables switching of multiple settings easily. Up to 4 people can use the unit with their own settings.

The following settings can be personalized.

- The user icon
- The wallpaper of HOME menu
- The audio and picture settings (⇒ 29, 32)

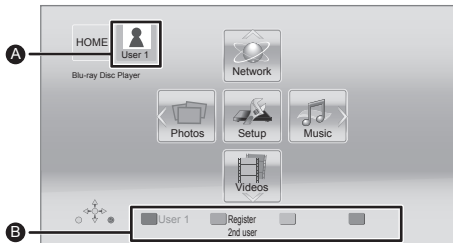

- A** The user name and icon currently selected
- B** Personalize a new user and switch the users with coloured buttons.

Personalizing a new user

- 1 Press [HOME].
- 2 Press a coloured button that indicates new user personalization.
- 3 Select an item and change the settings according to the indications.

The following items can be set.

Input Nickname	Personalize a user name.
Select Icon	<p>Personalize a user icon.</p> <p>Select from Illustrations The image can be selected from prepared illustrations.</p> <p>Create from Photos If the Communication Camera is connected, you can shoot and personalize your photo.</p> <ul style="list-style-type: none"> • You can also select a photo in recording media as an icon. (⇒ 29, "Icon Registration")
Select Wallpaper	<p>Personalize a background of the HOME menu.</p> <ul style="list-style-type: none"> • Other than prepared wallpapers, you can also select a photo in recording media as a wallpaper. (⇒ 29, "Wallpaper")

Register Smartphone

Smartphone used as a remote control can be registered with respect to each user.

- Multiple users cannot be registered for one smartphone.

4 Select "Confirm".

To change the personalized user information

Select "Edit User Information" from Setup menu. (⇒ 37)

Switching the user

There are three ways to switch the user as follows.

■ Using coloured buttons

Press the coloured buttons in the HOME menu to switch to the user corresponding to the button.

■ Using facial recognition

(Only when connected to Communication Camera ⇒ 25)

This is a function for fun using the Communication Camera and enables user switching by facial recognition. Perform "Create from Photos" (⇒ left) to personalize your facial photo before using this function.

1 Press [OPTION] in the HOME menu and select "Facial Recognition".

2 Turn the face to Communication Camera.

The camera captures your face and determines the closest face from the personalized user photos, and then displays the results.

- Accuracy of the recognition may be reduced depending on the captured image.

3 Follow the indications on the screen.

- To redo the facial recognition, press [RETURN].

■ Using registered smartphones

When the unit is turned on using the registered smartphone, the user who registered the smartphone will automatically be selected.

- Perform the "Remote Device Settings". (⇒ 35)



- To use smartphones as a remote control, installation of dedicated software is required. For more details, refer to the following website.
<http://panasonic.jp/support/global/cs/>
(This site is in English only.)

Playback

1 Insert the media.

Playback starts depending on the media.

2 Select the item to play.

Repeat this procedure if necessary.



- DISCS CONTINUE TO ROTATE WHILE MENUS ARE DISPLAYED. Select [■] from the KEYS screen when you have finished playback to protect the unit's motor, your television screen and so on.
- DivX and MKV: Successive play is not possible.
- It is not possible to play back AVCHD and MPEG2 videos which have been dragged and dropped or copied and pasted to the media.
- To save on electricity, the unit is turned off automatically if there is no button operation for about 30 minutes when not playing back (such as when paused, displaying the menu, displaying still pictures, etc.).

Operations during playback

1 Repeatedly press [KEYS] to display the playback control screen.

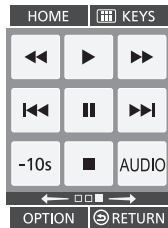

2 Select a key.

See page 11 for the KEYS screen operation. The following functions may not work depending on the media and contents.



The stopped position is memorized.

Resume play function

Select [▶] (PLAY) to restart from this position.

- The position is cleared if the disc is ejected or you select [■] several times to display the HOME menu.
- On BD-Video discs including BD-J, the resume play function does not work.



Select [||] again or [▶] (PLAY) to restart play.

Frame-by-frame

- ① While paused, repeatedly press [KEYS] to display the cursor key screen.
 - ② Select [◀] or [▶].
- Select [▶] (PLAY) to revert to normal playback speed.
 - BD-Video and AVCHD: [▶] only.



Search

While playing, select [◀◀] or [▶▶].

- Music and MP3: The speed is fixed to a single step.

Slow motion

While paused, select [◀◀] or [▶▶].

- BD-Video and AVCHD: [▶▶] only.

The speed increases up to 5 steps.

- Select [▶] (PLAY) to revert to normal playback speed.



Skip to the title, chapter or track.

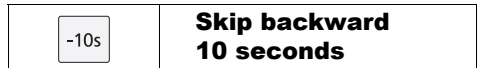

It will play back after skipping backward approximately 10 seconds every time the key is selected.





You can change the audio channel number or soundtrack language, etc.

Quick playback control

Basic operation can be performed by swiping the edge of the touchpad with your finger, such as the following.

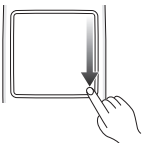
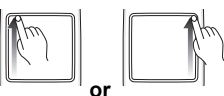
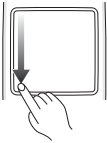
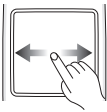
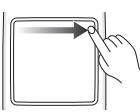
- Perform the operation when the KEYS screen is not displayed.

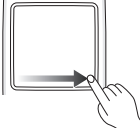
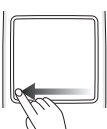
	Stop
	Play
	Pause
	Frame-by-frame (during pause) Forward: Swipe your finger from left to right. Backward: Swipe your finger from right to left.
	Search forward
	Search backward
	Skip forward
	Skip backward

Displaying menus and playback information

- 1 Repeatedly press [KEYS] to display the cursor key input screen.

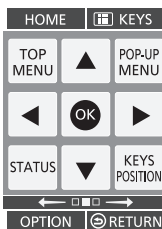

- 2 Select a key.

See page 11 for the KEYS screen operation.

The following functions may not work depending on the media and contents.

	Show top menu/ pop-up menu
---	---------------------------------------

Select the item.

	Show the status messages
---	-------------------------------------

The status messages give you information about what is currently being played. Each time you select [STATUS], the display information may change or will disappear from the screen.

- Depending on media and contents, the display may change or may not appear.

e.g., BD-Video

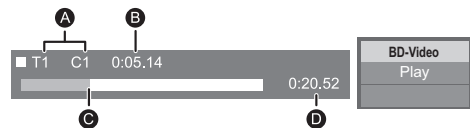

- A** T: Title, C: Chapter, PL: Playlist
- B** Elapsed time in the title
- C** Current position
- D** Total time

e.g., JPEG

Date	11.12.2007	1 / 26
Size	500 x 375	
Manufacturer		
Equipment		

Enjoying 3D video and photos

Preparation

Connect this unit to a 3D compatible TV.

(⇒ 13, 14)

- Perform the necessary preparations for the TV.
- Play back following the instructions displayed on the screen.
- 3D Settings (⇒ 31, 34)



- Please refrain from viewing 3D images if you do not feel well or are experiencing visual fatigue. In the event that you experience dizziness, nausea, or other discomfort while viewing 3D images, discontinue use and rest your eyes.
- 3D video might not output the way it is set in "HDMI Video Format" or "24p Output" (⇒ 32).
- When playing back 3D photos from "Photos" screen, select from the "3D" list. (Still pictures in "2D" are played back in 2D.) If "2D" and "3D" indications are not displayed, press the red button to switch the view of playback contents.

Enjoying BD-Live

With "BD-Live" discs, you can enjoy bonus contents that use Internet access.

For this BD-Live function, insertion of an SD card is necessary along with Internet connection.

1 Perform network connection and settings.
(⇒ 15, 16)

2 Insert an SD card with 1 GB or more free space.

- The SD card is used as the local storage.

3 Insert the disc.

■ Deleting data/Formatting SD cards

Select "SD Card Management" in the HOME menu (⇒ 19), then select "BD-Video Data Erase" or "Format SD Card".



- The usable functions and the operating method may vary with each disc, please refer to the instructions on the disc and/or visit their website.
- "BD-Live Internet Access" may need to be changed for certain discs (⇒ 36).

Slideshow

Play a slideshow of photos and make various settings during the playback.

- 1 Insert the media.
- 2 Select "Photos".
- 3 Select an item and press the green button.

The following items can be set.

Start Slideshow	Start the slideshow. You can display still pictures in the selected folder one by one at a constant interval.
Interval	Change the display interval.
Transition Effect	Select the effect when sliding pictures.
Repeat Play	Set whether to repeat the slideshow.
Soundtrack	Set whether to play background music. <ul style="list-style-type: none">• FLAC, MP3 and WAV on the USB device can be played back during the slideshow of JPEG on the USB device or the SD card.• A music CD can also be played back during the slideshow of JPEG on the SD card.
Soundtrack Folder	Select the folder from which the music files are played.
Random Soundtrack	Background music is played in random order.



- Still pictures displayed as "  " cannot be played back with this unit.
- When both the music CD and the USB device with recorded music are inserted into this unit, the music CD has priority to be played back as background music.

VIERA Connect (Enjoying Internet Service)

VIERA Connect allows you to access some specific websites supported by Panasonic, and enjoy Internet contents such as photos, videos, etc. from VIERA Connect Home screen. This unit has no full browser function and all features of websites may not be available.

VIERA Connect provides a variety of selected Internet services such as the following.

- Online movie rental service
- Video communication service
- Video browsing service

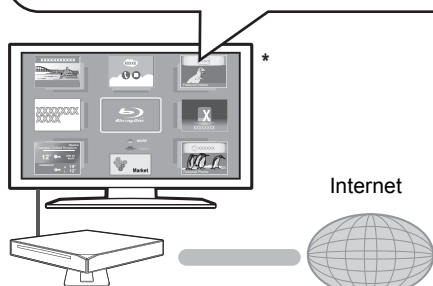

* Images are for illustration purposes, contents may change without notice.

Preparation

- Network connection (⇒ 15)
- Network setting (⇒ 16)

To enjoy video communication (e.g. Skype™) :

- Connect this unit with optional Communication Camera (TY-CC20W or TY-CC10W). Depending on your location, this optional camera may not be available. Please consult your local Panasonic dealer for advice.

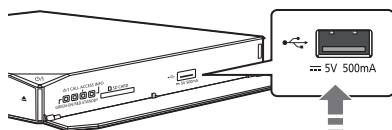

Communication Camera
TY-CC20W or TY-CC10W

1 Press [INTERNET].

- The video communication service can be accessed directly by pressing [**S**] button, and NETFLIX can be accessed directly by pressing [NETFLIX] button.

2 Select the item.

To exit from VIERA Connect

Press [HOME].



- When playing content in the media, VIERA Connect cannot be accessed by pressing [INTERNET].
- In the following cases, settings are possible using the Setup menu items.
 - When restricting the use of VIERA Connect (⇒ 36, "Network Service Lock")
 - When the audio is distorted (⇒ 35, "Audio Auto Gain Control")
 - When wrong time is displayed (⇒ 35, "Time Zone", "Summer Time")
- If using slow Internet connection, the video may not be displayed correctly. A high speed Internet service with a speed of at least 6 Mbps is recommended.
- Be sure to update the firmware when a firmware update notice is displayed on the screen. If the firmware is not updated, you will not be able to use the VIERA Connect function. (⇒ 18)
- VIERA Connect Home screen is subject to change without notice.
- The services through VIERA Connect are operated by their respective service providers, and service may be discontinued either temporarily or permanently without notice. Therefore, Panasonic will make no warranty for the content or the continuity of the services.
- All features of websites or content of the service may not be available.
- Some content may be inappropriate for some viewers.
- Some content may only be available for specific countries and may be presented in specific languages.

Home Network feature

Playing back contents on the DLNA server

You can share photos, videos and music stored in the DLNA Certified media server (PC with Windows 7 installed, smartphone, etc.) connected to your home network, and enjoy the contents with this player.

You can also enjoy viewing the video and photos recorded in Panasonic DLNA compatible recorders (DIGA).

Refer to our website about the sales area, etc. (⇒ 27)

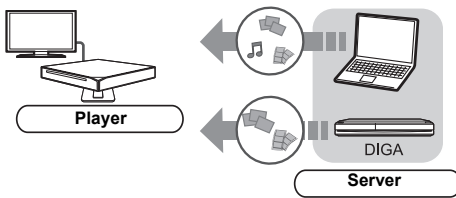

Preparation

- ① Perform network connection (⇒ 15) and network settings (⇒ 16) of this unit.
- ② Perform Home Network settings of the connected equipment.

When connected to other than DIGA,

- ③ Add the contents and folder to the libraries of the Windows Media® Player or the smartphone, etc.
 - Playlist of Windows Media® Player can play back only the contents that are stored in the libraries.

When connected to DIGA,

- ③ Register this unit to your DIGA.

- 1 Press [HOME].
- 2 Select “Network”.
- 3 Select “Home Network”.
- 4 Select “DLNA Client”.
 - The list can be updated by pressing the red button on the remote control.
 - The connection method can be switched to Wi-Fi Direct by pressing the green button on the remote control.
- 5 Select the equipment.
- 6 Select the item to play.
 - You may be able to use convenient functions depending on the content by pressing [OPTION].
 - Control Panel (⇒ 30) is displayed once the playback starts. Tap the touchpad if the Control Panel is not displayed, and press [RETURN] to hide the Control Panel.

To exit from Home Network

Press [HOME].

Using the Digital Media Controller

You can use the smartphone, etc. as the Digital Media Controller (DMC) to play back contents from DLNA server on the Renderer (this unit).

Possible applications:

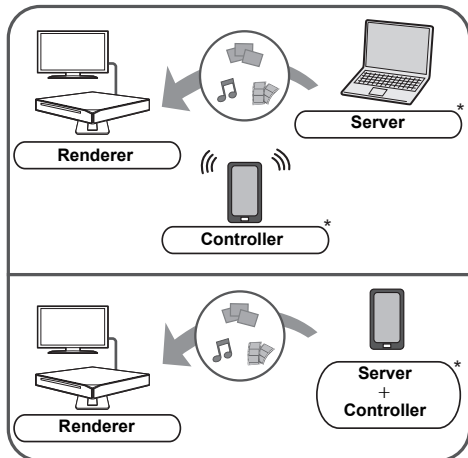

* DMC compatible software should be installed.

Preparation

Perform steps ① and ②. (⇒ 26)

- ③ Add the contents and folder to the libraries of the Windows Media® Player or the smartphone, etc.
 - Playlist of Windows Media® Player can play back only the contents that are stored in the libraries.
- ④ Perform the “Remote Device Settings”. (⇒ 35)
 - You can register up to 16 devices.

- 1** Press [HOME].
- 2** Select “Network”.
- 3** Select “Home Network”.
- 4** Select “Media Renderer”.
- 5** Select “Home Network” or “Wi-Fi Direct”, then follow the indications on the screen.
- 6** Operate the DMC compatible devices.

To exit from Media Renderer screen

Press [HOME].



For more details, refer to the following website and the operating instructions for each of the equipment.
<http://panasonic.jp/support/global/cs/>
(This site is in English only.)

- Wi-Fi Direct connection while using Home Network feature is only temporary, and the network connection method returns to the original setting when exiting.
- Depending on the contents and the connected equipment, playback may not be possible.
- Items displayed in grey on the display cannot be played back by this unit.
- This unit can be played back via connected equipment only when controlled using DMC.

VIERA Link “HDAVI Control”™

What is VIERA Link “HDAVI Control”?

VIERA Link “HDAVI Control” is a convenient function which will link the operations of this unit and a Panasonic TV (VIERA) or other device under “HDAVI Control”.

You can use this function by connecting the equipment with an HDMI cable. See the operating instructions for connected equipment for operational details.

Preparation

- ① Set “VIERA Link” to “On” (⇒ 37).
(The default setting is “On”.)
- ② Set the “HDAVI Control” operations on the connected equipment (e.g., TV).
- ③ Turn on all “HDAVI Control” compatible equipment and select this unit’s input channel on the connected TV so that the “HDAVI Control” function works properly.

Also, when the connection or settings are changed, repeat this procedure.

Automatic input switching Power on link

When the following operations are performed, the input channel of the television will be automatically switched and the screen of this unit will be displayed.

When the television is off, the television will automatically turn on.

- When play starts on the unit
- When an action that uses the display screen is performed
(e.g., HOME menu)

Power off link

All connected equipment compatible with “HDAVI Control”, including this unit, automatically turns off when you switch the television off.

Playing music continuously even after turning off the television

When the unit is connected to a Panasonic TV (VIERA) that supports HDAVI Control 2 or later and an amplifier/receiver supports VIERA Link.

- ① While playing music
Press [OPTION].
- ② Select “TV Power”.

Easy control only with VIERA remote control

Only when TV supports “HDAVI Control 2” or later

By using the TV remote control, you can perform various playback operations and settings.

See the operating instructions of the TV for more details.



- The buttons that you can use for this unit vary depending on the TV. For details, refer to the operating instructions of the TV.
- The operation of this unit may be interrupted when you press certain buttons on the TV remote control.
- This unit supports “HDAVI Control 5” function.
“HDAVI Control 5” is the newest standard (current as of November, 2011) for Panasonic’s HDAVI Control compatible equipment. This standard is compatible with Panasonic’s conventional HDAVI equipment.
- VIERA Link “HDAVI Control”, based on the control functions provided by HDMI which is an industry standard known as HDMI CEC (Consumer Electronics Control), is a unique function that we have developed and added. As such, its operation with other manufacturers’ equipment that supports HDMI CEC cannot be guaranteed.
- Please refer to individual manuals for other manufacturers’ equipment supporting VIERA Link function.

Option menu

A variety of playback operations and settings can be performed from this menu.

Available options differ depending on the playing contents and the condition of the unit.

About Multi User Mode

 : Settings of the items with this indication are saved by the respective users registered in the HOME menu.

Please refer to page 20 for details about user registration and switching.

1 Press [OPTION].

- When playing music, select “Playback Settings”.

e.g., BD-Video

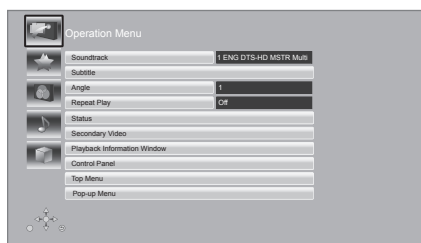

2 Select an item and change the settings.

To exit the screen

Press [OPTION].

Regarding Language : (⇒ 45)

Operation Menu

■ Soundtrack

Show or change the soundtrack.

■ Audio channel

Select the audio channel number.

■ Subtitle

Change the subtitle settings.

■ Angle

Select the number of the angle.

■ Repeat Play

Select the item that you want to repeat.

- The items displayed differ depending on the type of media.
- Select “Off” to cancel.

■ Random

Select whether or not to play random.

■ Start Slideshow

Start the slideshow.

■ Status

Show the status messages.

■ Rotate RIGHT

■ Rotate LEFT

Rotate the still picture.

■ Wallpaper

Set the still picture to the wallpaper of HOME menu. (⇒ 19)

■ Icon Registration

Set the still picture as your user icon. (⇒ 20)

■ Video



The recording method of original video appears.

■ Secondary Video

Video	Select on/off for images. The recording method of original video appears. <ul style="list-style-type: none">• During search/slow motion or frame-by-frame, only the primary video is displayed.
Soundtrack	Select on/off for audio and language.

■ Playback Information Window

Displays the following.

	Audio/video attribute information of disc.
	Settings status of “Digital Audio Output” (⇒ 33).
	HDMI output information.

Press [RETURN] to exit.

■ Control Panel

Display the Control Panel.

Playing back while using VIERA Link, etc.

e.g.,

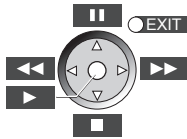

Tap to select the centre key.

Swipe your finger up, down, left, or right to select the keys accordingly.

Press [RETURN] to hide the Control Panel.

■ Top Menu

Display Top Menu.

■ Pop-up Menu

Display Pop-up Menu.

■ Menu

Display Menu.

Personal Taste

You can access settings to enjoy special features of this unit from this category.

Refer to “Picture Settings” and “Sound Settings” (⇒ 31) for more details on each setting item.

Picture Settings

■ Picture Mode

Select the picture quality mode during play.

- If you select “User”, you can change settings in “Picture Adjustment”.

■ Picture Adjustment

Specific picture quality settings can be performed.

- 3D NR:
Reduces the rough noise in the background to give a greater feeling of depth.
When “24p Output” is set to “On”, this function may not operate. (⇒ 32)
- Integrated NR:
Smooths block noise and reduces the smudging that appears around contrasting sections of the picture.

■ Chroma Process

The high resolution processing of HDMI chroma signals produces a high resolution picture with rich picture quality.

■ Detail Clarity

The picture is sharp and detailed.

■ Super Resolution

Pictures of normal image quality are corrected to sharp and detailed images when output as 1080i/1080p from HDMI AV OUT.

■ Progressive

Select the method of conversion for progressive output to suit the type of material being played.

- If the video is disrupted when “Auto” is selected, select either “Video” or “Film” depending on the material to be played back.

■ 24p

Movies and other material recorded on DVD-Video at 24p are output at 24p.

- Only when you have selected “On” in “24p Output” (⇒ 32) and play discs recorded at a rate of 60 fields per second.
- This may not work with the PAL contents.

■ Screen Aspect

Switch the screen mode.

■ Reset to Default Picture Settings

Return picture settings to the factory preset.

Sound Settings

■ Sound Effects^{*1,*2}

Select the sound effect.

● Night Surround :

Enjoy a movie with powerful sound even when the volume is kept low at night. The audio is set in such a way that it can be heard easily.

● Re-master :

This feature gives you brighter sound by increasing the high frequency portion of the audio. (Discs recorded at 48 kHz or less)

Recommended setting

Re-master 1	Pop and rock
Re-master 2	Jazz
Re-master 3	Classical

● Digital Tube Sound :

This feature gives you a warm sound, like that produced by a vacuum tube amplifier.

Recommended setting

Digital Tube Sound 1	A crisp, delicate sound
Digital Tube Sound 2	A tight, hi-fi sound
Digital Tube Sound 3	A soft, rich sound
Digital Tube Sound 4	A clear, powerful sound
Digital Tube Sound 5	A distinctive mid-range sound
Digital Tube Sound 6	A soft, enveloping sound

■ Dialogue Enhancer^{*2}

The volume of the centre channel is raised to make dialog easier to hear.

■ High Clarity Sound Plus

When playing back music contents, it improves the sound quality by stopping the video output.

- When “No HDMI Output” is selected, the sound is output only from the DIGITAL AUDIO OUT.

^{*1} Not every function can be set individually.

^{*2} This function is effective for audio from HDMI AV OUT or DIGITAL AUDIO OUT only when “Digital Audio Output” is set to “PCM” (⇒ 33). (However, in this case, audio is output as 2ch from DIGITAL AUDIO OUT.)

3D Settings

■ Signal Format

Original	Keep original picture format.
Side by side	3D picture format comprising of left and right screens.
2D to 3D	Converts 2D pictures to 3D effect.

■ 3D Picture Mode

Normal	Play back pictures with normal 3D effects.
Soft	You can enjoy 3D pictures with a feeling of broadness, holding back the depth perception.
Manual	Play back 3D pictures with settings of “Manual Settings”.

■ Manual Settings

Distance	Set the amount of depth perception.
Screen Type	Selects how the screen appears during 3D playback (flat or round).
Frame Width	Set the amount of feathering at the edge of screen.
Frame Colour	Set the colour of feathering at the edge of screen.

■ Graphic Display Level

(Only when “Full HD” is selected in “3D Type” (⇒ 34).)

3D position for the Option menu or message screen, etc. can be adjusted during 3D playback.

Setup menu

Change the unit's settings if necessary. The settings remain intact even if you switch the unit to standby.

Some items in the Setup menu are common to the Option menu. You can get the same effect with both menus.

About Multi User Mode

 : Settings of the items with this indication are saved by the respective users registered in the HOME menu.

Please refer to page 20 for details about user registration and switching.

- 1 Press [HOME].
- 2 Select "Setup".
- 3 Select "Player Settings".

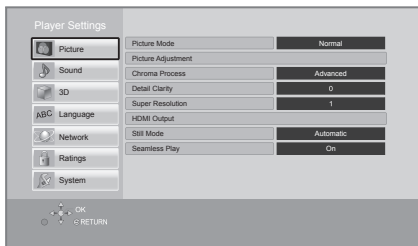

- 4 Select an item and change the settings.

To exit the screen

Press [HOME].

Picture

■ **Picture Mode**  (⇒ 30)

■ **Picture Adjustment**  (⇒ 30)

■ **Chroma Process**  (⇒ 30)

■ **Detail Clarity**  (⇒ 30)

■ **Super Resolution**  (⇒ 30)

■ HDMI Output

Tap to show the following settings:

> HDMI Video Format

The items supported by the connected devices are indicated on the screen as "✳". When any item without "✳" is selected, the images may be distorted.

- If "Automatic" is selected, the best suited output resolution to the connected television is automatically selected.
- To enjoy high-definition video up-converted to 1080p, you need to connect the unit directly to 1080p compatible HDTV (High Definition Television). If this unit is connected to an HDTV through other equipment, the other equipment must also be 1080p compatible.

> 24p Output

When this unit is connected to a TV supporting 1080/24p output using an HDMI cable, movies and other material recorded at 24p are output at 24p.

- When playing DVD-Video, set to "On" and then set "24p" in "Picture Settings" (⇒ 30) to "On".
- When BD-Video images other than 24p are played, images are output at 60p.
- 24p : A progressive image recorded at a rate of 24 frames per second (motion-picture film). Many BD-Video movie contents are recorded in 24 frames/second in accordance with the film materials.

> HDMI Colour Mode

This setting is for selecting colour-space conversion of the image signal when the unit is connected using an HDMI cable.

> Deep Colour Output

This setting is for selecting whether to use Deep Colour output when a television that supports Deep Colour is connected.

> Contents Type Flag

Depending on the playback content, the TV will output adjusting to the optimal method when a TV that supports this function is connected.

■ Still Mode

Select the type of picture shown when you pause playback.

Automatic	Automatically selects the type of picture shown.
Field	Select if jittering occurs when "Automatic" is selected.
Frame	Select if small text or fine patterns cannot be seen clearly when "Automatic" is selected.

■ Seamless Play

The chapter segments in playlists are played seamlessly.

- Select "On" when the picture freezes for a moment at the chapters segment in playlists.

Sound

■ Sound Effects (⇒ 31)

■ Dialogue Enhancer (⇒ 31)

■ Dynamic Range Compression

You can listen at low volumes but still hear dialog clearly.

(Dolby Digital, Dolby Digital Plus and Dolby TrueHD only)

- "Automatic" is effective only when playing Dolby TrueHD.

■ Digital Audio Output

Tap to show the following settings:

➤ Dolby D/Dolby D +/Dolby TrueHD

➤ DTS/DTS-HD

➤ MPEG Audio

Select the audio signal to output.

- Select "PCM", when the connected equipment cannot decode the respective audio format. This unit decodes the audio format and transmits to the connected equipment.
- Not making the proper settings may result in noise.

➤ BD-Video Secondary Audio

Select whether or not to mix the primary and secondary audio (including the button click sound).

If "Off" is selected, the unit outputs the primary audio only.

➤ HDMI Audio Output

This setting selects whether or not to output audio from HDMI.

- Select "Off" when the TV is connected to this unit via HDMI AV OUT, and this unit is also connected to other devices, such as an amplifier/receiver via DIGITAL AUDIO OUT.

■ PCM Down Conversion

Select how to output audio with a sampling frequency of 96 kHz for the PCM output from the DIGITAL AUDIO OUT.

- If "On" is selected, the signals that are converted to 48 kHz are output.
- If "Off" is selected, and the connected equipment does not support 96 kHz, the sound will not be output normally.
- Signals are converted to 48 kHz despite the settings in the following cases:
 - when the signals have a sampling frequency of 192 kHz
 - when the disc has copy protection
 - when "BD-Video Secondary Audio" is set to "On"

■ Downmix

Select the downmix system of multi-channel to 2-channel sound.

- Select "Surround encoded", when the connected equipment supports the virtual surround function.
- There is no effect on "Bitstream" via HDMI AV OUT and DIGITAL AUDIO OUT.
- The audio will be output in "Stereo" in the following cases:
 - AVCHD playback
 - Playback of secondary audio (including the button click sound).

■ 7.1ch Audio Reformatting

Surround sound with 6.1ch or less is automatically expanded and played back at 7.1ch.

- If “Off” is selected, sound is played over the original number of channels. (Note that in the case of 6.1ch audio, playback will be at 5.1ch.)
- Audio reformatting is enabled in the following cases:
 - When you have selected “PCM” in “Digital Audio Output”.
 - When the audio is Dolby Digital, Dolby Digital Plus, Dolby TrueHD or LPCM.
 - BD-Video playback

■ Audio Delay

Synchronization between picture and sound is corrected by adjusting the delay time of the audio output.

3D

■ 3D BD-Video Playback

Select the playback method of 3D compatible video software.

■ 3D AVCHD Output

Select the output method of 3D AVCHD videos.

■ 3D Type

Select the format of the connected TV.

- Change the settings for 3D on the TV also when “Side by side” is selected.

■ 3D Playback Message

Set to display or hide the 3D viewing warning screen when playing back the 3D compatible video software.

■ Manual Settings (⇒ 31)

■ Graphic Display Level (⇒ 31)

Language

■ Soundtrack Preference

Choose the language for audio.

- If “Original” is selected, the original language of each disc will be selected.
- Enter a code (⇒ 45) when you select “Other ****”.

■ Subtitle Preference

Choose the language for the subtitle.

- If “Automatic” is selected and the language selected for “Soundtrack Preference” is not available, subtitles of that language will automatically appear if available on that disc.
- Enter a code (⇒ 45) when you select “Other ****”.

■ Menu Preference

Choose the language for the disc menus.

- Enter a code (⇒ 45) when you select “Other ****”.

■ Subtitle Text

Select a suitable item according to the language used for DivX or MKV subtitles text.

- This item is displayed only after playing back a file.

■ On-Screen Language

Choose the language for menus and on-screen messages.

Network

■ Easy Network Setting (⇒ 16)

■ Network Settings

Perform network-related settings individually.
Tap to show the following settings:

➤ LAN Connection Mode

Select the LAN connection method.

- Select "Wireless Master" when you make a direct wireless connection between this unit and a Home Network device. Internet connection is not available when this item is selected.

➤ Wireless Settings

This allows the wireless router and connection settings to be set. Current connection settings and connection state can be checked.

Connection Setting

The wireless router connection wizard will be displayed.

Double Speed Mode Setting (2.4GHz)

When a 2.4 GHz wireless format is used, this sets the connection speed.

- If you connect using the "Double Speed Mode (40MHz)", 2 channels use the same frequency band, and there is consequently a greater risk of reception interference. This can cause the connection speed to drop or become unstable.

➤ IP Address / DNS Settings

This is for checking the state of the network connection and setting the IP address and DNS-related.

Tap to show the respective setting.

➤ Proxy Server Settings

This is for checking the state of connection with the Proxy server and performing settings.

Tap to show the respective setting.

➤ Network Service Settings (⇒ 25) (VIERA Connect)

Tap to show the following settings:

Audio Auto Gain Control

Volume that is different depending on the contents is adjusted automatically to the standard volume while using the VIERA Connect.

- Depending on contents, this function effect will not work.
- Select "Off" when the audio is distorted.

Time Zone

By selecting the time zone, it is possible to set the unit's time to match your location.

- Some VIERA Connect contents require the time zone to be set. Set the time zone if necessary.

Summer Time

Select "On" when using Daylight Saving time.

➤ Network Drive Connection

It is possible to access the shared folder of equipment not compatible with DLNA, such as the Windows XP operating system, and play back video, still pictures, and music on this unit. For the setting and operation method of connected equipment, refer to the following website.

<http://panasonic.jp/support/global/cs/>
(This site is in English only.)

➤ Remote Device Settings (⇒ 27)

Tap to show the following settings:

Remote Device Operation

Enable to operate by DMC.

- If "On" is selected, "Quick Start" will be activated.

Device Name Entry

Set the name of this unit to be displayed on the connected equipment.

Registration Type

Automatic	Allow connection to all the equipment that is accessing this unit.
Manual	Set the permission of the connection individually for the equipment that is accessing this unit.

Remote Device List

Registering/deregistering of the displayed equipment can be performed when "Manual" in "Registration Type" is selected.

➤ BD-Live Internet Access (⇄ 23)

You can restrict Internet access when BD-Live functions are used.

- If "Limit" is selected, Internet access is permitted only for BD-Live contents which have content owner certificates.

Ratings

The following items use the same password. Don't forget your password.

■ DVD-Video Ratings

Set a ratings level to limit DVD-Video play.

■ BD-Video Ratings

Set an age limit of BD-Video play.

■ Network Service Lock

You can restrict the usage of VIERA Connect.

System

■ Easy Setting

You can execute basic settings.



■ TV Settings

Tap to show the following settings:

➤ TV Aspect

Set to match the type of television connected.

When connected to a 4:3 aspect television and playing 16:9 ratio image:

4:3 Pan & Scan	The sides are cut off so the picture fills the screen. When playing BD-Video, video is output as "4:3 Letterbox".	
4:3 Letterbox	Black bands appear at the top and bottom of the picture.	

When connected to a 16:9 widescreen television and playing 4:3 ratio image:

16:9	Video is displayed as a 4:3 ratio image in the centre of the screen.
16:9 full	Video is displayed as a horizontally stretched 16:9 image.

➤ TV System

Perform the setup so it matches the TV System of the connected TV.

➤ Screen Saver Function

This is to prevent burn-in on the screen.

- When this is set to "On":
If a list of playback content is displayed and there is no operation for 10 minutes or more, the screen switches to HOME menu automatically.
- While playing and pausing, etc., this function is not available.

➤ On-Screen Messages

Choose whether to show status messages automatically.

➤ **VIERA Link**

Set to use "HDAVI Control" function when connected via HDMI cable to a device that supports "HDAVI Control".

- Select "Off" when you do not want to use "HDAVI Control".
-

■ **Unit Settings**

Tap to show the following settings:

➤ **Standby LED**

Set the Standby/on LED to either light up or turn off when the unit is in standby mode.

➤ **Unit Operation Volume**

Set the volume of operation of this unit.

➤ **Edit User Information**

Change the user information registered in the HOME menu.

■ **Quick Start**

Speed of startup from standby mode is increased.

- When set to "On", the internal control unit will be powered and the idle power consumption will increase so compared to when set to "Off".
(About the power consumption ⇒ 44)
-

■ **Remote Control**

Change the remote control code if other Panasonic products react to this remote control.

■ **Touchpad Guide**

Show the operation guide for the touchpad.

■ **Firmware Update (⇒ 18)**

Tap to show the following settings:

➤ **Automatic Update Check**

When this equipment remains connected to the Internet, it will check for the latest firmware version when it is turned on and you can update it if necessary.

➤ **Update Now**

You can update the firmware manually if a firmware update is available.

■ **System Information**

Tap to show the following settings:

➤ **Software Licence**

Information about the software used by this unit is displayed.

➤ **Firmware Version Information**

Display firmware version of this unit and wireless LAN module.

■ **DivX Registration**

You need this registration code to purchase and play DivX Video-on-Demand (VOD) content.

■ **Default Settings**





This returns all values in the Setup menu and the Option menu to the default settings, except for some settings of network, ratings, remote control code, language, etc.

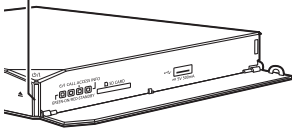

Indicator illumination

Confirm the following items in correspondence to the status of the LED of the unit.

An error condition exists when the Status LED is red. Open the panel at the side of the main unit and check the status of the indicator LEDs. If the red LED does not turn off even when following operation is performed, contact your dealer.



Indicator LEDs	Description
 <p data-bbox="106 584 325 608">Red flashes for 6 times</p>	<p data-bbox="568 398 1042 553">The remote control and main unit are using different codes. Remote control code may be changed when the battery is changed. Reset the settings of the main unit and the remote control to the states at the time of purchase with following operation.</p> <ol data-bbox="568 561 1036 769" style="list-style-type: none"> <li data-bbox="568 561 997 613">① Turn the unit off once, and then turn it on again. <li data-bbox="568 616 1036 691">② Touch and hold [▲] on the main unit for more than 4 seconds while the HOME menu is displayed. <li data-bbox="568 694 992 769">③ Press and hold [OPTION] and the green button at the same time for more than 5 seconds. <p data-bbox="568 773 1031 848">Remote control code for the main unit and the remote control will be set to "1". Change the settings as necessary. (⇒ 37, "Remote Control")</p>
<p data-bbox="106 867 452 890">The red or green light flashes slowly.</p> 	<p data-bbox="568 906 1042 981">The unit is carrying out an internal process. This is not a malfunction. You cannot operate the unit while the light is flashing. Wait for a while.</p>
<p data-bbox="106 1052 230 1075">Red lights up</p>  <p data-bbox="386 1086 471 1110">Lights up</p> <p data-bbox="386 1172 460 1196">Flashes</p>	<p data-bbox="568 1086 1036 1161">The unit fails to operate properly. Touch and hold [ϕ/I] on the main unit for 3 seconds to switch the unit to standby, then switch back on.</p>
<p data-bbox="106 1232 230 1255">Red lights up</p>  <p data-bbox="386 1266 471 1290">Lights up</p> <p data-bbox="386 1353 460 1376">Flashes</p>	<p data-bbox="568 1255 1042 1357">The USB device is drawing too much power. Please disconnect or remove the USB device from the unit. The USB device may be incompatible.</p>

<p>Red lights up</p>  <p>Lights up</p>	<p>The unit is hot.</p> <p>If the maximum operating temperature is exceeded the unit automatically switches to standby.</p> <p>In this case turn the unit off for approximately 30 minutes and make sure that there is adequate air flow around the unit.</p>
<p>Red lights up</p>  <p>Lights up</p>	<p>The copyright protected disc cannot be played back.</p> <p>One of the devices connected to the main unit via the HDMI cable (TV, amplifier, etc.) does not support copyright protection.</p>
<p>Red lights up</p>  <p>Flashes</p> <p>Lights up</p>	<p>The disc in use cannot be played back since the copyright information is invalid.</p>

Messages

Cannot play.

- You inserted an incompatible disc.

Cannot play on this unit.

- You tried to play a non-compatible image.

No disc inserted.

- The disc may be upside down.

⊘ This operation is not available.

- Some operations are unsupported by the unit. For example;
 - BD-Video: During playback, reverse slow motion or reverse frame-by-frame is not possible.

IP address is not set.

- The “IP Address” in “IP Address / DNS Settings” is “---, ---, ---, ---”. Set the “IP Address”, “Subnet Mask”, and “Gateway Address”. (Select the automatic address acquisition if necessary.)

The wireless access point currently has a low network security setting. It is recommended to change to a higher setting.

- Authentication type for the wireless LAN is set to “Open system”, or the encryption type is set to “No encryption”. It is recommended to encrypt for safety reasons. For details, refer to the instructions of the wireless router being used. Encryption is required when playing back video, etc., from DLNA compatible devices.

Troubleshooting guide

Before requesting service, please perform the following checks.

If the problem remains unresolved, consult your dealer for instructions.

Do you have the latest firmware installed?

Firmware updates may be released to correct operating irregularities that are discovered with certain movies. (⇒ 18)

The following do not indicate a problem with this unit:

- Regular disc rotating sounds.
- Image disturbance during search.
- Image disturbance when replacing 3D discs.

Unit doesn't respond to remote control or the unit's switches.

Touch and hold [⏻/I] on the main unit for 3 seconds.

- If still unable to turn the unit off, disconnect the AC mains lead, wait 1 minute, then reconnect the AC mains lead.

Cannot eject disc.

- ① Turn the unit off.
- ② Press and hold [KEYS], the yellow button and the blue button at the same time for more than 5 seconds.
 - Status LED and INFO LED start to flash.
- ③ Press the red button repeatedly until ACCESS LED lights up.



(⇒ 9, "Indicator LEDs")

- ④ Press the green button.

General operation

To return to the factory preset.

- Select "Yes" in "Default Settings" in the Setup menu. (⇒ 37)

To return all settings to the factory preset.

- Reset the unit as follows:
 - ① Turn the unit off.
 - ② Press and hold [KEYS], the yellow button and the blue button at the same time for more than 5 seconds.
 - Status LED and INFO LED start to flash.
 - ③ Press the red button repeatedly until the CALL LED lights up and ACCESS LED flashes.



(⇒ 9, "Indicator LEDs")

- ④ Press and hold the green button for more than 3 seconds.

This unit is turned off when the input for the TV is switched.

- This is a normal phenomenon when using VIERA Link (HDAVI Control 4 or later). For details please read the operating instructions for the TV.

The remote control doesn't work properly.

- Change the batteries in the remote control. (⇒ 5)
- The remote control and main unit are using different codes. If the Status LED and INFO LED flash for six times when a button is pressed on the remote control, reset the codes on the unit and the remote control. (⇒ 38)

The TV tuner mode is not displayed when the TV is switched on.

- This phenomenon may occur, depending on the TV setting, when "Quick Start" is set to "On".
- Depending on the TV, this phenomenon may be prevented by reconnecting the HDMI cable to a different HDMI input terminal or by changing the HDMI auto connection setting.

**You have forgotten your ratings password.
You want to cancel the ratings level.**

- The ratings level returns to the factory preset.
- ① Turn the unit on.
- ② Press and hold [KEYS], the yellow button and the blue button at the same time for more than 5 seconds.
 - Status LED and INFO LED start to flash.
- ③ Press the red button repeatedly until the CALL LED lights up.



- ④ Press the green button.

This unit does not recognize the USB connection correctly.

- Disconnect and reconnect the USB cable. If it still does not recognize the connection, turn this unit off and on again.
- USB devices may not be recognized by this unit when connected using the following:
 - a USB hub
 - a USB extension cable
- If you connect USB HDD to this unit, use the USB cable that is supplied with the HDD.

The switches of the unit do not work.

- Touch the switches with your finger. They may not work if operated with your fingernails or hands wearing gloves.
-

Picture

The images from this unit do not appear on the television.

Picture is distorted.

- An incorrect resolution is selected in "HDMI Video Format". Reset the setting as follows:
 - ① Turn the unit on.
 - ② Press and hold [KEYS], the yellow button and the blue button at the same time for more than 5 seconds.
 - Status LED and INFO LED start to flash.
 - ③ Press the red button repeatedly until the CALL LED flashes.



- ④ Press and hold the green button for more than 3 seconds.
 - Set the item again. (⇒ 32)
 - When Dolby Digital Plus, Dolby TrueHD, and DTS-HD audio are not output in bitstream, select "Yes" in "Default Settings" and make proper settings. (⇒ 37)
- The unit and television are using different video systems.
 - ① Turn the unit on.
 - ② Press and hold [KEYS], the yellow button and the blue button at the same time for more than 5 seconds.
 - Status LED and INFO LED start to flash.
 - ③ Press the red button repeatedly until the CALL LED flashes and ACCESS LED lights up.



- ④ Press and hold the green button for more than 3 seconds.
 - The system switches from PAL to NTSC or vice versa.
- The system used on the disc doesn't match your television.
 - PAL discs cannot be correctly viewed on an NTSC television.
- When "3D BD-Video Playback" in the Setup menu is set to "Automatic", images may not be output depending on the connection method. After removing the disc from this unit, select "Set before play" in the Setup menu, and select "2D Playback" in the setup screen displayed when playing 3D discs. (⇒ 34)

Video is not output in high-definition.

- Confirm that "HDMI Video Format" in the Setup menu is set properly. (⇒ 32)

3D video is not output.

- Change the settings as required by the connected TV format. (⇒ 34, "3D Type")
- Is there a non-3D compatible amplifier/receiver connected between this unit and a TV? (⇒ 14)
- Are the settings on this unit and the TV correct? (⇒ 23)
- Is the amplifier/receiver that is connected between this unit and TV on?
- Depending on the connected TV, the video being played back might switch to 2D video due to changes in resolution etc. Check the 3D setting on the TV.

3D video is not output correctly as 2D.

- Select "Set before play" in the Setup menu, and select "2D Playback" in the setup screen displayed when playing 3D discs. (⇒ 34, "3D BD-Video Playback")
- Discs that have recorded titles with Side by side (2 screen structure) and that can be enjoyed in 3D are played back in accordance with the settings of the TV.

A black band is displayed around the edge of the screen.

The aspect ratio of the screen is abnormal.

- Confirm the "TV Aspect" is set properly. (⇒ 36)
 - Adjust the aspect setting on the television.
-

Audio

Cannot switch audio.

- When connecting an amplifier/receiver using DIGITAL AUDIO OUT or HDMI AV OUT terminal, you cannot switch the audio if "Digital Audio Output" is set to "Bitstream". Set "Digital Audio Output" to "PCM". (⇒ 33)

Cannot hear the desired audio type.

- Check the connections and the "Digital Audio Output" settings. (⇒ 14, 33)
 - To output audio from a device connected with an HDMI cable, set "HDMI Audio Output" to "On" in the Setup menu. (⇒ 33)
-

Playback

Disc cannot be played.

- The disc is dirty. (⇒ 5)

Still pictures (JPEG) do not play back normally.

- The images that were edited on the PC, such as Progressive JPEG, etc., may not be played back.

I can't play back BD-Live.

- The SD card is write-protected. (⇒ 7)
 - Confirm that this unit is connected to the broadband Internet. (⇒ 15)
 - Confirm the "BD-Live Internet Access" settings. (⇒ 36)
 - Confirm an SD card is inserted into the SD card slot. (⇒ 19)
-

Network

I can't connect to the network.

- Confirm the network connection and settings. (⇒ 15, 16, 35)
- Check the operating instructions for each device and connect accordingly.

When using wireless LAN connection, video from the DLNA Certified media server is not played back or video frames are dropped during playback.

- Higher transfer rate router such as 802.11n (2.4 GHz) wireless router may solve the problem. If you use 802.11n (2.4 GHz) wireless router, it is necessary to set the encryption type to "AES".
Simultaneous use with a microwave, cordless telephone etc. at 2.4 GHz may result in connection interruptions or other problems.
- On the "Wireless Settings" screen (⇒ 35), the continuous lighting of at least 4 "Reception" indicators is the target for a stable connection. If 3 or fewer indicators are lit or the connection is being interrupted, change the position or angle of your wireless router and see if the connection state improves. If there is no improvement, connect to a wired network and perform the "Easy Network Setting" (⇒ 16) again.

Restriction on use of unauthorized copied content

This unit adopts the following technology for copyright protection.

Cinavia Notice

This product uses Cinavia technology to limit the use of unauthorized copies of some commercially-produced film and videos and their soundtracks. When a prohibited use of an unauthorized copy is detected, a message will be displayed and playback or copying will be interrupted.

More information about Cinavia technology is provided at the Cinavia Online Consumer Information Center at <http://www.cinavia.com>.

To request additional information about Cinavia by mail, send a postcard with your mailing address to:

Cinavia Consumer Information Center, P.O.
Box 86851, San Diego, CA, 92138, USA.

Specifications

Specifications are subject to change without notice.

Signal system	PAL/NTSC
Operating temperature range	+5 °C to +35 °C
Operating humidity range	10 % to 80 % RH (no condensation)
Digital audio output	Optical digital output (Optical terminal)
HDMI AV output	Output connector: Type A (19 pin) 1 system
SD card slot	1 system
USB slot	USB2.0 1 system
Ethernet	10BASE-T/100BASE-TX 1 system
Wireless LAN	Standard Compliance: IEEE802.11 b/g/n Frequency range: 2.4 GHz band Security: WPA™/WPA2™ (Encryption Type: TKIP/AES, Authentication Type: PSK), WEP (64 bit/128 bit)
LASER Specification	Class 1 LASER Product Wave length: 790 nm (CDs)/660 nm (DVDs)/405 nm (BDs) Laser power: No hazardous radiation is emitted with the safety protection
Power supply	DC 12 V (DC IN terminal)
Power consumption*	Approx. 8.9 W
Power consumption in standby mode*	Approx. 0.5 W
Power consumption in quick start standby mode*	Approx. 4 W
AC Adaptor	Power source: 100 to 240 V, 50/60 Hz Power consumption: 42 W DC output: DC 12 V 2500 mA
Dimensions (W×H×D) Horizontal installation with no pedestal	179 mm×27 mm×180 mm ● Including the projecting parts
Dimensions (W×H×D) Horizontal diagonal installation with pedestal	253 mm×95 mm×250 mm ● Including the projecting parts
Mass	Approx. 0.9 kg
Mass Including pedestal	Approx. 1.0 kg

* Using supplied AC adaptor

- Product Identification Marking is located on the bottom of the main unit and AC adaptor respectively.

File format

File format	Extension	Reference
MP3	“.MP3”, “.mp3”	This unit supports ID3 tags, but only titles, artist names and album names can be displayed.
JPEG	“.JPG”, “.jpg”	<ul style="list-style-type: none"> ● MOTION JPEG and Progressive JPEG are not supported. ● You may not be able to play back the file if you have edited the folder structure or the file name on a PC or other device.
DivX	“.DIVX”, “.divx”, “.AVI”, “.avi” Subtitles text file “.SRT”, “.srt”, “.SUB”, “.sub”, “.TXT”, “.txt”	<ul style="list-style-type: none"> ● The video file and subtitles text file are inside the same folder, and the file names are the same except for the file extensions. ● Some DivX and MKV file may not play back, depending on the video resolution and frame rate condition.
MKV	“.MKV”, “.mkv” Subtitles text file “.SRT”, “.srt”, “.SSA”, “.ssa”, “.ASS”, “.ass”	
FLAC	“.flac”	Maximum sampling rate: 192 kHz/24 bit
WAV	“.wav”	Maximum sampling rate: 48 kHz/16 bit
MPO	“.mpo”	3D still picture

- With certain recording states and folder structures, the play order may differ or playback may not be possible.

Audio information

The audio output differs depending on which terminals are connected to the amplifier/receiver, and the settings on the unit. (⇒ 33, Digital Audio Output)

- The number of channels listed is the maximum possible number of output channels when connected to amplifier/receiver compatible with the respective audio format.

Terminal	“Digital Audio Output”	
	“Bitstream”	“PCM”
HDMI AV OUT	Outputs using original audio ¹	BD-Video : 7.1ch PCM ¹⁾¹² DVD-Video : 5.1ch PCM
DIGITAL AUDIO OUT	Dolby Digital/ DTS Digital Surround	Down-mixed 2ch PCM

¹ When “BD-Video Secondary Audio” is set to “On”, the audio will be output as Dolby Digital, DTS Digital Surround or 5.1ch PCM.

² The audio output is amplified from 5.1ch or 6.1ch to 7.1ch depending on the DTS, Inc. specifications.

Precautions for wireless LAN connection

The following limits are in place regarding the usage of this unit. You must be aware of these limits before using this unit.

Panasonic will in no way be responsible for any incidental damage which may arise due to a failure to obey these limits, or to any condition of use or disuse of this unit.

● **Data transmitted and received over radio waves may be intercepted and monitored.**

● **This unit contains delicate electronic components.**

Please use this unit in the manner in which it was intended and follow the following points:

- Do not expose this unit to high temperatures or direct sunlight.
- Do not bend, or subject this unit to strong impacts.
- Keep this unit away from moisture.
- Do not disassemble or alter this unit in any way.



Declaration of Conformity (DoC)

Hereby, "Panasonic Corporation" declares that this product is in compliance with the essential requirements and other relevant provisions of Directive 1999/5/EC.

Customers can download a copy of the original DoC to our R&TTE products from our DoC server:

<http://www.doc.panasonic.de>

Contact in the EU: Panasonic Services Europe, a Division of Panasonic Marketing Europe GmbH, Panasonic Testing Centre, Winsbergring 15, 22525 Hamburg, Germany

This product is intended to be used in the following countries.

Austria, Belgium, Bulgaria, Cyprus, Czech Republic, Denmark, Finland, France, Germany, Greece, Hungary, Ireland, Italy, Iceland, Liechtenstein, Luxembourg, Malta, Netherlands, Norway, Poland, Portugal, Romania, Slovakia, Slovenia, Spain, Sweden, United Kingdom, Switzerland

This product is intended for general consumer. (Category 3) The WLAN feature of this product shall exclusively be used inside buildings.

This product on purpose to connect to access point of 2.4 GHz WLAN.



Supplemental information

■ Display languages list

Display Language	Display Language	Display Language
ENG English	JPN Japanese	ARA Arabic
FRA French	CHI Chinese	HIN Hindi
DEU German	KOR Korean	PER Persian
ITA Italian	MAL Malay	IND Indonesian
ESP Spanish	VIE Vietnamese	MRI Maori
NLD Dutch	THA Thai	BUL Bulgarian
SVK Swedish	POL Polish	RUM Romanian
NOR Norwegian	CES Czech	GRE Greek
DAN Danish	SLK Slovak	TUR Turkish
POR Portuguese	HUN Hungarian	* Others
RUS Russian	FIN Finnish	

■ Language code list

Language Code	Language Code	Language Code
Abkhazian: 6566	Gujarati: 7185	Rhaeto-Romance: 8277
Afar: 6565	Hausa: 7265	Russian: 8285
Afrikaans: 6570	Hebrew: 7387	Samoan: 8377
Albanian: 8381	Hindi: 7273	Sanskrit: 8365
Amharic: 6577	Hungarian: 7285	Scots Gaelic: 7168
Arabic: 6582	Icelandic: 7383	Serbian: 8382
Armenian: 7289	Indonesian: 7378	Serbo-Croatian: 8372
Assamese: 6583	Interlingua: 7365	Shona: 8378
Aymara: 6589	Irish: 7165	Sindhi: 8368
Azerbaijani: 6590	Italian: 7384	Singhalese: 8373
Bashkir: 6665	Japanese: 7465	Slovak: 8375
Basque: 6985	Javanese: 7487	Slovenian: 8376
Bengali; Bangla: 6678	Kannada: 7578	Somali: 8379
6678	Kashmiri: 7583	Spanish: 6983
Bhutani: 6890	Kazakh: 7575	Sundanese: 8385
Bihari: 6672	Kirghiz: 7589	Swahili: 8387
Breton: 6682	Korean: 7579	Swedish: 8386
Bulgarian: 6671	Kurdish: 7585	Tagalog: 8476
Burmese: 7789	Laotian: 7679	Tajik: 8471
Byelorussian: 6669	Latin: 7665	Tamil: 8465
Cambodian: 7577	Latvian, Lettish: 7686	Tatar: 8484
Catalan: 6765	Lingala: 7678	Telugu: 8469
Chinese: 9072	Lithuanian: 7684	Thai: 8472
Corsican: 6779	Macedonian: 7775	Tibetan: 6679
Croatian: 7282	Malagasy: 7771	Tigrinya: 8473
Czech: 6783	Malay: 7783	Tonga: 8479
Danish: 6865	Malayalam: 7776	Turkish: 8482
Dutch: 7876	Maltese: 7784	Turkmen: 8475
English: 6978	Maori: 7773	Tw: 8487
Esperanto: 6979	Marathi: 7782	Ukrainian: 8575
Estonian: 6984	Moldavian: 7779	Urdu: 8582
Faroese: 7079	Mongolian: 7778	Uzbek: 8590
Fiji: 7074	Nauru: 7865	Vietnamese: 8673
Finnish: 7073	Nepali: 7869	Volapuk: 8679
French: 7082	Norwegian: 7879	Welsh: 6789
Frisian: 7089	Oriya: 7982	Wolof: 8779
Galician: 7176	Pashto, Pushto: 8083	Xhosa: 8872
Georgian: 7565	Persian: 7065	Yiddish: 7473
German: 6869	Polish: 8076	Yoruba: 8979
Greek: 6976	Portuguese: 8084	Zulu: 9085
Greenlandic: 7576	Punjabi: 8065	
Guarani: 7178	Quechua: 8185	

<p>"AVCHD", "AVCHD 3D", "AVCHD Progressive" and "AVCHD 3D/Progressive" are trademarks of Panasonic Corporation and Sony Corporation.</p>
<p>Java is a registered trademark of Oracle and/or its affiliates.</p> 
<p>Manufactured under license from Dolby Laboratories. Dolby and the double-D symbol are trademarks of Dolby Laboratories.</p>
<p>Manufactured under license under U.S. Patent Nos: 5,956,674; 5,974,380; 6,226,616; 6,487,535; 7,392,195; 7,272,567; 7,333,929; 7,212,872 & other U.S. and worldwide patents issued & pending. DTS-HD, the Symbol, & DTS-HD and the Symbol together are registered trademarks & DTS-HD Master Audio Essential is a trademark of DTS, Inc. Product includes software. © DTS, Inc. All Rights Reserved.</p>
<p>HDMI, the HDMI Logo, and High-Definition Multimedia Interface are trademarks or registered trademarks of HDMI Licensing LLC in the United States and other countries.</p>
<p>This product is licensed under the AVC patent portfolio license and VC-1 patent portfolio license for the personal and non-commercial use of a consumer to (i) encode video in compliance with the AVC Standard and VC-1 Standard ("AVC/VC-1 Video") and/or (ii) decode AVC/VC-1 Video that was encoded by a consumer engaged in a personal and non-commercial activity and/or was obtained from a video provider licensed to provide AVC/VC-1 Video. No license is granted or shall be implied for any other use. Additional information may be obtained from MPEG LA, LLC. See http://www.mpegla.com.</p>
<p>HDAVI Control™ is a trademark of Panasonic Corporation.</p>
<p>VIERA Connect is a trademark of Panasonic Corporation.</p>
<p>MPEG Layer-3 audio coding technology licensed from Fraunhofer IIS and Thomson.</p>
<p>SDXC Logo is a trademark of SD-3C, LLC.</p>
<p>"DVD Logo" is a trademark of DVD Format/Logo Licensing Corporation.</p>
<p>The Wi-Fi CERTIFIED Logo is a certification mark of the Wi-Fi Alliance. The Wi-Fi Protected Setup Mark is a mark of the Wi-Fi Alliance.</p>  
<p>"Wi-Fi", "Wi-Fi Protected Setup", "Wi-Fi Direct", "WPA" and "WPA2" are marks or registered marks of the Wi-Fi Alliance.</p>
<p>DivX®, DivX Certified® and associated logos are trademarks of Rovi Corporation or its subsidiaries and are used under license.</p>
<p>ABOUT DIVX VIDEO: DivX® is a digital video format created by DivX, LLC, a subsidiary of Rovi Corporation. This is an official DivX Certified® device that plays DivX video. Visit divx.com for more information and software tools to convert your files into DivX videos.</p>
<p>ABOUT DIVX VIDEO-ON-DEMAND: This DivX Certified® device must be registered in order to play purchased DivX Video-on-Demand (VOD) movies. To obtain your registration code, locate the DivX VOD section in your device setup menu. Go to vod.divx.com for more information on how to complete your registration.</p>

DLNA, the DLNA Logo and DLNA CERTIFIED are trademarks, service marks, or certification marks of the Digital Living Network Alliance.

Windows is a trademark or a registered trademark of Microsoft Corporation in the United States and other countries.

Skype, associated trade marks and logos and the "S" logo are trade marks of Skype Limited.

This product incorporates the following software:

- (1) the software developed independently by or for Panasonic Corporation,
- (2) the software owned by third party and licensed to Panasonic Corporation,
- (3) the software licensed under the GNU General Public License, Version 2 (GPL v2),
- (4) the software licensed under the GNU LESSER General Public License, Version 2.1 (LGPL v2.1) and/or,
- (5) open sourced software other than the software licensed under the GPL v2 and/or LGPL v2.1

For the software categorized as (3) and (4), please refer to the terms and conditions of GPL v2 and LGPL v2.1, as the case may be at <http://www.gnu.org/licenses/old-licenses/gpl-2.0.html> and <http://www.gnu.org/licenses/old-licenses/lgpl-2.1.html>.

In addition, the software categorized as (3) and (4) are copyrighted by several individuals. Please refer to the copyright notice of those individuals at

<http://panasonic.net/avc/oss/bdplayer/AWBPP12.html>

The GPL/LGPL software is distributed in the hope that it will be useful, but WITHOUT ANY WARRANTY, without even the implied warranty of MERCHANTABILITY or FITNESS FOR A PARTICULAR PURPOSE.

At least three (3) years from delivery of products, Panasonic will give to any third party who contacts us at the contact information provided below, for a charge no more than our cost of physically performing source code distribution, a complete machine-readable copy of the corresponding source code covered under GPL v2/LGPL v2.1.

Contact Information

cdrequest.bdplayer@gg.jp.panasonic.com

Source code is also freely available to you and any other member of the public via our website below.

<http://panasonic.net/avc/oss/bdplayer/AWBPP12.html>

For the software categorized as (5) includes as follows.

1. This product includes software developed by the OpenSSL Project for use in the OpenSSL Toolkit. (<http://www.openssl.org/>)
2. This product includes software developed by the University of California, Berkeley and its contributors.
3. FreeType code.
4. The Independent JPEG Group's JPEG software.

(1) MS/WMA

This product is protected by certain intellectual property rights of Microsoft Corporation and third parties. Use or distribution of such technology outside of this product is prohibited without a license from Microsoft or an authorized Microsoft subsidiary.

(2) MS/PlayReady/Final Product Labeling

This product contains technology subject to certain intellectual property rights of Microsoft. Use or distribution of this technology outside of this product is prohibited without the appropriate license(s) from Microsoft.

(3) MS/PlayReady/End User Notices

Content owners use Microsoft PlayReady™ content access technology to protect their intellectual property, including copyrighted content. This device uses PlayReady technology to access PlayReady-protected content and/or WMDRM-protected content. If the device fails to properly enforce restrictions on content usage, content owners may require Microsoft to revoke the device's ability to consume PlayReady-protected content. Revocation should not affect unprotected content or content protected by other content access technologies. Content owners may require you to upgrade PlayReady to access their content. If you decline an upgrade, you will not be able to access content that requires the upgrade.

(4) Vorbis, FLAC, WPA Supplicant

The software licenses are displayed when "Software Licence" in the Setup menu is selected. (⇒ 37)

Copyright 2004-2010 Verance Corporation. Cinavia™ is a Verance Corporation trademark. Protected by U.S. Patent 7,369,677 and worldwide patents issued and pending under license from Verance Corporation. All rights reserved.

Sales and Support Information

Customer Communications Centre

- For customers within the UK: 0844 844 3899
- For customers within Ireland: 01 289 8333
- For further support on your product, please visit our website:
www.panasonic.co.uk

Direct Sales at Panasonic UK

- Order accessory and consumable items for your product with ease and confidence by phoning our Customer Communications Centre Monday–Thursday 9:00 a.m.–5:30 p.m., Friday 9:30 a.m.–5:30 p.m. (Excluding public holidays)
- Or go on line through our Internet Accessory ordering application at www.pas-europe.com.
- Most major credit and debit cards accepted.
- All enquiries transactions and distribution facilities are provided directly by Panasonic UK.
- It couldn't be simpler!
- Also available through our Internet is direct shopping for a wide range of finished products. Take a browse on our website for further details.

Pursuant to at the directive 2004/108/EC, article 9(2)

Panasonic Testing Centre
Panasonic Marketing Europe GmbH
Winsbergring 15, 22525 Hamburg, Germany



Environment friendly printed on chlorine free bleached paper.

Panasonic Corporation
Web Site: <http://panasonic.net>



En

© Panasonic Corporation 2012

VQT3W24
F0412ST0