

HDD Extension Unit

INSTALLATION AND OPERATION MANUAL

MODEL

DX-ZD6UE

ENGLISH

DEUTSCH

FRANÇAIS

ESPAÑOL

РУССКИЙ

ITALIANO

NEDERLANDS



THIS INSTRUCTION MANUAL IS IMPORTANT TO YOU. PLEASE READ IT BEFORE USING YOUR HDD EXTENSION UNIT.

Caution and care

HEAVY OBJECTS SHOULD NEVER BE PLACED ON THE UNIT (E.G., MONITOR)

NEVER TOUCH OR INSERT ANY OBJECT INSIDE THE UNIT

Touching the inside of the cabinet or inserting foreign objects of any kind through the ventilation holes not only creates a safety hazard but can also cause extensive damage.

PROTECT THE POWER CORD

Damage to the power cord may cause fire or shock hazard. If the mains cord is damaged, turn OFF the MAIN switch and carefully unplug the cord by holding the mains plug.

If this unit is moved with the power on status, the HDDs may be damaged. Ensure that more than one minute have passed since the power cord and the connecting cords were disconnected, then move this unit.

UNPLUG THE POWER CORD DURING A LONG ABSENCE

Turn off the power and unplug the power cord during a long absence.

MAINTAIN GOOD VENTILATION

Do not obstruct the many ventilation holes on the unit. For maximum ventilation, leave some space around the unit and place the unit on a hard level surface only, and ensure it is not covered during use. Heavy objects should never be placed on the unit.

WHEN NOT IN USE

When not in use, always turn OFF the MAIN switch.

CABINET CARE

Never use petroleum-based cleaners. They may cause deterioration or coat flaking of the unit. Clean with a soft cloth moistened with soap and water and wipe dry.

When using chemical duster, follow the instructions.

INSTALLATION LOCATION

For excellent performance and lasting reliability install in a location that is:-

1. Well ventilated, out of direct sunlight and away from direct heat.
2. A solid vibration-free surface.
3. Free from high humidity, excessive dust and away from magnetic fields.
4. Please ensure that the ventilation fan located on the unit's back panel is not blocked.

UNSUITABLE LOCATIONS

Placing the unit in the following places might shorten the product life:

- Extremely cold places, such as refrigerated warehouses and ice houses
- Places where excessive hydrogen sulfide is likely to be generated, such as hot-springs areas
- Places or locations with salt air environment.

NO OBJECTS FILLED WITH LIQUIDS, SUCH AS VASES, SHALL BE PLACED ON THE APPARATUS.

DO NOT PLACE HEAVY OBJECT ON THIS UNIT.

DO NOT STEP ONTO THIS UNIT.

WARNING: TO PREVENT FIRE OR SHOCK HAZARD, DO NOT EXPOSE THIS APPARATUS TO RAIN OR MOISTURE. THIS APPARATUS MUST BE GROUNDED.

This unit complies with the requirements of the EC Directive 2004/108/EC, "EMC Directive" and 2006/95/EC, "Low Voltage Directive". The requirements for the susceptibility according to EN 55024 and the requirements for interference according to EN 55022 are observed for the operation on residential areas, business, light industrial premises and in small scale enterprises, inside as well as outside of the building. All places of operation are characterised by their connection to the public low voltage power supply system. This unit is manufactured in accordance with EN 60950-1.



Note: This symbol mark is for EU countries only.

This symbol mark is according to the directive 2002/96/EC Article 10 Information for users and Annex IV.

Your MITSUBISHI ELECTRIC product is designed and manufactured with high quality materials and components which can be recycled and reused.

This symbol means that electrical and electronic equipment, at their end-of-life, should be disposed of separately from your household waste.

Please, dispose of this equipment at your local community waste collection/recycling centre.

In the European Union there are separate collection systems for used electrical and electronic product.

Please, help us to conserve the environment we live in!

WARNING:

The power cords for use in the U.S., the continent of Europe, and U.K. are included with this unit.

Use the appropriate one for your country.

The power cord for use in the U.S. is used for 120V only. Never connect to any outlet or power supply having a different voltage or frequency.

MAINS LEAD CONNECTION

The mains lead on this Unit is fitted with a non-rewireable mains plug, incorporating a 5A fuse. If you need to replace the fuse, use a 5A fuse approved by BSI or ASTA to BS 1362, ensuring you refit the fuse cover. If the mains plug is not suitable for the sockets in your home, and you require to remove the plug, remove the fuse, cut off the plug then dispose of the plug immediately, to avoid a possible electric shock hazard. To refit a new plug, follow these instructions; Green-and-yellow: Earth, Blue: Neutral and Brown: Live. As the colours in the mains lead of this Unit may not correspond with the coloured markings identifying the terminals in your plug, proceed as follows.

- The wire which is coloured green-and-yellow must be connected to the terminal in the plug which is marked by the letter E or by the safety earth symbol \perp or coloured green or green-and-yellow.
- The wire which is coloured blue must be connected to the terminal which is marked with the letter N or coloured black.
- The wire which is coloured brown must be connected to the terminal which is marked with the letter L or coloured red.

Before you start recording important images, make sure to perform trial recording to ensure that images are properly recorded. Mitsubishi assumes no responsibility or reliability for any loss of recorded data and any failure of playback data arising out of malfunction of this unit or the connected device. It is recommended that backups of important recordings are made regularly as a precaution against possible breakdowns and accidents.

- This unit uses a hard disk, which is a precision device. Please handle this unit with sufficient care.
- Do not subject this unit to vibrations or shocks. Vibrations and shocks may cause trouble especially while the recorder is on or the hard disc drive is being accessed.
- Do not disconnect the power plug or the USB cable while the power of the unit is turned on or while recording or playing.
- It is recommended to ask for inspection every one year for early detection of failure.
- Do not move this unit at least one minute after the power is turned off.
- If the power plug is disconnected or the breaker switch is turned off during recording, HDD may be damaged or playback of recorded data may become impossible.
If the breaker switch is turned on and off everyday, set the timer recording to be performed only for the period that the breaker is on and do not turn off the breaker during recording.
- It is recommended to check periodically that recording is performed successfully by playing back the recorded data.

The HDD and cooling fan of this unit are driving parts. For stable recording, it is recommended that both of these parts are replaced every 30,000 hours.

(This interval is for reference purpose only and does not indicate the warranty period of the parts.)

INSTALLATION LOCATION AND HANDLING

- Do not plug this unit into the same outlet which is being used for other large power consuming equipment such as a copying machine and air conditioner.
- Do not place this unit close to other equipment to prevent adverse interference between them.
- Do not place this unit close to strong magnetized objects. They may cause effects on the images or loss of recorded data.
- Never apply volatile substances such as insecticides and do not put rubber- or plastic-products on the unit for a long period. They may cause deterioration of this unit or flaking of the coating.
- Install the unit within the allowable ambient temperature range (5 °C to 40 °C) and relative humidity range (less than 80%). Using this unit out of these ranges may adversely affect the internal parts or cause malfunction. When the temperature of the HDD rises high, its performance may deteriorate or its lifetime may be shortened. When using this unit at a low temperature, turn on the power and wait for 10 minutes or more before use.

WHEN MOVING THIS UNIT

- When you move this unit, make sure to turn off the power and unplug. When a strong shock is applied to this unit while it is on, the electronic parts inside the unit may be damaged. Take care especially while the ACCESS indicator is illuminating.
- When you move this unit, wrap it with cushions to avoid shock to the internal parts.

COPYRIGHT

- This unit records images digitally. When recording copyrighted images, be careful not to infringe their copyrights.

Disclaimer

In any event, Mitsubishi assumes no responsibility or reliability for the following:

1. Disassembly, repair, or alteration of this unit by user or installer.
2. Failure or breakdown in or damage to this unit resulting from misuse or careless handling by user or installer.
3. Inconvenience or damages arising out of inability to display or record images due to any reason or cause other than breakdown or failure in this unit.
4. Failure in this unit due to combination with other equipment manufactured by a third party or inconvenience or damages resulting from such failure.
5. Inconvenience, damages, or claims arising out of breakdown in this unit or loss of recorded video data due to replacement of the HDD by user or installer.
6. Inconvenience or damages arising out of breakdown in this unit or inability to display or record images due to natural disaster including earthquake and storm.
7. Inconvenience, damages, or claims arising out of breakdown in this unit or loss of recorded video data due to impact or vibration to the HDD or an environmental factor such as temperature at the installation site.
8. Demand for damages or other claim of infringement of privacy if the images monitored or recorded by user become public or are used for any purpose other than surveillance for whatever reason.

Features/Contents

Features

HDD extension unit having a large-capacity hard disc drive (HDD)

This unit is equipped with a high-reliability, high-speed, and large-capacity hard disc drive.

HDD operation mode

Among 2 HDD operation modes of spanning and mirroring, you can select the desired one.

Power linkage function

The power of this unit can be turned on/off by linking with the connected MITSUBISHI digital recorder's power supply.

Warning function

This unit is equipped with the terminal for informing of abnormal temperature rise and HDD error.

Direct connection with a personal computer

You can connect this unit to a personal computer directly via a USB cable and playback the data recorded by this unit on the personal computer using the special playback software. Consult your dealer for the special playback software.

The name of this unit is shown on the personal computer as follows.

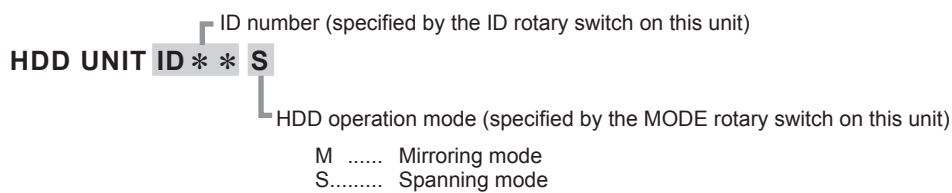

Contents

Important safeguards	i-iv	Replacing the HDD	14
Caution and care	2	Precautions for replacing the HDD.....	14
Features	4	Removing the HDD.....	14
Contents	4	Attaching the HDD.....	16
Major operations and their functions	5	Troubleshooting	18
Front view.....	5	Diagnosis by HDD indicators.....	18
Rear view.....	6	Troubleshooting.....	19
Connections	8	Maintenance.....	19
Connectable recorders.....	8	Specifications	20
Connection example.....	8	◆ How to read this manual	
Connection to link the power supply of the recorder and this unit.....	8	Viewing displays	
Precautions for connection.....	9	Tips (Refer to this information when operating):	
Startup.....	10	Reference information concerning operation	
Setting the ID number of this unit	11	Notice (Caution required):	
Setting the ID number of this unit.....	11	Cautionary items concerning operation	
Setting the mode of this unit	12	Hand (See reference page):	
HDD operation mode.....	12	Reference item and page number	
Mode selection.....	12		

Warning

This is a class A product. In a domestic environment this product may cause radio interference in which case the user may be required to take adequate measures.

Front view

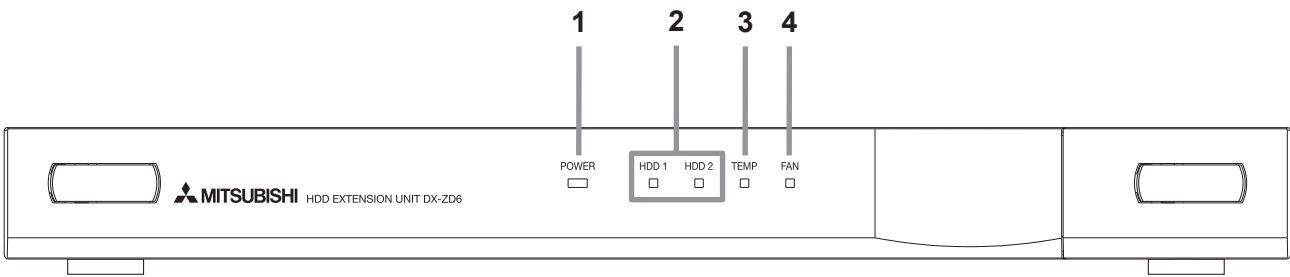

1 POWER indicator

When the EXTERNAL CONTROL switch is set to OFF or it is set to ON with the connected recorder turned on, this indicator illuminates while the MAIN switch on the rear panel is turned on.

2 HDD1, HDD2 indicators (ACCESS indicators)

While HDD 1 or HDD 2 is being accessed, the corresponding indicator momentarily blinks green.

They keep blinking during recording/copying of data.

In case of an error, they blink or illuminate red. (See page 18.)

3 TEMP indicator

Illuminates when the internal temperature of this unit becomes high.

4 FAN indicator

Illuminates when the fan stops.

Rear view

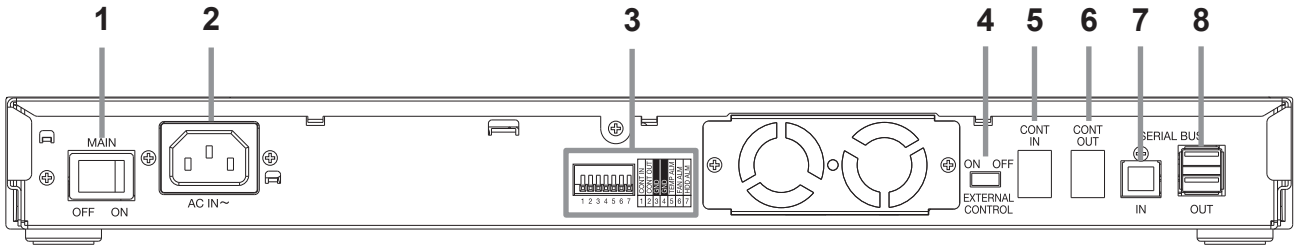

1 MAIN switch

This is the main power switch. When using this unit, set this switch to ON.

2 AC power socket

Used to connect the power cord. Earth terminal is used for safety. Make sure to use the 100 to 240 V plug with earth for the power of this unit.

Notice

- When the power outlet does not have an earth terminal, ask your dealer for the earth work (pay service). Never connect the earth terminal of the power plug to a gas pipe, water pipe, conductor rod, and so on.
- Use the supplied AC power cord.
- Make sure to plug this unit into the outlet of the same power line that is used for the recorder connected. When this unit is plugged into the outlet of other line, recording or copying will not be resumed correctly after a power failure.

3 I/O terminals

CONT IN terminal

Terminal for inputting the power on/off status of the recorder. Connect this terminal with the DC 12V OUT terminal on the rear of the recorder.

CONT OUT terminal

Terminal for outputting the power on/off status of the recorder. When using multiple number of HDD extension units and using the power on/off linkage function, connect this terminal with the CONT IN terminal on the rear of the HDD extension unit to be connected.

GND terminals

They are the common GND terminals. When using the power on/off linkage function, connect this terminal with the GND terminal on the rear of the recorder.

TEMP ALM terminal

Terminal for informing of high internal temperature.

FAN ALM terminal

Terminal for informing of abnormality of the fan.

HDD ALM terminal

Terminal for informing of abnormality of the HDD.

4 EXTERNAL CONTROL switch

Set this switch to ON (left side) to turn on and off the power of this unit linking with the recorder's switch. When not linking with the recorder, set this switch to OFF (right side).

Notice

- When the EXTERNAL CONTROL switch is set to ON, make sure to perform "Connection to link the power supply of the recorder and this unit" on page 8. When the recorder is turned on, this unit is turned on at the same time.
- It is recommended to link this unit with the recorder in order to allow the internal hard disks to rest or to properly handle a problem, if occurs.

5 CONT IN terminal

Reserved.

6 CONT OUT terminal

Reserved.

7 SERIAL BUS IN port

Port for connecting with the recorder.

8 SERIAL BUS OUT ports

Ports for connecting with another DX-ZD6UE when using multiple number of DX-ZD6UE.

Notice

- It is impossible to supply 5V DC power from this port.
- Do not connect any devices other than DX-ZD6UE to these output ports.

Connections

Connectable recorders

MITSUBISHI DIGITAL RECORDER

- DX-TL5000 series (DX-TL5000U, DX-TL5000E, DX-TL5000UA, DX-TL5000E400, DX-TL5000E(Z))
- DX-TL4500 series (DX-TL4516E, DX-TL4516E(Z), DX-TL4516U, DX-TL4509E, DX-TL4509E(Z), DX-TL4509U)

The above stated models are connectable as of October 2007. Consult your dealer for the connection with other recorders.

Connection example

- Connect this unit and a digital recorder by using the supplied USB cable.
- You can connect multiple DX-ZD6UE as shown below.

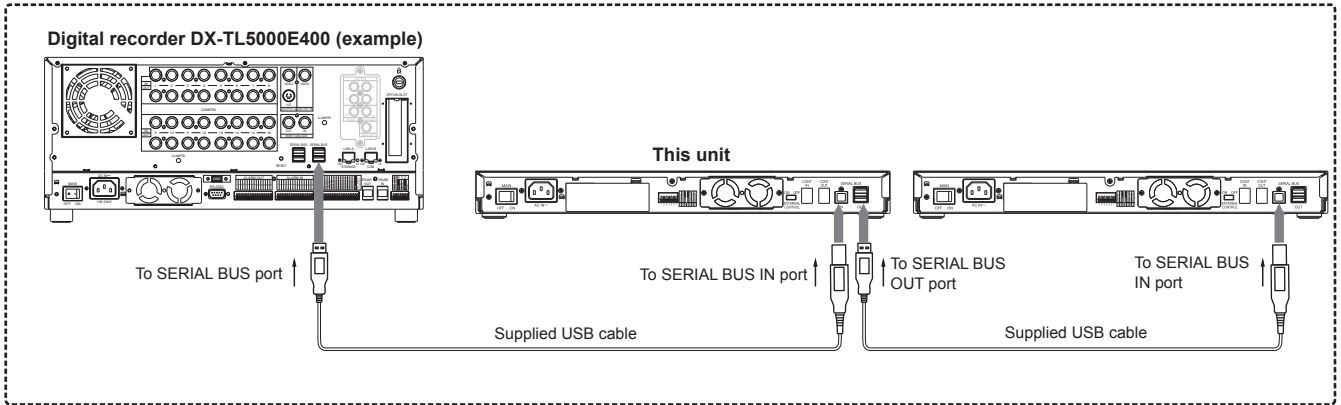

◆ Connection to link the power supply of the recorder and this unit

- Set the EXTERNAL CONTROL switch to ON (left side) and connect the terminals as shown below. It is recommended to link this unit with the recorder's power supply.
- To resume recording or copying after a power failure during normal recording or timer recording, plug this unit into the outlet of the same power line that is used for the recorder connected.

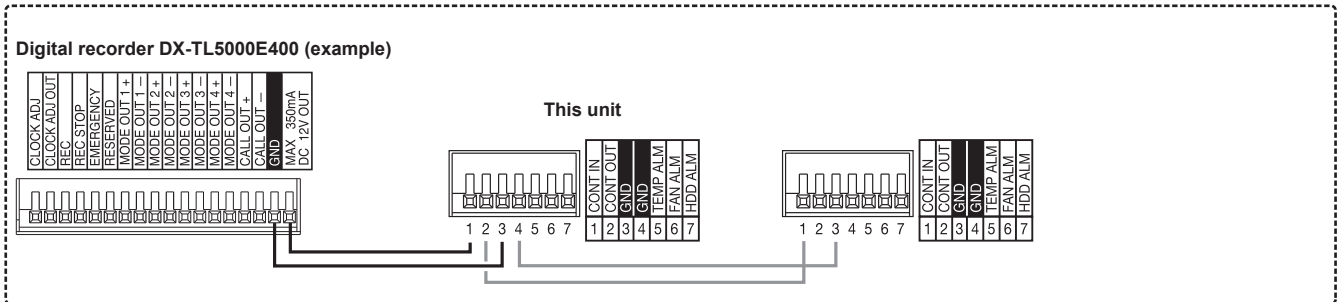

◆ Precautions for connection

Notice

- When connecting 5 or more HDD extension units (with 2 HDDs mounted on each unit) to the digital recorder, you are recommended to use USB cable as illustrated below to prevent recognition error of digital recorder due to different start-up times among HDDs.

Furthermore, before you start operation or when the power restores from a power failure, check that the HDDs are recognized correctly even when a small number of HDD extension units are connected.

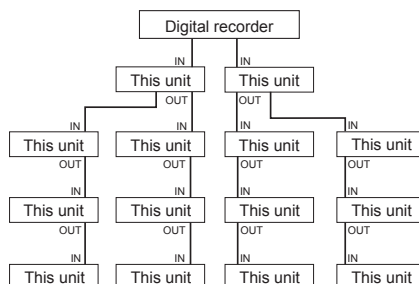

* When 2 serial bus ports are used.

- The EXTERNAL CONTROL switch is set to ON by default. In this status, this unit does not work even though you connect the power cord and set the MAIN switch to ON.

Connect this unit and the recorder as “Connection to link the power supply of the recorder and this unit” on page 10.

Tips

- The available number of HDD extension units to be connected varies depending on the recorder connected. Check the specification of the recorder.
- You cannot connect 6 or more HDD extension units in series using serial bus.
- The number of serial bus ports varies depending on the digital recorder connected. For stable recording, it is recommended to use the ports of the recorder as many as possible to avoid branch connection of the extension units.

Startup

Step 1 Turn ON the MAIN switch on the rear of this unit.

Step 2 Turn on the MAIN switch on the rear of the recorder.

- The POWER indicator of this unit illuminates when the power supply of this unit is not linked with the recorder.

Step 3 After “POWER OFF” is displayed on the LCD of the recorder, press the POWER button on the front panel of the recorder.

- The indicators of HDD 1 and HDD 2 on the front panel of this unit momentarily blink green.
- When the power supply of this unit is linked with the recorder, you can turn on the power of this unit by pressing the POWER button on the front panel of the recorder.
- When the power of the recorder is turned on, the connection is completed.

Tips>

- For the operation of the recorder, refer to the installation and operation manual supplied with the recorder.

Setting the ID number of this unit

Setting the ID number of this unit

Step 1 Turn OFF the MAIN switch on the rear of this unit.

Step 2 Remove the cover of this unit according to steps 1 to 3 of “Removing the HDD” on  page 14.

- The ID number is set using the ID rotary switch inside the cover.

<Inside the front cover>

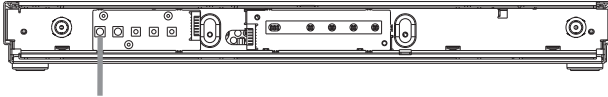

ID rotary switch

Step 3 Set the ID rotary switch to the desired number.

- The ID number set in this step is displayed on the digital recorder's menu screen that is used to register the device.

ID rotary switch	ID number	
	Spanning operation	Mirroring operation
0	ID00S	ID00M
1	ID01S	ID01M
2	ID02S	ID02M
3	ID03S	ID03M
4	ID04S	ID04M
5	ID05S	ID05M
6	ID06S	ID06M
7	ID07S	ID07M
8	ID08S	ID08M
9	ID09S	ID09M
A	ID10S	ID10M
B	ID11S	ID11M
C	ID12S	ID12M
D	ID13S	ID13M
E	ID14S	ID14M
F	ID15S	ID15M

Step 4 Attach the cover of this unit according to steps 9 to 11 of “Attaching the HDD” on  page 17.

Step 5 Turn ON the MAIN switch on the rear of this unit.

Setting the mode of this unit

HDD operation mode

This unit has 2 HDD operation modes as described below.

■ Spanning mode

This mode regards and uses 2 built-in HDDs as 1 HDD. The total data capacity of 2 HDDs is available.

Notice

- When either of the HDDs fails in the spanning mode, both of the HDDs become unusable and the recorded data are deleted.

■ Mirroring mode

This mode records the same data to 2 built-in HDDs simultaneously.

Even when either of the HDDs fails, by replacing the failed HDD, the data stored in the other HDD are automatically copied to the newly mounted HDD and the HDDs are restored to the condition before the failure. (Data synchronization)

Synchronization of 500-GB data takes about 8 hours. This time is approximate and given as a guide only, assuming that this unit performs no other operations during the data synchronization. Therefore, a longer time is required for the data synchronization when the unit is in the playback or recording mode.

When the data synchronization is interrupted by the operation such as power-off, the unit resumes the synchronization after the power is restored.

Notice

- When you replace the failed HDD in the mirroring mode, make sure to use an unused HDD. If you mount a used HDD, delete the management information of that HDD. (See “How to set the mode” on the right column.) If you mount a used HDD without deleting its management information, the data synchronization may not be performed correctly. (Do not delete the management information with the existing normal HDD mounted because the data is deleted.)

Mode selection

Step 1 Turn OFF the MAIN switch on the rear of this unit.

Step 2 Remove the cover of this unit according to the steps 1 to 3 of “Removing the HDD” on page 14.

- The mode is set using the MODE rotary switch inside the cover.

<Inside the front cover>

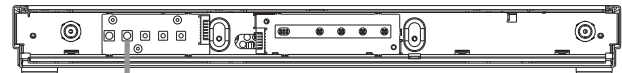

MODE rotary switch

Step 3 Set the MODE rotary switch to 7.

- Before you change the HDD operation mode, delete the management information according to steps 3 to 5. You may skip these steps when you mount an unused HDD. When you mount a used HDD, the HDD cannot be used properly unless the management information is deleted before changing the HDD operation mode.

Step 4 Press the RESET button.

Step 5 After the unit boots up and the buzzer sounds, press the TEST button.

- The management information deletion function is activated and the ACCESS indicator starts blinking. Upon completion of the deletion, the indicator illuminates green.

Step 6 Set the MODE rotary switch to the number corresponding to the desired operation mode.

MODE rotary switch	HDD operation mode
0	Do not use.
1	Spanning
2	Mirroring
3	Do not use.
4	Do not use.
5	Do not use.
6	Do not use.
7	Do not use.
8	Do not use.
9	Do not use.

Step 7 Attach the cover of this unit according to steps 9 to 11 of “Attaching the HDD” on  page 17.

Step 8 Turn ON the MAIN switch on the rear of the unit.

Replacing the HDD

Precautions for replacing the HDD

WARNING

- Do not remove the top cover of the unit.

Notice

- Before you replace the HDD, read "Important safeguards" on pages i to iv and "Caution and Care" on pages 2 and 3 again.
- Do not attach or remove the HDD unnecessarily. Attaching or removing the HDD of this unit is intended for replacing a failed HDD, not for use as a removable HDD.
- Make sure that the MAIN switch on the rear panel is turned OFF when attaching or removing the HDD. Wait at least 1 minute after turning off the power. When a recorder is connected, turn off the recorder, too.
- When a power failure occurs during recording, avoid adding, replacing or transporting the HDD. In case of a power failure, as the recorded data may be erased, turn the power back on to boot up the unit with the HDD that was being used at the time of the power failure attached. Then add, replace or transport the HDD.
- When the USB cable connected to this unit is disconnected or a power failure occurs only with this unit, data is recorded to other HDD unit in order to continue recording.
- HDD is very delicate. Handle the HDD with care and follow the precautions below because even a slight shock may damage the internal components of the HDD.
 - Do not drop the HDD. Also, do not put a metallic object such as a coin or a screw driver into the HDD tray.
 - Gently place the HDD on a cushion so that it is not subjected to shock.
 - Do not use an electric screwdriver. Vibrations and shocks caused by an electric screwdriver may damage the internal components of the HDD.
 - When replacing the HDD, do not knock the HDD with other components such as another HDD and the HDD tray.
 - Do not knock the HDD with tools such as a screwdriver when replacing the HDD.
- The following HDD has been tested and confirmed that the compatibility is ensured. This information is as of November 2007. Supply of this HDD may be stopped or it may be changed without notice by its manufacturer. Consult your dealer for the latest information or use of other HDDs. When you attach multiple HDDs, use the HDDs of the same capacity and the same model name, in principle.

<Hitachi Global Storage Technologies>
HDT725050VLA360 (500 GB, S-ATA)

Removing the HDD

Notice

- Make sure to turn the MAIN switch on the rear of this unit to OFF before attaching or removing the HDD.

Step 1 Push the left end of the screw covers on both sides of the cover to open.

Notice

- Do not leave the screw cover open for general use.

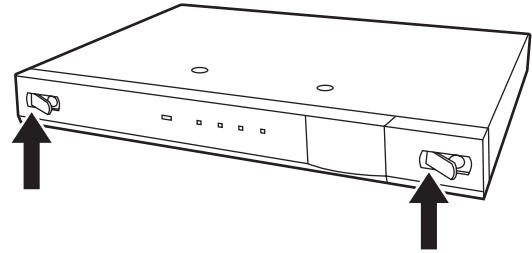

Step 2 Remove the screws.

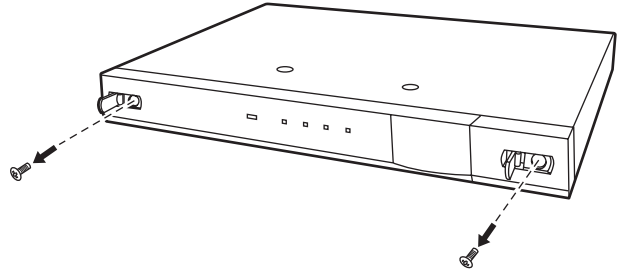

Step 3 Remove the front covers.

- Remove the cover on the right side first.
- Then, push the left cover to the right to remove.

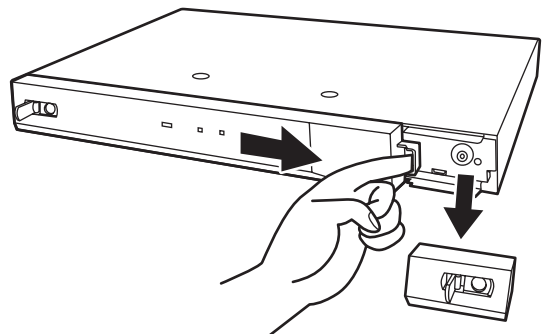

Step 4 Disconnect 2 cords connected to the circuit board on the metal part.

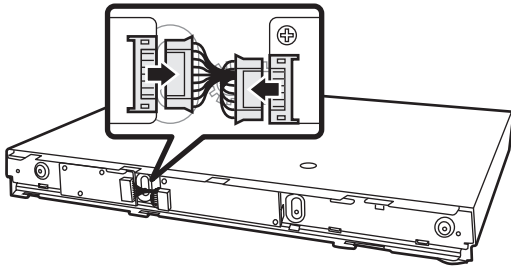

Step 5 Remove the metal part.
 • Remove 4 screws on the metal part.

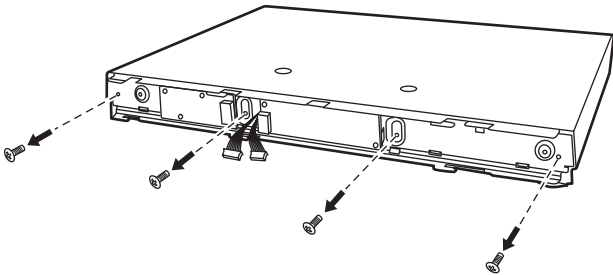

Step 6 Pull out the HDD tray halfway.

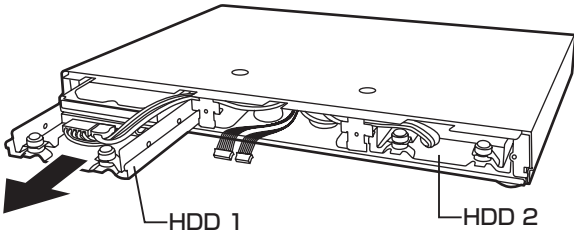

Step 7 Remove the cords.

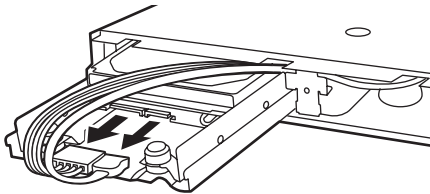

Step 8 Pull out the HDD tray.
 • Pull out the HDD tray completely.

Step 9 Remove the HDD.
 • Remove 4 screws securing the HDD and then remove the HDD from the frame.

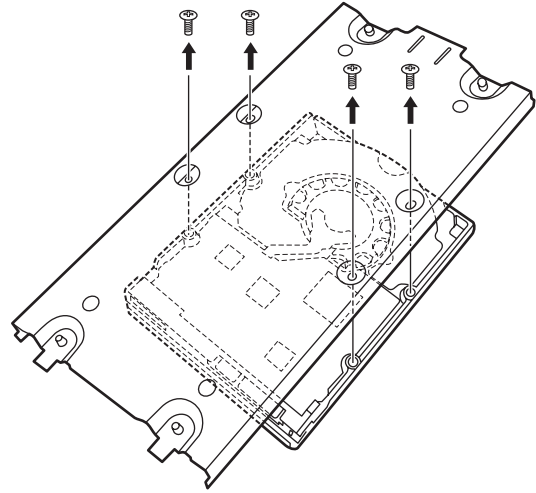

Notice

- Because S-ATA connectors of HDD are very delicate, connect or disconnect the cords gently without applying excessive force to the connectors.
 Take special care to connect or disconnect the connectors straight in order to prevent vertical force from being applied to them.

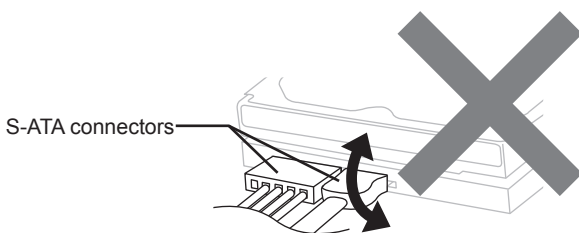

Replacing the HDD (continued)

Attaching the HDD

Notice

- When you attach multiple HDDs, attach them in the order of HDD 1 and 2.

Step 1 Attach the new HDD onto the HDD tray with 4 screws.

- Make sure to attach the HDD in the correct orientation.

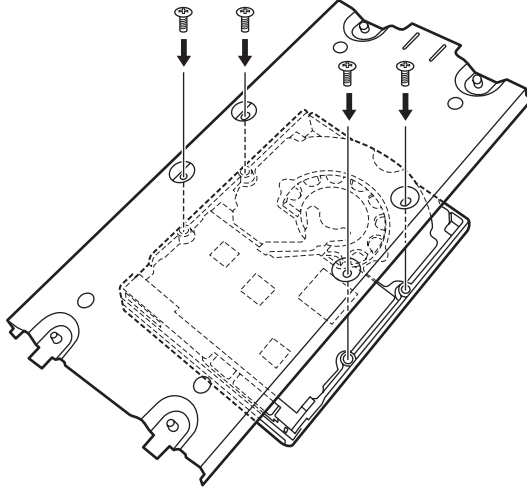

Notice

- When attaching the HDD to this unit, use the supplied screws.

Step 2 Insert the HDD tray halfway.

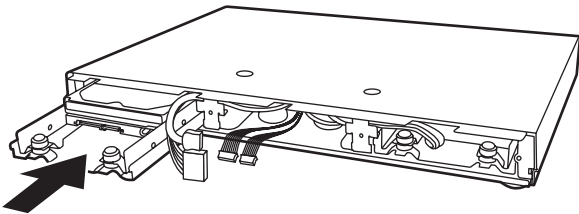

Step 3 Connect the cords.

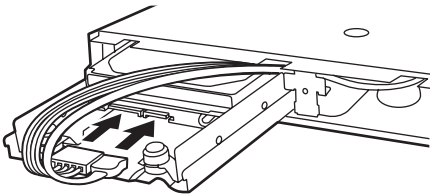

Step 4 Insert the HDD tray completely.

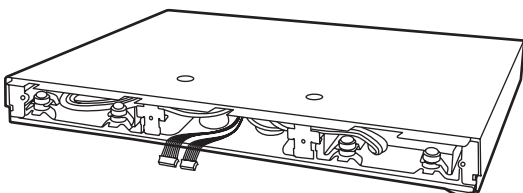

Step 5 Attach the metal part.

- Align the upper side first, then push the lower side into the unit.
- Take care not to deform the springs.
- Pass the cord to be connected to the circuit board through the hole in the metal part.

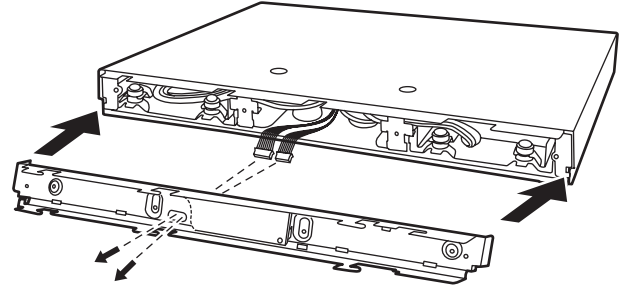

Step 6 Fix the metal part with 4 screws.

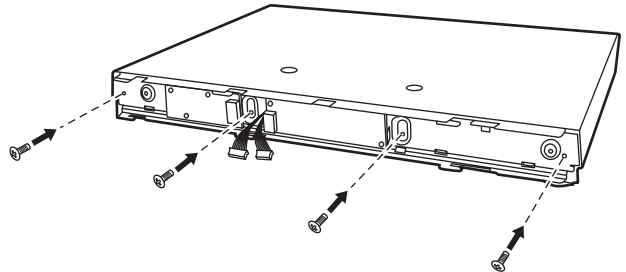

Step 7 Connect 2 cords to the circuit board on the metal part.

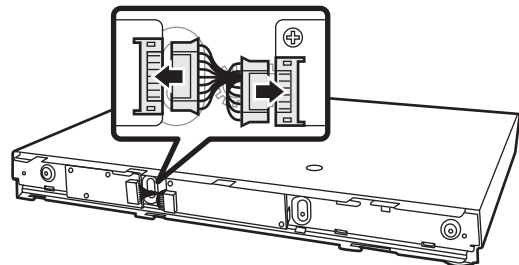

Step 8 Check whether the HDD is connected properly.

- 1 Set the MODE rotary switch to any number from 0 to 5.
- 2 While the TEST button is pressed, press the RESET button.
- 3 After the unit boots up and the buzzer sounds, press the TEST button.

The HDD test function is activated and tests each HDD for 1 minute, and then the test results are shown by the ACCESS indicator.

When the indicator illuminates green, the connection is completed successfully.

When the indicator blinks red, the HDD is not connected properly.

When the indicator illuminates red, the HDD is not identified properly.

Step 9 Attach the front covers.

- Attach the left cover first and push it to the left.
- Then, attach the right cover.

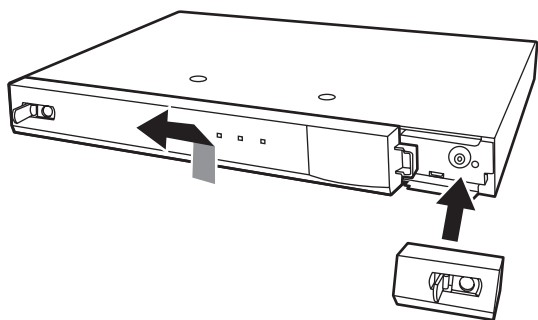

Step 10 Fix the front covers with 2 screws.

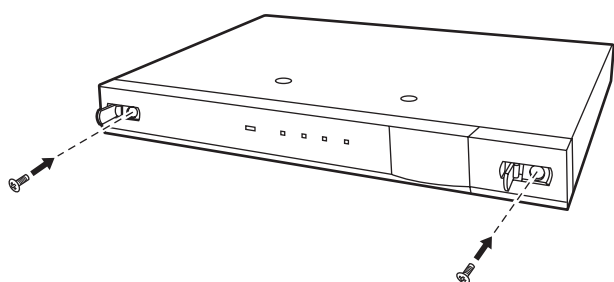

Step 11 Close the screw covers on both sides of the cover.

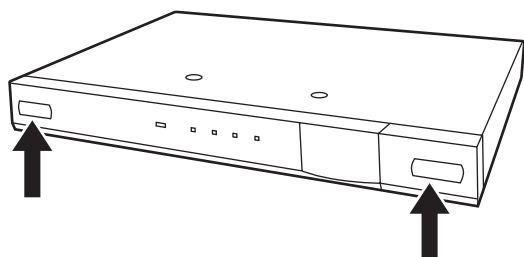

Tips

- Follow the same procedures to attach or remove HDD 2.

Troubleshooting

Diagnosis by HDD indicators

In the case that the HDD 1 or HDD 2 indicator on the front panel blinks or illuminates, check the problem in the HDD according to the chart below.

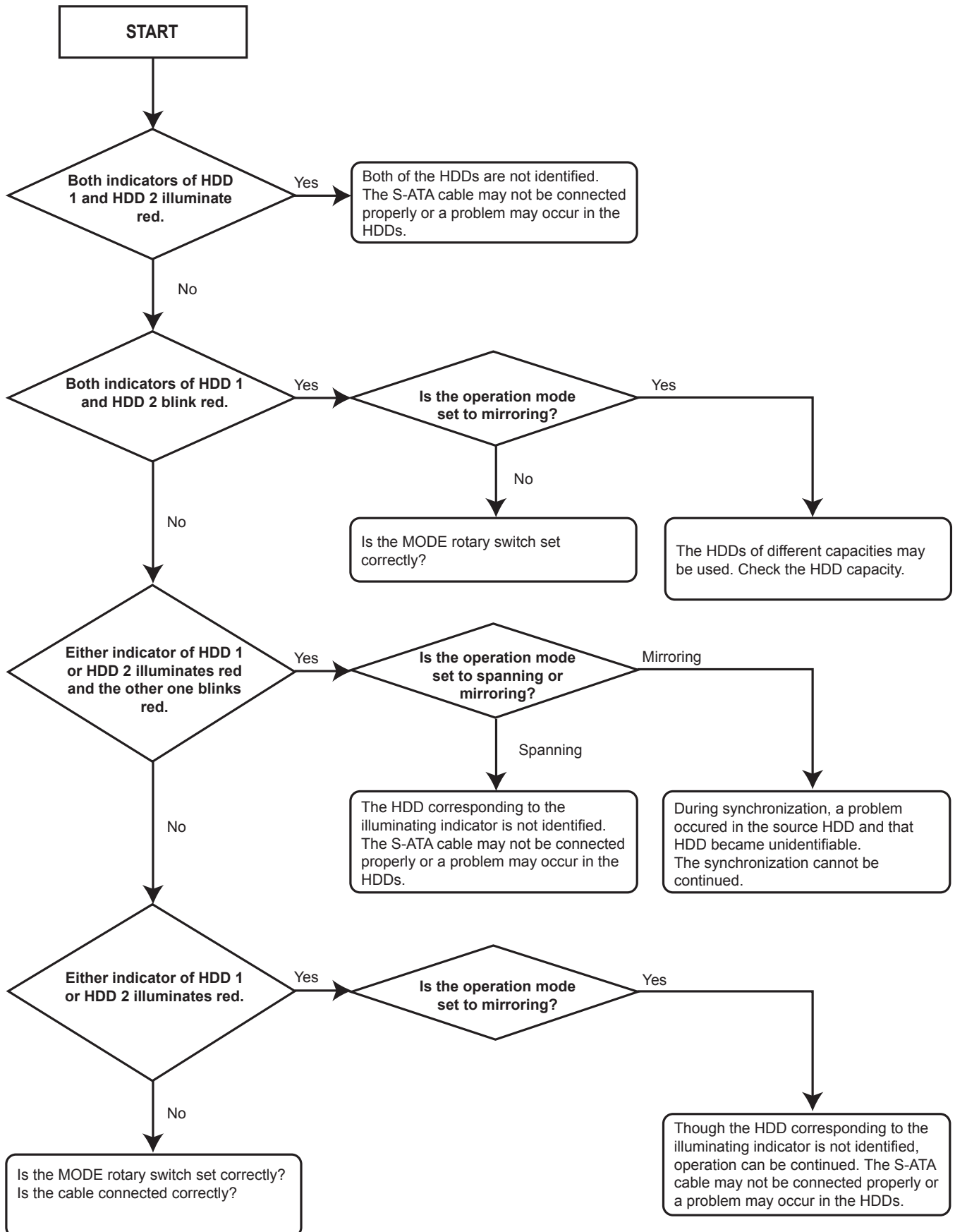

Troubleshooting

If problems with the unit persist even after you followed the suggestions below, please stop using the unit, disconnect the power cord and contact the retailer from whom you purchased the unit.

Description of problem	Please check the following
The unit does not turn on.	<ul style="list-style-type: none"> • Is the power cord properly plugged in? • Is the EXTERNAL CONTROL switch set to ON though the DC 12 V OUT terminal of the recorder and the CONT IN terminal of this unit are not connected ?
This unit does not work correctly.	<ul style="list-style-type: none"> • Is the USB cable connected correctly? • Are the menus set correctly in the recorder? • Is the number of recording devices connected within the limitation? • Does the HDD 1 or HDD 2 indicator blink or illuminate red? • Is the MODE rotary switch set correctly? • Is the information of this unit displayed on the menu for registering the device? Is the correct data capacity displayed? • Did you delete the management information before changing the HDD operation mode?
TEMP indicator illuminates.	<ul style="list-style-type: none"> • Turn off the power. Turn on the power again after the internal temperature drops.
FAN indicator illuminates.	<ul style="list-style-type: none"> • Replace the fan with a new one. Ask your dealer to replace the fan.

Maintenance

The elapsed operating time, which can be a guide to know the periodic maintenance timing, is available in the menu of the recorder. Refer to the manual of the recorder. The indication of the operating time of the recorder may vary from the actual operating time. It is recommended to use this indication just for your reference.

When this unit is registered as a Main device, the elapsed operating time of this unit is not displayed. (The elapsed operating time of the recorder connected with this unit is displayed.)

Specifications

General

Rated Power Supply:	100 to 240 V AC, 50/60 Hz
Rated Input:	0.75 - 0.4 A (100-240 V)
Operating Temperature:	41 °F-104 °F (5 °C to 40 °C)
Relative Humidity:	Max. 80 (%)
Altitude:	Max. 2000 (m)
Dimensions:	424 (Width) x 361 (Depth) x 49 (Height) (mm)
Weight:	6.3 kg (with 2 HDD mounted)

Control terminals

CONT IN	Input terminal linked with the power supply of the recorder
CONT OUT	Output terminal linked with the power supply of the recorder (CONT OUT is the through output of CONT IN.)
GND (Ground)	For grounding
TEMP ALM	Output terminal for detecting abnormal temperature (open collector output) Active: "Low" level voltage output, Max. current 7 mA DC. Non active: Open, Max. voltage 24 V DC.
FAN ALM	Output terminal for detecting fan error (open collector output) Active: "Low" level voltage output, Max. current 7 mA DC. Non active: Open, Max. voltage 24 V DC.
HDD ALM	Output terminal for detecting HDD error (open collector output) Active: "Low" level voltage output, Max. current 7 mA DC. Non active: Open, Max. voltage 24 V DC.
CONT IN	Reserved.
CONT OUT	Reserved.

EXTERNAL CONTROL:

When set to ON: Power is supplied to the HDD when 12V is applied to the input terminal linked with the power supply.
When set to OFF: Power is always supplied to the HDD.

Serial bus terminal

Serial bus terminal (2 terminals) (Only DX-ZD6UE is connectable.)

Accessories:	USB2.0 cable	1
	Control cable	1
	Screws	8
	User's manual (this manual)	1
	Power cord	3

Control input/output terminals and circuits

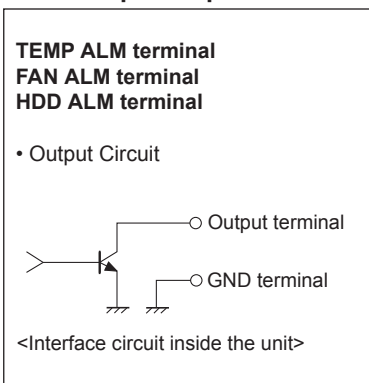

Design and specifications are subject to change without notice.

MITSUBISHI DIGITAL ELECTRONICS AMERICA, INC.

9351 Jeronimo Road, Irvine, CA 92618, U.S.A.

Phone 949-465-6000

www.mitsubishi-imaging.com

Tech Support 888-307-0309

tsupport@mdea.me.com

UK

Mitsubishi Electric Europe B.V.

UK Branch Office

Visual Information Systems Division

Travellers Lane Hatfield Herts AL10 8XB

Telephone: +44 (1707)-278 684

Fax: +44 (1707)-278 541

GERMANY

Mitsubishi Electric Europe B.V.

German Branch Office

Electric Visual Systems

Gothaer Str. 8 40880 Ratingen Germany

Telephone: +49 (2102)-486 9250

Fax: +49 (2102)-486 7320

SPAIN

Mitsubishi Electric Europe B.V.

Spanish Branch Office

Ctra. de Rubi, 76-80 Apdo.420

08190 Sant Cugat del Valles

(Barcelona) SPAIN

Telephone: +34 (93)-565 3154

Fax: +34 (93)-589 4388

FRANCE

Mitsubishi Electric Europe B.V.

French Branch Office 25,

Boulevard des Bouvets 92741 Nanterre
Cedex

Telephone: +33 (1)-5568 5500

Fax: +33 (1)-5568 5731

ITALY

Mitsubishi Electric Europe B.V.

Italian Branch Office

Centro Direzionale Colleoni

Palazzo Perseo - Ingresso 2, Via

Paracelso 12, 20041 Agrate Brianza, Italy

Telephone: +39 (039)-605 31

Fax: + 39 (039)-605 3214

The Netherlands

Mitsubishi Electric Benelux

A Division of Mitsubishi Electric Europe B.V.

Niiverheidsweg 23A, 3641 RP Mijdrecht

Netherlands.

Telephone: +31 (297)-282 461

Fax: +31 (297)-283 936

Sweden

Mitsubishi Electric Scandinavia

Hammarbacken 14 Box750 SE-191 27

Sollentuna

Sweden

Telephone: +46 (8)-625 1000

Fax: +46 (8)-35 1132

Ireland

Mitsubishi Electric Ireland

A Division of Mitsubishi Electric Europe B.V.

Westgate Business Park, Ballymount,
Dublin 24. Ireland

Telephone: +353 (1)-419 8800

Fax: +353 (1)-419 8895