

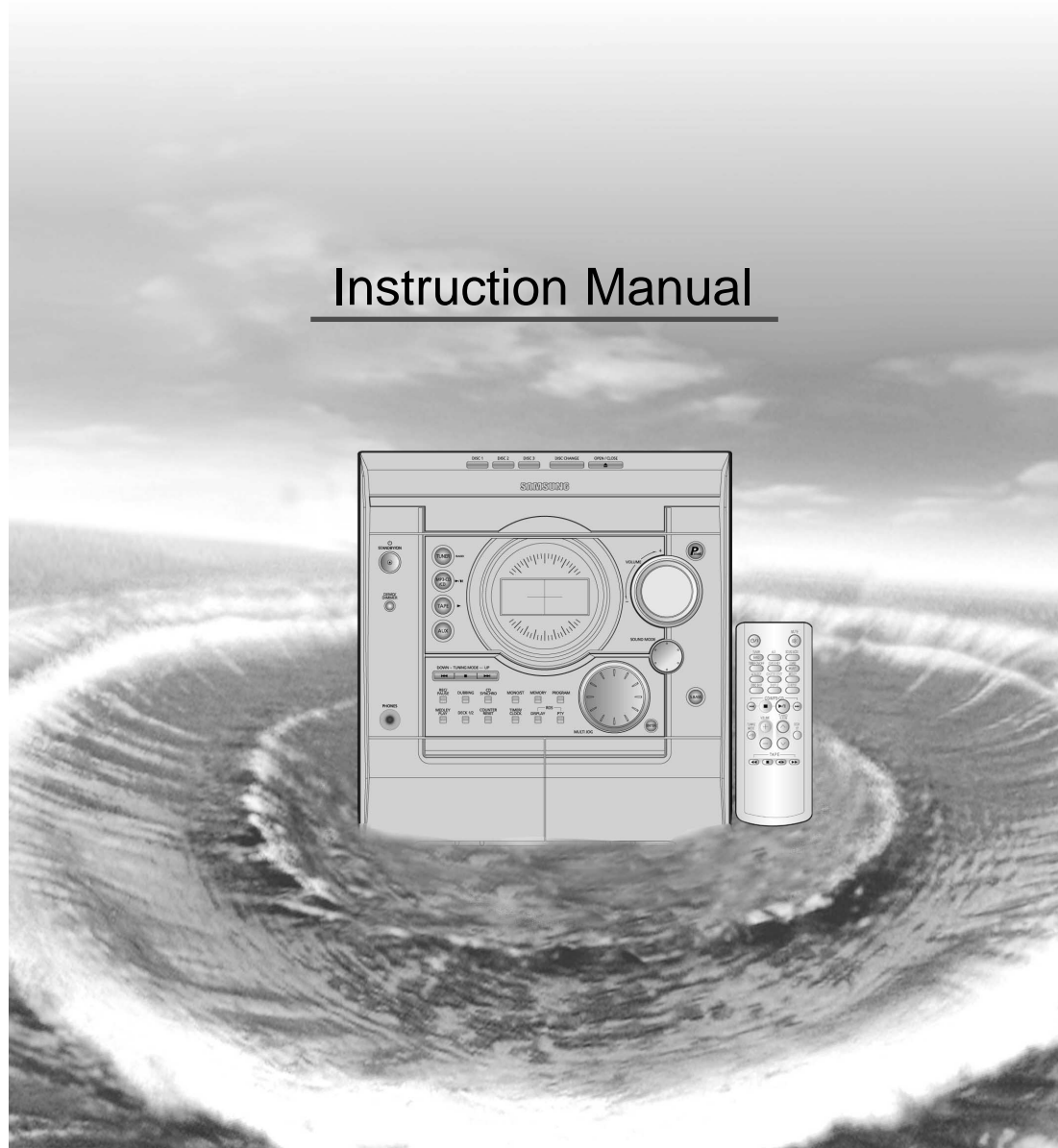

THREE-CD CHANGER  
MINI-COMPACT SYSTEM  
**MP3-CD/CD-R/RW PLAYBACK**  
MAX-ZJ550

Instruction Manual



## Safety Warnings



CLASS 1 LASER PRODUCT  
 KLASSE 1 LASER PRODUKT  
 LUOKAN 1 LASER LAITE  
 KLASS 1 LASER APPARAT  
 PRODUCTO LASER CLASE 1



CAUTION:  
 TO REDUCE THE RISK OF ELECTRIC SHOCK, DO NOT  
 REMOVE REAR COVER. NO USER SERVICEABLE  
 PARTS INSIDE. REFER SERVICING TO QUALIFIED  
 SERVICE PERSONNEL.

CLASS 1 LASER PRODUCT  
 This Compact Disc player is classified  
 as a CLASS 1 LASER product.

Use of controls, adjustments or performance of procedures other than those specified herein may result in hazardous radiation exposure.

### CAUTION-INVISIBLE LASER RADIATION WHEN OPEN AND INTERLOCKS DEFEATED, AVOID EXPOSURE TO BEAM.



This symbol indicates that dangerous voltage which can cause electric shock is present inside this unit.



This symbol alerts you to important operating and maintenance instructions accompanying the unit.

WARNING: To reduce the risk of fire or electric shock, do not expose this appliance to rain or moisture.

CAUTION: TO PREVENT ELECTRIC SHOCK, MATCH WIDE BLADE OF PLUG TO WIDE SLOT, FULLY INSERT.

## Wiring the Main Power Supply Plug(UK Only)

### IMPORTANT NOTICE

The main lead on this equipment is supplied with a moulded plug incorporating a fuse. The value of the fuse is indicated on the pin face of the plug and if it requires replacing, a fuse approved to BS1362 of the same rating must be used.

Never use the plug with the fuse cover removed. If the cover is detachable and a replacement is required, it must be of the same colour as the fuse fitted in the plug. Replacement covers are available from your dealer.

If the fitted plug is not suitable for the power points in your house or the cable is not long enough to reach a power point, you should obtain a suitable safety approved extension lead or consult your dealer for assistance.

However, if there is no alternative to cutting off the plug, remove the fuse and then safely dispose of the plug. Do not connect the plug to a main socket as there is a risk of shock hazard from the bared flexible cord.

Never attempt to insert bare wires directly into a main socket. A plug and fuse must be used at all times.

### IMPORTANT

The wires in the main lead are coloured in accordance with the following code:-

BLUE = NEUTRAL      BROWN = LIVE

As these colours may not correspond to the coloured markings identifying the terminals in your plug, proceed as follows:-

The wire coloured BLUE must be connected to the terminal marked with the letter N or coloured BLUE or BLACK.  
 The wire coloured BROWN must be connected to the terminal marked with the letter L or coloured BROWN or RED.

WARNING: DO NOT CONNECT EITHER WIRE TO THE EARTH TERMINAL WHICH IS MARKED WITH THE LETTER E OR BY THE EARTH SYMBOL , OR COLOURED GREEN OR GREEN AND YELLOW.

## Contents

Thank you for buying this  
 SAMSUNG mini-compact system.

Please take time to read these instructions.  
 They will allow you to operate your  
 system with ease and take full advantage  
 of its features.



◆ SAFETY WARNINGS .....	2
◆ INSTALLING YOUR MINI-COMPACT SYSTEM .....	4
■ Front Panel View .....	4
■ Display Window .....	4
■ Rear Panel View .....	5
■ Remote Control .....	5
■ Where to Install Your Mini-Compact System .....	6
■ Connecting your System to the Power Supply .....	6
■ Inserting Remote Control Batteries .....	6
■ Connecting the Loudspeakers .....	6
■ Connecting to an External Source .....	7
■ Connecting the AM (MW/LW) Aerial .....	7
■ Connecting the FM Aerial .....	7
■ Demo/Dimmer Function .....	8
■ Setting the Clock .....	8
◆ CD/MP3-CD-PLAYER .....	9
■ Loading and Changing Compact Discs .....	9
■ To reply the CD/MP3-CD .....	9
■ Selecting a CD in the Disc changer .....	10
■ Selecting a Track .....	10
■ To select the MP3-CD title and track .....	10
■ Searching for a Specific Music Passage on a CD .....	11
■ Shuffle Play Function .....	11
■ Medley Play .....	12
■ Repeating One or All Tracks on the Compact Discs .....	12
■ Function to skip through 10 track at a time .....	12
■ Last Memory Function .....	12
■ Programming the Order of CD Playback .....	13
■ Checking or Changing Programmed CD Tracks .....	14
◆ TUNER .....	14
■ Searching for and Storing the Radio Stations .....	15
■ Selecting a Stored Station .....	15
■ Improving Radio Reception .....	15
■ About RDS broadcasting .....	16
■ About RDS DISPLAY function .....	16
■ PTY (Program Type) indication and PTY-SEARCH function .....	17
◆ TAPE DECK .....	18
■ Listening to a Cassette .....	18
■ CD Synchro Record Feature .....	18
■ Recording a Compact Disc .....	18
■ Recording a Radio Program .....	19
■ Copying a Cassette (Dubbing) .....	19
■ Tape Counter .....	19
◆ OTHER FUNCTIONS .....	20
■ Timer Function .....	20
■ Cancelling the Timer .....	20
■ Mute Function .....	21
■ Selecting Sound Mode .....	21
■ Power Sound Function .....	21
■ Setting the System to Switch off Automatically .....	22
■ S.BASS Function .....	22
■ Connecting Headphones .....	22
◆ RECOMMENDATIONS FOR USE .....	23
■ Safety Precautions .....	23
■ Cleaning Your Mini-Compact System .....	23
■ Precautions When Using Compact Discs .....	24
■ Precautions When Using Audio Cassettes .....	24
■ Before Contacting the After-Sales Service .....	24
■ Technical Specifications .....	25



Press



Push

### Symbols



Important



Note

## Front Panel View

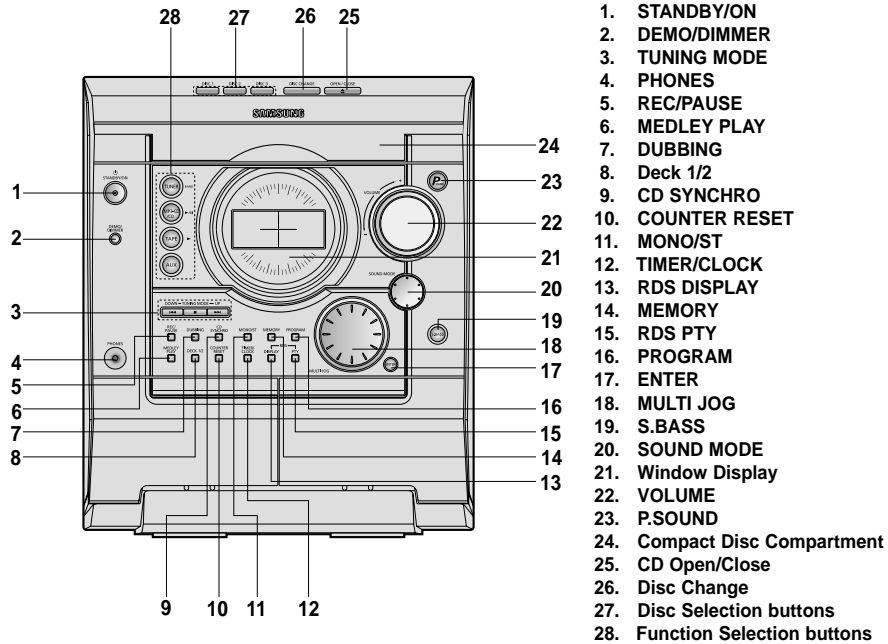

## Display Window

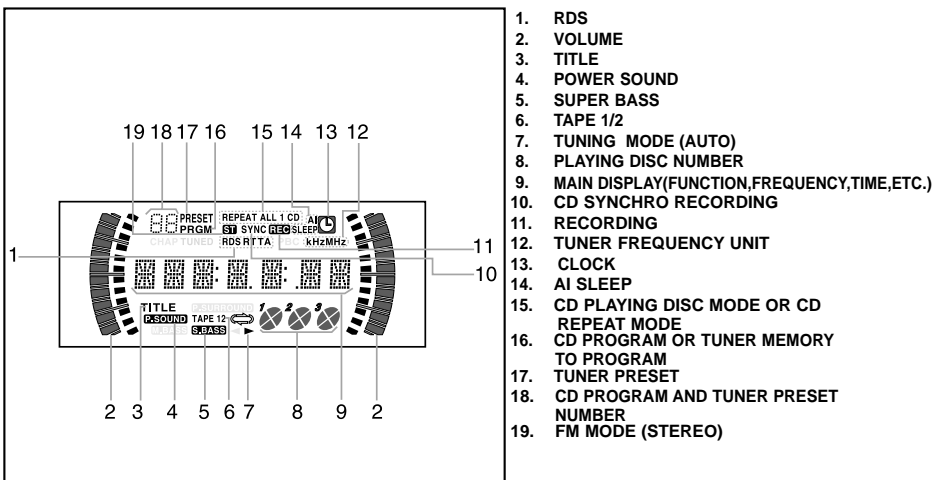

## Rear Panel View

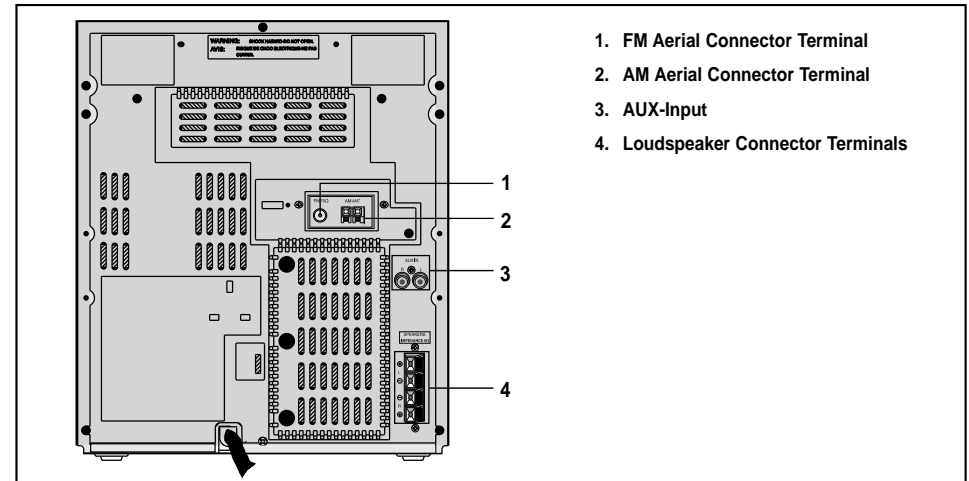

## Remote Control

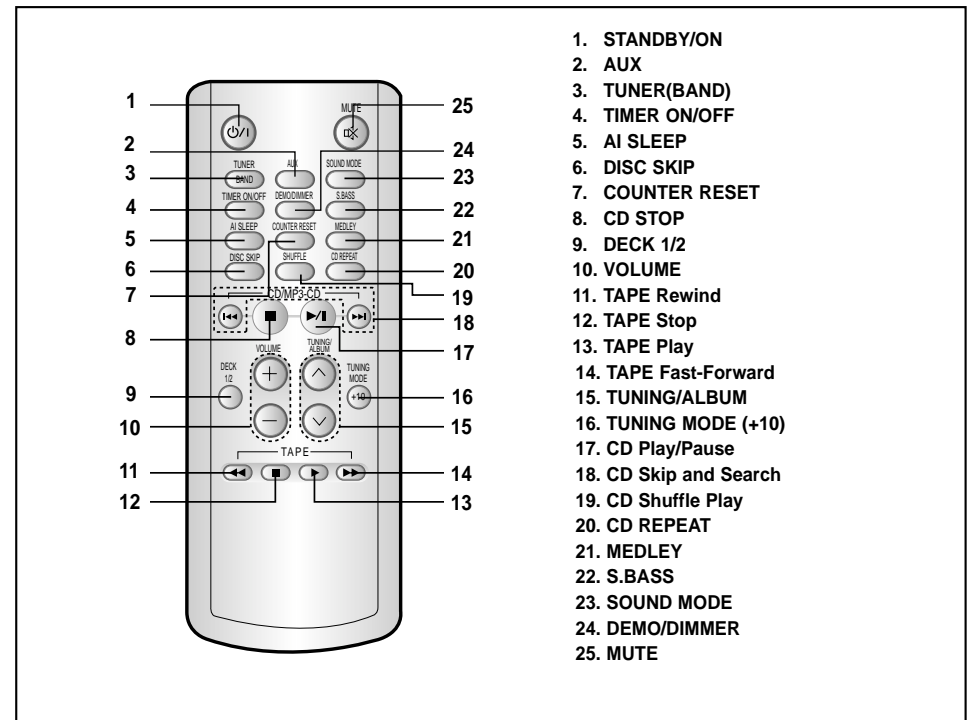

## Where to Install Your Mini-Compact System



To take full advantage of your new mini-compact system, follow these installation instructions before connecting the unit.

- ◆ Install the system on a flat, stable surface.
- ◆ Never place this unit on carpeting.
- ◆ Never place this unit in an outdoor area.
- ◆ Maintain an open space of approximately 6 inches (15 cm) on the sides and rear of the system, for ventilation purposes.
- ◆ Make sure that you have enough room to open the compact disc compartment easily.
- ◆ Place the loudspeakers at a reasonable distance on either side of the system to ensure good stereo sound.
- ◆ Direct the loudspeakers towards the listening area.
- ◆ For optimum performance, make sure that both speakers are placed at an equal distance above the floor.

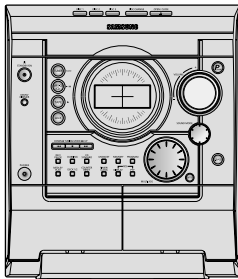

## Connecting your System to the Power Supply

The main lead must be plugged into an appropriate socket.

- ☛ Before plugging your system into a main socket, you must check the voltage.

- 1 Plug the main lead (AC cord on the rear of the system) into an appropriate socket.
- 2 Press the **STANDBY/ON** button to switch your mini-compact system on.

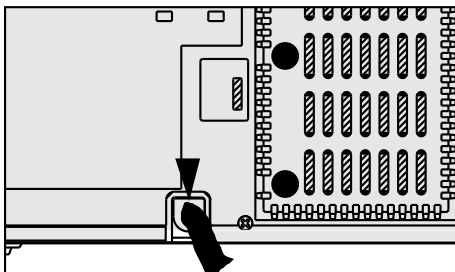

## Inserting Remote Control Batteries

Insert or replace remote control batteries when you:

- ◆ Purchase the mini-compact system
- ◆ Find that the remote control is no longer operating correctly

- ☛ When replacing the batteries, use a new set of batteries and never mix alkaline and manganese batteries.

- 1 Place your thumb on the position marked **PRESS** on the battery compartment cover (rear of the remote control) and push the cover in the direction of the arrow.
- 2 Insert two AAA, LR03 or equivalent batteries, taking care to respect the polarities:
  - ◆ + on the battery against + in the battery compartment
  - ◆ - on the battery against - in the battery compartment
- 3 Replace the cover by sliding it back until it clicks into position.

- If you will not be using the remote control for a long time, remove the batteries to prevent corrosion.

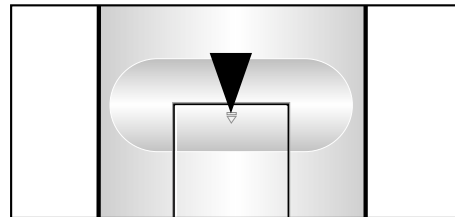

## Connecting the Loudspeakers

The loudspeaker connector terminals are located on the rear of the system.

There are four terminals on the system:

- ◆ Two for the left speaker (marked L)
- ◆ Two for the right speaker (marked R)

To achieve the correct sound quality, connect the:

- ◆ Red wire to the + terminals
- ◆ Black wire to the - terminals

- 1 Press and hold the terminal tab.
- 2 Insert the speaker cord.
- 3 Release the finger.

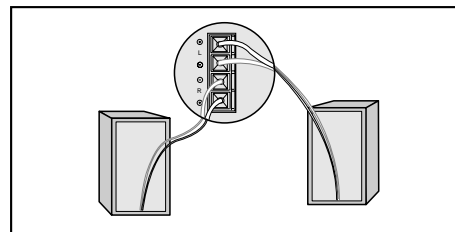

## Connecting to an External Source

The auxiliary input can be used to take advantage of the sound quality of your mini-compact system when listening to other sources.

- Examples:**
- ◆ A television
  - ◆ A video disc player
  - ◆ A Hi-Fi stereo video cassette recorder

- To connect to the external source, the source must have an audio output. In addition, you need an RCA connection cable.

- 1 Set the system to standby mode and disconnect it and the external source from the main socket.

- 2 Connect the audio cable to the rear of the mini-compact system.

**Connect the... To the connector marked...**

- Red jack ..... R (right)
- White jack ..... L (left)

- For optimum sound quality, do not invert the right and left channels.

- 3 Plug the system back into the main socket and press **STANDBY/ON** to switch it on.

- 4 Select the **AUX** source by pressing **AUX**.  
**Result:** **AUX** is displayed.

- 5 Switch the external source on.

- 6 Adjust the volume and balance as required:
  - ◆ Volume
  - ◆ Equalizer

**Example:** You can watch a film and take advantage of stereo sound provided that the original sound track is in stereo (as if you were in a cinema).

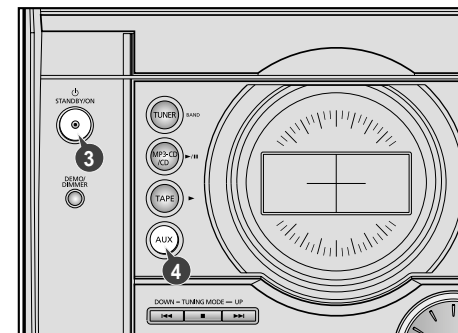
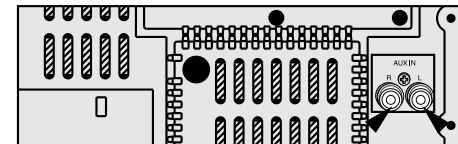

## Connecting the AM (MW)/LW Aerial



The AM aerial (for long and medium waves) can be:

- ◆ Placed on a stable surface
  - ◆ Fixed to the wall (you must first remove the base)
- The **AM** aerial connector terminals are located on the rear of the system and are marked **AM**.

- ☛ To avoid noise interference, check that the loudspeaker wires do not run close to the aerial wires. Always keep them at least 2 inches (5 cm) away.

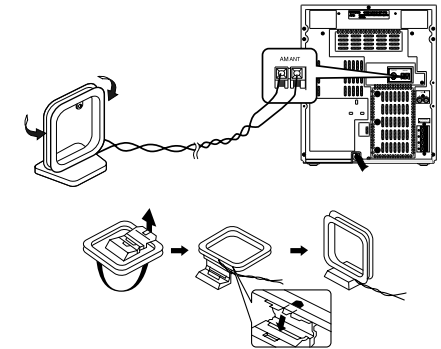

## Connecting the FM Aerial

How to connect a COAXIAL TYPE aerial.

- ◆ Connect a 75Ω antenna to the **FM** antenna terminal.
- ◆ Plug the connector on the **FM** aerial supplied into the coaxial socket (75Ω) marked **FM** on the rear of the system.
- ◆ Follow the instructions given on Page 14 to tune into a radio station, and determine the best position for the aerial.
- ◆ If reception is poor, you may need to install an outdoor aerial. To do so, connect an outdoor **FM** aerial to the **FM** socket on the rear of the system using a 75Ω coaxial cable (not supplied).

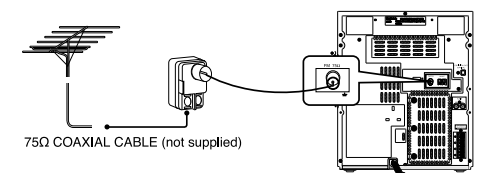
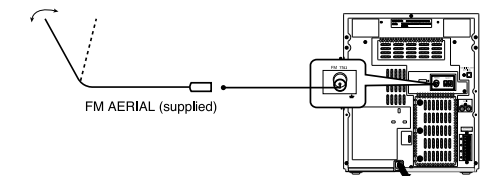

## DEMO/DIMMER function

All functions available on the system can be viewed on the display and the display's brightness can be switched between "on" and "off".

- 1 Press the **DEMO/DIMMER** button.  
**Result:** All functions available on the system appear on the front panel display.
- Each of these are explained in detail in this guide. Please refer to the relevant section.
- 2 Press the **DEMO/DIMMER** button again.  
**Result:** The Dimmer function is selected and the display darkens.
- 3 Press the **DEMO/DIMMER** button once again to brighten the front panel display.
- A display brightness control can only be performed while the system power is on.

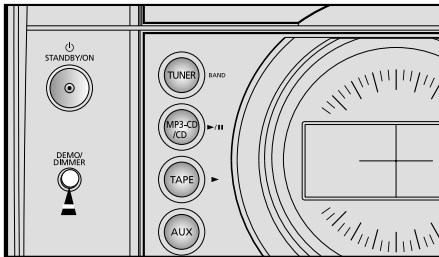

## Setting the Clock

Your system is equipped with a clock which allows you to turn your system on and off automatically. You should set the clock:

- ◆ When you first purchase the mini-compact system
  - ◆ After a power failure
  - ◆ After unplugging the unit
- For each step, you have a few seconds to set the required options. If you exceed this time, you must start again.
  - 1 Switch the system on by pressing **STANDBY/ON**.
  - 2 Press **TIMER/CLOCK** twice.  
**Result:** **CLOCK** is displayed.
  - 3 Press **ENTER**.  
**Result:** The hour flashes.
  - 4 **To... Turn the MULTI JOG knob to the...**  
Increase the hours ..... Right  
Decrease the hours ..... Left
  - 5 When the correct hour is displayed, press **ENTER**.  
**Result:** The minutes flash.
  - 6 **To... Turn the MULTI JOG knob to the...**  
Increase the minutes ..... Right  
Decrease the minutes ..... Left
  - 7 When the correct time is displayed, press **ENTER**.  
**Result:** The clock starts and is displayed, even when the system is in standby mode.
- You can display the time, even when you are using another function, by pressing **TIMER/CLOCK** once.
  - ◆ You can also use **◀▶** buttons on the panel front or **TUNING/ALBUM** **∨/∧** on the remote control to instead of **MULTI JOG** knob in step 4, 6.

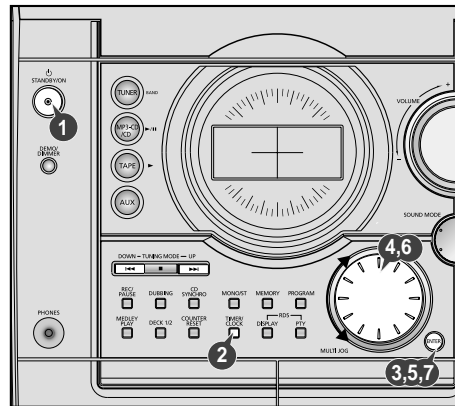

## Loading and Changing Compact Discs

The CD disc changer can contain up to three 12 cm or 8 cm compact discs without using an adapter.

- Never force the compact disc carousel when opening and closing the compartment.  
Never press down or place objects on the carousel.
  - Always treat your compact discs with care; refer, if necessary, to the section entitled "**Precautions When Using Compact Discs**" on page 24.
- 1 Switch the system on by pressing **STANDBY/ON**.
  - 2 Press the **OPEN/CLOSE** (▲) button on the front panel.  
**Result:** The compartment opens.
  - 3 Place one or two discs in the front slots of the carousel, with the label on the discs facing upwards.  
➤ Check that the compact disc has been correctly inserted in the holder before closing the compartment.
  - 4 If you wish to load a third compact disc, press the **DISC CHANGE** button on the front panel (or **DISC SKIP** on the remote control).  
**Result:** The carousel rotates by 120°.
  - 5 Close the compartment by pressing the **OPEN/CLOSE** (▲) button again.  
➤ If you wish to start playing a disc directly, you can also proceed as follows.

To play...	Press...
Disc 1 .....	MP3-CD/CD (▶/  ) or Disc 1
Disc 2 .....	Disc 2
Disc 3 .....	Disc 3

**Result:** The compartment closes automatically and the disc selected starts playing.

- 6 To change or unload the compact disc changer, repeat Steps 2 to 5.
  - Keep the compartment closed whenever you are not using it, to prevent dust from entering.
  - You can load or unload compact discs when the radio, tape or auxiliary source function is selected.

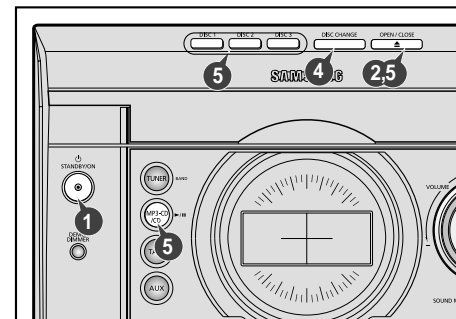

## To replay the CD/MP3-CD

This is a player that enables the playback of audio CD, CD-R, CD-RW and MP3-CD and does not possess the function that saves MP3 files.

Do not use CDs of irregular shapes like heart or octagon shapes. The performance of the player may be degraded.

At least more than one CD should be inserted for playbacks.

- 1 Press the **STANDBY/ON** button to switch on the power.
- 2 Press the **MP3-CD/CD** (▶/||) of the main unit to select the CD function.
- 3 Insert more than one CD or a MP3-CD.
- 4 Press the **MP3-CD/CD** (▶/||) button of the main unit or the **▶/||** button of the remote control.
  - If there are more than one CD or an MP3-CD inserted, replays are then processed in order.
  - ◆ Your CD Player will take a few moments to scan through all the tracks recorded on a particular MP3-CD.
  - ◆ The English name of the song may be indicated on the display only if directly downloaded from the PC or if the purchased MP3-CD is sorted according to titles(directory). (Other languages besides English may not be indicated.)
  - ◆ The English name of the track may not be indicated depending on the characteristics of the MP3-CD.

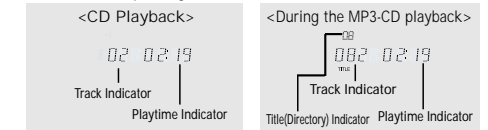

- 5 Adjust the volume according to needs with the following procedures.
  - ◆ Turn the **VOLUME** control of the main unit.
  - or
  - ◆ Press the **VOLUME +** or **-** button of the remote control.
- 6 If it is desired to pause while the playback is processing, press the **MP3-CD/CD** (▶/||) button.
  - Press the **MP3-CD/CD** (▶/||) button once again to playback again.
- 7 To stop playback, press the **■** button.
  - A new disc may be inserted in the remaining two compartments excluding the CD which is being played back. Press the **Disc Changer** button to open the CD tray. The revolving part does not turn during playbacks.
  - ◆ If there is not even one CD inserted in the CD tray, it is indicated as "**NO DISC**".
  - ◆ If the CD Repeat function is not selected, 3 CDs are played back which automatically stops.

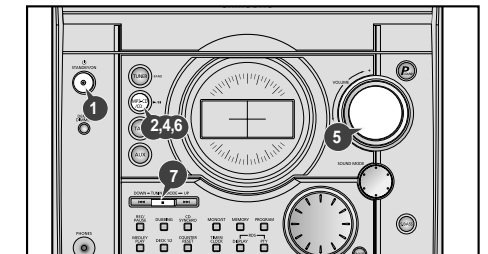

## Selecting a CD in the Disc changer

The CD function is automatically selected when Disc Skip is pushed.

To select a specific disc, press the corresponding DISC (1, 2, 3) button on the front panel or DISC SKIP on the remote control, until the required disc indicator flashes.

**Result:** All the discs will be played in turn, starting with the one selected.

- If you wish to play the current disc only, press CD REPEAT on the front panel one or more times, until 1 CD is displayed.
- If you use the DISC (1, 2, 3) function when listening to the radio or to a tape, the system switches automatically to the CD mode.
- ◆ If the disc selected is not loaded, the next disc is played automatically.
- ◆ When the CD door is opened, if you hold the OPEN/CLOSE button over 5 seconds until "LOCK" is on the display, the CD door will be locked. In the case, you should hold the OPEN/CLOSE button once again until "UNLOCK" is on the display, the CD door will be unlocked.

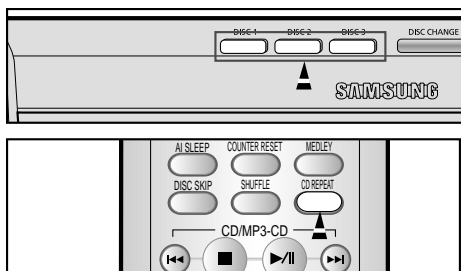

## Selecting a Track

You can select the track you wish to listen to, either when the compact disc player is stopped or when a disc is playing.

**To start playback at the beginning of the... Turn the MULTI JOG knob...**

- Next track ..... One notch to the right
- Current track ..... One notch to the left
- Previous track ..... Two notches to the left
- Track of your choice ..... The appropriate number of notches to the right or to the left

- You can also use the ⏮ and ⏭ buttons on the front panel, or the ⏮ and ⏭ buttons on the remote control to select a track.

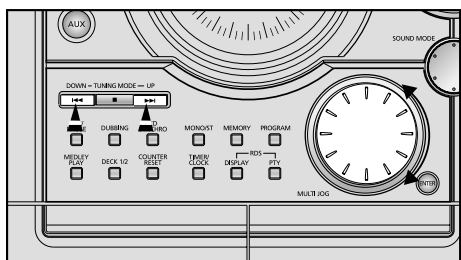

## To select the MP3-CD title and track

The title and track of the MP3-CD desired to listen may be selected on stopping or during playbacks.

### Main Unit

To move the title(Album), Turn the Multi Jog Knob.

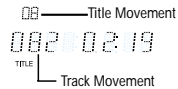

To move the track, press the ⏮, ⏭ button.

- ◆ Moves the track within the title.
- ◆ If the ⏮, ⏭ button is pressed more than the number of tracks within the title, it moves to the next title.

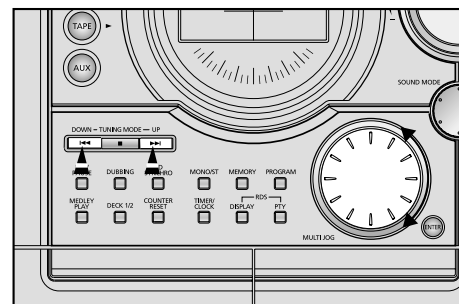

### Remote Control

Press the TUNING ALBUM ⏮ or ⏭ button, the title moves. Press the ⏮ or ⏭ buttons, the track moves.

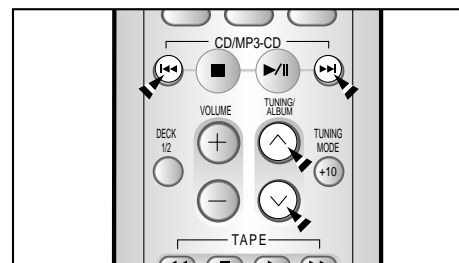

## What is MP3?

MP3 means MPEG1 Layer 3, the global standard for audio signal compression technology. It uses digital compression technology to compress original sound data by up to 12 times without sound quality degradation.

## File Compatibility

- ◆ The unit will playback files created in MP3 format (Mpeg1.Layer3) with \*.mp3 as their extension.
- ◆ Playback will be impossible for the file of MP2 or 22KHz.
- ◆ ID3\*tags cannot be shown on the display.
- \*An MP3 file can contain file information called "ID3 Tag" where its album name, performer, rack title, etc. are recorded.

## How many MP3 files can a CD-R or CD-RW disc record?

The maximum capacity of one CD-R or CD-RW disc is 680MB. Normally, one MP3 file has a capacity of 4MB, therefore approximately 170 files can be recorded on a single disc.

## Regarding the playback of CD-R/RW

- ◆ In the case of an original CD-R(Recordable) recorded in audio CD format, CD-RW(Rewritable) and editing by the user, playback is processed on the respective completed status. (The player may not be played back according to the characteristics of the CD or recorded status.)
- ◆ The CD-RW is comparably less reflexive than CD which causes more time delay to read.

## Playback sequence of titles and tracks

- ◆ In case of Window Explorer display.
- ◆ The arrows indicate playback sequence of titles and tracks.
- ◆ Tracks with jpg, wav or doc only are not audio files and therefore will be skipped.

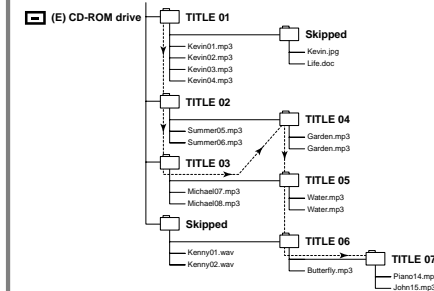

## Searching for a Specific Music Passage on a CD

When listening to a compact disc, you can quickly search for a specific music passage on a track.

- It is recommended that you turn the volume down before using this function.

To search through the tracks...	Press and hold down...
Forwards .....	⏭ for at least one second
Backwards .....	⏮ for at least one second

You can also press and hold down ⏮ / ⏭ on the front panel to auto search through the tracks.

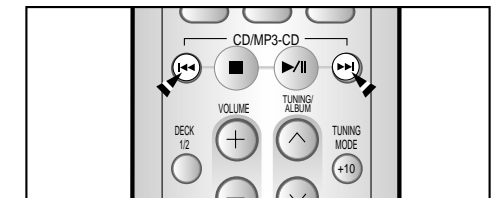

## Shuffle Play Function

You can listen to the tracks on a compact disc in a different order each time, as the various tracks will be selected automatically in a random sequence.

- 1 Press the SHUFFLE button.  
**Result:** The SHUFFLE (CD) or RANDOM (MP3-CD) indication appears and all the tracks are played in a random order. Both the track number and the playing time are displayed.
- 2 When playing tracks in a random order, you can:
  - ◆ Move on to the next track (selected at random) by pressing ⏮/⏭ or turning MULTI JOG one notch to the left or right.
  - ◆ Search quickly for a specific point in the current track by holding ⏮/⏭ more than one second.
- 3 To finish the random playback, press ■ or press the SHUFFLE button again.

- Repeat and CD Synchro function are not available in Shuffle playing mode.

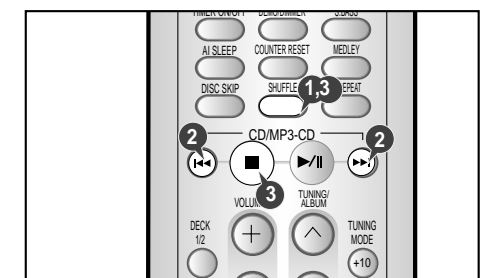

## Medley Play

(This function is only available during playback of a CD.)

You can select "MEDLEY ON" and "MEDLEY OFF" during playback of a CD.

- 1 Press the **MEDLEY PLAY** button once.  
Result: "MEDLEY" is displayed.  
◆ The interval time between the tracks can be shorten.
- 2 Press the **MEDLEY PLAY** button again.  
◆ Cancel this function, return to normal playback.

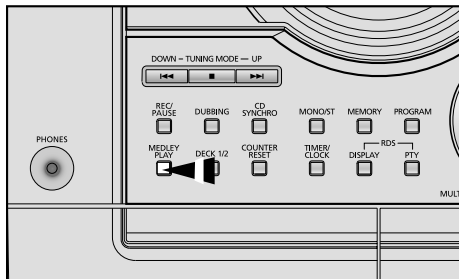

## Repeating One or All Tracks on the Compact Discs

You can repeat indefinitely:

- ◆ A specific track on a compact disc.
- ◆ All tracks on the compact disc selected.
- ◆ All discs loaded in the carrousel

- 1 To repeat... Press **CD REPEAT** on the Remote control once or more times until...

The current track indefinitely ..... **REPEAT 1** is displayed  
The selected disc ..... **REPEAT 1 CD** is displayed  
All discs loaded ..... **REPEAT ALL CD** is displayed

- 2 When you wish to stop the Repeat function, press **CD REPEAT** until **ALL CD** or **1 CD** is displayed, or press **■**.

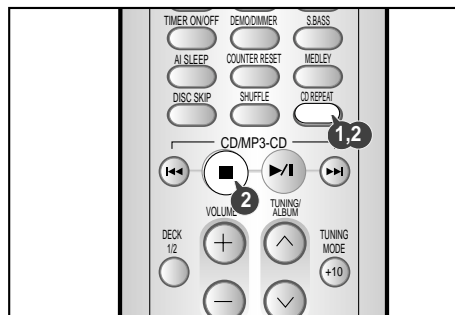

## Function to skip through 10 tracks at a time

Press the +10 button briefly while playing back a CD and MP3-CD. The track 10 tracks after the current one will then be played back.

Example: If you want to select track 43 during playback of track 5, press the +10 button four times, and then press the **▶▶** button three times.

5 → 10 → 20 → 30 → 40 → 41 → 42 → 43

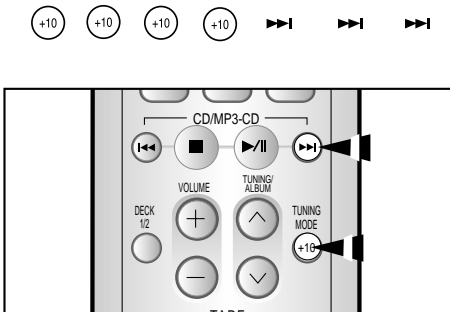

## Last Memory Function

(This function is only available during playback of MP3-CD.)

When MP3-CD playback is selected again after your CD player has been stopped or turned off, this function allows playback from the start of the track that you last listened to.

- ◆ Press the Program button while your MP3-CD is being played. The LAST ON and LAST OFF may be repeatedly selected.

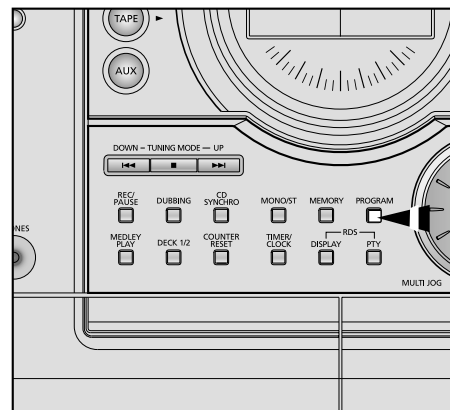

## Programming the Order of CD Playback

(This function is not available during playback of an MP3-CD.)

You can decide:

- ◆ The order in which you listen to the tracks on the discs loaded
- ◆ Which tracks you do not wish to listen to
- ▶ You can program up to 24 tracks.
- ◆ You must stop the compact disc player before selecting the tracks.
- ◆ This feature can be combined with the Repeat function.

- 1 If the CD function is selected, stop the player by pressing **■**.
- 2 Load the selected CDs.
- 3 Press **PROGRAM**.  
Result: The following indications are displayed:  
 (01 = Program no., DI = Disc no., -- = Track no. on the disc)
- 4 If necessary, select the disc containing the required track by pressing the corresponding **DISC (1, 2, 3)** button.
- 5 Select the required track by turning the **MULTI JOG** knob:  
◆ To the left to move back through the tracks  
◆ To the right to move forward through the tracks
- 6 Press **PROGRAM** to confirm your selection.  
Result: The selection is stored and is displayed.
- 7 To select other tracks, repeat Steps 4 to 6.
- 8 Press **MP3-CD/CD (▶▶)** to listen to the track selection in the order programmed.
- 9 To... Turn the **MULTI JOG knob...**  
Listen to the current track again ..... One notch to the left  
Listen to the previous track ..... Two notches to the left  
Listen to the next track ..... One notch to the right  
Skip forwards or backwards one ..... The appropriate number of notches to the right or to the left
- 10 To cancel the selection, press **■**.  
◆ Once if the compact disc player is stopped  
Result: **PRGM** is no longer displayed.

- ▶ If you open the compartment, the selection is cancelled.
- ◆ If you select the number of a disc which is not loaded or a track which does not exist on the CD, the selection skips to the next programmed track.
- ◆ You can also use the **◀◀** **▶▶** buttons to select the required tracks in step 5, 9.

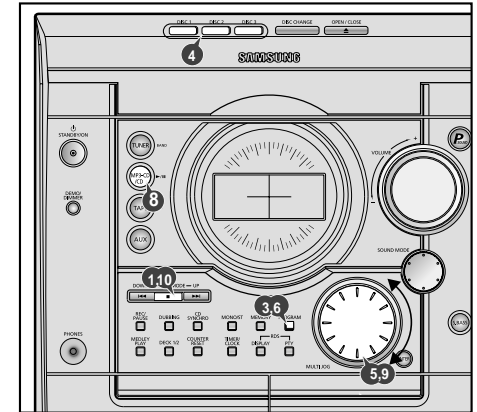

## Checking or Changing Programmed CD Tracks



You can check or change your selection of tracks at any time.

- Press **PROGRAM** once if you have started listening to the selection.
- Press **PROGRAM**.  
Result: The following indications are displayed:  
  
(CH = Check, 01=Program No, DI = Disc No, -- = Track No on the disc)  
➤ If you have already programmed 24 tracks, **CH** is displayed instead of **PR** when you press **PROGRAM**.
- Press **PROGRAM** again.  
Result: The first track selected is displayed, together with the letter **CH** (Change).
- Press **PROGRAM** once or more times until the track to be changed is displayed.
- If necessary, press the corresponding Disc (1, 2, 3) button to change discs.
- Press **◀▶** and **▶▶** or turn **MULTI JOG** to select a different track.
- Press **PROGRAM** to confirm your change.
- Press **MP3-CD/CD (▶||)** to start listening to the selection.  
Result: The first track selected is played.

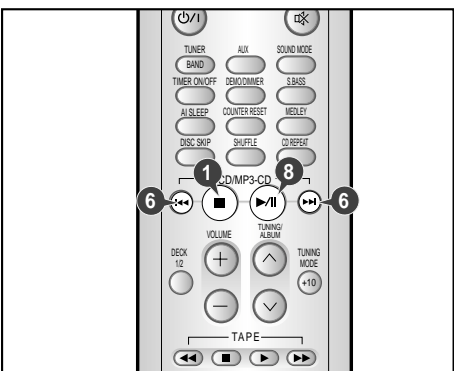
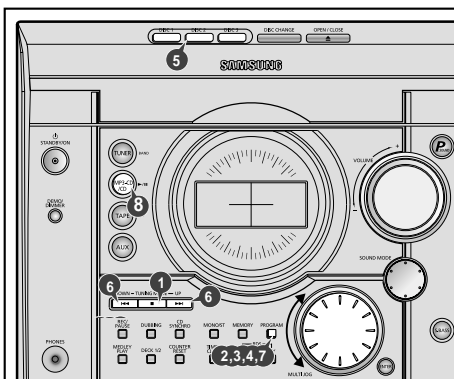

## Searching for and Storing the Radio Stations

You can store up to:

- ◆ 15 FM stations
- ◆ 8 MW stations
- ◆ 7 LW stations

- Switch the system on by pressing **STANDBY/ON**.
  - Select the **TUNER** function by pressing **TUNER**.
  - Select the required frequency band by pressing **TUNER (Band)** again on the front panel or **TUNER (Band)** on the remote control.  
Result: The appropriate indication is displayed:  
◆ **FM** Frequency Modulation  
◆ **AM(MW)** Medium Wave  
◆ **LW** Long Wave
  - To search for a station... Press **TUNING MODE**  
Manually ..... Once or more times until **MANUAL** is displayed.  
Automatically ..... Once or more times until **AUTO** is displayed.
  - Select the station to be stored by:  
◆ Turning the **MULTI JOG** knob to the right or to the left to increase or decrease the frequency respectively  
or  
◆ Pressing **TUNING** **∨** or **∧** on the remote control  
◆ To scroll through the frequencies faster when searching manually, hold down the **TUNING** **∨** or **∧** buttons.  
◆ The automatic search procedure may stop on a frequency that does not correspond to a radio station. If this happens, use the manual search mode.
  - Adjust the volume by:  
◆ Turning the **VOLUME** knob on the front panel  
or  
◆ Pressing the **VOLUME +** or **-** buttons on the remote control
  - Select the FM stereo or mono mode by pressing **MONO/ST**.
  - If you do not want to store the radio station found, revert to Step 4 and search for another station.  
Otherwise:  
a Press **MEMORY**.  
Result: The **PRGM** is displayed for a few seconds.  
b Press **TUNING** **∨** or **∧** to assign a program number .  
c Press **MEMORY** to store the radio station.  
Result: **PRGM** is no longer flashed and the station is stored.
  - To store any other radio frequencies required, repeat Steps 3 to 8.
- ◆ The **PROGRAM** function can be used to assign a new station to an existing program number.

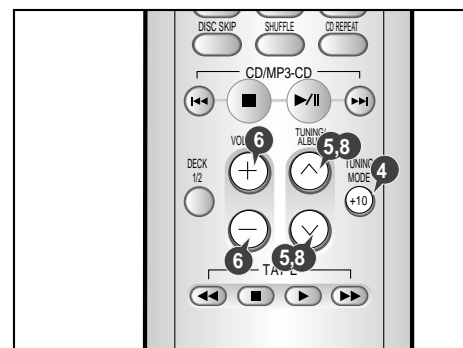
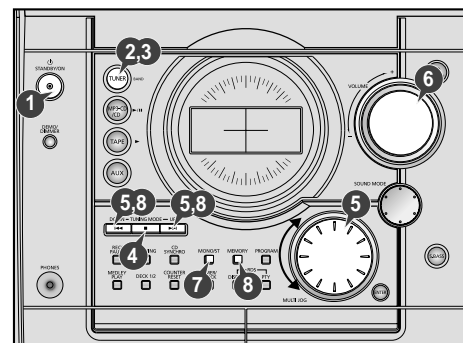

### In Tuner mode

- ◆ In manual tuning mode, you can use **MULTI JOG** or **◀▶** button on the panel front to manual search a radio station.
- ◆ During Tuner auto searching, press **■** button to stop auto searching.
- ◆ In Preset tuning mode, you can use **MULTI JOG** or **◀▶** button on the panel front to search a stored radio station.

## Selecting a Stored Station



You can listen to a stored radio station as follows:

- Switch the system on by pressing **STANDBY/ON**.
- Select the **TUNER** function by pressing **TUNER** on remote control.
- Select the required frequency band by pressing **TUNER (BAND)** on the remote control or **TUNER (BAND)** again on the front panel.
- Press the **TUNING MODE** button on the front panel of the unit, or the **TUNING MODE** button on the remote control until "**PRESET**" is displayed.
- Turning **MULTI JOG** on the front panel left or right until the desired station is found or press **◀▶** to select the desired station.  
or  
Select the desired station by pressing the **TUNING / ALBUM** **∨** or **∧** button on the remote control.  
Result: The desired station is now received.

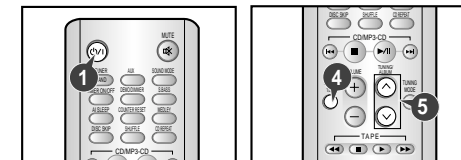
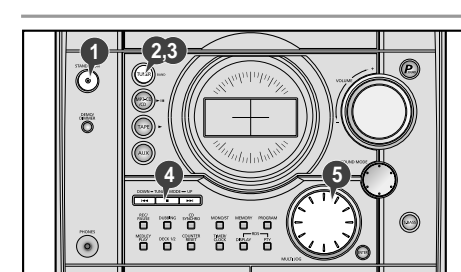

## Improving Radio Reception

You can improve the quality of radio reception by:

- ◆ Rotating the FM or AM(MW) aerial
  - ◆ Testing the positions of the FM and AM(MW) aeriels before fixing them permanently
- If reception from a specific FM radio station is poor, press **MONO/ST** to switch from stereo mode to mono. The quality of the sound will be improved.

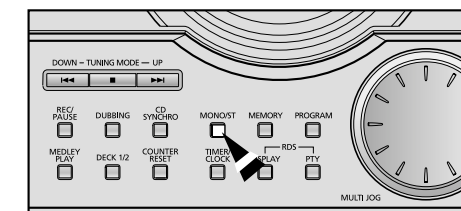



## About RDS broadcasting

This unit has the RDS (Radio Data System) function, which enables for the various information such as broadcasting station, radio text, time and 30 types of programs (News, Rock, Classic, etc.) to be received from the FM RDS station together with normal radio signal.

- 1 Press the **STANDBY/ON** button.
- 2 Receive the **FM** radio.
  - ◆ See the radio receiving method on the **page 14**.
  - ◆ **FM** and frequency are shown on the display
  - ◆ If the received station transfers the RDS information, 'RDS' appears automatically on the display.
- 3 Press the **RDS DISPLAY** button to select the desired RDS mode.
  - ◆ Whenever the button is pressed, RDS mode changes as follows.

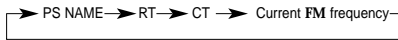

◆ The RDS function is available only in **FM** broadcasting.

➤ Description on RDS function

1. **PTY (Program Type)** : Displays the type of programme currently being broadcast
2. **PS NAME (Program Service Name)** : Indicates the name of broadcasting station and is composed of 8 characters.
3. **RT (Radio Text)** : Decodes the text broadcast by a station (if any) and is composed of maximum 64 characters.
4. **CT (Clock Time)** : Decodes the real time clock from the **FM** frequency.
  - Some stations may not transmit PTY, RT or CT information therefore this may not be displayed in all cases.
5. **TA (Traffic Announcement)** : When this symbol flashes it shows that the traffic announcement is in progress.

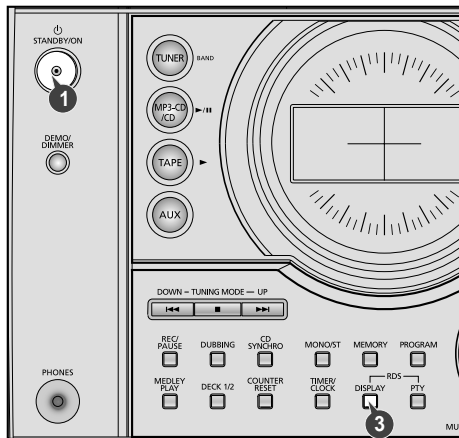

## About RDS DISPLAY function

About "PS NAME" MODE

➤ Displays the name of broadcasting station.

Press the **RDS DISPLAY** button to select the PS NAME.

- ◆ "**PS NAME**" appears on the display.
- ◆ If the PS information is being received, the PS name (BBC, AFO, NDR, etc.) is shown on the display.
- ◆ If the PS information isn't received, the original **FM** frequency is shown.

➤ Even though no RDS DISPLAY button is pressed, the reception of PS information ensures the PS name is displayed.

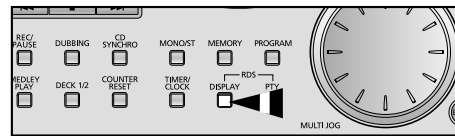

About 'RT' MODE

➤ Displays the character transmitted from the broadcasting station.

Press the **RDS DISPLAY** button to select the RT MODE.

- ◆ "**RT**" appears on the display.
- ◆ If the RT information is being received, the received information is shown on the display.
- ◆ If the RT information isn't received, the "**NO RT**" is shown on the display.

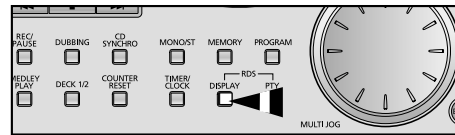

About CT(Clock Time)

➤ Sets the time of RDS clock.

To select the CT time, set the RDS Display button to CT MODE.

- ◆ The CT information will take up to 2 minutes to be decoded therefore the clock isn't displayed immediately.
- ◆ If there is no received CT information, "**NO CT**" is displayed.

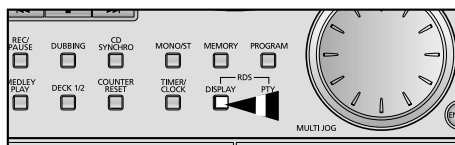

## PTY (Program Type) indication and PTY-SEARCH function

- ◆ The PTY information is composed of an identification symbol, which helps the **FM** radio to recognize the program type of each **FM** station.
- ◆ The 30 PTY modes are shown on the display by pressing the PTY button.

Display	Program Type
<b>NEWS</b>	• News including an announced opinion and report
<b>AFFAIRS</b>	• Several matters including a current incident, documentary, discussion and analysis.
<b>INFO</b>	• Information including weights and measures, returns and forecast, matters interesting the customer, medical information, etc.
<b>SPORT</b>	• Sports
<b>EDUCATE</b>	• Education
<b>DRAMA</b>	• Drama-Radio serial, etc.
<b>CULTURE</b>	• Culture-National or local culture including the religious problem, social science, language, theater, etc.
<b>SCIENCE</b>	• Natural science and technology
<b>VARIED</b>	• Others-Speech, amusing program (quiz, game), interview, comedy and satirical play, etc.
<b>POP M</b>	• Pop Music
<b>ROCK M</b>	• Rock Music
<b>M.O.R.M</b>	• M.O.R- Comfortable music, occasionally vocal or piece
<b>LIGHT M</b>	• Light classical music- Classical music and instrumental and chorus music
<b>CLASSICS</b>	• Heavy classical music-Orchestra music, symphony, chamber music and opera
<b>OTHER M</b>	• Other music - Jazz, R&B country music
<b>WEATHER</b>	• Weather
<b>FINANCE</b>	• Finance
<b>CHILDREN</b>	• Children's programmes
<b>SOCIAL</b>	• Social affairs
<b>RELIGION</b>	• Religion
<b>PHONE IN</b>	• Phone in
<b>TRAVEL</b>	• Travel
<b>LEISURE</b>	• Leisure
<b>JAZZ</b>	• Jazz Music
<b>COUNTRY</b>	• Country Music
<b>NATION M</b>	• National Music
<b>OLDIES</b>	• Oldies Music
<b>FOLK M</b>	• Folk Music
<b>DOCUMENT</b>	• Documentary
<b>TEST</b>	• Alarm Test

About PTY-SEARCH

- 1 Tuned to an **FM** station broadcasting a PTY MODE.
    - ◆ See the **FM** receiving method on the **page 14**.
    - ◆ If the received station is transmitting the RDS information, "RDS" lights up.
  - 2 Press the **PTY** button.
    - ◆ The **PTY MODE**(NEWS, AFFAIRS, etc) appears on the display.
    - ◆ Press the **TUNING Down** or **Up** button to select the desired PTY MODE.
- 
- ◆ If the station is transmitting no **PTY** information, '**NO PTY**' shows on the display.
  - ◆ When the **PTY MODE** is selected(The **PTY MODE** is shown in the display), press the **PTY** button once again to convert into **PTY-SEARCH MODE** and auto-search the station sequentially.
  - ◆ If a station is found broadcasting required **PTY MODE** then the search station and the stop is selected.
- 
- ◆ If the **PTY MODE** isn't found, it is retuned to the original station frequency at beginning the **PTY SEARCH** and auto-search and **PTY SEARCH** are suspended.

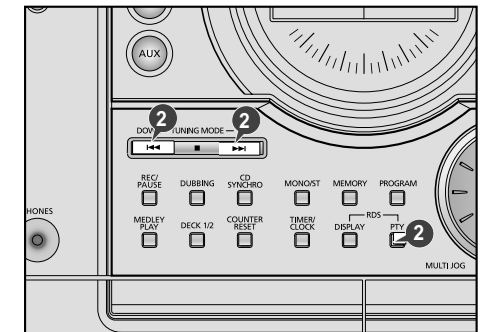

## Listening to a Cassette

- Always treat your cassettes with care; refer, if necessary, to the section entitled "Precautions When Using Audio Cassettes" on page 24.

- Switch the system on by pressing the **STANDBY/ON** button.
- Select the **TAPE** function by pressing **TAPE** on the front panel.
- Open either cassette deck 1 or 2 by pushing and releasing the deck cover where **PUSHE JECT** (▲) is written.
- Insert the pre-recorded cassette with the open edge of the tape facing downward.
- Close the deck by pushing on it until it clicks into place. **Result:** Depending on the deck selected, the 1 or 2 indication is displayed in front of the counter number.

- If you have inserted two cassettes, press **DECK 1/2** on the front panel or directly the **DECK 1/2** button on the remote control to select the cassette to be played.

**Result:** Depending on the deck selected, the TAPE 1 or TAPE 2 indication is displayed.

### To listen to... Press ...

Side A,B .....TAPE (▶)

**Result:** The cassette starts playing.

- When the cassette is stopped, select one of the following functions as required or on the remote control.

### Main Unit

To...	Press...
Rewind the cassette .....	◀◀
Fast-forward the cassette .....	▶▶

### Remote Control

To...	Press ...
Rewind the cassette .....	◀◀
Fast-forward the cassette .....	▶▶

- To stop the playback .....

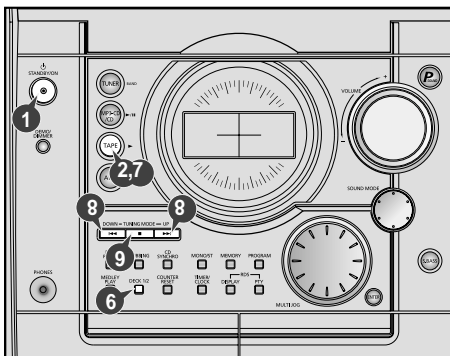

## CD Synchro Record Feature

(This function is not available during playback of an MP3-CD.)

You can record a compact disc on a cassette in two different ways:

- Synchronised recording
- Direct recording

This feature enables you to synchronize the start of the recording with the start of the disc or track of your choice.

- Switch the system on by pressing **STANDBY/ON**.
- Insert a blank cassette in Deck 2.
- Select the **CD** function by pressing **MP3-CD/CD** on the front panel.
- Load a compact disc.
- Select the required disc.
- Select the required track and press **CD SYNCHRO** or press **CD SYNCHRO** directly to start recording at the beginning of the disc. **Result:** **REC** and **CD SYNC** are displayed and recording starts.
- To stop recording, press ■.

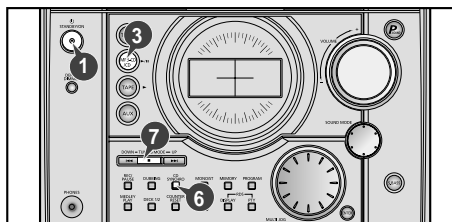

## Recording a Compact Disc

The direct recording mode enables you to start recording with any track on the compact disc.

- You can only record on cassettes in Deck 2.
- You do not need to adjust the volume, as it has no effect on the recording.

- Switch your system on by pressing **STANDBY/ON**.
- Insert a blank cassette in Deck 2.
- Select the **CD** function by pressing **MP3-CD/CD** on the front panel.
- Load the compact disc.
- Select the required disc.
- Select the required track on the compact disc and press **▶/II** on the front panel or **▶/II** on the remote control to set the compact disc player to Pause mode.
- Press the **REC/PAUSE**. **Result:** **REC** is displayed.
- Press the **▶/II** to start playing the track. **Result:** The track is recorded on the cassette.
- To stop recording, press ■.

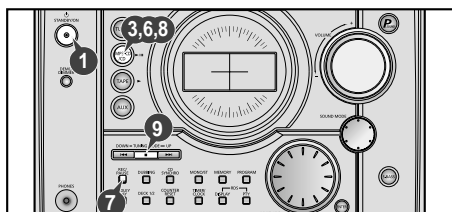

## Recording a Radio Program

You can record a radio program of your choice.

- You can only record on cassettes in Deck 2.
- You do not need to adjust the volume, as it has no effect on the recording.

- Switch the system on by pressing **STANDBY/ON**.
- Insert a blank cassette in Deck 2.
- Select the **TUNER** function by pressing **TUNER**.
- Select the radio station that you wish to record by pressing **Tuning** ^ or v on the remote control or by press the **Tuning Down** or **Up** on the front panel.
- Press **REC/PAUSE**. **Result:** **REC** is displayed in red and recording starts.
- To stop recording, press ■.

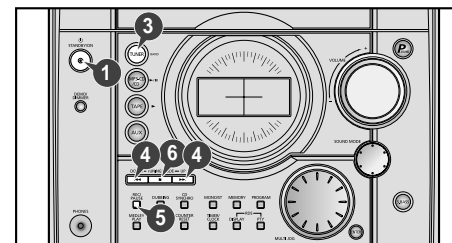

## Copying a Cassette (Dubbing)

You can copy a cassette from Deck 1 to Deck 2.

- Normal speed dubbing in selecting Tape function mode.

- You do not need to adjust the volume, as it has no effect on the recording.
- Take care not to insert the tape to be copied in Deck 2, as it will be erased when you start recording.

- Switch your system on by pressing **STANDBY/ON**.
  - Insert a blank cassette in Deck 2.
  - Insert the tape to be copied in Deck 1.
  - To copy a cassette at... Press...**  
Normal speed .....DUBBING
- Result:** The appropriate indications are displayed and the cassette in Deck 1 is copied to the cassette in Deck 2.
- To stop dubbing, press ■.

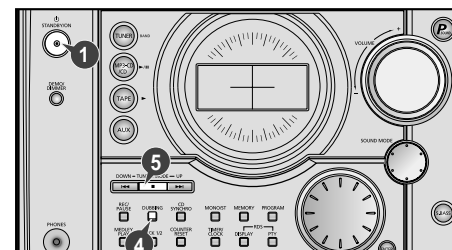

## Tape Counter

When playing a cassette in one of the cassette decks, a counter is displayed to enable you to take note of the counter value at the start of each track to start playback at the beginning of the track to which you wish to listen.

- Before starting to record a cassette for which you wish to take note of the counter values at the beginning of each track, reset the counter by pressing **COUNTER RESET**.

- Each cassette deck has a separate counter.

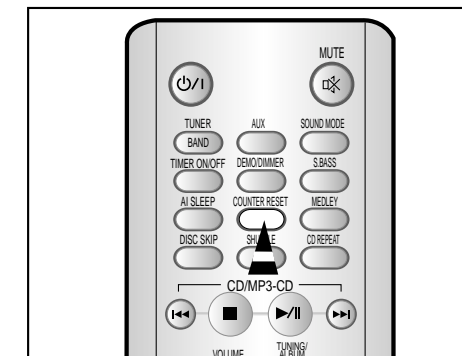
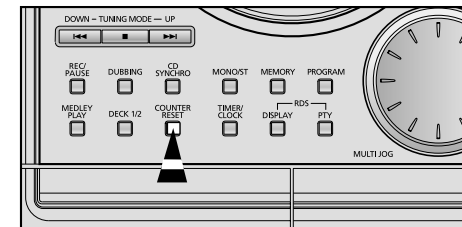

## Timer Function

The timer enables you to switch the system on or off at specific times.

**Example:** You wish to wake up to music every morning.

➤ If you no longer want the system to be switched on or off automatically, you must cancel the timer.

- ◆ Before setting the timer, check that the current time is correct.
- ◆ For each step, you have a few seconds to set the required options. If you exceed this time, you must start again.

- 1 Switch the system on by pressing **STANDBY/ON**.
- 2 Press **TIMER/CLOCK** until **TIMER** is displayed.
- 3 Press **ENTER**.  
**Result:** **ON TIME** is displayed (instead of the equalizer symbols) for a few seconds, followed by any switch-on time already set; you can set the timer switch-on time.
- 4 Set the timer switch-on time.
  - a Set the hour by tuning the **MULTI JOG** knob to the right or to the left.
  - b Press **ENTER**.  
**Result:** The minutes flash.
  - c Set the minutes by tuning the **MULTI JOG** knob to the right or to the left.
  - d Press **ENTER**.  
**Result:** **OFF TIME** is displayed (instead of the equalizer symbols) for a few seconds, followed by any switch-off time already set; you can now set the timer switch-off time.
- 5 Set the timer switch-off time.
  - a Set the hour by tuning the **MULTI JOG** knob to the right or to the left.
  - b Press **ENTER**.  
**Result:** The minutes flash.
  - c Set the minutes by tuning the **MULTI JOG** knob to the right or to the left.
  - d Press **ENTER**.  
**Result:** **VOL XX** is displayed, where **XX** corresponds to the volume already set.
- 6 Press **TUNING Down** and **Up** to adjust the volume level and press **ENTER**.  
**Result:** The source to be selected is displayed.
- 7 Turn the **MULTI JOG** knob to select the source to be played when the system switches on.
 

If you select...	You must also...
TAPE (cassette)	Insert a recorded cassette in one of the decks before setting the system to standby.
TUNER (radio)	<ol style="list-style-type: none"> <li>a Press <b>ENTER</b>.</li> <li>b Select a preset station by tuning the <b>Multi Jog</b> knob to the right or to the left.</li> </ol>
CD (compact disc)	Load one or more compact discs.
- 8 Press **ENTER** to confirm the timer.
- 9 Press **STANDBY/ON** to set the system to standby mode.  
**Result:** **T** is displayed to the top of the time, indicating that the timer has been set. The system will switch on and off automatically at the required times.

➤ If the timer switch on and off times are identical, the word **ERROR** is displayed.

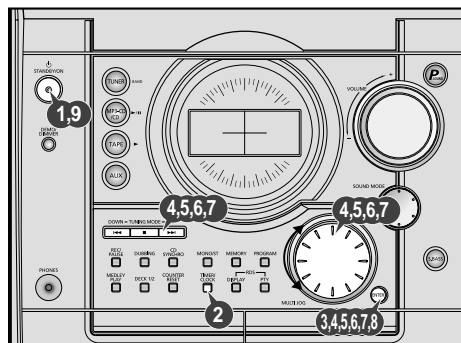

### To set the timer function

- ◆ You may use **MULTI JOG** or **◀▶** buttons to adjust in step 4, 5, 6, 7.

## Cancelling the Timer

After having set the timer, it will start automatically as shown by the **TIMER** indication on the display. If you no longer wish to use the timer, you must cancel it.

➤ You can stop the timer at any time (system on or in standby mode).

To...	Press Timer-On/Off...
Cancel the timer	Once. <b>Result:</b> <b>T</b> is no longer displayed.
Restart the timer	Twice. <b>Result:</b> <b>T</b> is displayed again.

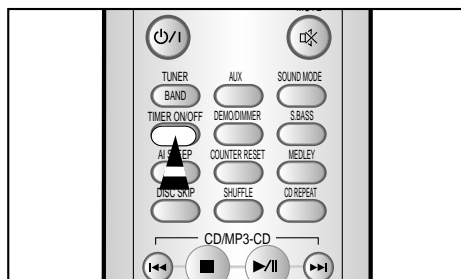

## Mute Function

You can turn the sound off temporarily on your system.

**Example:** You wish to answer a telephone call.

- 1 Press **MUTE**.
- 2 To switch the sound back on, press **MUTE** again or the **VOLUME** buttons.

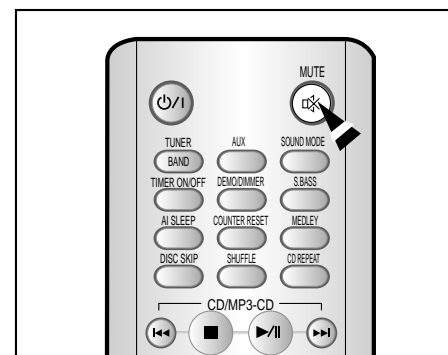

## Selecting Sound Mode

Your mini-compact system is equipped with a preset equalizer that allows you to choose the most appropriate balance between treble and bass frequencies, according to the type of music you are listening to.

Turn **SOUND MODE** on the front panel or **Press SOUND MODE** on the remote control until the required option is selected.

To obtain a...	Select...
Normal balance (linear)	PASS
Balance suitable for pop music	POP
Balance suitable for rock music	ROCK
Balance suitable for classic music	CLASSIC

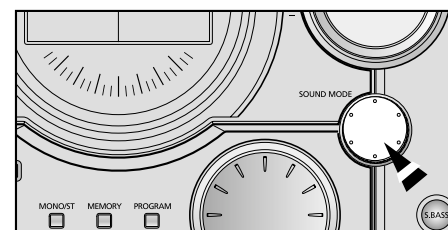

## Power Sound Function

Your mini-compact system is equipped with the function of Power Sound. The function of Power Sound amplifies bass and improves high key or bass twice as much for you to appreciate powerful real sound.

- 1 Press the **P.SOUND** button on the front panel.  
**Result:** Press **P.SOUND** button on the front panel, "**P.SOUND**" is displayed.
- 2 To cancel this function, press **P.SOUND** button again.

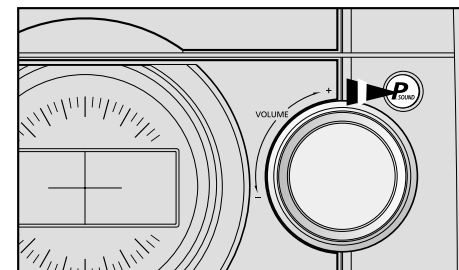

## Setting the System to Switch off Automatically

While listening to a compact disc or a cassette, you can set the system to switch off automatically.  
**Example:** You wish to go to sleep to music.

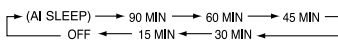
- 1 Press **AI SLEEP**.  
**Result:** playback starts and the following indications are displayed:  
**90 MIN**
- 2 Press **AI SLEEP** once or more times to indicate how long the system should continue playing before it switches off:  
  
 ➤ At any time, you can:  
 ♦ Check the remaining time by pressing **AI SLEEP**  
 ♦ Change the remaining time by repeating Steps 1 and 2
- 3 Press **AI SLEEP** once or more times until **AI SLEEP** is displayed.  
**Result:** The system will automatically switch off at the end of the disc or cassette.
- 4 To cancel SLEEP function, press **AI SLEEP** once or more times until **OFF** is display.

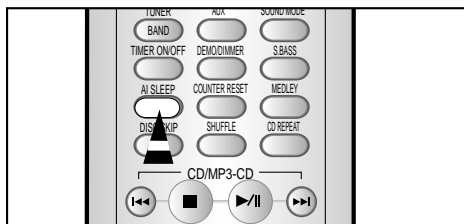

## S.BASS Level Function

Your mini-compact system has a bass amplification function called SBS (Super Bass Sound). This function makes the sound more powerful and real.

- 1 Press the **S.Bass** button on the front panel.  
**Result:** **S. BASS** is displayed and "SBS ON" is displayed for a few seconds.
- 2 To cancel this function, press **S.Bass** again, "OFF" is displayed for a few seconds.

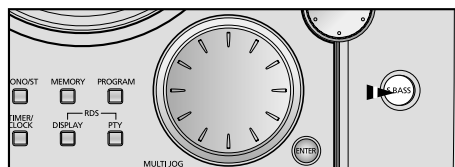

## Connecting Headphones

You can connect a set of headphones to your mini-compact system so that you can listen to music or radio programmers without disturbing other people in the room. The headphones must have a 3.5ø jack or an appropriate adapter.

Connect the headphones to the **PHONES** jack on the front panel.  
**Result:** The loudspeakers are no longer used to output the sound.

⚠ Prolonged use of headphones at a high volume may damage your hearing.

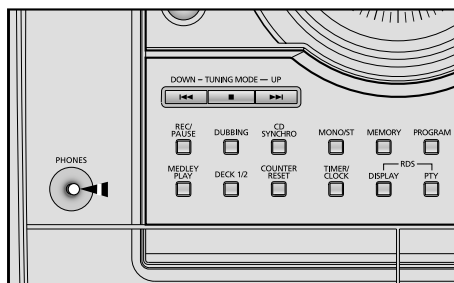

## Safety Precautions

The following diagrams illustrate the precautions to be taken when using or moving your mini-compact system.

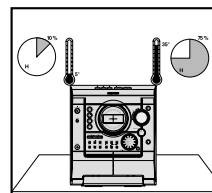

Ambient operating conditions:  
 Ambient temperature 5°C-35°C  
 Humidity 10-75%

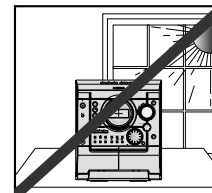

Do not expose the unit to direct sun radiation or other heat sources. This could lead to overheating and malfunction of the unit.

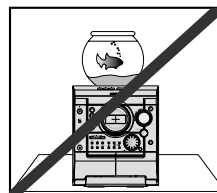

Do not place potted plants or vases on top of the unit. Moisture entering the unit could lead to dangerous electric shock and can cause equipment damage. In such events immediately disconnect the main plug from the socket.

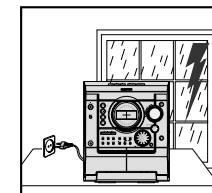

During thunderstorms, disconnect the main plug from the socket. Main voltage peaks due to lightning could damage the unit.

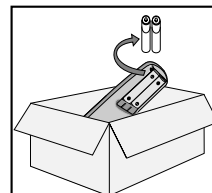

Remove the batteries from the remote control, if not used for any extended period. Leaking batteries can cause serious damage to the remote control.

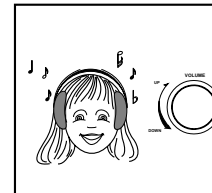

When using headphones, take care not to listen at excessive volumes. Extended use of headphones at high volumes will lead to hearing damage.

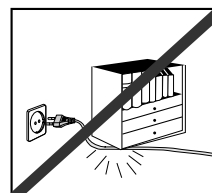

Do not place heavy items on the main lead. Main cable damage can lead to damage of the equipment (fire hazard) and can cause electric shock.

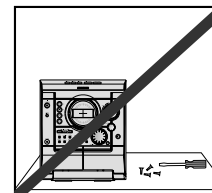

Do not remove any equipment panels. The inside of the unit contains live components, which cause electric shock.

## Cleaning Your Mini-Compact System

To obtain the best possible results from your mini-compact system, you must clean the following elements regularly:

- ♦ The outer casing
- ♦ The compact disc player
- ♦ The cassette players (heads, rollers and drive capstans)
- ⚠ Always unplug the system from the wall outlet:
  - ♦ Before cleaning it
  - ♦ If you are not going to be using it for a long time

### Outer Casing

Clean the outer casing regularly using a soft cloth and a light detergent. Do not use abrasive powders, liquids or aerosol cleaners. Never let any liquids get into the system.

### Compact Disc Player

- 1 Before playing a compact disc, clean it with a special CD cleaning agent. Do not use the same cleaning agents as for vinyl LP records. Carefully wipe the disc from the centre outward.

- 2 Regularly clean the player with a special cleaning disc (available from your local dealer).

### Tap Decks

- 1 Press **PUSH EJECT** (▲) to open the cassette deck.
- 2 Use a cotton bud and a special cassette cleaning agent to clean the:
  - ♦ Head (1)
  - ♦ Rollers (2)
  - ♦ Drive capstans (3)

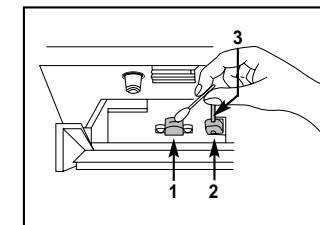

- ⚠ If you will not be using the remote control for a long time, remove the batteries to prevent corrosion.
- ♦ Although your system is very hard-wearing, it should not be used in an excessively dusty environment or subjected to shocks or extreme heat (close to heating appliances or in direct sunlight, etc.).
- ♦ If the unit emits an unpleasant odor when in use, unplug it from the main supply and contact the after-sales service.

## Precautions When Using Compact Discs

- ◆ Handle your compact discs with care. Always hold them by the edges to avoid leaving fingerprints on the shiny surface.
- ◆ When you have finished playing a compact disc, always put it back in its case.
- ◆ Do not fix paper or adhesive tape to the discs and do not write on the label.
- ◆ Clean them with a special-purpose cloth.
- ◆ Store your compact discs in a clean place, out of direct sunlight, where they will not be exposed to high temperatures.
- ◆ Always use compact discs marked .



## Precautions When Using Audio Cassettes

- ◆ Check that the tape in the cassette is sufficiently taught.
- ◆ To prevent erasing a cassette that you wish to keep, remove the safety tab on the upper edge of the cassette. To record a cassette, where the tab has been broken, simply cover the opening with adhesive tape.
- ◆ When you have finished playing a cassette, always put it back in its case.
- ◆ Store your cassettes in a clean place, out of direct sunlight, where they will not be exposed to high temperatures.
- ◆ Avoid using 120-minute cassettes as they place unnecessary strain on the tape mechanism.

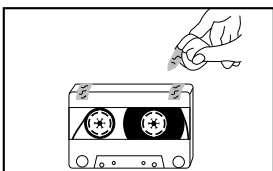
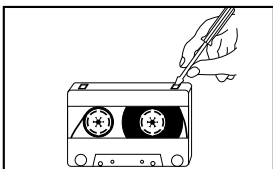
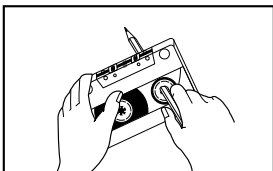

## Before Contacting the After-Sales Service

It always takes a little time to become familiar with a new appliance. If you have any of the problems listed below, try the solutions given. They may save you the time and inconvenience of an unnecessary service call.

Problem	Checks/Explanation
The system does not work	<ul style="list-style-type: none"> <li>• The main lead is not correctly plugged into a wall socket or the wall socket is not switched on.</li> <li>• The remote control batteries need replacing or the polarity has not been respected.</li> <li>• The <b>STANDBY/ON</b> button has not been pressed.</li> </ul>
There is no sound	<ul style="list-style-type: none"> <li>• The volume has been completely turned down.</li> <li>• The correct function (TUNER, CD, TAPE, AUX) has not been selected.</li> <li>• You have connected a set of earphones.</li> <li>• The loudspeaker wires have been disconnected.</li> <li>• The <b>MUTE</b> button has been pressed.</li> </ul>
The Timer does not work	<ul style="list-style-type: none"> <li>• The timer has been stopped by pressing <b>TIMER ON/OFF</b>.</li> </ul>
In case it does not work, even the action is taken as above.	<ul style="list-style-type: none"> <li>• Press the <b>P.SOUND</b> button for 5 seconds in power "OFF"(standby), then it is returned the original position (<b>RESET</b>)</li> </ul>
The compact disc player does not start playing	<ul style="list-style-type: none"> <li>• The CD function has not been selected.</li> <li>• The disc has been inserted face down or is either dirty or scratched.</li> <li>• The laser sensor is dirty or dusty.</li> <li>• The system has not been installed on a flat, horizontal surface.</li> <li>• Condensation has formed in the player; leave the system in a warm, airy room for at least one hour.</li> </ul>
The MP-3 CD player cannot be played.	<ul style="list-style-type: none"> <li>• Use the <b>PC</b> to confirm if the extension is ".mp3".</li> </ul>
The tape does not start playing	<ul style="list-style-type: none"> <li>• The <b>TAPE</b> function has not been selected.</li> <li>• The cassette has not been inserted correctly.</li> <li>• The cassette player has not been closed.</li> <li>• The tape is either slack or broken.</li> </ul>
The volume falls off	<ul style="list-style-type: none"> <li>• The audio heads are dirty.</li> </ul>
The cassette is not erased correctly	<ul style="list-style-type: none"> <li>• The rollers or drive capstans are dirty.</li> </ul>
There is excessive wow and flutter	<ul style="list-style-type: none"> <li>• The tape is worn.</li> </ul>
Reception is poor or no radio stations are received at all	<ul style="list-style-type: none"> <li>• The <b>TUNER</b> function has not been selected.</li> <li>• The radio frequency has not been correctly selected.</li> <li>• The aerial has been disconnected or is not facing the right way. Turn it until you find the best orientation.</li> <li>• You are in a building that blocks radio waves; you must use an outside aerial.</li> </ul>

If the above guidelines do not allow you to solve the problem, take a note of:

- ◆ The model and serial numbers, normally printed on the rear of the system
- ◆ Your warranty details
- ◆ A clear description of the problem

Then contact your local dealer or SAMSUNG after-sales service.

## Technical Specifications

SAMSUNG strives to improve its products at all times. Both the design specifications and these user instructions are thus subject to change without notice.

### RADIO

LW(option)	
Usable sensitivity	60 dB
AM (MW)	
Signal/noise ratio	40 dB
Usable sensitivity	54 dB
Total harmonic distortion	2 %
FM	
Signal/noise ratio	62 dB
Usable sensitivity	10 dB
Total harmonic distortion	0.3 %

### COMPACT DISC PLAYER

Capacity	3 discs
Frequency range	20 Hz - 20 KHz (± 1 dB)
Signal/noise ratio	90 dB (at 1 KHz) with filter
Distortion	0.05 % (at 1 KHz)
Channel separation	74 dB
Disc sizes	Diameter: 120 or 80 mm. Thickness: 1.2 mm

### TAPE DECK

Frequency range	125 Hz ~ 8 KHz
Signal/noise ratio	40 dB
Channel separation	35 dB
Erasing effect	50 dB

### AMPLIFIER

Output power (6 Ω)	50 Watts/CH RMS, IEC (total harmonic distortion: 10 %)
Channel separation	45 dB
Signal/noise ratio	75 dB

### GENERAL

Dimensions	270 (W) x 317 (H) x 370 (D) mm
------------	--------------------------------

THIS APPLIANCE IS MANUFACTURED BY:



AH68-01408B