

SAMSUNG

MICROWAVE OVEN

Owner's Instructions and Cooking Guide

C108ST / C108STB

C108STT / C108STF

C109ST / C109STB

C109STT / C109STF

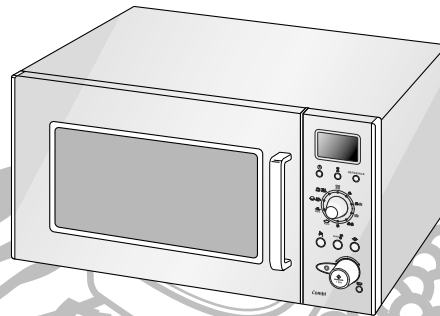

"Quick" Look-up Guide	2
Oven	3
Control Panel	3
Accessories	4
Using this Instruction Booklet	4
Safety Precautions	5
Installing Your Microwave Oven	6
Selecting the Display Language	7
Setting the Time	7
How a Microwave Oven Works	7
Checking that Your Oven is Operating Correctly	7
What to Do if You are in Doubt or You have a Problem	8
Cooking/Reheating	8
Power Levels and Time Variations	9
Stopping the Cooking	9
Adjusting the Cooking Time	9
Using the Auto Cook Feature	10
Using the Auto Reheat Feature	11
Using the Auto Defrost Feature	12
Using the Junior/Snack Cook Feature	13
Using the Cafeteria Feature	15
Cafeteria Settings	15
Using a Crusting Plate	16
Multistage Cooking	17
Setting a Standing Time	18
Choosing the Accessories	18
Preheating the Oven	18
Cooking by Convection	19
Grilling	19
Choosing the Heating Element Position	20
Spit-Roasting	20
Using The Vertical Multi-Spit	21
Combining Microwaves and the Grill	21
Combining Microwaves and Convection	22
Safety-locking Your Microwave Oven	23
Scroll Speed	23
Switching the Beeper Off	23
Manual Stop Turntable Function	23
Cookware Guide	24
Cooking Guide	25
Cleaning Your Microwave Oven	34
Storing and Repairing Your Microwave Oven	35
Installation & Wiring Instructions	35
Wiring Instructions	35
Cooking Instructions On Food Packaging	36
Cooking Instructions	36
Technical Specifications	36



“Quick” Look-up Guide

GB

I want to cook some food

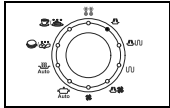

1. Turn the **Cooking Control knob** to the **Microwave** () symbol.

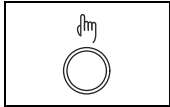

2. Press the **Select** () button until the appropriate power level is displayed.

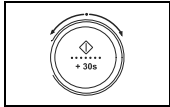

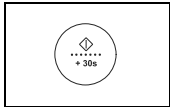

3. Select the cooking time by turning the **dial knob** as required.



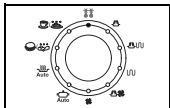

4. Press **Start** () button.
Result: Cooking starts
 - ◆ When cooking has finished, the oven will beep and flash “0” four times. The oven will then beep one time per minute.

I want to defrost some food

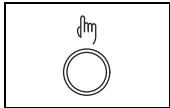

1. Place the frozen food in the oven.
Turn the **Cooking Control knob** to the **Defrost** () symbol.



2. Select the food category by pressing the **Select** () button, until the desired food category is selected.

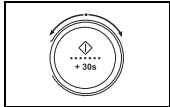

3. Select the weight by turning the **dial knob** as required.

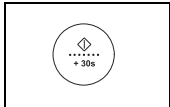

4. Press **Start** () button.
Result: Defrosting starts
 - ◆ When cooking has finished, the oven will beep and flash “0” four times. The oven will then beep once each minute thereafter.

I want to add an extra 30 seconds

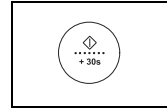

Leave the food in the oven.

Press **+30s** () button one or more times for each extra 30 seconds that you wish to add.



The first time you plug the power cord into an outlet, or after there has been an interruption in power, the display shows “SELECT YOUR LANGUAGE”. At this point, you must select a language for the display. You can choose from English, French, German, Spanish, Italian, Dutch and Russian. Please refer to page 7.

Oven

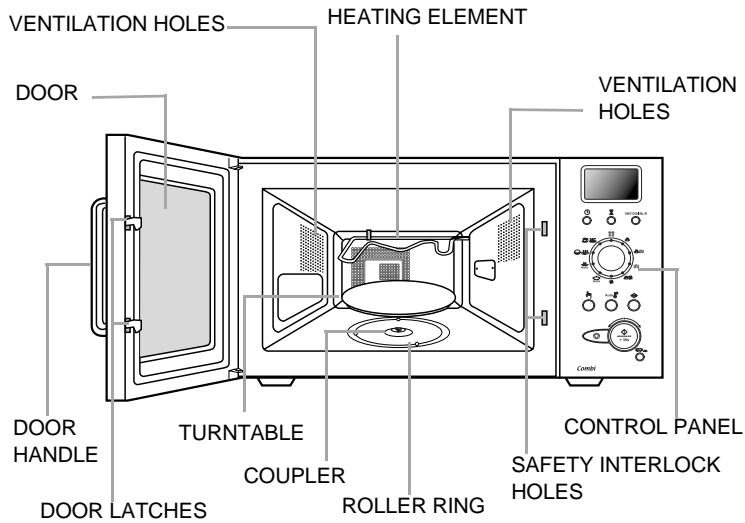

Control Panel

GB

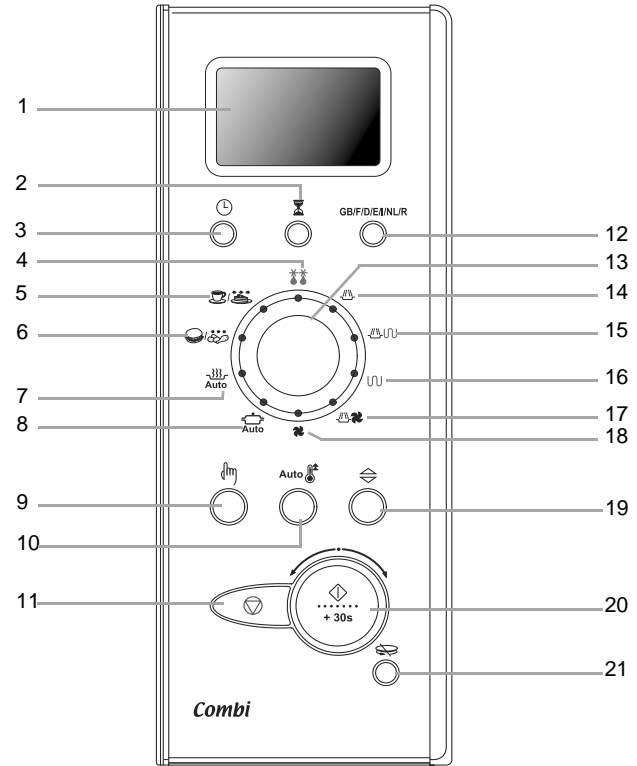

- | | |
|------------------------------------|--|
| 1. Display | 13. Cooking Control knob |
| 2. Standing time setting button | 14. Microwave mode |
| 3. Clock setting button | 15. Combined mode (microwave+grill) |
| 4. Auto defrost feature mode | 16. Grill mode |
| 5. Cafeteria mode | 17. Combined mode (microwave+convection) |
| 6. Junior/Snack mode | 18. Convection mode |
| 7. Auto reheat feature mode | 19. More/Less button |
| 8. Auto cook feature mode | 20. Start / cooking time adjustment button and time setting weight selection |
| 9. Mode selection button | 21. Turntable on / off button |
| 10. Preheat mode selection button | |
| 11. Stop / Cancel button | |
| 12. Language mode selection button | |

Accessories

Depending on the model that you have purchased, you are supplied with several accessories that can be used in a variety of ways.

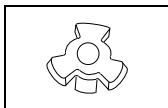

1. **Coupler**, to be placed correctly over the motor shaft in the base of the oven.

Purpose: The coupler rotates the turntable.

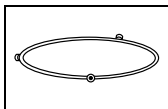

2. **Roller ring**, to be placed in the center of the oven.

Purpose: The roller ring supports the turntable.

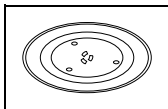

3. **Turntable**, to be placed on the roller ring with the center fitting on to the coupler.

Purpose: The turntable serves as the main cooking surface; it can be easily removed for cleaning.

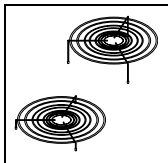

4. **Metal racks** (High rack, Low rack), to be placed on the turntable.

Purpose: The metal racks can be used to cook two dishes at the same time. A small dish may be placed on the turntable and a second dish on the rack. **The metal racks can be used in grill, convection and combination cooking.**

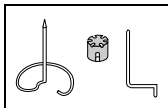

5. **Roasting spit, Coupler Barbecue and Skewer**, to be placed in the glass bowl (C108STB/C108STF/C109STB/C109STF only).

Purpose: The roasting spit is a convenient way of barbecuing a chicken, as the meat does not have to be turned over. It can be used for grill combination cooking.

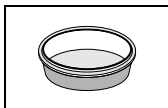

6. **Glass bowl**, to be placed on the turntable (C108STB/C108STF/C109STB/ C109STF only).

Purpose: Roasting stand is placed on the glass bowl.

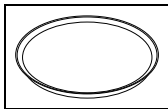

7. **Crusting plate**, to be placed on the turntable (C108STT/ C108STF/C109STT/ C109STF only).

Purpose: The crusting plate is used to brown food better in the microwave or grill combination cooking modes and to keep pastry and pizza dough crisp.

Using this Instruction Booklet

Thank you for purchasing a SAMSUNG microwave oven. Your Owner's Instructions contains much valuable information on cooking with your new microwave oven:

- Safety precautions
- Accessories and cookware
- Useful cooking tips

Inside the cover you will find a quick look-up guide explaining three basic cooking operations:

- Cooking (microwave mode)
- Defrosting
- Adding an extra 30 seconds, if the dish is inadequately cooked or requires additional reheating

At the end of the booklet you will find illustrations of the oven, and more importantly the control panel, so that you can find the buttons more easily.

The illustrations in the step-by-step procedures use two different symbols.



Important



Note

PRECAUTIONS TO AVOID POSSIBLE EXPOSURE TO EXCESSIVE MICROWAVE ENERGY

Failure to observe the following safety precautions may result in harmful exposure to microwave energy.

- Under no circumstances should any attempt be made to operate the oven with the door open or to tamper with the safety interlocks (door latches) or to insert anything into the safety interlock holes.
- Do not place any object between the oven door and front face, or allow food or cleaner residues to accumulate on sealing surfaces. Ensure that the door and door sealing surfaces are kept clean by wiping after use with first a damp cloth and then a final wipe with a soft dry cloth.
- Do not operate the oven if it is damaged until it has been repaired by a qualified microwave service technician trained by the manufacturer. It is particularly important that the oven door closes properly and that there is no damage to the:
 - (1) Door, door seals and sealing surfaces
 - (2) Door hinges (broken or loose)
 - (3) Power cable
- The oven should not be adjusted or repaired by anyone other than a properly qualified microwave service technician trained by the manufacturer.

Safety Precautions

Important Safety Instructions.

Read Carefully and keep for future reference.

Before cooking food or liquids in your microwave oven, please check that the following safety precautions are taken.

- DO NOT** use any metallic cookware in the microwave oven:
 - Metallic containers
 - Dinnerware with gold or silver trimmings
 - Skewers, forks, etc.

Reason: Electric arcing or sparking may occur and may damage the oven.
- DO NOT** heat:
 - Airtight or vacuum-sealed bottles, jars, containers. Ex) Baby food jars
 - Airtight food. Ex) Eggs, nuts in shells, tomatoes

Reason: The increase in pressure may cause them to explode.
Tip: Remove lids and pierce skins, bags, etc.
- DO NOT** operate the microwave oven when it is empty.

Reason: The oven walls may be damaged.
Tip: Leave a glass of water inside the oven at all times. The water will absorb the microwaves if you accidentally set the oven going when it is empty.
- DO NOT** cover the rear ventilation slots with cloths or paper.

Reason: The cloths or paper may catch fire as hot air is evacuated from the oven.
- ALWAYS** use oven gloves when removing a dish from the oven.

Reason: Some dishes absorb microwaves and heat is always transferred from the food to the dish. The dishes are therefore hot.
- DO NOT** touch heating elements or interior oven walls.

Reason: These walls may be hot enough to burn skin even after cooking is finished, even though they do not appear to be so. Keep away from hot spot. Do not allow inflammable materials to come into contact with any interior area of the oven. Let the oven cool down first.
- To reduce the risk of fire in the oven cavity
 - Do not store flammable materials in the oven
 - Remove wire twist ties from paper or plastic bags
 - Do not use your microwave oven to dry newspapers
 - If smoke is observed, keep the oven door closed and switch off or disconnect the oven from the power supply.
- Take particular care when heating liquids and baby foods.

- ALWAYS allow a standing time of at least 20 seconds after the oven has been switched off to allow the temperature to equalize.
 - Stir during heating if necessary and ALWAYS stir after heating.
 - To prevent eruptive boiling and possible scalding, you should stir before, during, and after heating.
 - In the event of scalding, follow these FIRST AID instructions :
 - * Immerse hand in cold water for at least 10 minutes.
 - * Cover with clean, dry dressing.
 - * Do not apply any creams, oils or lotions.
 - **NEVER** fill the container to the top and choose a container that is wider at the top than at the bottom to prevent the liquid from boiling over. Bottles with narrow necks may also explode if overheated.
 - **ALWAYS** check the temperature of baby food or milk before giving it to the baby.
 - **NEVER** heat a baby's bottle with the teat on, as the bottle may explode if overheated.
 - During microwave heating of beverages, there are results in delayed eruptive boiling, therefore care has to be taken when handling the container.
- Be careful not to damage the power cable.
 - Do not immerse power cable or plug in water and keep power cable away from heated surfaces.
 - Do not operate this appliance if it has a damaged power cable or plug.
 - Stand at arm's length from the oven when opening the door.

Reason: The hot air or steam released may cause scalding.
 - Keep the inside of the oven clean.
 - Clean the inside of the oven right after each use with a mild detergent solution, but let the microwave oven cool down before cleaning in order to avoid injury.

Reason: Food particles or spattered oils stuck to oven walls or floor can cause the damage of painting and reduce the efficiency of the oven.
 - "Clicking" sound might be noticed while operating, especially in defrosting mode.

Reason: When the power output is changing electrically, you may hear that sound. This is normal.

Safety Precautions (continued)

GB

13. If the microwave oven is operating without any load, the power will cut off automatically for safety. After standing for over 30 min, you can operate the oven normally.
- Do not worry is the oven continues to work after cooking has finished.
- Reason:** This product is designed to fan for some minutes, not operating microwave oven(MWO), to cool down the inner electronic parts when the stop button is pressed or the door is opened after finishing cooking in case that the oven operates for some minutes in cooking(MWO, GRILL, CONVECTION, MWO+GRILL, MWO+CONVECTION). When cooking has finished, the oven will beep and flash "0" four times. The oven will then beep one time per minute.

IMPORTANT SAFETY INSTRUCTIONS

During cooking, you should look into the oven from time to time when food is being heated or cooked in disposable containers of plastic paper or other combustible material.

WARNING:

Do not use the door or door seals are damaged, the oven must not be operated until it has been repaired by a competent person.

WARNING:

It is hazardous for anyone other than a competent person to carry out any service or repair operation which involves the removal of a cover which gives protection against exposure to microwave energy.

WARNING:

Liquids and other foods must not be heated in sealed containers since they are liable to explode.

WARNING:

Only allow children to use the oven without supervision when adequate instructions have been given so that the child is able to use the oven in a safe way and understands the hazards of improper use.

WARNING:

Oven casing and door will get hot during convection and combination cooking.

- DO NOT operate the microwave oven without the coupler, roller ring and turntable.

Installing Your Microwave Oven

This microwave oven can be placed almost anywhere (kitchen work surface or shelf, movable trolley, table).

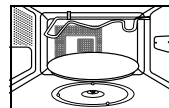
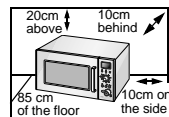

- When you install your oven, make sure there is adequate ventilation for your oven by leaving at least 10 cm (4 inches) of space behind, and on the sides of the oven and 20 cm (8 inches) of space above the oven and 85 cm (33 inches) of the floor.
- Remove all packing materials inside the oven. Install the roller ring and turntable. Check that the turntable rotates freely.
- This microwave oven has to be positioned so that plug is accessible.



Never block the air vents as the oven may overheat and automatically switch itself off. It will remain inoperable until it has cooled sufficiently.



For your personal safety, plug the cable into a 3-pin, 230 Volt, 50Hz, AC earthed socket. If the power cable of this appliance is damaged, it must be replaced by a special cable PENCON(UD13A1). Contact your local dealer to have it replaced.



Do not install the microwave oven in hot or damp surroundings like next to a traditional oven or radiator. The power supply specifications of the oven must be respected and any extension cable used must be of the same standard as the power cable supplied with the oven. Wipe the interior and the door seal with a damp cloth before using your microwave oven for the first time.

Selecting the Display Language

The first time you plug the power cord into an outlet, or after there has been an interruption in power, the display shows “SELECT YOUR LANGUAGE”. At this point, you can select a language for the display. You can choose from English, French, German, Spanish, Italian, Dutch and Russian.



1. Press the **Language** button immediately after plugging in your microwave, or immediately after a power shortage.
Result: If you continue to press the **Language** button, the settings will cycle in the following order: ENGLISH(LBS), ENGLISH(KG), FRENCH, GERMAN, SPANISH, ITALIAN, DUTCH, RUSSIAN.

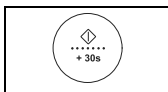

2. When you have selected the language and display you want to use, press the **Start** () button to end this procedure.

Setting the Time

Your microwave oven has an inbuilt clock. The time can be displayed in either the 24-hour or 12-hour notation. You must set the clock:

- When you first install your microwave oven
- After a power failure

 Do not forget to reset the clock when you switch to and from summer or winter time.

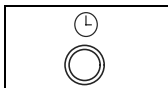

1. To display the time in the...
12-hour notation Then press the **Clock** () button...
24-hour notation Once
 Twice
2. Turn the **dial knob** to set the hour.



3. Press the **Clock** () button.

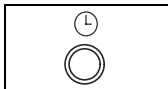

4. Turn the **dial knob** to set the minute.



5. When the right time is displayed, press the **Clock** () button to start the clock.
Result: The time is displayed whenever you are not using the microwave oven.

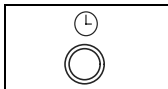

How a Microwave Oven Works

Microwaves are high-frequency electromagnetic waves; the energy released enables food to be cooked or reheated without changing either the form or the colour.

You can use your microwave oven to:

- Defrost
- Reheat
- Cook

Cooking Principle

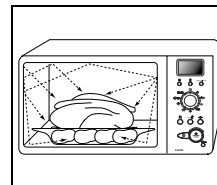

1. The microwaves generated by the magnetron are distributed uniformly as the food rotates on the turntable. The food is thus cooked evenly.
2. The microwaves are absorbed by the food up to a depth of about 1 inch (2.5 cm). Cooking then continues as the heat is dissipated within the food.
3. Cooking times vary according to the container used and the properties of the food:
 - Quantity and density
 - Water content
 - Initial temperature (refrigerated or not)

-  As the centre of the food is cooked by heat dissipation, cooking continues even when you have taken the food out of the oven. Standing times specified in recipes and in this booklet must therefore be respected to ensure:
- Even cooking of the food right to the centre
 - The same temperature throughout the food



Checking that Your Oven is Operating Correctly

The following simple procedure enables you to check that your oven is working correctly at all times. If you are in doubt, refer to the section entitled “What to Do if You are in Doubt or Have a Problem” on the page.

-  The oven must be plugged into an appropriate wall socket. The turntable must be in position in the oven. If a power level other than the maximum (100% - 900 W) is used, the water takes longer to boil.

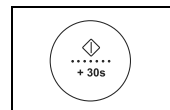
Open the oven door by pulling the handle on the right side of the door. Place a glass of water on the turntable. Close the door.





1. Press the **Start** () button and set the time to 4 or 5 minutes, by pressing the **Start** () button the appropriate number of times.
Result: The oven heats the water for 4 or 5 minutes. The water should then be boiling.

What to Do if You are in Doubt or You have a Problem

GB

Becoming familiar with a new appliance always takes a little time. If you have any of the problems listed below, try the solutions given. They may save you the time and inconvenience of an unnecessary service call.

- ◆ The following are normal occurrences.
 - Condensation inside the oven
 - Air flow around the door and outer casing
 - Light reflection around the door and outer casing
 - Steam escaping from around the door or vents
- ◆ The food is not cooked at all
 - Have you set the timer correctly and pressed the **Start** () button?
 - Is the door closed?
 - Have you overloaded the electric circuit and caused a fuse to blow or a breaker to be triggered?
- ◆ The food is either overcooked or undercooked
 - Was the appropriate cooking length set for the type of food?
 - Was an appropriate power level chosen?
- ◆ Sparking and cracking occur inside the oven (arcing)
 - Have you used a dish with metal trimmings?
 - Have you left a fork or other metal utensil inside the oven?
 - Is aluminium foil too close to the inside walls?
- ◆ The oven causes interference with radios or televisions
 - Slight interference may be observed on televisions or radios when the oven is operating. This is normal.
 - * Solution: Install the oven away from televisions, radios and aerials.
 - If interference is detected by the oven's microprocessor, the display may be reset.
 - * Solution: Disconnect the power plug and reconnect it. Reset the time.
- ◆ "3" message indicates
 - The "E3" message is automatically activated prior to the microwave oven overheating. Should the "E3" message be activated, then depress the "" key to utilize the initialization mode.

If the above guidelines do not enable you to solve the problem, then contact your local Samsung customer service centre.

Please have the following information read;

- The model and serial numbers, normally printed on the rear of the oven
- Your warranty details
- A clear description of the problem

Then contact your local dealer or SAMSUNG aftersales service.

Cooking/Reheating

The following procedure explains how to cook or reheat food.

- ☞ ALWAYS check your cooking settings before leaving the oven unattended.

Open the door. Place the food in the centre of the turntable. Close the door. Never switch the microwave oven on when it is empty.

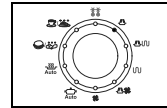

1. Turn the **Cooking Control knob** to the **Microwave** () symbol.

Result: The following indications are displayed:
| (one-stage cooking)
 (microwave mode)

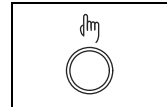



2. Select the appropriate power level by pressing the **Select** () button again until the corresponding output power is displayed. Refer to the power level table below for further details.

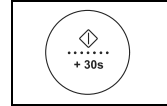

3. Set the cooking time by turning the **dial knob**.
 - Example: For a cooking time of 3 minutes, 30 seconds, turn the dial knob to the right to set 3:30.Result: The cooking time is displayed.



4. Press the **Start** () button.Result: The oven light comes on and the turntable starts rotating. Cooking starts and when it has finished:
 - ◆ When cooking has finished, the oven will beep and flash "0" four times. The oven will then beep one time per minute.

☒ If you would like to know the current Power Level of the oven cavity, press **Select** () button once. If you would like to change the power level during cooking, press the **Select** () button twice or more times to select the desired power level.

☒ If you wish to heat a dish for a short period of time at maximum power (900W), you can also simply press the **Start** () button once for each 30 seconds of cooking time. The oven starts immediately.

Power Levels and Time Variations

The power level function enables you to adapt the amount of energy dissipated and thus the time required to cook or reheat your food, according to its type and quantity. You can choose between six power levels.

Power Level	Percentage	Output
HIGH	100%	900W
MEDIUM HIGH	67%	600W
MEDIUM	50%	450W
MEDIUM LOW	33%	300W
DEFROST	20%	180W
LOW	11%	100W

The cooking times given in recipes and in this booklet correspond to the specific power level indicated.

If you select a...	Then the cooking time must be...
Higher power level	Decreased
Lower power level	Increased

Stopping the Cooking

You can stop cooking at any time so that you can:

- Check the food
- Turn the food over or stir it
- Leave it to stand

To stop the cooking...	Then...
Temporarily	Open the door. Result: Cooking stops. To resume cooking, close the door again and press the Start (◊) button.
Completely	Press the Stop (⊖) button. Result: Cooking stops. If you wish to cancel the cooking settings, press the Stop (⊖) button again.

Adjusting the Cooking Time

Like traditional cooking, you may find that, depending on the food's characteristics or your tastes, you have to adjust the cooking times

- *slightly. You can:*
 - Check how cooking is progressing at any time simply by opening the door
 - Increase or decrease the remaining cooking time

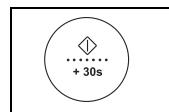

1. To increase the cooking time of your food, press the **Start**(◊) button once for each 30 seconds that you wish to add.

- Example: To add three minutes, press the **Start**(◊) button six times.

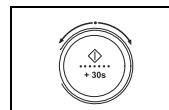

2. During the cooking, to increase or decrease the cooking time of your food, turn the **dial knob** right or left.

Using the Auto Cook Feature

GB

The Auto Cook () feature has four pre-programmed cooking times. You do not need to set either the cooking times or the power level.

You can adjust the size of the serving by turning the dial knob.

 Use only recipients that are microwave-safe.

Open the door. Place the food in the centre of the turntable. Close the door.

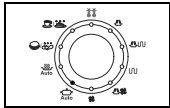

1. Turn the **Cooking Control knob** to the **Auto Cook** () symbol.

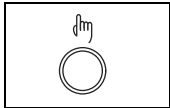

2. Select the type of food that you are cooking by pressing the **Select** () button. Refer to the table on the following page for a description of the various pre-programmed settings.

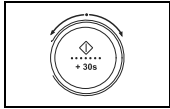

3. Select the size of the serving by turning the **dial knob**.

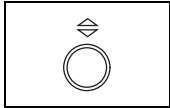

4. Increase or decrease the cooking time, if necessary, by pressing the **More/Less** () buttons respectively.

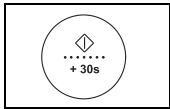

5. Press the **Start** () button.
Result: The food is cooked according to the pre-programmed setting selected.
 - ◆ When cooking has finished, the oven will beep and flash "0" four times. The oven will then beep one time per minute.

The following table presents the various Auto Cook Programmes, quantities, standing times and appropriate recommendations.

Programmes no 1 and 2 are running with microwave energy only.

Programmes no 3 and 4 are running with a combination of microwaves and grill.

Programme no 5 is running with a combination of microwaves and convection.

Code	Food	Serving Size	Standing Time	Recommendations
1	Fresh Vegetables	200-250 g 300-350 g 400-450 g 500-550 g 600-650 g 700-750 g	3 min.	Weigh the vegetables after washing, cleaning and cutting into similar size. Put them into a glass bowl with lid. Add 30 ml (2 tablespoons) water when cooking for 200-250 g, add 45 ml (3 tablespoons) for 300-450 g and add 60-75 ml (4-5 tablespoons) for 500-750 g. Stir after cooking. When cooking higher quantities stir once during cooking.
2	Peeled Potatoes	300-350 g 400-450 g 500-550 g 600-650 g 700-750 g	3 min.	Weigh the potatoes after peeling, washing and cutting into a similar size. Put them into a glass bowl with lid. Add 45 ml (3 tablespoons) water when cooking 300-450g, add 60ml (4 tablespoons) for cooking 500-750 g.
3	Roast Fish	200-300 g (1 fish) 400-500 g (1-2) 600-700 g (2) 800-900 g (2-3)	3 min.	Brush skin of whole fish with oil and add herbs and spices. Put fish side by side, head to tail on the high metal rack. Turn over, as soon as the beep sounds.

Using the Auto Cook Feature (continued)

4	Chicken Pieces	200-300 g (1pc)	3min.	Brush the chicken pieces with oil and spice them with pepper, salt and paprika. Put them in a circle on the high rack with the skin-side down. Turn over, as soon as the beep sounds.
		400-500 g (2pcs) 600-700 g (3pcs) 800-900 g (3-4pcs)		
5	Roast Beef/	900-1000 g	10-15 min.	Brush the beef/lamb with oil and spices (pepper only, salt should be added after roasting). Put it on the low rack with the fat-side down. Turn over, when the oven beeps. After roasting and during standing time it should be wrapped in aluminium foil.
	Roast Lamb	1200-1300 g		
		1400-1500 g		

Using the Auto Reheat Feature

The Auto Reheat () feature has four pre-programmed cooking times. You do not need to set either the cooking times or the power level.

You can adjust the size of the serving by turning the dial knob.

 Use only recipients that are microwave-safe.

Open the door. Place the food in the centre of the turntable. Close the door.

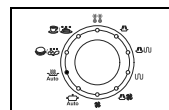

1. Turn the **Cooking Control knob** to the **Auto Reheat** () symbol.

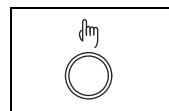

2. Select the type of food that you are cooking by pressing the **Select** () button. Refer to the table on the following page for a description of the various pre-programmed settings.

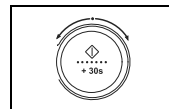

3. Select the size of the serving by turning the **dial knob**.

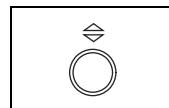

4. Increase or decrease the cooking time, if necessary, by pressing the **More/Less** () buttons respectively.

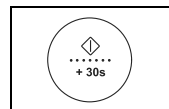

5. Press the **Start** () button.
Result: The food is cooked according to the pre-programmed setting selected.
 - ◆ When cooking has finished, the oven will beep and flash "0" four times. The oven will then beep one time per minute.

Using the Auto Reheat Feature (continued)

The following table presents the various Auto Reheat & Cook Programmes, quantities, standing times and appropriate recommendations. Programmes no 1 and 2 are running with microwave energy only.

Programmes no 3 and 4 are running with a combination of microwaves and convection.

Code	Food	Serving Size	Standing Time	Recommendations
1	Ready Meal (chilled)	300 - 350 g 400 - 450 g 500 - 550 g	3min.	Put on a ceramic plate and cover with microwave cling film. This programme is suitable for meals consisting of 3 components (e.g. meat with sauce, vegetables and a side dish like potatoes, rice or pasta).
2	Soup/sauce (chilled)	200 - 250 ml 300 - 350 ml 400 - 450 ml 500 - 550 ml 600 - 650 ml 700 - 750 ml	2 - 3min.	Pour into a deep ceramic soup plate or bowl and cover with plastic lid during heating. Stir the soup, as soon as the oven beeps (oven keeps operating and is stopped, when you open the door). Stir carefully before and after standing time
3	Frozen Pizza	300-400 g 450-550 g 600-700 g	-	Place one frozen pizza (-18°C) on the low rack, place two frozen pizzas on the low and high rack
4	Frozen Bread Rolls	100-150 g (2pcs) 200-250 g (4pcs) 300-350 g (6pcs) 400-450 g (8pcs)	3 - 5min.	Put 2 to 6 frozen bread rolls (-18°C) in a circle on the low rack. Put 8 frozen bread rolls equally on the low and high rack. This program is suitable for small frozen bakery products as bread rolls, ciabatta rolls and small baguettes.

Using the Auto Defrost Feature

The Auto Defrost (🍖) feature enables you to defrost steaks/ chops/ minced meat/ chicken pieces, meat joint, chicken, fish, bread and cake. The defrost time and power level are set automatically. You simply select the programme and the weight.

☞ Use only containers that are microwave-safe.

Open the door. Place the frozen food in the center of the turntable. Close the door.

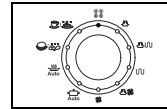

1. Turn the **Cooking Control knob** to the **Auto Defrost (🍖)** symbol.

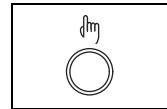

2. Select the type of food that you are cooking by pressing the **Select (👆)** button. Refer to the table on the following page for a description of the various pre-programmed settings.

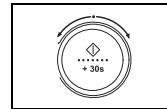

3. Select the food weight by turning the **dial knob**.

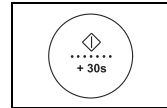

4. Press **Start (◇)** button.

Result:

- ◆ Defrosting begins.
- ◆ The oven beeps half way through defrosting to remind you to turn the food over.

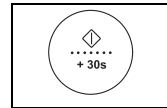

5. Press the **Start (◇)** again to finish defrosting.
Result: When cooking has finished, the oven will beep and flash "0" four times. The oven will then beep one time per minute.

☞ You can also defrost food manually. To do so, select the microwave cooking/reheating function with a power level of 180 W. Refer to the section entitled "Cooking/Reheating" on page 8 for further details.

Using the Auto Defrost Feature (continued)

The following table presents the various Auto Defrost programmes, quantities, standing times and appropriate recommendations. Remove all kind of package material before defrosting. Place meat, poultry and fish on a ceramic plate.

Code	Food	Serving Size	Standing Time	Recommendations
1	Meat	200-2000g	20-60 min.	Shield the edges with aluminium foil. Turn the meat over, when the oven beeps. This programme is suitable for beef, lamb, pork, steaks, chops and minced meat.
2	Poultry	200-2000g	20-60 min.	Shield the leg and wing tips with aluminium foil. Turn the poultry over, when the oven beeps. This programme is suitable for whole chicken as well as for chicken pieces.
3	Fish	200-2000g	20-50 min.	Shield the tail of a whole fish with aluminium foil. Turn the fish over, when the oven beeps. This programme is suitable for whole fishes as well as for fish fillets.
4	Bread/ Cake	125-1000g	5-30 min.	Put bread or cake on a piece of kitchen paper and turn over, as soon as the oven beeps (oven keeps operating and is stopped, when you open the door). This programme is suitable for all kinds of bread, sliced or whole, as well as for bread rolls and baguettes. Arrange bread rolls in a circle. This programme is suitable for all kinds of yeast cake, biscuit, cheese cake and puff pastry. It is not suitable for short/crust pastry, fruit and cream cakes as well as for cake with chocolate topping.
5	Fruit	100-600g	5-10 min.	Spread fruits evenly into a flat glass dish or use a flat ceramic plate. This programme is suitable for all kinds of fruit.

Using the Junior/Snack Cook Feature

The Junior/Snack (🍷) Cook feature has six pre-programmed cooking time, you do not need to set either the cooking time or power level. You can adjust the number of servings by turning the dial knob. First, place the food in the centre of the turntable and close the door.

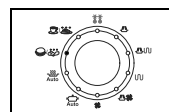

1. Turn the **Cooking Control knob** to the **Junior/Snack** (🍷) symbol.

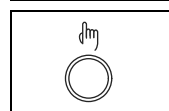

2. Select the type of food that you are cooking by pressing the **Select** (🍷) button. Refer to the table on the following page for a description of the various pre-programmed settings.

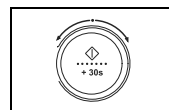

3. Select the size of the serving by turning the **dial knob**.

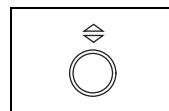

4. Increase or decrease the cooking time, if necessary, by pressing the **More/Less** (◊) buttons respectively.

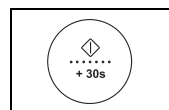

5. Press **Start** (◊) button.

Result: The food is cooked according to the pre-programmed setting selected.

- ◆ When cooking has finished, the oven will beep and flash "0" four times. The oven will then beep one time per minute.

Using the Junior/Snack Cook Feature (continued)

GB

The following table presents Auto Programmes for types of food and snacks which are favoured by children and for trendy finger food. It contains its quantities, standing times and appropriate recommendations.

Programmes no 1, 2, 5 and 6 are running with microwave energy only. Programme no 3 is running with a combination of microwaves and grill. Programme no 4 is running with a combination of microwaves and convection.

Code	Food	Serving Size	Standing Time	Recommendations
1	Hamburger (chilled)	150 g (1pc) 300 g (2pcs)	1-2 min	Put hamburger (bread roll with slice of beef) or cheeseburger on kitchen paper. Put one hamburger in the centre of turntable, put two hamburgers opposite to each other on turntable. After reheating garnish with lettuce, tomato slice, dressing and spices.
2	Mini Ravioli (chilled)	200-250 g 300-350 g	3 min	Put chilled ready mini ravioli in a microwave proof plastic dish in the centre of turntable. Pierce film of ready product or cover plastic dish with microwave wrap. Stir carefully before and after standing time. This programme is suitable for ravioli, as well as for noodles in sauce.
3	Frozen Chicken Wings	200-250 g 300-350 g 400-450 g	2 min	Put the frozen ready chicken wings or small drumsticks (pre-cooked and spiced) on the metal rack with the skin-side down. Put them in a circle and leave the centre clear. Turn over when the oven beeps.
4	Frozen Pizza Snacks	150 g (4-6pcs) 250 g (7-9pcs)	-	Put the frozen pizza snacks or mini quiches evenly on high metal rack.

5	Popcorn	100 g	-	Use special popcorn product for preparing in microwave oven. Follow the instructions of food manufacturer and put the bag in the centre of turntable. During this programme corn will pop and the bag will increase in volume. Be careful when taking out and opening the hot bag.
6	Nachos	125 g	-	Put nachos (tortilla chips) on a flat ceramic plate. Put 50g grated cheddar cheese and spices on top. Place on turntable.

Using the Cafeteria Feature

With the Cafeteria (☕) feature, the cooking time is set automatically. You can adjust the number of servings by turning the dial knob.

First, place the food in the centre of the turntable and close the door.

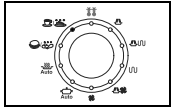

1. Turn the **Cooking Control knob** to the **Cafeteria (☕)** symbol.



2. Select the type of food that you are cooking by pressing the **Select (⏸)** button. Refer to the table on the following page for a description of the various pre-programmed settings.

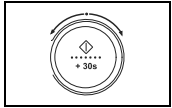

3. Select the size of the serving by turning the **dial knob**.

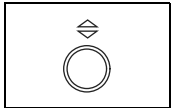

4. Increase or decrease the cooking time, if necessary, by pressing the **More/Less (⬅➡)** buttons respectively.

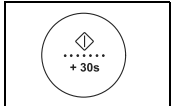

5. Press **Start (▶)** button.

Result: The food is cooked according to the pre-programmed setting selected.

- ◆ When cooking has finished, the oven will beep and flash "0" four times. The oven will then beep one time per minute.

Cafeteria Settings

The following table presents Auto Programmes for Reheat of drinks and defrosting and warming frozen cake.

It contains its quantities, standing times and appropriate recommendations.

Programme no 1 is running with microwave energy only. Programme no 2 is running with a combination of microwaves and convection.

Button	Food	Serving Size	Standing Time	Recommendations
1 ☕	Drinks Coffee, milk, tea, water (room- temperature)	150 ml (1 cup) 300 ml (2 cups) 450 ml (3 cups) 600 ml (4 cups)	1-2 mins	Pour the liquid into ceramic cups only and reheat uncovered. Place one cup in the centre, 2 cups opposite to each other and 3 or 4 cups in a circle. Leave them to stand in the microwave oven. Stir drinks before and after standing time. Be careful while taking the cups out (see safety instructions for liquids).
2 🍰	Frozen Cake	200-300 g 400-500 g 600-700 g 800-900 g 1000-1100 g 1200-1300 g	5-20 mins	Put frozen cake in the middle, put frozen cake pieces in a circle on low rack. Set rack in the middle of oven on turntable. By the help of convection the cake will be warmed and crisp up. This programme is suitable for cake (round) and cake pieces, such as fruit cake with crumble topping, streusel cake or cake with poppy seeds. It is not suitable for cake with cream filling and cake with chocolate topping.

Using a Crusting Plate

GB



C108STT / C108STF / C109STT / C109STF only

Normally when cooking food in just a microwave oven, or through the microwave mode in grill/convection ovens, foods that are made with pastries normally become soggy. Using the Samsung Crusting plate helps maintain the crispiness of your food

The crusting plate can also be used for bacon, eggs, sausages, etc.

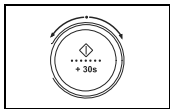
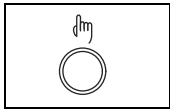
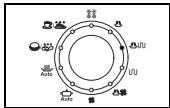
- ➔ Before using the crusting plate, preheat it by selecting the combination mode for 3 to 5 minutes:
- Combination of convection (250°C) and microwaves (600 W power level) **or**
 - Combination of grill and microwaves (600 W power level)
 - See page 21 and page 22 respectively.
1. Preheat the crusting plate, as described above.
 - Use oven gloves at all times as the crusting plate will become very hot.
 2. Brush the plate with oil if you are cooking food, such as bacon and eggs, in order to brown the food nicely.
 3. Place the food on the crusting plate.
 - Do not place any recipients on the crusting plate that are not heat-resistant (plastic bowls for example).
 4. Place the crusting plate on the turntable in the microwave oven.
 - Never place the crusting plate in the oven without the turntable.



5. Turn the **Cooking Control knob** to the **Combi** () symbol.
6. Select the appropriate power level by pressing the **Select** () button.
7. Then set the cooking time by turning the **dial knob** until the appropriate cooking time is displayed.

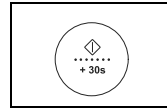

8. Press the **Start** () button.

Result: Cooking starts.

- ◆ When cooking has finished, the oven will beep and flash "0" four times. The oven will then beep one time per minute.

How to clean the crusting plate

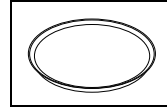

The best way to clean the crusting plate is to wash it with hot water and detergent and then rinse it off with clean water. Do not use a scrubbing brush or a hard sponge otherwise the top layer will be damaged.



As the crusting plate has a Teflon layer, if you use it incorrectly, it can be damaged.

- Never cut the food on the plate. Remove the food from the plate prior to cutting.
- Turn the food over preferably with a plastic or wooden spatula.

Multistage Cooking

Your microwave oven can be programmed to cook food in up to four stages (the Convection, Microwave+Convection and Preheat mode can not be used in Multistage cooking). Example: You wish to defrost food and cook it without having to reset the oven after each stage. You can thus defrost and cook a 1.8 kg chicken in four stages:

- Defrosting
- Standing for 20 minutes
- Microwave cooking for 30 minutes
- Grill for 15 minutes

➔ Defrosting and standing must be the first two stages. Combination and Grill can only be used once during the remaining two stages. However microwave can be used twice (at two different power levels).

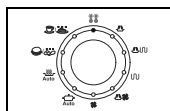

1. Turn the **Cooking Control knob** to the **Auto Defrost** () symbol.

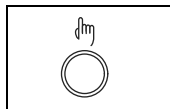

2. Select the type of food that you are cooking by pressing the **Select** () button.

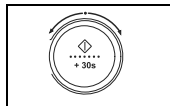

3. Set the weight by turning the **dial knob** the appropriate number of times (1800 g in the example).

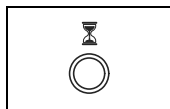

4. Press the **Hold/Delay** () button.

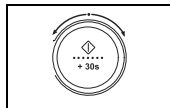

5. Set the standing time by turning the **dial knob** the appropriate number of times (20 minutes in the example).

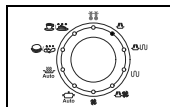

6. Turn the **Cooking Control knob** to the **Microwave** () symbol.

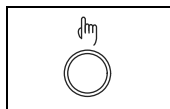

7. Set the microwave power level by pressing the **Select** () button to select the appropriate Power Level (450W in the example)

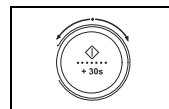

8. Set the cooking time by turning the **dial knob** (30 minutes in the example).

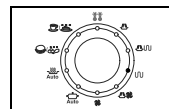

9. Turn the **Cooking Control knob** to the **Grill** () symbol.

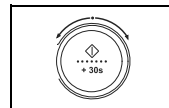

10. Set the cooking time by turning the **dial knob** the appropriate number of times (15 minutes in the example).

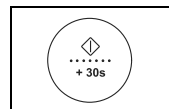

11. Press **Start** () button.

Result: Cooking starts:

- ◆ When cooking has finished, the oven will beep and flash "0" four times. The oven will then beep one time per minute.

Setting a Standing Time

The **Hold Time** can be used to set a standing time automatically (without microwave cooking).

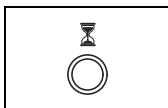

1. Press the **Hold/Delay** () button.
Result: The following indication is displayed :
 (Hold/Delay mode)

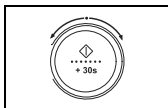

2. Select the standing time by turning the **dial knob**.

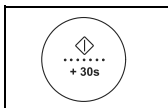

3. Press **Start** () button.
Result: The oven beeps when the standing time is over.

Choosing the Accessories

Traditional convection cooking does not require any special cookware. You should, however, use only cookware that you would use in your normal oven.

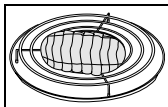

Microwave-safe containers are not usually suitable for convection cooking; don't use plastic containers, dishes, paper cups, towels, etc.

If you wish to select a combined cooking mode (microwave and grill or convection), use only recipients that are microwave-safe and oven-proof. Metallic cookware or utensils may damage your oven.



For further details on suitable cookware and utensils, refer to the Cookware Guide on page 24 .

Preheating the Oven

For convection cooking, it is recommended that you preheat the oven to the appropriate temperature before placing the food in the oven.

When the oven reaches the requested temperature, it is maintained for approximately 10 minutes; it is then switched off automatically.

Check that the heating element is in the correct position for the type of cooking that you require. Open the door and place the turntable.

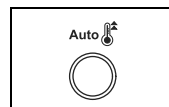

1. Press the **PREHEAT** () button.
Result: The following indications are displayed:
250°C (temperature)

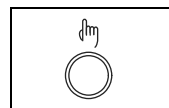

2. Press the **Select** () button once or more times to set the temperature.

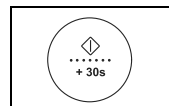

3. Press the **Start** () button.
Result: The oven is preheated to the requested temperature.

Cooking by Convection

The convection mode enables you to cook food in the same way as in a traditional oven. The microwave mode is not used. You can set the temperature, as required, in a range varying from 40°C to 250°C in eight preset levels. The maximum cooking time is 60 minutes.

- ☞ If you wish to preheat the oven, see page 18.
- Always use oven gloves when touching the recipients in the oven, as they will be very hot.
 - You can get better cooking and browning, if you use the low rack.

Check that the heating element is in the horizontal position and that the turntable is in position. Open the door and place the recipient on the turntable.

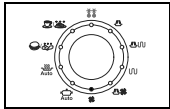

1. Turn the **Cooking Control knob** to the **Convection** () symbol.

Result: The following indications are displayed:

 (convection mode)
250°C (temperature)

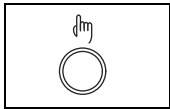

2. Press the **Select** () button once or more times to set the temperature.

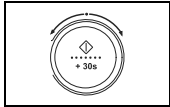

3. Set the cooking time by turning the **dial knob**.

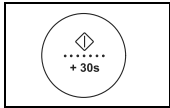

4. Press the **Start** () button.

Result: Cooking starts:

- ◆ When cooking has finished, the oven will beep and flash "0" four times. The oven will then beep one time per minute.

- ☒ You can check the temperature at any time by pressing the **Language** button.

Grilling

The grill enables you to heat and brown food quickly, without using microwaves.

- Always use oven gloves when touching the recipients in the oven, as they will be very hot.
- You can get better cooking and grilling results, if you use the high rack.

Check that the heating element is in the horizontal position, and that the appropriate rack is in position.

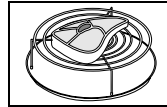

1. Open the door and place the food on the rack.

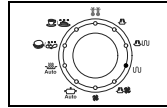

2. Turn the **Cooking Control knob** to the **Grill** () symbol.

Result: The following indications are displayed:
| (one-stage cooking)
 (grill mode)

- You cannot set the temperature of the grill.

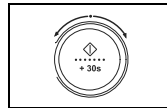

3. Set the grilling time by turning the **dial knob**.
- The maximum grilling time is 60 minutes.

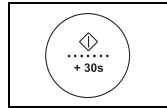

4. Press the **Start** () button.

Result: Grilling starts:

- ◆ When cooking has finished, the oven will beep and flash "0" four times. The oven will then beep one time per minute.

Choosing the Heating Element Position

GB

The heating element is used when grilling. There is only one position listed. We need to tell consumers when it should be placed in the vertical position.

The heating element is used when cooking food by convection, grilling or spit roasting. It can be placed in one of two positions:

- **Horizontal position for convection cooking and grilling**
- **Vertical position for spit roasting only (C108STB/C108STF/ C109STB/C109STF)**

☞ Only change the position of the heating element when it is cold and do not apply excessive force when placing it in the vertical position.

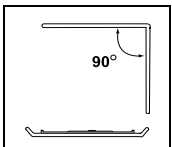
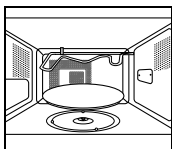

To set the heating element to the...	Then...
Vertical position (spit roasting only : C108STB/C108STF/ C109STB/C109STF)	<ul style="list-style-type: none"> ◆ Pull down on the heating element ◆ Push it towards the back of the oven until it is parallel with the back wall
Horizontal position (convection cooking and grilling)	<ul style="list-style-type: none"> ◆ Pull the heating element towards you ◆ Push it upwards until it is parallel with the roof of the oven

Spit-Roasting

C108STB / C108STF / C109STB / C109STF only

The roasting spit is useful for barbecue cooking, as you do not need to turn the meat over. It can be used for combined microwave and Convection cooking.

☞ Make sure that the weight of the meat is evenly distributed on the spit and that the spit rotates freely.
Always use oven gloves when touching the recipients in the oven, as they will be very hot.

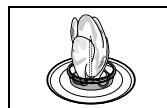

1. Push the roasting spit through the centre of the meat.
Example: Push the spit between the backbone and breast of a chicken.
Place the spit on its stand and place the stand onto the glass bowl and the glass bowl onto the turntable. To help brown the meat, brush it with cooking oil.

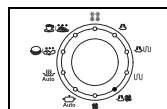

2. Turn the **Cooking Control knob** to the **Combi** (☞☞) symbol.

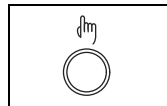

3. Set the temperature by pressing the **Select** (☞) button.

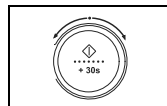

4. Set the cooking time by turning the **dial knob**.
 - The maximum cooking time is 60 minutes.

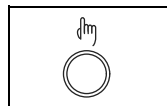

5. Select the appropriate power level by pressing the **Select** (☞) button.

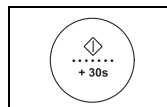

6. Press the **Start** (◆) button.
Result: Cooking starts and the spit rotates.

- ◆ When cooking has finished, the oven will beep and flash "0" four times. The oven will then beep one time per minute.

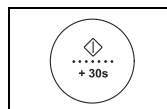

7. When the meat has been fully cooked, carefully remove the spit, using oven gloves to protect your hands.

Using The Vertical Multi-Spit

C108STB / C108STF / C109STB / C109STF only

MULTI-SPIT FOR KEBAB

Using the multi-spit with 6 kebab skewers you can easily barbecue meat, poultry, fish, vegetables (like onions, peppers or courgettes) and fruit which have been cut into pieces.

You can prepare the above food with the kebab skewers by using convection or combination mode.

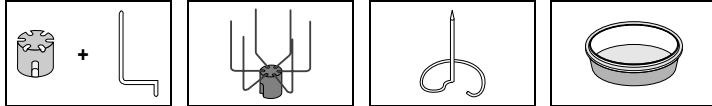

**Coupler
Barbecue,
Skewer,**

Multi-Spit

Roasting-Spit

Glass Bowl

USE OF THE MULTI-SPIT WITH KEBAB SKEWERS

1. For preparing kebabs with the multi-spit use the 6 skewers.
2. Put the same amount of food on each skewer.
3. Place the roasting- spit into the glass bowl and insert the multi-spit into it.
4. Put the glass bowl with the multi-spit in the centre of the turntable.

- ☒ Make sure that the grill heating element is in the right position at the back wall of the cavity and not at the top before starting the grilling process.

REMOVING THE MULTI-SPIT FROM THE OVEN AFTER GRILLING

1. Use oven gloves for taking for glass bowl with the multi-spit out of the oven, because it will be very hot.
2. Remove multi-spit out of the spit stand by using oven gloves as well.
3. Carefully remove the skewers and use a fork for removing the food pieces from the skewers.

- ☒ The multi--is not suitable for cleaning in the dishwasher. Therefore clean it with warm water and washing up liquid by hand. Remove the vertical multi-spit from the oven, after use.

Combining Microwaves and the Grill

You can also combine microwave cooking with the grill, to cook quickly and brown at the same time.



ALWAYS use microwave-safe and oven-proof cookware. Glass or ceramic dishes are ideal as they allow the microwaves to penetrate the food evenly.

ALWAYS use oven gloves when touching the recipients in the oven, as they will be very hot.

You can improve cooking and grilling, if you use the high rack.

- **Open the door. Place the food on the rack best suited to the type of food to be cooked. Place the rack on the turntable. Close the door.**

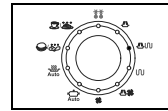

1. Turn the **Cooking Control knob** to the **Combi (MW+Grill)** symbol.

Result: The following indications are displayed:

- | (one - stage cooking)
- ⏱ (microwave & grill combi mode)

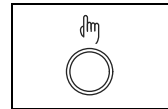

2. Select the appropriate power level by pressing the **Select** () button until the corresponding output power is displayed (300-600W).

- You cannot set the temperature of the grill.

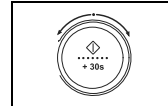

3. Set the cooking time by turning the **dial knob**.

- The maximum cooking time is 60 minutes.

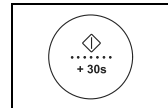

4. Press the **Start** () button.

Result:

- ◆ Combination cooking starts.
- ◆ When cooking has finished, the oven will beep and flash "0" four times. The oven will then beep one time per minute.

Combining Microwaves and Convection

GB

Combination cooking uses both microwave energy and convection heating. No preheating is required as the microwave energy is immediately available.

Many foods can be cooked in combination mode, particularly:

- Roast meats and poultry
- Pies and cakes
- Egg and cheese dishes



ALWAYS use microwave-safe and oven-proof cookware. Glass or ceramic dishes are ideal as they allow the microwaves to penetrate the food evenly.

ALWAYS use oven gloves when touching the recipients in the oven, as they will be very hot.

You can get better cooking and browning, if you use the low rack.

Open the door . Place the food on the turntable or on the low rack which should then be placed on the turntable. Close the door. The heating element must be in the horizontal position.

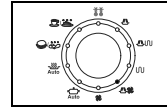

1. Turn the **Cooking Control knob** to the **Combi (MW+Convection)** symbol.

Result: The following indications are displayed:
 (microwave & convection combi mode)
250°C (temperature)

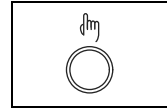

2. Select the temperature by pressing the **Select** () button.

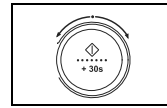

3. Set the cooking time by turning the **dial knob**.
 - The maximum cooking time is 60 minutes.

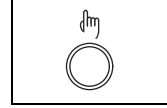

4. Select the appropriate power level by pressing the **Select** () button until the corresponding output power is displayed (100-600W).

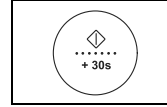

5. Press the **Start** () button.

Result:

- ◆ Combination cooking starts.
- ◆ The oven is heated to the required temperature and then microwave cooking continues until the cooking time is over.
- ◆ When cooking has finished, the oven will beep and flash "0" four times. The oven will then beep one time per minute.



If you would like to know the current temperature of the oven cavity, press the **Language** button.

Safety-locking Your Microwave Oven

Your microwave oven is fitted with a special Child Safety programme, which enables the oven to be “locked” so that children or anyone unfamiliar with it cannot operate it accidentally.

The oven can be locked at any time.

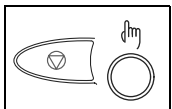

1. Press the **Stop** (⏹) and **Select** (⏸) buttons at the same time (about one second).

Result:

- ◆ The oven is locked.
- ◆ The icon (🔒) is displayed.

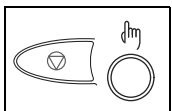

2. To unlock the oven, press the **Stop** (⏹) and **Select** (⏸) buttons again at the same time (about one second).

Result:

- ◆ The icon (🔒) is no longer displayed.
- ◆ The oven can be used normally.

Scroll Speed

Your can control the scroll speed whenever you want.

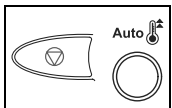

1. Press the **Stop** (⏹) and **Preheat** (Auto ⏸) buttons at the same time (about one second).

Result: The numbers “11111” - “55555” are displayed.

2. Select the appropriate scroll speed.

☒ “11111” means the low scroll speed, and “55555” means the high scroll speed.

Switching the Beeper Off

You can switch the beeper off whenever you want.

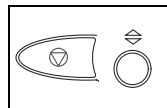

1. Press the **Turntable Stop** (⏹) and **More/Less** (⏪) buttons at the same time (about one second).

Result: The oven does not beep to indicate the end of a function.

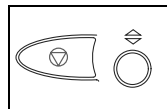

2. To switch the beeper back on, press the **Stop** (⏹) and **More/Less** (⏪) buttons again at the same time (about one second).

Result: The oven operates normally.

Manual Stop Turntable Function

The turntable on/off (⏸) button enables you to use large dishes which fill the whole oven by stopping the turntable from rotating (only manual cooking mode).

☞ The results will be less satisfactory in this case as the cooking is less even. We recommend that you turn the dish by hand halfway through the cooking process.

Warning ! Never operate the turntable without food in the oven.

Reason: This may cause fire or damage to the unit.

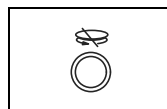

1. Press the **Turntable on/off** (⏸) button.

Result: The turntable will not rotate.

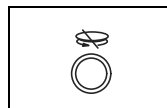

2. To switch the turntable rotating back on, press the **Turntable on/off** (⏸) button again.

Result: The turntable will rotate.

☒ Do not press the **Turntable on/off** (⏸) button during the cooking process. Cancel the cooking phase, before pressing the **turntable On/Off** button.

Cookware Guide

GB

To cook food in the microwave oven, the microwaves must be able to penetrate the food, without being reflected or absorbed by the dish used.

Care must therefore be taken when choosing the cookware. If the cookware is marked microwave-safe, you do not need to worry.

The following table lists various types of cookware and indicates whether and how they should be used in a microwave oven.

Cookware	Microwave-Safe	Comments
Aluminium foil	✓ X	Can be used in small quantities to protect areas against overcooking. Arcing can occur if the foil is too close to the oven wall or if too much foil is used.
Crusting plate	✓	Do not preheat for more than 8minutes.
China and earthenware	✓	Porcelain, pottery, glazed earthenware and bone china are usually suitable, unless deco-rated with a metal trim.
Disposable polyester cardboard dishes	✓	Some frozen foods are packaged in these dishes.
Fast-food packaging		
• Polystyrene cups containers	✓	Can be used to warm food. Overheating may cause the polystyrene to melt.
• Paper bags or newspaper	X	May catch fire.
• Recycled paper or metal trims	X	May cause arcing.
Glassware		
• Oven-to-table ware	✓	Can be used, unless decorated with a metal trim. Can be used to warm foods or liquids.
• Fine glassware	✓	Delicate glass may break or crack if heated suddenly.
• Glass jars	✓	Must remove the lid. Suitable for warming only.
Metal		
• Dishes	X	May cause arcing or fire.
• Freezer bag twist ties	X	

Paper

- Plates, cups, napkins and Kitchen paper ✓ For short cooking times and warming. Also to absorb excess moisture.
- Recycled paper X May cause arcing.

Plastic

- Containers ✓ Particularly if heat-resistant thermoplastic. Some other plastics may warp or discolour at high temperatures. Do not use Melamine plas-tic. Can be used to retain moisture. Should not touch the food. Take care when removing the film as hot steam will escape.
- Cling film ✓ Only if boilable or oven-proof. Should not be airtight. Prick with a fork, if necessary.
- Freezer bags ✓ X

Wax or grease-proof paper

- ✓ Can be used to retain moisture and prevent spattering.

✓ :Recommended

✓X :Use Caution

X :Unsafe

Cooking Guide

MICROWAVES

Microwave energy actually penetrates food, attracted and absorbed by its water, fat and sugar content.

The microwaves cause the molecules in the food to move rapidly. The rapid movement of these molecules creates friction and the resulting heat cooks the food.

COOKING

Cookware for microwave cooking:

Cookware must allow microwave energy to pass through it for maximum efficiency. Microwaves are reflected by metal, such as stainless steel, aluminium and copper, but they can penetrate through ceramic, glass, porcelain and plastic as well as paper and wood. So food must never be cooked in metal containers.

Food suitable for microwave cooking:

Many kinds of food are suitable for microwave cooking, including fresh or frozen vegetables, fruit, pasta, rice, grains, beans, fish, and meat. Sauces, custard, soups, steamed puddings, preserves, and chutneys can also be cooked in a microwave oven. Generally speaking, microwave cooking is ideal for any food that would normally be prepared on a hob. Melting butter or chocolate, for example (see the chapter with tips, techniques and hints).

Covering during cooking

To cover the food during cooking is very important, as the evaporated water rises as steam and contributes to cooking process. Food can be covered in different ways: e.g. with a ceramic plate, plastic cover or microwave suitable cling film.

Standing times

After cooking is over food the standing time is important to allow the temperature to even out within the food.

Cooking Guide for frozen vegetables

Use a suitable glass pyrex bowl with lid. Cook covered for the minimum time - see table. Continue cooking to get the result you prefer.

Stir twice during cooking and once after cooking. Add salt, herbs or butter after cooking. Cover during standing time.

Food	Portion	Power	Time (min.)	Standing Time(min.)	Instructions
Spinach	150g	600W	5-6	2-3	Add 15 ml (1 tablespoon) cold water.
Broccoli	300g	600W	8-9	2-3	Add 30 ml (2 tbsp.) cold water.

Food	Portion	Power	Time (min.)	Standing Time(min.)	Instructions
Peas	300g	600W	7-8	2-3	Add 15 ml (1 tbsp.) cold water.
Green Beans	300g	600W	7½-8½	2-3	Add 30 ml (2 tbsp.) cold water.
Mixed Vegetables (carrots/peas/corn)	300g	600W	7-8	2-3	Add 15 ml (1 tbsp.) cold water.
Mixed Vegetables (Chinese style)	300g	600W	7½-8½	2-3	Add 15 ml (1 tbsp.) cold water.

Cooking Guide for rice and pasta

Rice: Use a large glass pyrex bowl with lid – rice doubles in volume during cooking. Cook covered. After the cooking time is over, stir before standing time and salt or add herbs and butter. Remark: the rice may not have absorbed all water after the cooking time is finished.

Pasta: Use a large glass pyrex bowl. Add boiling water, a pinch of salt and stir well. Cook uncovered. Stir occasionally during and after cooking. Cover during standing time and drain thoroughly afterwards.

Food	Portion	Power	Time (min.)	Standing Time(min.)	Instructions
White Rice (parboiled)	250g 375g	900W	15-16 17½-18½	5	Add 500 ml cold water. Add 750 ml cold water.
Brown Rice (parboiled)	250g 375g	900W	20-21 22-23	5	Add 500 ml cold water. Add 750 ml cold water.
Mixed Rice (rice + wild rice)	250g	900W	16-17	5	Add 500 ml cold water.
Mixed Corn (rice + grain)	250g	900W	17-18	5	Add 400 ml cold water.
Pasta	250g	900W	10-11	5	Add 1000 ml hot water.

GB

Cooking Guide (continued)

GB

Cooking Guide for fresh vegetables

Use a suitable glass pyrex bowl with lid. Add 30-45 ml cold water (2-3 tbsp.) for every 250 g unless another water quantity is recommended – see table. Cook covered for the minimum time – see table. Continue cooking to get the result you prefer. Stir once during and once after cooking. Add salt, herbs or butter after cooking. Cover during a standing time of 3 minutes.

Hint: Cut the fresh vegetables into even sized pieces. The smaller they are cut, the quicker they will cook.

All fresh vegetables should be cooked using full microwave power (900W).

Food	Portion	Time (min.)	Standing Time (min.)	Instructions
Broccoli	250g 500g	4½-5 7-8	3	Prepare even sized florets. Arrange the stems to the centre.
Brussels Sprouts	250g	6-6½	3	Add 60-75 ml (5-6 tbsp.) water.
Carrots	250g	4½-5	3	Cut carrots into even sized slices.
Cauliflower	250g 500g	5-5½ 7½-8½	3	Prepare even sized florets. Cut big florets into halves. Arrange stems to the centre.
Courgettes	250g	4-4½	3	Cut courgettes into slices. Add 30 ml (2 tbsp.) water or a knob of butter. Cook until just tender.
Egg Plants	250g	3½-4	3	Cut egg plants into small slices and sprinkle with 1 tablespoon lemon juice.
Leeks	250g	4-4½	3	Cut leeks into thick slices.
Mushrooms	125g 250g	1½-2 2½-3	3	Prepare small whole or sliced mushrooms. Do not add any water. Sprinkle with lemon juice. Spice with salt and pepper. Drain before serving.
Onions	250g	5-5½	3	Cut onions into slices or halves. Add only 15 ml (1 tbsp.) water.
Pepper	250g	4½-5	3	Cut pepper into small slices.
Potatoes	250g 500g	4-5 7-8	3	Weigh the peeled potatoes and cut them into similar sized halves or quarters.
Turnip Cabbage	250g	5½-6	3	Cut turnip cabbage into small cubes.

REHEATING

Your microwave oven will reheat food in a fraction of the time that conventional ovens and hobs normally take.

Use the power levels and reheating times in the following chart as a guide. The times in the chart consider liquids with a room temperature of about +18 to +20°C or a chilled food with a temperature of about +5 to +7°C.

Arranging and covering

Avoid reheating large items such as joint of meat - they tend to overcook and dry out before the centre is piping hot. Reheating small pieces will be more successful.

Power levels and stirring

Some foods can be reheated using 900 W power while others should be reheated using 600 W, 450 W or even 300 W.

Check the tables for guidance.

In general, it is better to reheat food using a lower power level, if the food is delicate, in large quantities, or if it is likely to heat up very quickly (mince pies, for example).

Stir well or turn food over during reheating for best results. When possible, stir again before serving.

Take particular care when heating liquids and baby foods. To prevent eruptive boiling of liquids and possible scalding, stir before, during and after heating. Keep them in the microwave oven during standing time. We recommend putting a plastic spoon or glass stick into the liquids. Avoid overheating (and therefore spoiling) the food. It is preferable to underestimate cooking time and add extra heating time, if necessary.

Heating and standing times

When reheating food for the first time, it is helpful to make a note of the time taken - for future reference.

Always make sure that the reheated food is piping hot throughout.

Allow food to stand for a short time after reheating - to let the temperature even out. The recommended standing time after reheating is 2-4 minutes, unless another time is recommended in the chart.

Take particular care when heating liquids and baby food. See also the chapter with the safety precautions.

REHEATING LIQUIDS

Always allow a standing time of at least 20 seconds after the oven has been switched off to allow the temperature to even out. Stir during heating, if necessary, and ALWAYS stir after heating. To prevent eruptive boiling and possible scalding, you should put a spoon or glass stick into the beverages and stir before, during and after heating.

Cooking Guide (continued)

REHEATING BABY FOOD

BABY FOOD:

Empty into a deep ceramic plate. Cover with plastic lid. Stir well after reheating! Let stand for 2-3 minutes before serving. Stir again and check the temperature. Recommended serving temperature: between 30-40°C.

BABY MILK:

Pour milk into a sterilised glass bottle. Reheat uncovered. Never heat a baby's bottle with teat on, as the bottle may explode if overheated. Shake well before standing time and again before serving! Always carefully check the temperature of baby milk or food before giving it to the baby. Recommended serving temperature: ca. 37°C.

REMARK:

Baby food particularly needs to be checked carefully before serving to prevent burns. Use the power levels and times in the next table as a guide lines for reheating.

Reheating Baby Food and Milk

Use the power levels and times in this table as guide lines for reheating.

Food	Portion	Power	Time	Standing Time(min.)	Instructions
Baby food (vegetables + meat)	190g	600W	30sec.	2-3	Empty into ceramic deep plate. Cook covered. Stir after cooking time. Stand for 2-3 minutes. Before serving, stir well and check the temperature carefully.
Baby porridge (grain + milk + fruit)	190g	600W	20sec.	2-3	Empty into ceramic deep plate. Cook covered. Stir after cooking time. Stand for 2-3 minutes. Before serving, stir well and check the temperature carefully.
Baby milk	100ml 200ml	300W	30-40sec. 1min. 10 sec. to 1min. 20sec.	2-3	Stir or shake well and pour into a sterilised glass bottle. Place into the centre of turntable. Cook uncovered. Shake well and stand for at least 2 minutes. Before serving, shake well and check the temperature carefully.

Reheating Liquids and Food

Use the power levels and times in this table as a guide lines for reheating.

Food	Portion	Power	Time (min.)	Standing Time (min.)	Instructions
Drinks (coffee, tea and water)	150ml (1 cup) 300ml (2 cups) 450ml (3 cups) 600ml (4 cups)	900W	1-1½ 2-2½ 3-3½ 3½-4	1-2	Pour into cups and reheat uncovered: 1 cup in the centre, 2 cups opposite of each other, 3 cups in a circle. Keep in microwave oven during standing time and stir well.
Soup (chilled)	250 g 350 g 450 g 550 g	900W	2½-3 3-3½ 3½-4 4½-5	2-3	Pour into a deep ceramic plate or deep ceramic bowl. Cover with plastic lid. Stir well after reheating. Stir again before serving.
Stew (chilled)	350g	600W	4½-5½	2-3	Put stew in a deep ceramic plate. Cover with plastic lid. Stir occasionally during reheating and again before standing and serving.
Pasta with sauce (chilled)	350g	600W	3½-4½	3	Put pasta (e.g. spaghetti or egg noodles) on a flat ceramic plate. Cover with microwave cling film. Stir before serving.
Filled pasta with sauce (chilled)	350g	600W	4-5	3	Put filled pasta (e.g. ravioli, tortellini) in a deep ceramic plate. Cover with plastic lid. Stir occasionally during reheating and again before standing and serving.
Plated Meal (chilled)	350g 450g 550g	600W	4½-5½ 5½-6½ 6½-7½	3	Plate a meal of 2-3 chilled components on a ceramic dish. Cover with microwave cling-film.
Cheese Fondue ready-to-serve (chilled)	400g	600W	6-7	1-2	Put the ready-to-serve cheese fondue in a suitable sized glass pyrex bowl with lid. Stir occasionally during and after reheating. Stir well before serving.

Cooking Guide (continued)

GB

DEFROSTING

Microwaves are an excellent way of defrosting frozen food. Microwaves gently defrost frozen food in a short period of time. This can be of great advantage, if unexpected guests suddenly show up.

Frozen poultry must be thoroughly thawed before cooking. Remove any metal ties and take it out of any wrapping to allow thawed liquid to drain away.

Put the frozen food on a dish without cover. Turn over half way, drain off any liquid and remove any giblets as soon as possible. Check the food occasionally to make sure that it does not feel warm.

If smaller and thinner parts of the frozen food start to warm up, they can be shield by wrapping very small strips of aluminium foil around them during defrosting.

Should poultry start to warm up on the outer surface, stop thawing and allow it to stand for 20 minutes before continuing.

Leave the fish, meat and poultry to stand in order to complete defrosting. The standing time for complete defrosting will vary depending on the quantity defrosted. Please refer to the table below.

Hint: Flat food defrosts better than thick and smaller quantities need less time than bigger ones. Remember this hint while freezing and defrosting food.

For defrosting of frozen food with a temperature of about -18 to -20°C, use the following table as a guide.

All frozen food should be defrosted using defrosting power level (180 W).

Food	Portion	Time (min.)	Standing Time (min.)	Instructions
Meat				
Minced beef	200g 400g	6-7 10-12	15-30	Place the meat on a flat ceramic plate. Shield thinner edges with aluminium foil. Turn over after half of defrosting time!
Pork steaks	250g	7-8		
Poultry				
Chicken pieces	500g (2pc)	14-15	15-60	First, put chicken pieces first skin-side down, whole chicken first breast-side-down on a flat ceramic plate. Shield the thinner parts like wings and ends with aluminium foil. Turn over after half of defrosting time!
Whole chicken	1200g	32-34		
Fish				
Fish fillets	200g	6-7	10-25	Put frozen fish in the middle of a flat ceramic plate. Arrange the thinner parts under the thicker parts. Shield narrow ends with aluminium foil. Turn over after half of defrosting time!
Whole fish	400g	11-13		
Fruits				
Berries	250g	6-7	5-10	Spread fruit on a flat, round glass dish (with a large diameter).
Bread				
Bread rolls (each ca. 50 g)	2pc 4pc	1-1½ 2½-3	5-20	Arrange rolls in a circle or bread vertically (like a tower) on kitchen paper in the middle of turntable. Turn over after half of defrosting time!
Toast/ Sandwich	250g	4-4½		
German bread (wheat + rye flour)	500g	7-9		

Cooking Guide (continued)

GRILL

The grill-heating element is located underneath the ceiling of the cavity. It operates while the door is closed and the turntable is rotating. The turntable's rotation makes the food brown more evenly. Preheating the grill for 4 minutes will make the food brown more quickly.

Cookware for grilling:

Should be flameproof and may include metal. Do not use any type of plastic cookware, as it can melt.

Food suitable for grilling:

Chops, sausages, steaks, hamburgers, bacon and gammon rashers, thin fish portions, sandwiches and all kinds of toast with toppings.

IMPORTANT REMARK:

Whenever the grill only mode is used, make sure that the grill-heating element is under the ceiling in the horizontal position and not on the back-wall in the vertical position. Please remember that food must be placed on the high rack, unless another instruction is recommended.

MICROWAVE + GRILL

This cooking mode combines the radiant heat that is coming from the grill with the speed of microwave cooking. It operates only while the door is closed and the turntable is rotating. Due to the rotation of the turntable, the food browns evenly. Three combination modes are available with this model:
600 W + Grill, 450 W + Grill and 300 W + Grill.

Cookware for cooking with microwaves + grill

Please use cookware that microwaves can pass through. Cookware should be flameproof. Do not use metal cookware with combination mode. Do not use any type of plastic cookware, as it can melt.

Food suitable for microwaves + grill cooking:

Food suitable for combination mode cooking include all kinds of cooked food which need reheating and browning (e.g. baked pasta), as well as foods which require a short cooking time to brown the top of the food. Also, this mode can be used for thick food portions that benefit from a browned and crispy top (e.g. chicken pieces, turning them over half way through cooking). Please refer to the grill table for further details.

IMPORTANT REMARK:

Whenever the combination mode (microwave + grill) is used, make sure that the grill heating element is under the ceiling in the horizontal position and not on the back-wall in the vertical position. The food should be placed on the high rack, unless another instruction is recommended. Otherwise it has to be placed directly on the turntable. Please refer to the instructions in the following chart. The food must be turned over, if it is to be browned on both sides.

Grill guide for frozen food

Preheat the grill with the grill function for 3 minutes, unless indicated differently.

Use the power levels and times in this table as guide lines for grilling.

Food	Portion	Power	Time (min.)	Instructions
Burger (raw frozen)	2pieces (125 g) 4pieces (250 g)	450W+Grill	5-6 8-9	Put the raw burger in a circle on the high rack. Turn over after 3½ (125 g) and after 5 min. (250 g). Put burger into rolls.
Hamburger, Cheeseburger etc.(ready, cooked with bread roll)	2 pc (300 g)	600W+Grill without preheating!	5-6	Put frozen burger side by side on a flameproof dish. Place plate directly on the turntable. Stand for 2-3 minutes.
Gratin (vegetables or potatoes)	400 g	450W+Grill	13-15	Put frozen gratin into a round glass pyrex dish. Put the dish on the high rack. After cooking stand for 2-3 minutes.
Fish Gratin	400 g	450W+Grill	19-21	Put frozen fish gratin into a small flat rectangular glass pyrex dish. Put the dish on the low rack. After cooking stand for 2-3 minutes.

Cooking Guide (continued)

GB

Grill Guide for fresh food

Preheat the grill with the grill-function for 3 minutes.

Use the power levels and times in this table as guide lines for grilling.

Fresh Food	Portion	Power	1. Side Time (min.)	2. Side Time (min.)	Instructions
Toast Slices	4 pc (each 25g)	Grill only	3½-4½	3-4	Put toast slices side by side on the rack.
Grilled Tomatoes	200 g (2pc) 400 g (4pc)	300W+ Grill	4-5 5½-6½	-	Cut tomatoes into halves. Put some cheese on top. Arrange in a circle in a flat glass pyrex dish. Place it on the high rack. Stand for 2-3 minutes.
Tomato-Cheese Toast	4 pc (300 g)	300W+ Grill	4½-5½	-	Toast the bread slices first. Put the toast with topping on the high rack. Stand for 2-3 minutes
Toast Hawaii (ham, pineapple, cheese slices)	2 pc (300 g) 4 pc (500 g)	450W+ Grill	4-5 6½-7½	-	Toast the bread slices first. Put the toast with topping on the high rack. Put 2 toasts opposite directly on the high rack. Stand for 2-3 minutes.
Baked Potatoes	250 g 500 g	600W+ Grill	5-6 7½-8½	-	Cut potatoes into halves. Put them in a circle on the high rack with the cut side to the grill.
Gratin Potatoes / vegetables (chilled)	450 g	600W+ Grill	6½-7½	-	Put the fresh gratin into a small round glass pyrex dish. Put the dish on the high rack. After cooking stand for 2-3 minutes.
Baked Apples	2 apples (ca.400g) 4 apples (ca.800g)	300W+ Grill	6½-7½ 11-13	-	Core the apples and fill them with raisins and jam. Put some almond slices on top. Put apples on a flat glass pyrex dish. Place the dish directly on the low rack.

Fresh Food	Portion	Power	1. Side Time (min.)	2. Side Time (min.)	Instructions
Chicken Pieces	500 g (2pcs) 900 g (3-4pcs)	300W+ Grill	10-11 12-13	9-10 11-12	Brush chicken pieces with oil and spices. Put them in a circle on the high rack. Stand for 2-3 minutes
Lamb Chops (medium)	400 g (4pcs)	Grill only	10-12	8-9	Brush the lamb chops with oil and spices. Lay them in a circle on the high rack. After grilling stand for 2-3 minutes.
Pork Steaks	400 g (2pcs)	MW + Grill	300W+ Grill 8-9	Grill only 8-9	Brush the pork steaks with oil and spices. Lay them in a circle on the high rack. After grilling stand for 2-3 minutes.
Roast Fish	400-500 g	300W+ Grill	6-7	7-8	Brush skin of whole fish with oil and add herbs and spices. Put two fishes side by side (head to tail) on the high rack. Stand for 2-3 minutes.

Cooking Guide (continued)

CONVECTION

Cooking with convection is the traditional and well known method of cooking food in a traditional oven with hot air.

The heating element and the fan are situated on the back-wall, so that the hot air is circulating.

Cookware for convection cooking:

All conventional ovenproof cookware, baking tins and sheets – anything you would normally use in a traditional convection oven – can be used.

Food suitable for convection cooking:

All biscuits, individual scones, rolls and cakes should be made by this mode as well as rich fruit cakes, choux pastry and soufflés.

MICROWAVES + CONVECTION

This mode combines the microwave energy with the hot air and is therefore reducing the cooking time while giving the food a brown and crispy surface.

Cooking with convection is the traditional and well known method of cooking food in an oven with hot air circulated by a fan on the back-wall.

Cookware for cooking with microwaves + convection:

Should be able to let the microwaves pass through. Should be ovenproof (like glass, pottery or china without metal trims); similar to the cookware described under MW + Grill.

Food suitable for microwave + convection cooking:

All kinds of meats and poultry as well as casseroles and gratin dishes, sponge cakes and light fruit cakes, pies and crumbles, roast vegetables, scones and breads.

Convection Guide for fresh food like Pie/Quiche, Pizza and Meat

Preheat the convection with the preheating function to the desired temperature.

Use the power levels and times in this table as guide lines for convection cooking

Fresh Food	Portion	Power	1. Side Time (min.)	2. Side Time (min.)	Instructions
PIE/QUICHE Pie/Quiche (ready baked and chilled)	300g	300 W + 180°C	7-8	-	Put the chilled pie/quiche on baking paper on the high rack. Stand 2-3 minutes.
PIZZA Chilled Pizza (ready baked)	300-400g	600 W + 220°C	6-7	-	Place the pizza on the high rack. After baking stand for 2-3 minutes
MEAT Roast Beef/ Roast Lamb (medium)	1200-1300g	600W + 160°C	19-21	10-12	Brush beef/ lamb with oil and spice it with pepper, salt and paprika. Put it on the low rack, first with the fat side down. After cooking wrap in aluminium foil and stand for 10-15minutes.
Roast Chicken	900g	450 W + 220°C	13-15	9-10	Brush chicken with oil and spices. Put chicken first breast side down, second side breast side up on the low rack. Stand for 5 minutes.

Cooking Guide (continued)

GB

Convection Guide for fresh food like Bread Rolls, Bread and Cake

Preheat the convection with the preheating function to the desired temperature, unless we recommend not to preheat the oven- see table.

Use the power levels and times in this table as guide lines for convection cooking.

Food	Portion	Power	Time (min)	Instructions
BREAD ROLLS				
Bread Rolls (ready baked)	4-6 pc (each ca. 50 g)	Only convection 180°C	2-3	Put bread rolls in a circle on the low rack. Use oven gloves while taking out! Stand 2-3 minutes.
Bread Rolls (pre-baked)	4-6 pc (each ca. 50 g)	100 W + 200°C	6-7	Put bread rolls in a circle on the low rack. Use oven gloves while taking out! Stand 2-3 minutes.
Bread Rolls (chilled fresh yeast dough)	200 g (4 pc)	180 W + 220°C	9-10	Arrange bread rolls on baking paper in a circle on the high rack. Leave the centre clear. Use oven gloves while taking out! Stand 2-3 minutes.
Croissants (chilled ready-to-bake dough)	200 g (4 pc)	100 W + 220°C	11-13	Arrange bread rolls on baking paper in a circle on the high rack. Leave the centre clear. Use oven gloves while taking out! Stand 2-3 minutes.
BAGUETTES				
Baguette (pre-baked)	200 g (1pc)	180 W + 220°C	6-7	Put baguette on the high rack. Use oven gloves while taking out! Stand 2-3 minutes.
Garlic Bread (chilled, pre-baked)	200 g (1pc)	180 W + 220°C	7-8	Put the chilled baguette on baking paper on the high rack. After baking stand for 2-3 minutes.

Food	Portion	Power	Time (min)	Instructions
CAKE				
Marble Cake; (batter cake)	500g	180 W + 220°C without preheating	18-20	Put the fresh dough in a small, round, black metal baking dish (diameter 18 cm). Put the cake on the low rack. Stand for 5-10 minutes.
Marble Cake/ Lemon cake (fresh dough)	700g	180 W + 220°C without preheating!	24-26	Put the fresh dough in a rectangular glass or black metal baking dish (length 25 cm). Put the cake on the low rack. Stand for 5-10 minutes.
Sweet Pastries (chilled yeast dough)	250 g (5 pcs)	100 W + 200°C	10-12	Put fresh yeast pastries with raisins or chocolate cream filling on baking paper in a circle on the high rack. Stand for 3 minutes.
Filled Puff Pastries (chilled)	250 g (5-7 pcs)	180 W + 220°C	13-15	Fill fresh puff pastry dough with e.g. sausages, ham or vegetables. Put them in a circle on the high rack. Stand for 3 minutes.
Muffins (fresh dough)	6 x 70 g (400-450 g)	180 W + 200°C	14-16	Fill the fresh dough evenly in a ceramic muffin-dish, suitable for 6 medium sized muffins, or use 6 small, round glass pyrex dishes. Put the dish on the low rack. Stand for 5 min..

Cooking Guide (continued)

Convection guide for frozen food like Bread Rolls, Bread, Cake and Pastry

Preheat the convection with the preheating function until the desired temperature is reached, unless we recommend not to preheat the oven- see table.

Use the power levels and times in this table as guide lines for baking.

Food	Portion	Power	Time (min)	Instructions
Bread Rolls (ready baked)	4 pc (each ca. 50 g)	100 W + 180°C without preheating!	7-8	Arrange rolls in a circle on the low rack. Stand for 2-5 minutes.
Bread Rolls (prebaked)	4 pc (each ca. 50 g)	100 W + 200°C	7-8	Arrange rolls in a circle on the low rack. Stand for 2-5 minutes.
Croissants (ready baked)	4 pc (each ca. 60 g)	100 W + 180°C	8-9	Put the croissants on the high rack. After baking stand for 2-3 minutes.
Baguettes / Garlic Bread (pre-baked)	200-250 g (1pc)	180 W + 200°C	6-7	Put the frozen baguette on baking paper on the low rack. After baking stand for 2-3 minutes.
Baguettes + topping (e.g. tomatoes, cheese, ham, etc.)	250 g (2pcs)	450 W + 220°C	6-7	Put frozen baguettes side by side on the low rack. After baking stand for 2-3 minutes.
Whole German Bread (pre-baked)	500 g	180 W + 160°C without preheating!	15-17	Put the whole bread on the low rack. After baking stand for 5 minutes.
Cake Pieces (ready baked with fruit filling)	500-600 g	300 W + 160°C without preheating!	7-9	Set frozen cake pieces in a circle on the low rack. After baking stand for 5-10 minutes.
Cake (ready baked with fruit filling)	1200-1300 g	300 W + 160°C without preheating!	14-16	Put frozen cake on baking paper on the low rack. After baking stand for 10-20 minutes
Sweet Puff Pastries (raw dough)	250 g (5-6 pc)	180 W + 220°C	9-12	Put frozen pastry filled with fruit or jam on baking paper on the high rack. After bake-off stand for 2-3 minutes.

Convection guide for frozen Pizza, Pasta, Chips and Nuggets

Preheat the convection with the preheating function until the desired temperature is reached, unless we recommend not to preheat the oven- see table.

Use the power levels and times in this table as guide lines for baking.

Food	Portion	Power	Time (min)	Instructions
Pizza (pre-baked)	300-400 g 450-550 g	600 W + 220°C	10-11 11½-12½	Place one pizza on the low rack. After baking stand for 2-3 minutes
2 Pizzas (pre-baked)	600-700 g (each 300-350 g)	600 W + 220°C	14-15	Place one pizza on the low and one on the high rack. After baking stand for 2-3 minutes.
Pasta (Lasagne or Canneloni)	400 g	450 W + 200°C without preheating!	20-22	Put into a suitable sized glass pyrex dish or leave in the original packaging (take care that this is suitable for microwaves and oven heat). Put frozen lasagne on the low rack. After cooking stand for 2-3 minutes.
Pasta (Macaroni, Tortellini)	400 g	450 W + 200°C without preheating!	16-18	Put into a suitable sized glass pyrex dish or leave in the original packaging (take care that this is suitable for microwaves and oven heat). Put frozen pasta gratin on the low rack. After cooking stand for 2-3 minutes.
Chicken Nuggets	250 g	450 W + 200°C	6½-7½	Put chicken nuggets on the low rack. After cooking stand for 2-3 minutes.
Oven Chips	250 g	300 W + 230°C	15-17	Put oven chips directly on baking paper on the low rack. Turn them over after 2/3 of time.

Cooking Guide (continued)

SPECIAL HINTS

GB

MELTING BUTTER

Put 50 g butter into a small deep glass dish. Cover with plastic lid. Heat for 30-40 seconds using 900 W, until butter is melted.

MELTING CHOCOLATE

Put 100 g chocolate into a small deep glass dish. Heat for 3-5 minutes, using 450 W until chocolate is melted. Stir once or twice during melting. Use oven gloves while taking out!

MELTING CRYSTALLIZED HONEY

Put 20 g crystallized honey into a small deep glass dish. Heat for 20-30 seconds using 300 W, until honey is melted.

MELTING GELATINE

Lay dry gelatine sheets (10 g) for 5 minutes into cold water. Put drained gelatine into a small glass pyrex bowl. Heat for 1 minute using 300 W. Stir after melting.

COOKING GLAZE/ICING (FOR CAKE AND GATEAUX)

Mix instant glaze (approximately 14 g) with 40 g sugar and 250 ml cold water. Cook uncovered in a glass pyrex bowl for 3 ½ to 4 ½ minutes using 900 W, until glaze/icing is transparent. Stir twice during cooking.

COOKING JAM

Put 600 g fruits (for example mixed berries) in a suitable sized glass pyrex bowl with lid. Add 300 g preserving sugar and stir well. Cook covered for 10-12 minutes using 900 W. Stir several times during cooking. Empty directly into small jam glasses with twist-off lids. Stand on lid for 5 minutes.

COOKING PUDDING

Mix pudding powder with sugar and milk (500 ml) by following the manufacturers instructions and stir well. Use a suitable sized glass pyrex bowl with lid. Cook covered for 6 ½ to 7 ½ minutes using 900 W. Stir several times well during cooking.

BROWNING ALMOND SLICES

Spread 30 g sliced almonds evenly on a medium sized ceramic plate. Stir several times during browning for 3 ½ to 4 ½ minutes using 600 W. Let it stand for 2-3 minutes in the oven. Use oven gloves while taking out!

Cleaning Your Microwave Oven

The following parts of your microwave oven should be cleaned regularly to prevent grease and food particles from building up:

- *Inside and outside surfaces*
- *Door and door seals*
- *Turntable and Roller rings*

☞ **ALWAYS** ensure that the door seals are clean and the door closes properly.

1. Clean the outside surfaces with a soft cloth and warm, soapy water. Rinse and dry.
2. Remove any splashes or stains on the inside surfaces or on the roller ring with a soapy cloth. Rinse and dry.
3. To loosen hardened food particles and remove smells, place a cup of diluted lemon juice on the turntable and heat for ten minutes at maximum power.
4. Wash the dishwasher-safe plate whenever necessary.

☒ **DO NOT** spill water in the vents. **NEVER** use any abrasive products or chemical solvents. Take particular care when cleaning the door seals to ensure that no particles:

- Accumulate
- Prevent the door from closing correctly

Storing and Repairing Your Microwave Oven

A few simple precautions should be taken when storing or having your microwave oven serviced.

The oven must not be used if the door or door seals are damaged:

- Broken hinge
- Deteriorated seals
- Distorted or bent oven casing

Only a qualified microwave service technician should perform repairs.

- ✎ **NEVER** remove the outer casing from the oven. If the oven is faulty and needs servicing or you are in doubt about its condition:
 - Unplug it from the wall socket
 - Contact the nearest after-sales service centre
- ☒ If you wish to store your oven away temporarily, choose a dry, dust-free place.
 - **Reason:** Dust and damp may adversely affect the working parts in the oven.

Installation & Wiring Instructions

IMPORTANT NOTE :

The mains lead on this equipment is supplied with a moulded plug incorporating a fuse.

The value of the fuse is indicated on the pin face of the plug and, if it requires replacing, a fuse approved to BS1363 of the same rating must be used. Never use the plug with the fuse cover omitted if the cover is detachable. If a replacement fuse cover is required, it must be of the same colour as the pin face of the plug.

Replacement covers are available from your Dealer. If the fitted plug is not suitable for the power points in your house or the cable is not long enough to reach a power point, you should obtain a suitable safety approved extension lead or consult your Dealer for assistance. However, if there is no alternative to cutting off the plug, remove the fuse and then safely dispose of the plug. Do not connect the plug to a mains socket, as there is a risk of shock hazard from the bared flexible cord.

Wiring Instructions

WARNING THIS APPLIANCE MUST BE EARTHED.

This appliance must be earthed. In the event of an electrical short circuit, earthing reduces the risk of electric shock providing an escape wire for the electric current. The appliance is equipped with a mains lead which includes an earth wire for connecting to the earth terminal of your mains plug. The plug must be plugged into a socket that is properly installed and earthed.

- ✎ The wires in this mains lead are coloured in accordance with the following code:
 - Green-and yellow : Earth
 - Blue : Neutral
 - Brown : Live

- ◆ As the colours of the wires in the mains lead of this appliance may not correspond with the coloured markings identifying the terminals in your plug, proceed as follows.
- ◆ Connect the green-and yellow wire to the terminal in the plug marked with the letter E or the earth symbol (\perp) or coloured green or green-and-yellow.
- ◆ Connect the blue wire to the terminal marked with the letter N or coloured black.

- ✎ Consult a qualified electrician or service technician if in doubt about any of these instructions.

The manufacturer of this oven will not accept any liability for damage to persons or material for non observance of these requirements.

There are no user-serviceable parts inside the oven and if the mains lead of this appliance is damaged, it must only be replaced by qualified service personnel approved by the manufacturer because special tools are required.

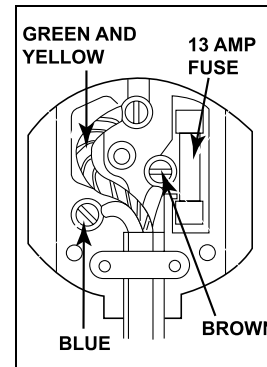

WARNING

Ensure that the plug and power cord are not damaged before use.

If you have any reason to remove the moulded plug from this appliance, immediately remove the fuse and dispose of the plug.

Do not connect the plug to a mains socket under any circumstances as there is a danger of electric shock.

CIRCUITS

Your microwave oven should be operated on a separate circuit from other appliances. Failure to do this may cause the circuit breaker to trip, the fuse to blow, or the food to cook more slowly.

Cooking Instructions On Food Packaging

Microwave Symbols

GB

On the front of your oven there is a microwave oven symbol, as shown below. This symbol has been introduced for your benefit when cooking or reheating packaged food.



Packaged food is also, increasingly, using a microwave symbol similar to the one below.

When you see this



Symbol on food packaging, the cooking instructions are based on either the IEC Power Output Rating, or the Reheating Categories A, B, C, D or E.

Cooking Instructions

The IEC Power Output rating is an internationally standardised rating, so all microwave manufacturers now use the same method of measuring power output. If food packaging gives cooking instructions based on IEC Power ratings, set cooking times according to the IEC Power of your oven.

For example :

If the cooking instructions are based on a 650W oven, then you will need to reduce some cooking time for the C108ST/C108STB/C108STT/C108STF/C109ST/C109STB/C109STT/C109STF (900W)

Ready meals are now very convenient and popular. These are meals which are already prepared and cooked by the food manufacturer, and then frozen, chilled or vacuum sealed for long life.

Increasingly, heating times for such ready meals are being based on the Heating Categories A, B, C, D and E.

On this instance, simply match the heating category of your oven to the instructions on the food package, and set your timer accordingly.

For example :

If the heating instructions are 3 minutes on HIGH for a D category oven, then you will need to set your timer for less than 3 minutes on HIGH for the C108ST/C108STB/C108STT/C108STF/C109ST/C109STB/C109STT/C109STF (E category).



Always remember that cooking instructions are intended only as a guide. If you have followed the instructions and the food is still not piping hot throughout, simply return it to the oven and cook it until it is.

Technical Specifications

SAMSUNG strives to improve its products at all times. Both the design specifications and these user instructions are thus subject to change without notice.

Power source	230V ~ 50 Hz AC
Power consumption	
Maximum power	3100 W
Microwave	1400 W
Grill (heating element)	1300 W
Convection (heating element)	1700 W
Output power	100 W / 900 W - 6 levels (IEC-705) <ul style="list-style-type: none">• 240 V : 900 W• 230 V : 850 W
Operating frequency	2450 MHz
Dimensions (W x D x H)	
Outside	517 x 520 x 310 mm
Oven cavity	336 x 346 x 222 mm
Volume	1.0 Cubic feet
Weight	
Shipping	24.5 kg approx.
Net	22.5 kg approx.

SAMSUNG
ELECTRONICS