

**SAMSUNG**

**GT-S7530**  
user manual



# Using this manual

Thank you for purchasing this Samsung mobile device. This device will provide you with high quality mobile communication and entertainment based on Samsung's exceptional technology and high standards.

This user manual has been specially designed to guide you through the functions and features of your device.

## Read me first

- Please read all safety precautions and this manual carefully before using your device to ensure safe and proper use.
- The descriptions in this manual are based on the default settings of your device.
- Images and screenshots used in this user manual may differ in appearance from the actual product.
- Content in this user manual may differ from the product, or from software provided by service providers or carriers, and is subject to change without prior notice. Refer to [www.samsung.com](http://www.samsung.com) for the latest version of the user manual.
- Available features and additional services may vary by device, software, or service provider.
- Formatting and delivery of this user manual is based on Windows operating systems and may vary depending on the user's operating system.
- Applications on this device may perform differently from comparable PC applications and may not include all functions available in the PC version.
- Applications and their functions may vary by country, region, or hardware specifications. Samsung is not liable for performance issues caused by third-party applications.

- Samsung is not liable for performance issues or incompatibilities caused by edited registry settings or modified operating system software. Attempting to customise the operating system may cause your device or applications to work improperly.
- You may upgrade your mobile device's software by accessing [www.samsung.com](http://www.samsung.com).
- Software, sound sources, wallpapers, images, and other contents provided in this device are licenced for limited use between Samsung and their respective owners. Extracting and using these materials for commercial or other purposes is an infringement of copyright laws. Samsung is not liable for such copyright infringement by the user.
- This product includes certain free/open source software. The exact terms of the licences, disclaimers, acknowledgements and notices are available on the Samsung's website [opensource.samsung.com](http://opensource.samsung.com).
- Please keep this manual for future reference.

## Instructional icons

Before you start, familiarise yourself with the icons you will see in this manual:



**Warning**—situations that could cause injury to yourself or others



**Caution**—situations that could cause damage to your device or other equipment



**Note**—notes, usage tips, or additional information

- ▶ **Refer to**—pages with related information; for example: ▶ p. 12 (represents “see page 12”)
- **Followed by**—the order of options or menus you must select to perform a step; for example: In Menu mode, select **Settings** → **system** → **region+language** (represents **Settings**, followed by **system**, followed by **region+language**)
- [ ] **Square brackets**—device keys; for example: [  ] (represents the Home key)

## Copyright

Copyright © 2012 Samsung Electronics

This user manual is protected under international copyright laws.

No part of this user manual may be reproduced, distributed, translated, or transmitted in any form or by any means, electronic or mechanical, including photocopying, recording, or storing in any information storage and retrieval system, without the prior written permission of Samsung Electronics.

## Trademarks

- SAMSUNG and the SAMSUNG logo are registered trademarks of Samsung Electronics.
- This product includes software licensed from MS, an affiliate of the Microsoft Corporation. Microsoft and software bearing the Microsoft name are registered trademarks of the Microsoft Corporation.
- Bluetooth® is a registered trademark of the Bluetooth SIG, Inc. worldwide.
- Wi-Fi®, Wi-Fi CERTIFIED™, and the Wi-Fi logo are registered trademarks of the Wi-Fi Alliance.
- All other trademarks and copyrights are the property of their respective owners.

Windows®  
phone



**CE 0168** 

# Contents

<b>Assembling</b> .....	<b>9</b>
Unpack .....	9
Install the SIM or USIM card and battery .....	9
Charge the battery .....	11
Attach a hand strap (optional) .....	14
<b>Getting started</b> .....	<b>15</b>
Turn your device on and off .....	15
Get to know your device .....	16
Use the touch screen .....	20
Lock or unlock the touch screen and keys .....	21
Get to know the Start screen .....	22
Access applications .....	22
Customise your device .....	23
Enter text .....	26
Access help topics .....	28
<b>Communication</b> .....	<b>29</b>
Calling .....	29
Messaging .....	34
Email .....	36
ChatON .....	39
<b>Entertainment</b> .....	<b>40</b>
Camera .....	40
Photo Studio .....	45
FunShot .....	48

Pictures .....	49
Music+Videos .....	50
Games .....	56
<b>Personal information .....</b>	<b>57</b>
People .....	57
Calendar .....	60
<b>Web .....</b>	<b>62</b>
Internet Explorer .....	62
Maps .....	64
Marketplace .....	66
Now .....	67
<b>Connectivity .....</b>	<b>70</b>
Bluetooth .....	70
WiFi .....	71
AllShare .....	72
Mobile network sharing .....	73
GPS .....	74
<b>Tools .....</b>	<b>75</b>
Alarms .....	75
Calculator .....	76
MiniDiary .....	76
Office .....	77
Search .....	81
Voice command .....	81
Wireless Manager .....	82

**Settings ..... 83**  
    Access the Settings menu ..... 83  
    system ..... 83  
    applications ..... 91

**Troubleshooting ..... 96**

**Safety precautions ..... 102**

**Index ..... 113**





# Assembling

## Unpack

Check your product box for the following items:

- Mobile device
- Battery
- Quick start guide

 Use only Samsung-approved software. Pirated or illegal software may cause damage or malfunctions that are not covered by your manufacturer's warranty.

-  • The items supplied with your device and available accessories may vary depending on your region or service provider.
- You can purchase additional accessories from your local Samsung dealer.
  - The supplied accessories perform best for your device.
  - Accessories other than the supplied ones may not be compatible with your device.

## Install the SIM or USIM card and battery

When you subscribe to a cellular service, you will receive a Subscriber Identity Module (SIM) card, with subscription details, such as your personal identification number (PIN) and optional services. To use UMTS or HSDPA services, you can purchase a Universal Subscriber Identity Module (USIM) card.

To install the SIM or USIM card and battery,

- 1 If the device is on, press and hold the Power key, and then drag the lock screen down with your finger.
- 2 Remove the back cover.

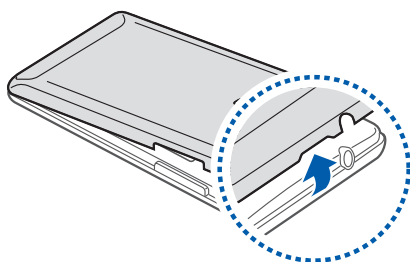

 Be careful not to damage your fingernails when you remove the back cover.

- 3 Insert the SIM or USIM card with the gold-coloured contacts facing down.

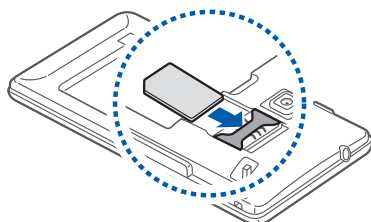

-  • The antenna is located in the upper area on the back of the device. Do not remove the protective tape covering the antenna, as this can damage the antenna.
- The SIM card slot of your device is only suited for standard SIM cards. Inserting a microSIM card or a microSIM card with an unauthorised holder may cause damage to the SIM card slot of your device.

4 Insert the battery.

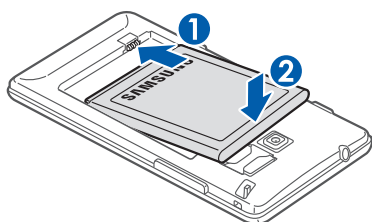

5 Replace the back cover.

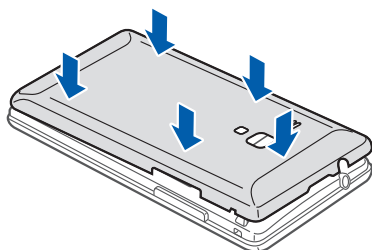

## Charge the battery

Before using the device for the first time or when the battery has been unused for an extended period, you must charge the battery.

You can charge the device with a travel adapter or by connecting the device to a PC with a USB cable.

 Use only Samsung-approved chargers and cables. Unauthorised chargers or cables can cause batteries to explode or damage your device.



- When your battery is low, the device will emit a warning tone and display a low battery message. The battery icon  will also be empty. If the battery level becomes too low, the device will automatically power off. Recharge your battery to continue using your device.
- If the battery is completely discharged, you cannot turn on the device, even with the travel adapter connected. Allow a depleted battery to charge for a few minutes before you try to turn on the device.

## › Charge with a travel adapter

- I* Plug the small end of the travel adapter into the multifunction jack.

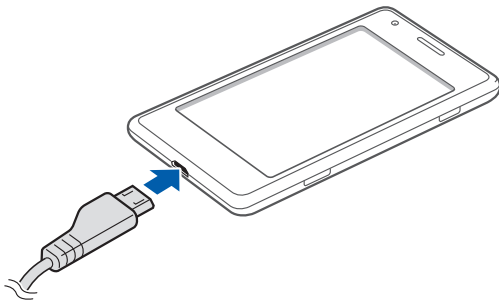

Connecting the travel adapter improperly may cause serious damage to the device. Any damage caused by misuse is not covered by the warranty.

2 Plug the large end of the travel adapter into a power outlet.



- You can use the device while it is charging, but it may take longer to fully charge the battery.
- While the device is charging, the touch screen may not function due to an unstable power supply. If this happens, unplug the travel adapter from the device.
- While charging, the device may heat up. This is normal and should not affect your device's lifespan or performance.
- If your device is not charging properly, bring your device and the charger to a Samsung Service Centre.

3 When the battery is fully charged, first unplug the travel adapter from the device and then from the power outlet.



Do not remove the battery before removing the travel adapter. Doing this may cause damage to the device.



To save energy, unplug the travel adapter when not in use. The travel adapter does not have a power switch, so you must unplug the travel adapter from the outlet when not in use to avoid wasting power. The device should remain close to the electrical socket while charging.

## › Charge with a USB cable

Before charging, ensure that your PC is turned on.

- 1 Plug one end (micro-USB) of the USB cable into the multifunction jack.
- 2 Plug the other end of the USB cable into a USB port on a PC.

 Depending on the type of USB cable you are using, it may take some time before charging begins.

- 3 When the battery is fully charged, first unplug the USB cable from the device and then from the PC.

## Attach a hand strap (optional)

- 1 Remove the back cover.
- 2 Slide a hand strap through the slot and hook it over the small projection.

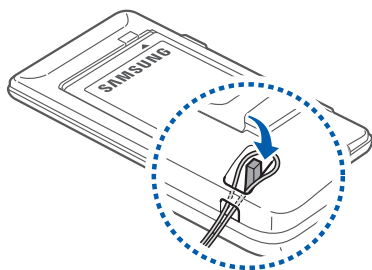

- 3 Replace the back cover.

# Getting started

## Turn your device on and off

To turn on your device, press and hold the Power key. If you turn on your device for the first time, follow the on-screen instructions to set up your device.

You can log in to Windows Live or create a Windows Live account to use applications that interact with the Windows Live server.

To turn off your device, press and hold the Power key, and then drag the lock screen down with your finger.



- Follow all posted warnings and directions from authorised personnel in areas where the use of wireless devices is restricted, such as aeroplanes and hospitals.
- To disable wireless features, switch to Flight mode. In Menu mode, select **Settings** → **system** → **flight mode**.

# Get to know your device

## › Device layout

### Front view

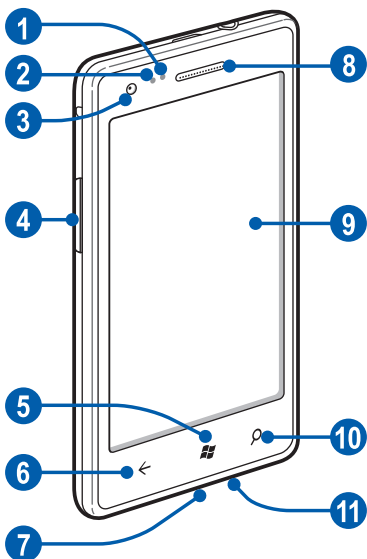

Number	Function
1	Proximity sensor
2	Light sensor
3	Front camera lens
4	Volume key
5	Home key
6	Back key
7	Multifunction jack





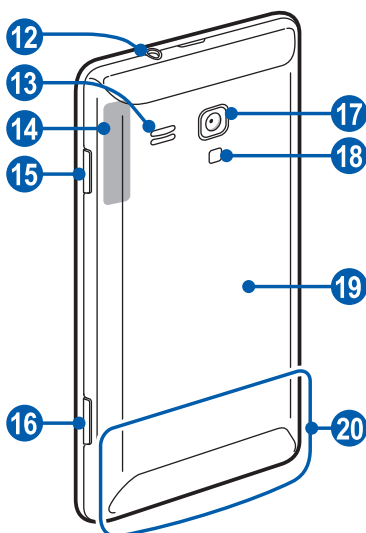

Number	Function
8	Earpiece
9	Touch screen
10	Search key
11	Mouthpiece

## Rear view









Number	Function
12	Headset jack
13	Speaker
14	GPS antenna <sup>1</sup>
15	Power/Reset/Lock key
16	Camera key

1. Do not touch or cover the area around the antenna with your hands or other objects while using the GPS functions.

Number	Function
	Rear camera lens
	Flashbulb
	Back cover
	Main antenna

## › Keys

Key	Function
 Power/ Reset <sup>2</sup> / Lock	Turn on the device (press and hold); Reset the device (press and hold for 11-13 seconds); Lock the touch screen and switch to Sleep mode.
 Camera	In Idle mode, turn on the camera; In Camera mode, take a photo or record a video.
 Back	Return to the previous screen; View all active applications (press and hold).
 Home	Return to the Start screen; Launch the voice command feature (press and hold).
 Search	Launch the search application.
 Volume	Adjust the device's volume.



2. If your device has fatal errors or hang-ups, or freezes, you may need to reset the device to regain functionality.

## › Indicator icons





- Icons shown on the display may vary depending on your region or service provider.
- Some indicator icons may be hidden. To display hidden icons, tap the indicator icon area.

Icon	Definition
	No signal
	Signal strength
	GPRS network connected
	EDGE network connected
	UMTS network connected
	HSDPA network connected
	Wi-Fi AP activated
	Bluetooth device connected
	Call diverting activated
	No SIM or USIM card
	SIM or USIM card locked
	Roaming (outside of normal service area)
	Ringer on
	Silent mode activated
	Vibration mode activated
	Flight mode activated

Icon	Definition
	Battery power level
	Charging battery
10:00	Current time

## Use the touch screen

Your device's touch screen lets you easily select items or perform functions. Learn basic actions to use the touch screen.

-  Do not press the touch screen with your fingertips, or use sharp tools on the touch screen. Doing so may damage the touch screen or cause it to malfunction.
- Do not allow the touch screen to come into contact with other electrical devices. Electrostatic discharges can cause the touch screen to malfunction.
- Do not allow the touch screen to come into contact with water. The touch screen may malfunction in humid conditions or when exposed to water.
-  For optimal use of the touch screen, remove the screen protection film before using your device.
- Your touch screen has a layer that detects small electrical charges emitted by the human body. For best performance, tap the touch screen with your fingertip. The touch screen will not react to touches of sharp tools, such as a stylus or pen.

Control your touch screen with the following actions:

- Tap: Touch once with your finger to select or launch a menu, option, or application.
- Tap and hold: Tap an item and hold it for more than 2 seconds to open a pop-up option list.
- Drag: Tap and drag your finger up, down, left, or right to move to items on lists.
- Drag and drop: Tap and hold your finger on an item, and then drag your finger to move the item.
- Double-tap: Tap twice quickly with your finger to zoom in or out while viewing photos or web pages.
- Pinch: Place two fingers far apart, and then pinch them together.



- Your device turns off the touch screen when you do not use the device for a specified period. To turn on the screen, press the Power key.
- You can set the length of time the device waits before turning off the screen. In Menu mode, select **Settings** → **system** → **lock+wallpaper** → **Screen times out after**.

## Lock or unlock the touch screen and keys

You can lock the touch screen and keys to prevent any unwanted device operations. Press the Power key to lock the touch screen and keys. To unlock, turn on the screen by pressing the Power key, and then drag the lock screen up with your finger.



- You can activate the screen lock feature to prevent others from using or accessing your personal data and information saved in your device. ► p. 25

## Get to know the Start screen

When the device is in Idle mode, you will see the Start screen. From the Start screen, you can view indicator icons, shortcuts to applications, and other items.

### › Add items to the Start screen

You can customise the Start screen by adding shortcuts to applications or items in applications. To add items to the Start screen, tap and hold on the item and select **pin to start**.



### › Move items on the Start screen

- 1 Tap and hold an item to move.
- 2 Drag the item to the location you want when the item is magnified.
- 3 Press [←].

### › Remove items from the Start screen

- 1 Tap and hold an item to remove.
- 2 Select .
- 3 Press [←].

## Access applications

- 1 On the Start screen, select  or scroll left to access Menu mode.
- 2 Select an application.
- 3 Scroll left or right to a panel (if necessary).
- 4 Press [←] to return to the previous screen; Press [] to return to the Start screen.

## › Switch applications

Press and hold [←] to view open windows of all active applications. To switch between applications, select one from the windows of active applications.

## › Uninstall applications

You can uninstall add-on applications.

- 1 In Menu mode, tap and hold an application.
- 2 Select **uninstall**.
- 3 Follow the on-screen instructions.

## Customise your device

Get more from your device by customising it to match your preferences.

### › Change the language of the display

- 1 In Menu mode, select **Settings** → **system** → **region+language** → **Display language**.
- 2 Select a language you want.

### › Set the current time and date

- 1 In Menu mode, select **Settings** → **system** → **date+time**.
- 2 Drag the slider next to **Set automatically** to deactivate the auto time update feature.
- 3 Select your time zone, and set the time and date.



## › Adjust the device volume

Press the Volume key to adjust the volume of sounds.

## › Switch to Silent mode

To mute or unmute your device, press the Volume key and then select .



You can set the device to alert you to various events in Silent mode. In Menu mode, select **Settings** → **system** → **ringtones+sounds** and drag the slider next to **Vibrate**. When you switch to Silent mode,  will appear in place of .

## › Change your ringtone

1 In Menu mode, select **Settings** → **system** → **ringtones+sounds** → **Ringtone**.

2 Select a ringtone from the list.

To play the ringtone before setting it, select .

## › Change the display theme

1 In Menu mode, select **Settings** → **system** → **theme**.

2 Select colours for the background and the highlight.

## › Adjust the brightness of the display

1 In Menu mode, select **Settings** → **system** → **brightness**.

2 Drag the slider next to **Automatically adjust** to deactivate the auto brightness feature.

3 Select **Level** → a brightness level.



The brightness level of the display will affect how quickly the device consumes battery power.



## › Select a wallpaper for the lock screen

- 1 In Menu mode, select **Settings** → **system** → **lock+wallpaper**.
- 2 Select **change wallpaper** → an image folder → an image.
- 3 Select .

## › Lock your device

You can lock your device by activating the device password.

- 1 In Menu mode, select **Settings** → **system** → **lock+wallpaper**.
- 2 Drag the slider next to **Password**.
- 3 Enter a new password, enter the new password again, and then select **done**.
- 4 Select **Require a password after** and select the length of time the device waits before locking itself.

Once the device lock is enabled, you must enter the password each time you turn on the device or unlock the touch screen.



- If you forget your password, bring your device to a Samsung Service Centre to unlock it.
- Samsung is not responsible for any loss of passwords or private information or other damages caused by illegal software.

## › Lock your SIM or USIM card

You can lock your device by activating the PIN supplied with your SIM or USIM card.

- 1 In Menu mode, select **Settings** → **applications** → **phone**.
- 2 Drag the slider next to **SIM security**.
- 3 Enter your PIN and select **enter**.

Once the PIN lock is enabled, you must enter the PIN each time you turn on the device.



- If you enter an incorrect PIN too many times, your SIM or USIM card will be blocked. You must enter a PIN unlock key (PUK) to unblock the SIM or USIM card.
- If you block your SIM or USIM card by entering an incorrect PUK, bring the card to your service provider to unblock it.

## Enter text

You can enter text by selecting characters on the virtual keypad.



- You cannot enter text in some languages. To enter text, you should change the writing language to one of the supported languages. ► p. 87

## › Enter text with the QWERTY keypad

Enter text by selecting alphanumeric keys on the screen.

You can also use the following keys:

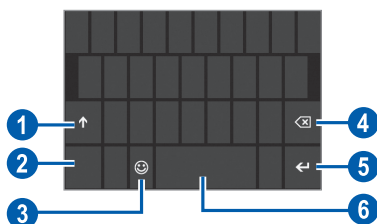



This screen may differ depending on applications.

Number	Function
1	Change case.
2	Switch between Number/Symbol mode and ABC mode.
3	Switch to Emoticon mode.
4	Clear your input.
5	Start a new line.
6	Insert a space.

## › Copy and paste text

While you are entering text, you can use the copy and paste feature to use text in other applications.

- 1 Tap a word you want to copy.
- 2 Drag ◀ or ▶ to select the text you want.
- 3 Select  to copy onto the clipboard.
- 4 In another application, place the cursor where you want to paste the text.
- 5 Select  to insert the text from the clipboard into the text field.

## Access help topics

Learn to get overall information on your device, and learn how to use your device and applications.

- 1 In Menu mode, select **Help+How-to**.
- 2 Select a category → a topic.

# Communication

## Calling

Learn to use calling functions, such as making and answering calls, using options available during a call or customising and using call-related features.

### › Make or answer a call

You can use the buttons or the touch screen when you make, accept, end, or reject calls.



- When you hold the device near your face, your device automatically turns off and locks the touch screen to prevent accidental inputs.
- Static electricity discharged from your body or clothing may interfere with the proximity sensor during a call.

### Make a call

To make a voice call,

- 1 In Menu mode, select **Phone** → , and enter an area code and a phone number.
- 2 Select **call** to make a call.
- 3 To end the call, select **end call**.

To make a video call,

- 1 In Menu mode, select **Video Call** → , and enter an area code and a phone number.
- 2 Select **video call** to make a call.
- 3 To end the call, select **end call**.



- If you cannot connect a video call, you can make a voice call or send a text message instead by selecting **Voice call** or .
- Use the phonebook to save numbers you dial frequently. ► p. 57
- To quickly access the voice call log to redial the numbers you dialled recently, select **Phone**. For the video call log, select **Video Call**.
- Use the voice command feature to dial by voice. ► p. 81

## Answer a call

1 When a call comes in, select **answer**.



When the device is ringing, press the Volume key to mute the ringtone.

2 To end the call, select **end call**.

## Reject a call

When a call comes in, select **ignore**. The caller will hear a busy tone.

## Call an international number

1 In Menu mode, select **Phone** or **Video Call** → , and tap and hold  to insert the + character.

2 Enter the complete number you want to dial (country code, area code and phone number), and then select **call** or **video call** to dial the number.



## › Use a headset

By plugging a headset into the device, you can control calls hands-free:

- To answer a call, press the headset button.
- To reject a call, press and hold the headset button.
- To place a call on hold or retrieve a held call during call, press and hold the headset button.
- To end a call, press the headset button.

## › Use options during a voice call

You can use the following options while a voice call is in progress:

- To adjust the voice volume, press the Volume key.
- To place a call on hold, select . To retrieve a held call, select  again.
- To dial a second call, select **add call** and then dial a new number.
- To answer a second call, select **answer** when a call waiting tone sounds. The first call is automatically placed on hold. You must subscribe to the call waiting service to use this feature.
- To open the dialling screen, select .
- To deactivate the speakerphone feature, select **speaker**.







In noisy environments, you may have difficulty hearing some calls while using the speakerphone feature. For better audio performance, use the normal phone mode.

- To turn off the microphone so that the other party cannot hear you, select **mute**.

- To make a multiparty call (conference call), make or answer a second call and select **merge calls** when connected to the second party. Repeat to add more parties. You must subscribe to the multiparty call service to use this feature.
- To open the phonebook, select .
- To switch between the two calls, select **PRESS TO SWAP**.

## › Use options during a video call

You can use the following options while a video call is in progress:

- To deactivate the speakerphone feature, select **speaker**.
- To turn off the microphone so that the other party cannot hear you, select **mute**.
- To change the ratio of the image, select .
- To hide your image from the other party, select .
- To switch between the front and rear camera lens, select .
- To adjust the image quality, select  → **quality**.
- To open the dialling screen, select  → **dialpad**.

## › View and dial missed calls

Your device will display calls you have missed. To dial the number of a missed call, select the missed call notification.

## › Use additional features

You can use various other call-related features, such as auto rejection or call diverting.



## Set auto rejection

Use auto rejection to reject calls from certain numbers automatically. To activate auto rejection and create auto reject lists,

- 1 In Menu mode, select **Settings** → **system** → **call blocking**.
- 2 Drag the slider next to **Block unknown calls**.
- 3 Select **add by keypad**.  
To add a phone number by selecting one from the phonebook, select **add from contacts**.
- 4 Enter a number and name, and then select **Criteria** → an option.
- 5 Select **Save** → **ok**.
- 6 To add more numbers, repeat steps 3-5.

## Set call forwarding

Call diverting is a network feature to send incoming calls to another number that you specify. You can set this feature separately for several conditions when you are not able to answer calls, such as when you are already on the phone or when you are outside of the service area.

- 1 In Menu mode, select **Wireless Manager** → **call** → **call forwarding** → a call type.
- 2 Select a condition → **On**.
- 3 Enter a number to which calls will be forwarded and select **Apply**.  
Your setting will be sent to the network.

## Set call waiting

Call waiting is a network feature to alert you of an incoming call while you are on a previous call. This feature is available only for voice calls.

In Menu mode, select **Wireless Manager** → **call** → **call waiting**. Your setting will be sent to the network.





## Messaging

Learn to create and send text (SMS) or multimedia (MMS) messages, and view or manage messages you have sent or received.







You may incur additional charges for sending or receiving messages while outside your home service area. For details, contact your service provider.

### › Send a text message

- 1 In Menu mode, select **Messaging** → **threads** → .
- 2 Select  on the recipient field and then select a contact, or enter a number manually.
- 3 Select the text field and enter your message text.  
To enter your message text by voice, select .
- 4 Select  to send the message.

### › Send a multimedia message

- 1 In Menu mode, select **Messaging** → **threads** → .
- 2 Select  on the recipient field and then select a contact, or enter a number or email address manually.

- 3 Select the text field and enter your message text.  
To enter your message text by voice, select .
- 4 Select  and add an image.
- 5 Select  to send the message.

## › View a text or multimedia message

- 1 In Menu mode, select **Messaging** → **threads**.  
Your messages are grouped by contact as a message thread.
- 2 Select a contact.

From the message thread view, use the following options:

- To forward the message to other people, tap and hold the message and select **forward**.
- To delete the message, tap and hold the message and select **delete**.
- To copy the message, tap and hold the message and select **copy**.
- To save the sender's number to the phonebook, select the sender's number at the top of the screen.

## › Chat with Windows Live Messenger

 If you connect your Facebook account to your Windows Live account, you can use Facebook chat.

- 1 In Menu mode, select **Messaging** → **online**.
- 2 Tap the screen and then select your status.
- 3 Chat with friends and family.

## › Listen to voice mail messages

If you have set missed calls to be diverted to the voice mail server, callers may leave voice messages when you do not answer incoming calls. To access your voice mail inbox and listen to voice mail messages,

1 In Menu mode, select **Phone** → .

2 Follow the instructions from the voice mail server.



You must save the voice mail server number before accessing the server. Your service provider can give you the number.

## Email

Learn to send or view email messages via your personal or company email account.

### › Set up an email account





1 In Menu mode, select **Settings** → **system** → **email+accounts** → **add an account**.

2 Select an email service.

3 Follow the on-screen instructions.

When you are finished setting up the email account, the shortcut to the email account is added to the Start screen and email messages are downloaded to your device.

## › Send an email message



- 1 In Menu mode, select an email account → .
- 2 Select  on the recipient field and then select a contact, or enter an email address manually.
- 3 Select the subject field and enter a subject.
- 4 Select the text field and enter your email text.
- 5 Select  and attach a file.
- 6 Select  to send the message.







If you are offline or outside your service area, the message will be held in the message thread list until you are online and in your service area.



## › View an email message

When you open an email account, you can view previously retrieved messages offline or retrieve new messages.

- 1 In Menu mode, select an email account.
- 2 Select  to update the message list.
- 3 Select  → **folders** → a message folder.
- 4 Select an email message.

From the message view, use the following options:

- To reply to the message, select  → **reply**.
- To reply to the message including all recipients, select  → **reply all**.
- To forward the message to other people, select  → **forward**.
- To delete the message, select .

- To view other messages in the current folder, select  or .
- To access additional features, select .
  - **toggle flag:** Add a flag to the message.
  - **mark as unread:** Mark the message as unread.
  - **move:** Move the message to another folder.

## › Customise the email settings

1 In Menu mode, select an email account →  → **settings**.

2 Adjust the following settings to customise the email account.

Option	Function
Synchronisation settings	Set the options for synchronising messages and the email server.
Conversations	Set whether or not to display messages on the conversation view.
Signature	Set whether or not to add your signature to your outgoing messages and create a signature.
Always bcc myself	Set whether or not to send a blind copy of messages to yourself.

3 When you are finished, select .

# ChatON

Learn to chat with your friends and family in ChatON. This is a global communication service based on mobile phone numbers, regardless device type or operating system. While having a conversation with your buddies, you can send various multimedia files and data, such as photos and contact numbers.

- 1 In Menu mode, select **ChatON**.
- 2 Follow the on-screen instructions to complete the account setup.
- 3 Chat with friends and family instantly.

# Entertainment

## Camera

Learn how to capture and view photos and videos. You can capture photos at resolutions up to 2592 x 1944 pixels (5 megapixels) and record videos at resolutions up to 640 x 480 pixels.



- The camera automatically turns off when you do not use it for a specified period.
- The memory capacity may differ depending on the shooting scene or shooting conditions.

### › Capture a photo

- 1 Press the Camera key to turn on the camera.
- 2 If you are launching this application for the first time, set whether or not to use your location.
- 3 Rotate the device to landscape view.
- 4 Aim the lens at the subject and make any necessary adjustments.





Number	Function
1	View the last photo or video you captured or recorded. This icon is available only when you take a photo.
2	Switch to the camcorder.
3	Switch between the front and rear camera lenses.
4	Zoom in or out.  The zoom function may be unavailable when shooting in the highest resolution.
5	Change the camera settings.

5 Select  → a flash option (, , .

6 Press the Camera key to capture a photo.

If you tap where you want to focus, the subject is in focus and the device takes a photo automatically.

The photo is saved automatically.

After capturing photos, select  to view the taken photos.

- To view more photos, scroll left or right.
- To zoom in, place two fingers on the screen and spread them apart. To zoom out, move your fingers closer together. You can also double-tap the screen.
- To use additional features, select  and then select one of the following options:
  - **share...:** Send a photo to others.
  - **share on SkyDrive:** Upload a photo to the SkyDrive storage. This option may be labelled differently depending on your account settings.
  - **use as wallpaper:** Set a photo as the wallpaper for the lock screen.

- **delete:** Delete a photo.
- **add to favourites:** Add a photo to your favourites.
- **auto-fix:** Adjust the image automatically.

## › Customise camera settings

Before capturing a photo, select  to access the following options:

Option	Function
Save settings	Save the current settings.
Restore default settings	Reset camera settings to their factory default values.
AF mode	Activate Macro mode to take close-up photos or set the camera to focus on the subject.
White balance	Adjust the colour balance according to lighting conditions.
Image effect	Apply a special effect.
Contrast	Adjust the contrast.
Saturation	Adjust the saturation.
Sharpness	Adjust the sharpness.
EV	Adjust the exposure value.
ISO	Adjust the sensitivity of the camera imaging sensor.
Metering	Select a type of exposure metre.
Photo quality	Set the quality level for your photos.
Photo resolution	Change the resolution option.

## › Record a video

- 1 Press the Camera key to turn on the camera.
- 2 Select  to switch to the camcorder.
- 3 Rotate the device to landscape view.
- 4 Aim the lens at the subject and make any necessary adjustments.



Number	Function
1	View the last photo or video you captured or recorded. This icon is available only when you record a video.
2	Switch to the camera.
3	Switch between the front and rear camera lenses.
4	Zoom in or out.  The zoom function may be unavailable when recording in the highest resolution.
5	Change the camcorder settings.



- 5 Select  → a flash option (, ).

6 Press the Camera key to start recording.

7 Press the Camera key to stop recording.

The video is saved automatically.

After recording videos, select  to view the recorded videos.

- To view more videos, scroll left or right.
- To play a video, select .
- To use additional features, select  and then select one of the following options:
  - **share...**: Send a video to others.
  - **delete**: Delete a video.

## ► Customise camcorder settings

Before recording a video, select  to access the following options:

Option	Function
Save settings	Save the current settings.
Restore default settings	Reset camcorder settings to their factory default values.
White balance	Adjust the colour balance according to lighting conditions.
Image effect	Apply a special effect.
Contrast	Adjust the contrast.
Saturation	Adjust the saturation.
Sharpness	Adjust the sharpness.
EV	Adjust the exposure value.
Video quality	Set the quality level for your videos.

## Photo Studio

You can take photos in a variety of shooting modes. You can also edit photos and upload photos to community services to share with others.

### › Capture a photo in Lomo shot mode

You can capture photos with vignetting effects.

- 1 In Menu mode, select **Photo Studio** → **mode** → **Lomoshot**.
- 2 Rotate the device to landscape view.
- 3 Select an effect.
- 4 Make any necessary adjustments.
- 5 Press the Camera key to take a photo.

### › Capture a beauty photo

You can hide facial imperfections using Beauty mode.

- 1 In Menu mode, select **Photo Studio** → **mode** → **Beautyshot**.
- 2 Rotate the device to landscape view.
- 3 Make any necessary adjustments.
- 4 Press the Camera key to take a photo.

## › Capture a combined photo

You can take two photos with the same background and then combine the left and right halves of each photo into one photo. This feature is helpful when you want to take a photo with a friend but there is no one available to take the photo for you.

- 1 In Menu mode, select **Photo Studio** → **mode** → **Plusme**.
- 2 Rotate the device to landscape view.
- 3 Make any necessary adjustments.
- 4 Tap the left or right side you want to take the first photo.
- 5 Press the Camera key to take the first photo.
- 6 Make any necessary adjustments for the second photo.
- 7 Press the Camera key to take the second photo.  
The device will automatically combine the half of the first photo and the other half of the second photo into one photo.

## › Capture a photo with decorative frames

- 1 In Menu mode, select **Photo Studio** → **mode** → **Dreamshot**.
- 2 Rotate the device to landscape view.
- 3 Select a frame.
- 4 Make any necessary adjustments.
- 5 Press the Camera key to take a photo.





## › Capture a panoramic photo



- 1 In Menu mode, select **Photo Studio** → **mode** → **Panamashot**.
- 2 Rotate the device to landscape view.
- 3 Make any necessary adjustments.
- 4 Press the Camera key to take the first photo.
- 5 Slowly move the device in any direction and align the theme colour frame with the viewfinder.  
When you have aligned the frame and viewfinder, the camera will automatically take the next photo.
- 6 Repeat step 5 to complete the panoramic photo.

## › Edit photos

You can edit photos by adjusting, rotating, or cropping.

- 1 In Menu mode, select **Photo Studio** → **edit**.
- 2 Select an image.
- 3 Use the following options to edit the photo:

Icon	Function
	Adjust the photo automatically.
	Adjust the brightness of the photo.
	Adjust the colour balance.
	Rotate or flip the photo.
	Crop the image by moving or dragging the rectangle.

- 4 Adjust the image as desired and select .
- 5 When you are finished, select  → **ok**.

## › Upload photos to the web





- 1 In Menu mode, select **Photo Studio** → **share**.
- 2 Select a web service.
- 3 Select **Connect** (if necessary).
- 4 Enter your user name and password and sign in.
- 5 Follow the on-screen instructions to upload photos.

## FunShot

You can take photos with various effects.

### › Take a photo with a FunShot effect



- 1 In Menu mode, select **FunShot**.
- 2 Tap the screen to hide the help screen.
- 3 Change the shooting mode by selecting one of the following icons:

Icon	Function
	Take a single shot.
	Take multiple shots. To change the frame layout, select  .
	Take photos of yourself with the front camera.



- 4 Select an effect.
- 5 To select whether or not to add a delay before the camera takes a photo, select **On** or **Off**.
- 6 Select **Start** to start the timer, or select **Shot** to take a photo.
- 7 Select **Save**.

## › View a photo

- 1 In Menu mode, select **FunShot** → .
  - 2 Scroll left or right to view more photos.
-  To upload a photo to your community website, select .

## Pictures

Learn to view photos with your device.

-  • Some file formats are not supported depending on the software of the device.
- If the file size exceeds the available memory, an error can occur when you open files.
  - Playback quality may vary by content type.
  - Some files may not play properly depending on how they are encoded.

- 1 In Menu mode, select **Pictures**.
- 2 Select a category → a photo (with no icon).

While viewing photos, use the following options:

- To view more photos, scroll left or right.
- To zoom in, place two fingers on the screen and spread them apart. To zoom out, move your fingers closer together. You can also double-tap the screen.
- To use additional features, select  and then select one of the following options:
  - **share...:** Send a photo to others.
  - **share on SkyDrive:** Upload a photo to the SkyDrive storage. This option may be labelled differently depending on your account settings.
  - **use as wallpaper:** Set a photo as wallpaper for the lock screen.
  - **delete:** Delete a photo.
  - **add to favourites:** Add a photo to your favourites.
  - **auto-fix:** Adjust the image automatically.

## Music+Videos

Learn to use the music player, the video player, and the FM radio.

### › Supported file formats

Your device supports the following file formats:

Type	Format
Music	m4a, m4b, wma, mp3
Video	m4v, mp4, avi, mov, dvr-ms, wmv



- Some file formats are not supported depending on the software of the device.
- If the file size exceeds the available memory, an error can occur when you open files.
- Playback quality may vary by content type.
- Some files may not play properly depending on how they are encoded.

## › Add files to your device

You can synchronise Zune on your PC to add files to your device.

- 1 Using a USB cable, connect the multifunction jack on your device to a PC with Zune installed.  
When connected, Zune will automatically run on the PC.
- 2 Customise the sync settings and set your device's name by following the on-screen instructions.
- 3 From the Zune screen, access your collection list.
- 4 Select and drag the files you want to the device icon at the bottom left of the screen.





To disconnect the device from the PC, click the USB device icon on the Windows task bar and click the option to safely remove the device. Then remove the USB cable from the PC. Otherwise, you may lose data stored on your device.

## › Play music

- 1 In Menu mode, select **Music+Videos** → **zune** → **music**.
- 2 Scroll left or right to a music category.
- 3 Select a music file.

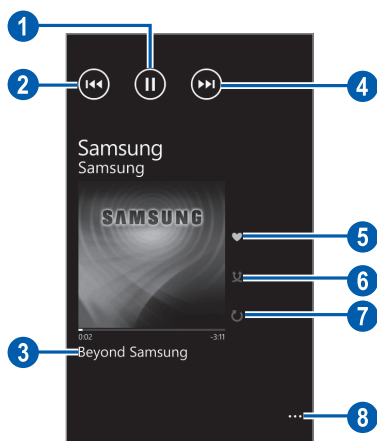
#### 4 Control playback with the following keys:





Number	Function
1	Pause playback; Select  to resume playback.
2	Move to the previous file; Scan backward in a file (tap and hold).
3	Access the playlist.
4	Move to the next file; Scan forward in a file (tap and hold).
5	Rate the current track.
6	Activate Shuffle mode.
7	Change the repeat mode.
8	Access a list of other options.



You can control the music player with a headset. From the Start screen, press and hold the headset button to launch the music player. Press the headset button to start or pause playback.

While playing music, use the following options:

- To create a new playlist by sorting music files based on artist or genre, select  → **play smart dj mix**.
- To share the music information by sending a message, select  → **share**.
- To save the current playlist, select  → **save as playlist**.

## ▶ Play a video

- 1 In Menu mode, select **Music+Videos** → **zune** → **videos**.
- 2 Scroll left or right to a video category.
- 3 Select a video to play.
- 4 Rotate the device to landscape view.
- 5 Control playback with the following keys:

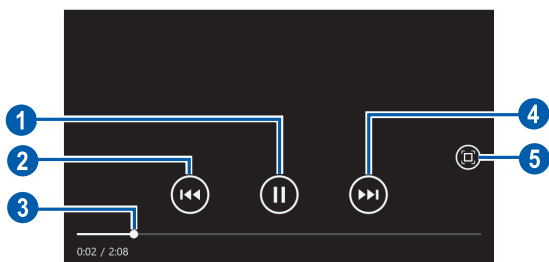

Number	Function
1	Pause playback; Select  to resume playback.
2	Restart playback; Scan backward in a file (tap and hold).
3	Scan forwards or backwards in the file by dragging or tapping the bar.
4	Scan forward in a file (tap and hold).
5	View the video on the full screen.

## › Play a podcast

- 1 In Menu mode, select **Music+Videos** → **zune** → **podcasts**.
- 2 Scroll left or right to a podcast category.
- 3 Select a podcast → an episode → .

## › Listen to the FM radio

Learn to listen to music and news on the FM radio. To listen to the FM radio, you must connect a headset, which serves as the radio antenna.

- 1 Plug a headset into the device.
- 2 In Menu mode, select **Music+Videos** → **zune** → **radio**.
- 3 Control the FM radio with the following keys:

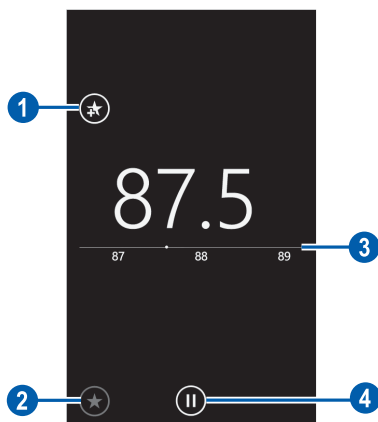

Number	Function
1	Add the current radio station to the favourites list; Select  to remove the radio station from the favourites list.
2	Access the favourites list.

Number	Function
3	Fine-tune the frequency.
4	Turn off the FM radio; Select  to turn on the FM radio.

Tap and hold the empty area below the radio frequency and use the following options:

- **pin to start:** Add the current radio station to the Start screen.
- **settings:** Select a region for searching for FM radio stations and updating frequencies.
- **switch to speaker/switch to headset:** Change the sound output to the headset or device's speaker.





## › Use the mini player

When you exit after playing music or listening to the FM radio, playback continues in the background. You can control the playback by using the mini player.

1 While music or FM radio is playing in the background, press the Volume key.

The mini player appears at the top of the screen.

2 Control playback with the following keys:

Key	Function
	Move to the previous file or radio station.
	Pause playback or turn off the FM radio; Select  to resume playback or turn on the FM radio.
	Move to the next file or radio station.
Volume	Adjust the volume.

## Games

Learn to play games and download new games from the Xbox LIVE website.



The download of games may not be supported depending on the software of the device.

### › Play games

1 In Menu mode, select **Games** → a game.

2 Follow the directions on the screen to play the game.



- Available games may vary depending on your region or service provider.

- Controls and options of games may vary.

### › Download games

1 In Menu mode, select **Games** → **get more games**.

2 Scroll left or right to access other games.

3 Search for a game or application and download it to the device.





# Personal information

## People



Learn to create and manage a list of your personal or business contacts stored on the device's memory or a SIM or USIM card. You can save names, phone numbers, email addresses, and more for your contacts.

You can also share news with other people by setting up web accounts.

### › Create a contact

- 1 In Menu mode, select **People** → **all** →  → **new contact**.
- 2 Select a memory location.  
If you have more than one account, select an account to which you want to add the contact.
- 3 Enter contact information.
- 4 Select  to add the contact to memory.





You can also create a contact from the dialling screen.

- 1 In Menu mode, select **Phone** →  and enter a phone number.
- 2 Select **save** → .
- 3 Select a memory location.  
If you have more than one account, select an account to which you want to add the contact.
- 4 Enter contact information.
- 5 Select  to add the contact to memory.

## › Find a contact



- 1 In Menu mode, select **People** → **all**.
- 2 Scroll up or down on the contact list.  
You can also select  and enter a name.
- 3 Select a contact's name.

From the contact view, use the following options:

- To call the contact, select a phone number.
- To send a message, select **text**.
- To send an email, select **send email**.
- To add the contact to the Start screen, select .
- To link the contact to other contacts, select .
- To edit the contact information, select .
- To delete the contact, select  → **delete**.

## › Create a group of contacts

By creating groups of contacts, you can manage multiple contacts and send messages to an entire group.

- 1 In Menu mode, select **People** → **all** →  → **new group**.
- 2 Enter a name for the group.
- 3 Select **add a contact** → a contact to add to the group.  
Repeat this step to add more contacts.
- 4 Select .

## › Import contacts from a SIM or USIM card

You can import contacts from a SIM or USIM card without saving the contacts manually.

- 1 Insert a SIM or USIM card that contains contacts into your device, and then turn on your device.

2 In Menu mode, select **People** → **all** →  → **settings**.

3 Select **import SIM contacts**.

4 Select contacts to import, and then select **import**.



You can also import contacts from another phone to your device via Bluetooth. ► p. 90

## › View posts from social network sites

You can view the latest posts and photos from Facebook, Twitter, or other social network sites, and comment on them.

### Set up a social network account

1 In Menu mode, select **People** → **all** →  → **settings** → **add an account** → a social network service.

2 Follow the on-screen instructions to set up an account.



- When you are finished setting up the social network account, the shortcut to the account is added to the Start screen.
- If you have set up a Windows Live account, your Windows Live profile appears on the top of the contact list, select the profile to set the quick message for sharing with others or refresh news.
- If you have set up a Facebook account, your Facebook friends appears in the People hub, the Pictures hub, and the Me card.

### View new posts from your friends

1 In Menu mode, select **People** → **what's new**.



2 Select  → **refresh** to update the post list.

3 Select a post.



# Calendar

Learn to create and manage daily or monthly events or tasks, and set alarms to remind yourself of important events or tasks.





## › Create an event

- 1 In Menu mode, select **Calendar** → **day** or **agenda** → .
- 2 Enter the details of the event as required.
- 3 Select .

## › Create a task

- 1 In Menu mode, select **Calendar** → **to-do** → .
- 2 Enter the details of the task.
- 3 Select .

## › View events or tasks

- 1 In Menu mode, select **Calendar** → **day** or **agenda**.
  - 2 Select  to view the calendar in the month view.  
To move to a specific month, scroll up or down the screen or tap the month at the top of the calendar.
  - 3 Select a date.
  - 4 Select an event or task to view its details.
-  • To set events to be indicated by calendar type, select  → **settings** and set the colours for each calendar.
  - For a task, you can set it as completed by selecting .

## › Stop an event or task alarm

If you set an alarm for a calendar event or task, the alarm will sound at the specified time. When the alarm sounds,

- Select **dismiss** to stop the alarm.
- Select **snooze** to silence the alarm for the snooze period.

# Web

Web services require a data connection. Contact your operator to choose the best data plan.

## Internet Explorer

Learn to access and bookmark your favourite web pages.



- You may incur additional charges for accessing the web and downloading media files. For details, contact your service provider.
- Available icons may vary depending on your region or service provider.

## › Browse web pages

1 In Menu mode, select **Internet Explorer** to launch a specified homepage.

To access a specific web page, select the URL input field, enter the web address (URL) of the web page, and select →.

2 If you are launching this application for the first time, set whether or not to use your location, and then whether or not to collect the search history.

### 3 Navigate web pages with the following keys:





Number	Function
1	Enter the web address of a web page to access.
2	Reload the current web page.
3	Access more options.

While browsing the web page, use the following options:

- To zoom in or out, place two fingers on the screen and spread them apart (move your fingers closer together to zoom out).
- To view the currently active windows, select → **tabs**. You can open multiple pages and switch back and forth between them.
- To view the recent history, select → **recent**.
- To open a list of saved bookmarks, select → **favourites**.
- To bookmark the current web page, select → **add to favourites**.
- To send the web address (URL) of the web page to others, select → **share page**.
- To add a shortcut to the current page to the Start screen, select → **pin to start**.
- To customise the browser settings, select → **settings**.

## › Bookmark your favourite web pages



- 1 In Menu mode, select **Internet Explorer**.
- 2 Select  → **add to favourites**.
- 3 Enter a page title and a web address (URL).
- 4 Select .

To view bookmarks, select  → **favourites**. From the bookmark list, tap and hold a bookmark and use the following options:

- To edit the title and web address, select **edit**.
- To delete the bookmark, select **delete**.

## › Access the recent history

- 1 In Menu mode, select **Internet Explorer**.
- 2 Select  → **recent**.
- 3 Select a web page to access.

 To clear the history, select .







## Maps

Learn to use the map to find your location, search for streets, cities, or countries, and get directions.







 This feature may be unavailable depending on your region or service provider.







## > Search for a specific location



- 1 In Menu mode, select **Maps**.  
The map will display your current location.
- 2 If you are launching this application for the first time, set whether or not to use your location.
- 3 Select , enter a keyword for the location, and select .  
To search for a location by voice, select .
- 4 Tap and hold on a location to view the address. A mark that shows the address appears.  
To zoom in, place two fingers on the screen and spread them apart. To zoom out, move your fingers closer together. You can also double-tap the screen.
- 5 Select the mark to view the full address and information about nearby locations or businesses.
  - To add the location view to the Start screen, select .
  - To share the location information with others, select .
  - To add the location as a favourite place, select .

While viewing the map, you can use the following options:

- To search for a place around you, select .
- To get directions to a specific destination, select .
- To view my location, select .
- To view a list of ways to get to a location, select  → **directions list**.
- To view a list of all results for your search, select  → **search results**.
- To clear all information for your search on the map, select  → **clear map**.

- To view a list of your favourite places, select  → **favourite places**.
- To hide or show marks for favourite places on the map, select  → **hide favourites** or **show favourites**.
- To view the map in aerial view, select  → **aerial view on**.
- To customise the settings for the map, select  → **settings**.

## › Get directions to a specific destination

- 1 In Menu mode, select **Maps** → .
- 2 Enter the addresses of the starting location and the ending location and then select .
- 3 Select a travel route to view details of your trip.
- 4 When you are finished, select  → **clear map**.

## Marketplace

Marketplace allows you to find and add new applications, games, and music files to your device. With Marketplace, you can search, browse, preview, buy, and download new applications, games, and music files directly to your device.

- 1 In Menu mode, select **Marketplace**.
- 2 Select a category.
- 3 Search for and download applications, games, or music files.

# Now

Learn to get information services for the current day, such as weather forecasts, stock information, or news.



This feature may be unavailable depending on your region or service provider.

## › Customise Now settings

- 1 In Menu mode, select **Now**.
- 2 If you are launching this application for the first time, set whether or not to use your location.
- 3 Scroll left or right to a service.



You can add Now services by selecting **settings** → **sections**.

- 4 Select .
- 5 Adjust the following settings for each service:
  - weather

Option	Function
Add a city	Add cities for the weather forecasts.
Auto refresh when application starts	Set the screens to be automatically updated with the latest information.
Auto Location	Set to display the weather information for your current location.
Weather Animation	Set to display the weather information with an animation.

Option	Function
Temperature Unit	Select a temperature unit.
System of Measurement	Select a measurement system.

- news

Option	Function
Add a category	Select a news category.
Auto refresh when application starts	Set the screens to be automatically updated with the latest information.
edition	Set the regional edition to be updated.
front page	Select a news topic to display on the main screen.
SNS connection	Select a community service for uploading news information.

- stocks

Option	Function
Add a stock	Add stocks to monitor.
Add an index	Add an index for stocks to monitor.
Auto refresh when application starts	Set the screens to be automatically updated with the latest information.
Display stocks by	Set how to display stock information.
Display order	Change the display order for indexes and stocks.

- currency

Option	Function
Auto refresh when application starts	Set the screens to be automatically updated with the latest information.
Base currency	Set a base currency to use for the exchange rate.
Add currency	Add currencies to monitor.

- top tweets

Option	Function
Add a country	Add countries to view Twitter posts.
Auto refresh when application starts	Set the screens to be automatically updated with the latest information.
front page	Set a country option for Twitter posts that will appear on the main screen.
SNS connection	Select a community service for uploading Twitter posts.

## › View Now information

- 1 In Menu mode, select **Now**.
- 2 Scroll left or right to a service.
- 3 Select  to update information.
- 4 Select an item to view details, or scroll up or down to view more information.

# Connectivity

## Bluetooth

Learn to connect your device to Bluetooth-enabled accessories, such as headsets or hands-free car kits. Make sure that the accessory you want to pair with is turned on so that your device can discover it.



- If there are obstacles between the devices, the operating distance may be reduced.
- Some devices, especially those that are not tested or approved by Bluetooth SIG, may be incompatible with your device.
- Do not use the Bluetooth feature for illegal purposes (for example, pirating copies of files or illegally tapping communications for commercial purposes). Samsung is not responsible for the repercussions of illegal use of the Bluetooth feature.

- 1 In Menu mode, select **Settings** → **Bluetooth**.
- 2 Drag the slider next to **Bluetooth** to turn on the Bluetooth feature.  
Your device searches for and displays available Bluetooth-enabled accessories.
- 3 Select a Bluetooth-enabled accessory.
- 4 Select **ok** to match the Bluetooth PIN between two devices.

## WiFi

Learn to use your device's wireless networking capabilities to activate and connect to any wireless local area network (WLAN) compatible with the IEEE 802.11 standards.

You can connect to the internet or other network devices anywhere an access point or wireless hotspot is available.

 Your device uses non-harmonised frequency and is intended for use in all European countries. The WLAN can be operated in the EU without restriction indoors, but cannot be operated outdoors in France.

### ▶ Activate the Wi-Fi feature

- 1 In Menu mode, select **Settings** → **WiFi**.
- 2 Drag the slider next to **WiFi networking** to activate the Wi-Fi feature.

 The Wi-Fi feature running in the background will consume battery power. To preserve battery power, activate the feature only when needed.

### ▶ Find and connect to a Wi-Fi AP

- 1 In Menu mode, select **Settings** → **WiFi**.  
The device will automatically search for available Wi-Fi APs.
- 2 Select a network.
- 3 Enter a password for the network and select **done** (if necessary).

Once your device is connected to a Wi-Fi AP, you can use internet services via Wi-Fi connections.

## AllShare

Learn to use the Digital Living Network Alliance (DLNA) service that enables you to share media files between DLNA-enabled devices in your home over Wi-Fi.



- The supported file formats may vary depending on the software of the device.
- Some files may not play on the DLNA-enabled devices depending on the devices.

### ➤ Customise DLNA settings for sharing media files

To allow other DLNA-enabled devices to access media files on your device, you must activate media sharing.

1 In Menu mode, select **AllShare** → **My collection** → .

2 Adjust the following settings to customise the DLNA feature:

Option	Function
Device name	View a media server name for your device.
Share videos	Turn on video sharing with other DLNA-enabled devices.
Share photos	Turn on image sharing with other DLNA-enabled devices.
Share music	Turn on music sharing with other DLNA-enabled devices.



## ▶ Play your files on another DLNA-enabled device

- 1 In Menu mode, select **AllShare** → **My collection**.
  - 2 Select a media category and a file.
  - 3 Select a player—the one that will play the media file. Playback begins at the selected player.
  - 4 Control playback using icons of your device.
-  Playback may be buffered, depending on the network connection and the connected server.

## ▶ Play files from one device on the other device

- 1 In Menu mode, select **AllShare** → **Remote**.
- 2 Select  to search for DLNA-enabled devices.
- 3 Select a device as the media server—the one that contains media files.
- 4 Select a media category and a file.
- 5 Select a player—the one that will play the media file. Playback begins at the selected player.
- 6 Control playback using icons of your device.

## Mobile network sharing

Learn to set your device as a wireless access point for PCs or other devices, and share your device's mobile network connection.

- 1 In Menu mode, select **Settings** → **system** → **Internet Sharing**.

- 2 Drag the slider next to **Sharing** to activate the WLAN tethering feature.
- 3 From another device, locate your device's name in the available connection list and connect to the network.  
Your device shares the mobile network connection with the other device.

## GPS

Your device is equipped with a global positioning system (GPS) receiver. Learn to activate the GPS feature to allow applications, such as the camera or map, and to access your location information.

To receive better GPS signals, avoid using your device in the following conditions:

- between buildings, in tunnels or underground passages, or inside buildings
- in poor weather
- around high voltage or electromagnetic fields
- in a vehicle with sun protect film

 Do not touch or cover the antenna area with your hands or other objects while using the GPS functions.

 This feature may be unavailable depending on your region or service provider.

### > Activate the GPS feature



- 1 In Menu mode, select **Settings** → **location**.
- 2 Drag the slider next to **Location services** to activate the GPS feature.

# Tools

## Alarms

Learn to set and control alarms for important events.

### › Set a new alarm

- 1 In Menu mode, select **Alarms**.
- 2 Select .
- 3 Set alarm details.
- 4 When you are finished, select .

### › Stop an alarm

When the alarm sounds,

- Select **dismiss** to stop the alarm.
- Select **snooze** to silence the alarm for the snooze period.

### › Deactivate an alarm

- 1 In Menu mode, select **Alarms**.
- 2 Drag an alarm slider to the left.

## Calculator

Learn to perform mathematical calculations directly on your device like a typical hand-held or desktop calculator.



- 1 In Menu mode, select **Calculator**.
  - 2 Use the keys that correspond to the calculator display to perform basic mathematical operations.
-  Rotate the device to landscape view to use the scientific calculator.

## MiniDiary

Learn to keep a photo diary.

-  The feature may be unavailable depending on your region or service provider.

### › Create a Mini diary

- 1 In Menu mode, select **MiniDiary**.
- 2 If you are launching this application for the first time, set whether or not to use your location.
- 3 Select **new** to create a new entry.  
If there is a diary saved, select .
- 4 Change the today's date and set the weather (if necessary).
- 5 Select the photo field and add an image or capture a photo.  
To add the location information from the attached photo, select **location**. To select the location on the map, select .

6 Select the text field to enter text, and select .

7 Select  → **save**.

## › View a Mini diary

1 In Menu mode, select **MiniDiary**.

2 Scroll left or right to a category and select a diary.



To upload a mini diary to your community website or send it others, select .

## Office





Learn to create and edit Excel workbooks and Word documents, open and view PowerPoint slideshows, create notes, or search for and share document files with others.



## › Create and edit a note with OneNote Mobile

1 In Menu mode, select **Office** → **notes**.













2 Select  to create a new note.

3 Enter a title and text.









- To change the sentence to a bulleted list, select .
- To add a tick box and create a to-do list, select .
- To change the sentence to a numbered list, select  → **numbered list**.
- To indent the sentence, select  → **increase indent** or **decrease indent**.
- To change the text format, select  → **format**.

- 4 To add an image, select .
- 5 To record a sound clip, select .
- 6 When you are finished, press [].

## ► Create and edit an Excel workbook





- 1 In Menu mode, select **Office** → **documents**.
- 2 Select  → **Excel** or select a template under **templates**.  
To view and edit a workbook, select an Excel file from the file list.
- 3 Select a cell and enter values or text.
  - To move to another worksheet, select  → a worksheet.
  - To add a comment to a cell, select .
  - To find data in the workbook, select .
  - To use functions, select .
  - To sort the cells, select  → **sort...**
  - To apply a filter to cells, select  → **apply filter**.
  - To change the cell and text format, select  → **format cell...**
  - To undo or redo your last action, select  → **undo** or **redo**.
  - To send the file to others, select  → **share...**
  - To zoom in or out, double-tap the screen.
  - To access files via SkyDrive, a Microsoft SharePoint 2010 website, or a SharePoint Online website, select  → **open location**.
- 4 When you are finished, select  → **save**.
- 5 Enter a name for the document, select a memory location, and then select **save**.

## › Create and edit a Word document

- 1 In Menu mode, select **Office** → **documents**.
- 2 Select  → **Word** or select a template under **templates**.  
To view and edit a document, select a Word file from the file list.
- 3 Create or edit your document.
  - To move to another paragraph, select  → a paragraph.
  - To add a comment to text, highlight the text and select .
  - To search for text in the document, select .
  - To change the text format and colour, select .
  - To edit the document, select . This option is available only when you save a document.
  - To send the file to others, select  → **share...**
  - To access files via SkyDrive, a Microsoft SharePoint 2010 website, or a SharePoint Online website, select  → **open location**.
  - To zoom in or out, place your two fingers on the screen and slowly spread apart or pinch.
- 4 When you are finished, select  → **save**.
- 5 Enter a name for the document, select a memory location, and then select **save**.

## › View and edit a PowerPoint presentation

- 1 In Menu mode, select **Office** → **documents**.
- 2 Select a PowerPoint file.
- 3 Rotate the device to landscape view.
- 4 Select  to switch to Edit mode.





- 5 Edit your document.
  - To edit the text, select .
  - To move the cursor to the next paragraph, select .
  - To add a note to a slide, select .
  - To change the order of slides, select  → **move slide**.
  - To hide or display the current slide, select  → **hide slide** or **unhide slide**.

6 When you are finished, select .

7 Select  → **save**.

8 Enter a name for the document and then select **save**.

While viewing the edited document, use the following options:

- To zoom in or out, place your two fingers on the screen and slowly spread apart or pinch.
- To advance the slides, scroll left or right.
- To add a note to a slide, select .
- To move to another slide, select  → a slide.
- To view the custom show, select  → **custom show**.
- To send the document to others, select  → **share...**
- To access files via SkyDrive, a Microsoft SharePoint 2010 website, or a SharePoint Online website, select  → **open location**.

## ► Manage documents online

1 In Menu mode, select **Office** → **locations** → a service.

2 Follow the on-screen instructions to set up an account or sign in to a service.

3 View and manage your documents on the server as desired.







## Search

You can search for information on the internet with Bing.



This feature may be unavailable depending on your region or service provider.

- 1 Press [O].  
The Bing search screen opens.
- 2 If you are launching this application for the first time, set whether or not to use your location.
- 3 Select the keyword field, enter a keyword, and select →.
  - To search for a nearby location, select .
  - To find music information, select .
  - To read and recognise a Quick Response (QR) code, select .
  - To search for data by voice, select .
- 4 Scroll left or right to change the results category.
- 5 Select an item.

## Voice command

Learn to dial a number, open an application, or send a message by voice.



- This feature may be unavailable depending on your region or service provider.
- Recognised languages may vary depending on your region or service provider.

- 1 Press and hold [].



If you are launching this application for the first time, select **accept**.

- 2 Say a command into the microphone.
- Say “Call” and then a name or a phone number. The device dials the selected number.
  - Say “Open” and then an application. The device opens the corresponding application.
  - Say “Text” and then a name. The device opens the message composer screen.

## Wireless Manager

Learn to manage your device’s status and settings related to the wireless network features.

### › call

Change the options for the calling feature.

Option	Function
call forwarding	Divert incoming calls to another number. ▶ p. 33
call waiting	Activate call waiting to receive an incoming call when you are already on a call. ▶ p. 34

### › apn

Change the options for the APN (access point name) for web connections.

Option	Function
Automatic APN	Set the device to automatically set up an access point name when you insert a SIM card.
Active APN	Select an APN to use from the APN list.
Edit APN	Set up or edit access point names.

# Settings

## Access the Settings menu

- 1 In Menu mode, select **Settings**.
- 2 Scroll left or right to a setting category and select an option.
- 3 Customise the setting.

## system

Change the settings for your device's system.

### › ringtones+sounds

- **Ringer:** Activate Silent mode to mute all sounds, except media sounds and alarm ringtones.
- **Vibrate:** Set the device to vibrate for various events.
- **Ringtone:** Select a ringtone to use if you set the device to alert you to incoming calls by playing a melody.
- **New text or IM:** Select a ringtone to use if you set the device to alert you to incoming messages by playing a melody.
- **New voicemail:** Select a ringtone to use if you set the device to alert you to incoming voice mail messages by playing a melody.
- **New email:** Select a ringtone to use if you set the device to alert you to incoming email messages by playing a melody.
- **Play a sound for:** Activate or deactivate sounds for various events on the device.

## › theme

- **Background:** Select a colour for the background.
- **Accent colour:** Select a colour for the highlight.

## › flight mode

Activate Flight mode to disable wireless features, such as mobile networks, Wi-Fi, Bluetooth, and the FM radio. In Flight mode, you can activate network services individually, except for your device's mobile network.

## › WiFi

- **WiFi networking:** Turn the Wi-Fi feature on or off. ► p. 71
- **Notify me when new networks are found:** Set the device to notify you when an open network is available.
- **advanced:** Add Wi-Fi APs manually.

## › Bluetooth

Turn the Bluetooth feature on or off. ► p. 70

## › Internet Sharing

Activate the Wi-Fi tethering feature to share your device's mobile network connection with PCs or other devices through the Wi-Fi feature.

## › email+accounts

View, set up, or edit email accounts.

## › lock+wallpaper

- **change wallpaper:** Change the background image for the lock screen.
- **Show artist when playing music:** Set to show the artist's name when playing music from the Start screen.
- **Screen times out after:** Set the length of period the device waits before locking the touch screen.
- **Password:** Activate or deactivate the device lock feature to require a device password before using the device. To activate the device lock feature, you must create a password.
- **change password:** Change the device password. This option is available only when you activate the device lock feature.
- **Require a password after:** Set the length of time the device waits before locking itself. This option is available only when you activate the device lock feature.

## › location

Activate the GPS feature for finding locations.

## › mobile network

- **Active network:** View the network that you are currently using.
- **Data connection:** Activate or deactivate the data connection feature.
- **Data roaming options:** Set the device to connect to another network when you are roaming or your home network is not available.

- **Highest connection speed:** Select a connection speed for connecting to your mobile network.
- **Network selection:** Set the network selection method to automatic or manual.
- **add apn:** Set up an access point name.

## › battery saver

- **Always turn on Battery Saver when battery is low:** Automatically activate Power saving mode when the battery is low. In Power saving mode, your device will stop some applications or services to reduce battery consumption.
- **Turn on Battery Saver now, until the next charge:** Activate Power saving mode until the battery is charged.
- **battery information:** View the remaining battery life.

## › date+time



If the battery remains fully discharged or removed from the device, the time and date will be reset.

- **24-hour clock:** Set to the time to be displayed in 24-hour format.
- **Set automatically:** Automatically update the time when you move across time zones. Deactivate this feature to set your time zone, time, and date manually.



This feature may be unavailable depending on your region or service provider.

- **Time zone:** Select your home time zone.
- **Date:** Set the current date manually.
- **Time:** Set the current time manually.

## › brightness

- **Automatically adjust:** Set your device to automatically adjust the brightness of the display according to light conditions.



Allowing the device to overheat may reduce the maximum brightness of the screen.

- **Level:** Set the brightness of the display. This option is available only when you deactivate the automatic adjustment feature.

## › keyboard

Select input languages to use with the keyboard. To change the keyboard settings, select **typing settings**. Some options may be unavailable depending on the selected language.

### • **Keyboard:**

- **Suggest text and highlight misspelt words:** Set the device to predict words according to your input and display word suggestions.
- **Correct misspelt words:** Set the device to automatically correct misspelt words.
- **Insert a space after selecting a suggestion:** Set the device to automatically insert a space after you select a word from the suggestion list.
- **Insert a full-stop after double-clicking the SPACEBAR:** Set the device to automatically insert a full stop when you double-tap the virtual spacebar.
- **Capitalise the first letter of a sentence:** Set the device to automatically capitalise the first letter after a final punctuation mark, such as a full stop, question mark, or exclamation mark.

- **Send keyboard touch information to improve typing and more:** Set to send feedback about your keyboard usage to Microsoft.
- **reset suggestions:** Delete all words that you added to the suggestion list.

## › region+language

- **Display language:** Select a display language for all menus and applications.
- **Region format:** Select a region for a display format. This setting affects the time and date format or units.
- **Short date (sample):** Select a short format for displaying dates.
- **Long date (sample):** Select a long format for displaying dates.
- **First day of week:** Set which day should begin the week.
- **System locale:** Select a language for the system locale. This setting determines the default character set and font that are used to display information in applications that do not support Unicode.
- **Browser & search language:** Select a language to use when web browsing and searching.

## › speech

- **Enable speech recognition over the network:** Activate the voice input feature to enter message text or search keyword by voice. Your voice data will be sent to Microsoft to improve the service.
- **Use Speech when the phone is locked:** Activate the voice command feature even if the device is locked.
- **Play audio confirmations:** Set to provide an audible confirmation of your voice commands.



- **Read incoming text messages aloud:** Set the condition for activating the text-to-speech feature when you have an incoming message.

## › find my phone

Find and manage your lost device from the web. You can set ringtones, lock the device, or delete data from the device at the Windows Live website. To use this feature, you must sign in to your Windows Live account.

## › phone update

- **Notify me when new updates are found:** Set the device to notify you when new updates are available.
- **Use my mobile data connection to check for updates:** Set the device to use your mobile network to check for new updates.

## › about

View your device information. You can also use the following options:

- **more information:** View more information about your device.
- **reset your phone:** Reset your device to the factory default values.

## › feedback

Set your device to send feedback about how you use Windows mobile products. This helps Microsoft identify trends and usage patterns to improve future versions of products.

## › extra settings

**Use auto display intensity:** Set to save power by automatically adjusting the brightness of the display when the background is set to white.

## › contact import

Import contacts from another phone to your device via Bluetooth.

## › call blocking

Set to reject calls from specified phone numbers automatically. You can add phone numbers to the reject list.

▶ p. 33

## › advanced text messages

- **Enable CB message reception:** Enable or disable cell broadcast message reception.
  - **CB languages:** Select languages for a broadcast message.
  - **Set channel list manually:** Add or edit the channel list for a broadcast message.
- **Use unicode when necessary:** Set to use unicode characters for a broadcast message.

## › SIM applications

View and access a variety of additional services offered by your service provider. Depending on your SIM or USIM card, this menu may be available but labelled differently.

## applications

Change the settings for your device's applications.

### › background tasks

View a list of applications that are running in the background when using other applications.

### › games

- **Connect with Xbox LIVE:** Set to connect the Xbox LIVE website to download new games.
- **Synchronise game requests:** Set to pair with other devices automatically for playing Xbox LIVE multiplayer games.
- **Show game alerts:** Set to display alerts when you receive Xbox LIVE notifications.

### › Internet Explorer

- **Allow access to my location:** Set to allow Internet Explorer to use your location information.
- **Allow cookies on my phone:** Set the device to save cookies that are pieces of personal information sent to a web server while you were navigating the web.
- **Get suggestions from Bing as I type:** Set the device to show results as soon as you enter a keyword.
- **Allow Internet Explorer to collect my browsing history:** Set to allow Internet Explorer to collect data about your web browsing history.

- **Website preference:** Select a display mode for the browser.
- **Open links from other applications in:** Set whether to open a new window or use the current window when you select a link from other applications.
- **delete history:** Clear the history, data, and files that have been saved while you were navigating the web.

## › maps



This feature may be unavailable depending on your region or service provider.

- **Change map orientation for driving directions:** Set whether or not to reorient the map when you rotate your device.
- **Use my location:** Set the device to use your location information for better search results.
- **delete history:** Clear the history and data that have been saved while you were searching for locations.

## › messaging

- **SMS delivery confirmation:** Send a request for a delivery report along with your message to be informed when your messages are delivered.
- **Group text:** Set to keep replies in one thread while you are texting to a group of people. Your replies will be sent as multimedia messages.
- **MMS delivery confirmation:** Set the network to inform you when your multimedia messages are delivered.
- **Send MMS acknowledgement:** Set the network to inform senders when you receive their multimedia messages.
- **SMS centre number:** Enter the centre address for text messages.

## › music+videos

- **Connect with Zune:** Set to connect to the Zune website when you launch the music player.
- **Zune Account Settings:** Customise the settings for your Zune account.

## › Office

- **User name:** Enter a user name to identify yourself on memos in documents.
- **Open SharePoint links in the Office hub:** Set to open and share SharePoint links with others in the Office hub.
- **UAG server:** Set up the Unified Access Gateway (UAG) server for secured connections.
- **Reset Office:** Reset Office to the factory default values.
- **About:** View version information of your Microsoft Office 2011 applications.

## › people

- **import SIM contacts:** Import contacts from the SIM or USIM card to the device.
- **filter my contact list:** Select a filter for contacts displayed in the phonebook.
- **Only show posts from people visible in my contact list:** Set to show social media posts only from the contacts that are visible in your phonebook.
- **Sort list by:** Set how to sort the contact list.
- **Display names by:** Set how to display contact names.
- **Use my location:** Set the device to use your location information for better search results.
- **Save check-in history with my Windows Live ID to improve search results:** Set to save the check-in history for to your Windows Live account.
- **accounts:** Set up, sync, or delete web accounts.

## › phone

- **Voicemail number:** Enter the centre address for voice mail messages.
- **Show my caller ID to:** Show your mobile phone number to the other party.
- **Call forwarding:** Divert incoming calls to another number.
- **International assist:** Activate or deactivate international assistance to automatically correct some common mistakes in international calls or calls while you are roaming.
- **SIM security:** Activate or deactivate the PIN lock feature to require the PIN before using the device.
- **change SIM PIN:** Change the PIN used to access SIM or USIM data. This option is available when the PIN lock feature is activated.

## › pictures+camera

- **Press the screen to take pictures:** Set to tap the touch screen to take a photo.
- **Press and hold camera button to wake up the phone:** Set to turn on the touch screen by pressing the Camera key.
- **Prevent accidental camera launch when phone is locked:** Set not to launch the camera by pressing the Camera key when the device is locked.
- **Include location information in pictures you take:** Set the camera to include location information for your photos.
- **Keep location information on uploaded pictures:** Set the camera to upload captured photos and videos with location information.
- **Automatically upload to SkyDrive:** Set the camera to automatically upload captured photos and videos to the SkyDrive storage.

- **Quick Share Account:** Select an account for uploading photos. Depending on this setting, the sharing shortcut options may be labelled differently.
- **reset camera:** Reset camera and camcorder settings.

## › radio

**Region:** Select a region for searching for FM radio stations and updating frequencies.

## › search



This feature may be unavailable depending on your region or service provider.

- **Use my location:** Set the device to use your location information for better search results.
- **Send location information for Microsoft Tags:** Set to include your location information for use with Microsoft Tag applications.
- **Allow search button from lock screen:** Set to use [🔍] even if the device is locked.
- **Get suggestions from Bing as I type:** Set the device to suggest results as soon as you enter a keyword.
- **Allow Microsoft to store and use images from vision searches:** Set to allow Microsoft to save and use images from your device's camera when you perform Bing Vision searches.
- **delete history:** Clear your search history.

# Troubleshooting

When you turn on your device or while you are using the device, it prompts you to enter one of the following codes:

Code	Try this to solve the problem:
Password	When the device lock feature is enabled, you must enter the password you set for the device.
PIN	When using the device for the first time or when the PIN requirement is enabled, you must enter the PIN supplied with the SIM or USIM card. You can disable this feature by using the <b>SIM security</b> menu.
PUK	Your SIM or USIM card is blocked, usually as a result of entering your PIN incorrectly several times. You must enter the PUK supplied by your service provider.

## Your device displays network or service error messages

- When you are in areas with weak signals or poor reception, you may lose reception. Move to another area and try again.
- You cannot access some options without a subscription. Contact your service provider for more details.



## The touch screen responds slowly or improperly

If your device has a touch screen and the touch screen is not responding properly, try the following:

- Remove any protective covers from the touch screen. Protective covers may prevent the device from recognising your inputs and are not recommended for touch screen devices.
- Ensure that your hands are clean and dry when tapping the touch screen.
- Restart your device to clear any temporary software bugs.
- Ensure that your device software is upgraded to the latest version.
- If the touch screen is scratched or damaged, take it to your local Samsung Service Centre.

## Your device freezes or has fatal errors

If your device freezes or hangs, you may need to close programs or reset the device to regain functionality. If your device is frozen and unresponsive, press and hold the Power key for 11-13 seconds. The device will power off forcefully.

If this does not solve the problem, perform a factory data reset. In Menu mode, select **Settings** → **system** → **about** → **reset your phone** → **yes** → **yes**.

## Calls are being dropped

When you are in areas with weak signals or poor reception, you may lose your connection to the network. Move to another area and try again.

## Outgoing calls are not connected

- Ensure that you have pressed the Dial key.
- Ensure that you have accessed the right cellular network.
- Ensure that you have not set call barring for the phone number you are dialling.

## Incoming calls are not connected

- Ensure that your device is turned on.
- Ensure that you have accessed the right cellular network.
- Ensure that you have not set call barring for the incoming phone number.

## Others cannot hear you speaking on a call

- Ensure that you are not covering the built-in microphone.
- Ensure that the microphone is close to your mouth.
- If using a headset, ensure that it is properly connected.

## Audio quality is poor

- Ensure that you are not blocking the device's internal antenna.
- When you are in areas with weak signals or poor reception, you may lose reception. Move to another area and try again.

## When dialling from contacts, the call is not connected

- Ensure that the correct number is stored in the contact list.
- Re-enter and save the number, if necessary.
- Ensure that you have not set call barring for the contact's phone number.

## The device beeps and the battery icon is empty

Your battery is low. Recharge or replace the battery to continue using the device.

## The battery does not charge properly or the device turns off

- The battery terminals may be dirty. Wipe both gold-coloured contacts with a clean, soft cloth and try charging the battery again.
- If the battery will no longer charge completely, dispose of the old battery properly and replace it with a new battery (refer to your local ordinances for proper disposal instructions).

## Your device is hot to the touch

When you use applications that require more power or use applications on your device for an extended period of time, your device may feel hot to the touch. This is normal and should not affect your device's lifespan or performance.

## Error messages appear when launching the camera

Your Samsung mobile device must have sufficient available memory and battery power to operate the camera application. If you receive error messages when launching the camera, try the following:

- Charge the battery or replace it with a battery that is fully charged.
- Free some memory by transferring files to a PC or deleting files from your device.
- Restart the device. If you are still having trouble with the camera application after trying these tips, contact a Samsung Service Centre.

## **Error messages appear when launching the FM radio**

The FM radio application on your Samsung mobile device uses the headset cable as an antenna. Without a headset connected, the FM radio will be unable to receive radio stations. To use the FM radio, first ensure that the headset is properly connected. Next, scan for and save the available radio stations.

If you still cannot use the FM radio after performing these steps, try accessing your desired station with another radio receiver. If you can hear the station with another receiver, your device may require service. Contact a Samsung Service Centre.

## **Error messages appear when opening music files**

Some music files may not play on your Samsung mobile device for a variety of reasons. If you receive error messages when opening music files on your device, try the following:

- Free some memory by transferring files to a PC or deleting files from your device.
- Ensure that the music file is not Digital Rights Management (DRM)-protected. If the file is DRM-protected, ensure that you have the appropriate licence or key to play the file.
- Ensure that your device supports the file type.

## **Another Bluetooth device is not located**

- Ensure that the Bluetooth feature is activated on your device.
- Ensure that the Bluetooth feature is activated on the device you wish to connect to, if necessary.
- Ensure that your device and the other Bluetooth device are within the maximum Bluetooth range (10 m).

If the tips above do not solve the problem, contact a Samsung Service Centre.

## A connection is not established when you connect the device to a PC

- Ensure that the USB cable you are using is compatible with your device.
- Ensure that you have the proper drivers installed and updated on your PC.

# Safety precautions

To prevent injury to yourself and others or damage to your device, read all of the following information before using your device.

## Warning: Prevent electric shock, fire, and explosion

**Do not use damaged power cords or plugs, or loose electrical sockets**

**Do not touch the power cord with wet hands, or disconnect the charger by pulling on the cord**

**Do not bend or damage the power cord**

**Do not use your device while charging or touch your device with wet hands**

**Do not short-circuit the charger or the battery**

**Do not drop or cause an impact to the charger or the battery**

**Do not charge the battery with chargers that are not approved by the manufacturer**

**Do not use your device during a thunderstorm**

Your device may malfunction and your risk of electric shock is increased.

**Do not handle a damaged or leaking Lithium Ion (Li-Ion) battery**

For safe disposal of your Li-Ion batteries, contact your nearest authorised service centre.

**Handle and dispose of batteries and chargers with care**

- Use only Samsung-approved batteries and chargers specifically designed for your device. Incompatible batteries and chargers can cause serious injuries or damage to your device.
- Never dispose of batteries or devices in a fire. Follow all local regulations when disposing of used batteries or devices.

- Never place batteries or devices on or in heating devices, such as microwave ovens, stoves, or radiators. Batteries may explode when overheated.
- Never crush or puncture the battery. Avoid exposing the battery to high external pressure, which can lead to an internal short circuit and overheating.

### **Protect the device, batteries, and chargers from damage**

- Avoid exposing your device and batteries to very cold or very hot temperatures.
- Extreme temperatures can cause the deformation of the device and reduce the charging capacity and life of your device and batteries.
- Prevent batteries from contacting metal objects, as this can create a connection between the + and – terminals of your batteries and lead to temporary or permanent battery damage.
- Never use a damaged charger or battery.

## **Caution: Follow all safety warnings and regulations when using your device in restricted areas**

### **Turn off your device where prohibited**

Comply with all regulations that restrict the use of a mobile device in a particular area.

### **Do not use your device near other electronic devices**

Most electronic devices use radio frequency signals. Your device may interfere with other electronic devices.

### **Do not use your device near a pacemaker**

- Avoid using your device within a 15 cm range of a pacemaker if possible, as your device can interfere with the pacemaker.
- If you must use your device, keep it at least 15 cm away from the pacemaker.
- To minimise the possible interference with a pacemaker, use your device on the opposite side of your body from the pacemaker.

### **Do not use your device in a hospital or near medical equipment that can be interfered with by radio frequency**

If you personally use any medical equipment, contact the manufacturer of the equipment to ensure the safety of your equipment from radio frequency.

## **If you are using a hearing aid, contact the manufacturer for information about radio interference**

Some hearing aids may be interfered with by the radio frequency of your device. Contact the manufacturer to ensure the safety of your hearing aid.

## **Turn off the device in potentially explosive environments**

- Turn off your device in potentially explosive environments instead of removing the battery.
- Always comply with regulations, instructions and signs in potentially explosive environments.
- Do not use your device at refuelling points (service stations), near fuels or chemicals, and at blasting areas.
- Do not store or carry flammable liquids, gases, or explosive materials in the same compartment as the device, its parts, or accessories.

## **Turn off your device when in an aircraft**

Using your device in an aircraft is illegal. Your device may interfere with the electronic navigation instruments of the aircraft.

## **Electronic devices in a motor vehicle may malfunction due to the radio frequency of your device**

Electronic devices in your car may malfunction due to radio frequency of your device. Contact the manufacturer for more information.

# **Comply with all safety warnings and regulations regarding mobile device usage while operating a vehicle**

While driving, safely operating the vehicle is your first responsibility. Never use your mobile device while driving, if it is prohibited by law. For your safety and the safety of others, practice good common sense and remember the following tips:

- Get to know your device and its convenience features, such as speed dial and redial. These features help you reduce the time needed to place or receive calls on your mobile device.
- Position your device within easy reach. Be able to access your wireless device without removing your eyes from the road. If you receive an incoming call at an inconvenient time, let your voice mail answer it for you.



- Suspend calls in heavy traffic or hazardous weather conditions. Rain, sleet, snow, ice, and heavy traffic can be hazardous.
- Do not take notes or look up phone numbers. Jotting down a “to do” list or flipping through your address book takes attention away from your primary responsibility of driving safely.
- Dial sensibly and assess the traffic. Place calls when you are not moving or before pulling into traffic. Try to plan calls when your car will be stationary.
- Do not engage in stressful or emotional conversations that may be distracting. Make people you are talking with aware you are driving and suspend conversations that have the potential to divert your attention from the road.
- Use your device to call for help. Dial a local emergency number in the case of fire, traffic accident, or medical emergencies.
- Use your device to help others in emergencies. If you see an auto accident, a crime in progress, or a serious emergency where lives are in danger, call a local emergency number.
- Call roadside assistance or a special, non-emergency assistance number when necessary. If you see a broken-down vehicle posing no serious hazard, a broken traffic signal, a minor traffic accident where no one appears injured, or a vehicle you know to be stolen, call roadside assistance or another special, non-emergency number.

## Proper care and use of your mobile device

### Keep your device dry

- Humidity and all types of liquids may damage device parts or electronic circuits.
- Do not turn on your device if it is wet. If your device is already on, turn it off and remove the battery immediately (if the device will not turn off or you cannot remove the battery, leave it as-is). Then, dry the device with a towel and take it to a service centre.
- Liquids will change the colour of the label that indicates water damage inside the device. Water damage to your device can void your manufacturer’s warranty.

### Do not use or store your device in areas with high concentrations of dust or airborne materials.

Dust or foreign materials can cause your device to malfunction and may result in fire or electric shock.

## **Do not store your device on slopes**

If your device falls, it can be damaged.

## **Do not store your device in hot or cold areas. Use your device at -20 °C to 50 °C**

- Your device can explode if left inside a closed vehicle, as the inside temperature can reach up to 80 °C.
- Do not expose your device to direct sunlight for extended periods of time (such as on the dashboard of a car).
- Store the battery at 0 °C to 40 °C.

## **Do not store your device with such metal objects as coins, keys and necklaces**

- Your device may become deformed or malfunction.
- If the battery terminals are in contact with metal objects, it may cause a fire.

## **Do not store your device near magnetic fields**

- Your device may malfunction or the battery may discharge from exposure to magnetic fields.
- Magnetic stripe cards, including credit cards, phone cards, passbooks, and boarding passes, may be damaged by magnetic fields.
- Do not use carrying cases or accessories with magnetic closures or allow your device to come in contact with magnetic fields for extended periods of time.

## **Do not store your device near or in heaters, microwaves, hot cooking equipment, or high pressure containers**

- The battery may leak.
- Your device may overheat and cause a fire.

## **Do not drop your device or cause impacts to your device**

- The screen of your device may be damaged.
- If bent or deformed, your device may be damaged or parts may malfunction.

## **Do not use your device or applications for a while if the device is overheated**

Prolonged exposure of your skin to an overheated device may cause low temperature burn symptoms, such as red spots and pigmentation.

## **If your device has a camera flash or light, do not use a flash close to the eyes of people or pets**

Using a flash close to the eyes may cause temporary loss of vision or damage to the eyes.

## **Use caution when exposed to flashing lights**

- While using your device, leave some lights on in the room and do not hold the screen too close to your eyes.
- Seizures or blackouts can occur when you are exposed to flashing lights while watching videos or playing Flash-based games for extended periods. If you feel any discomfort, stop using the device immediately.

## **Reduce the risk of repetitive motion injuries**

When you repetitively perform actions, such as pressing keys, drawing characters on a touch screen with your fingers, or playing games, you may experience occasional discomfort in your hands, neck, shoulders, or other parts of your body. When using your device for extended periods, hold the device with a relaxed grip, press the keys lightly, and take frequent breaks. If you continue to have discomfort during or after such use, stop use and see a physician.

## **Ensure maximum battery and charger life**

- Avoid charging batteries for more than a week, as overcharging may shorten battery life.
- Over time, unused batteries will discharge and must be recharged before use.
- Disconnect chargers from power sources when not in use.
- Use batteries only for their intended purposes.

## **Use manufacturer-approved batteries, chargers, accessories and supplies**

- Using generic batteries or chargers may shorten the life of your device or cause the device to malfunction.
- Samsung cannot be responsible for the user's safety when using accessories or supplies that are not approved by Samsung.

## **Do not bite or suck on the device or the battery**

- Doing so may damage the device or cause explosion.
- If children use the device, make sure that they use the device properly.

## **Do not insert the device or supplied accessories into the eyes, ears, or mouth**

Doing so may cause suffocation or serious injuries.

### **When speaking on the device:**

- Hold the device upright, as you would with a traditional phone.
- Speak directly into the mouthpiece.
- Do not touch the device's internal antenna. Doing so may result in reduced call quality or cause the device to emit unintended levels of radio frequency (RF) energy.

### **Protect your hearing and ears when using a headset**



- Excessive exposure to loud sounds can cause hearing damage.
- Exposure to loud sounds while driving may distract your attention and cause an accident.
- Always turn the volume down before plugging the earphones into an audio source and use only the minimum volume setting necessary to hear your conversation or music.
- In dry environments, static electricity can build up in the headset. Avoid using headsets in dry environments or touch a metal object to discharge static electricity before connecting a headset to the device.

### **Use caution when using the device while walking or moving**

- Always be aware of your surroundings to avoid injury to yourself or others.
- Make sure the headset cable does not become entangled in your arms or on nearby objects.

### **Do not carry your device in your back pockets or around your waist**

You can be injured or damage the device if you fall.

### **Do not disassemble, modify, or repair your device**

- Any changes or modifications to your device can void your manufacturer's warranty. For service, take your device to a Samsung Service Centre.
- Do not disassemble or puncture the battery, as this can cause explosion or fire.

## **Do not paint or put stickers on your device**

Paint and stickers can clog moving parts and prevent proper operation. If you are allergic to paint or metal parts of the product, you may experience itching, eczema, or swelling of the skin. When this happens, stop using the product and consult your physician.

## **When cleaning your device:**

- Wipe your device or charger with a towel or an eraser.
- Clean the terminals of the battery with a cotton ball or a towel.
- Do not use chemicals or detergents.

## **Do not use the device if the screen is cracked or broken**

Broken glass or acrylic could cause injury to your hands and face. Take the device to a Samsung Service Centre to have it repaired.

## **Do not use the device for anything other than its intended use**

## **Avoid disturbing others when using the device in public**

## **Do not allow children to use your device**

Your device is not a toy. Do not allow children to play with it as they could hurt themselves and others, damage the device, or make calls that increase your charges.

## **Install mobile devices and equipment with caution**

- Ensure that any mobile devices or related equipment installed in your vehicle are securely mounted.
- Avoid placing your device and accessories near or in an air bag deployment area. Improperly installed wireless equipment can cause serious injury when air bags inflate rapidly.

## **Allow only qualified personnel to service your device**

Allowing unqualified personnel to service your device may result in damage to your device and will void your manufacturer's warranty.

## **Handle SIM cards with care**

- Do not remove a card while the device is transferring or accessing information, as this could result in loss of data and/or damage to the card or device.
- Protect cards from strong shocks, static electricity, and electrical noise from other devices.
- Do not touch gold-coloured contacts or terminals with your fingers or metal objects. If dirty, wipe the card with a soft cloth.

## **Ensure access to emergency services**

Emergency calls from your device may not be possible in some areas or circumstances. Before travelling in remote or undeveloped areas, plan an alternative method of contacting emergency services personnel.

## **Keep your personal and important data safe**

- While using your device, be sure to back up important data. Samsung is not responsible for data loss.
- When disposing of your device, back up all data and then reset your device to prevent misuse of your personal information.
- Carefully read the permissions screen when downloading applications. Be particularly cautious with applications that have access to many functions or to a significant amount of your personal information.
- Check your accounts regularly for unauthorised or suspicious use. If you find any sign of misuse of your personal information, contact your service provider to delete or change your account information.
- In the event your device is lost or stolen, change the passwords on your accounts to protect your personal information.
- Avoid using applications from unknown sources and lock your device with a pattern, password, or PIN.

## **Do not distribute copyright-protected material**

Do not distribute copyright-protected material that you have recorded to others without the permission of the content owners. Doing this may violate copyright laws. The manufacturer is not liable for any legal issues caused by the user's illegal use of copyrighted material.

## Correct disposal of this product

(Waste Electrical & Electronic Equipment)



(Applicable in the European Union and other European countries with separate collection systems)

This marking on the product, accessories or literature indicates that the product and its electronic accessories (e.g. charger, headset, USB cable) should not be disposed of with other household waste at the end of their working life.

To prevent possible harm to the environment or human health from uncontrolled waste disposal, please separate these items from other types of waste and recycle them responsibly to promote the sustainable reuse of material resources.

Household users should contact either the retailer where they purchased this product, or their local government office, for details of where and how they can take these items for environmentally safe recycling.

Business users should contact their supplier and check the terms and conditions of the purchase contract. This product and its electronic accessories should not be mixed with other commercial wastes for disposal.

This EEE is compliant with RoHS.

## Correct disposal of batteries in this product



(Applicable in the European Union and other European countries with separate battery return systems)

This marking on the battery, manual or packaging indicates that the batteries in this product should not be disposed of with other household waste at the end of their working life. Where marked, the chemical symbols Hg, Cd or Pb indicate that the

battery contains mercury, cadmium or lead above the reference levels in EC Directive 2006/66. If batteries are not properly disposed of, these substances can cause harm to human health or the environment.

To protect natural resources and to promote material reuse, please separate batteries from other types of waste and recycle them through your local, free battery return system.

## Disclaimer

Some content and services accessible through this device belong to third parties and are protected by copyright, patent, trademark and/or other intellectual property laws. Such content and services are provided solely for your personal noncommercial use. You may not use any content or services in a manner that has not been authorised by the content owner or service provider. Without limiting the foregoing, unless expressly authorised by the applicable content owner or service provider, you may not modify, copy, republish, upload, post, transmit, translate, sell, create derivative works, exploit, or distribute in any manner or medium any content or services displayed through this device.

“THIRD PARTY CONTENT AND SERVICES ARE PROVIDED “AS IS.” SAMSUNG DOES NOT WARRANT CONTENT OR SERVICES SO PROVIDED, EITHER EXPRESSLY OR IMPLIEDLY, FOR ANY PURPOSE. SAMSUNG EXPRESSLY DISCLAIMS ANY IMPLIED WARRANTIES, INCLUDING BUT NOT LIMITED TO, WARRANTIES OF MERCHANTABILITY OR FITNESS FOR A PARTICULAR PURPOSE. SAMSUNG DOES NOT GUARANTEE THE ACCURACY, VALIDITY, TIMELINESS, LEGALITY, OR COMPLETENESS OF ANY CONTENT OR SERVICE MADE AVAILABLE THROUGH THIS DEVICE AND UNDER NO CIRCUMSTANCES, INCLUDING NEGLIGENCE, SHALL SAMSUNG BE LIABLE, WHETHER IN CONTRACT OR TORT, FOR ANY DIRECT, INDIRECT, INCIDENTAL, SPECIAL OR CONSEQUENTIAL DAMAGES, ATTORNEY FEES, EXPENSES, OR ANY OTHER DAMAGES ARISING OUT OF, OR IN CONNECTION WITH, ANY INFORMATION CONTAINED IN, OR AS A RESULT OF THE USE OF ANY CONTENT OR SERVICE BY YOU OR ANY THIRD PARTY, EVEN IF ADVISED OF THE POSSIBILITY OF SUCH DAMAGES.”

Third party services may be terminated or interrupted at any time, and Samsung makes no representation or warranty that any content or service will remain available for any period of time. Content and services are transmitted by third parties by means of networks and transmission facilities over which Samsung has no control. Without limiting the generality of this disclaimer, Samsung expressly disclaims any responsibility or liability for any interruption or suspension of any content or service made available through this device. Samsung is neither responsible nor liable for customer service related to the content and services. Any question or request for service relating to the content or services should be made directly to the respective content and service providers.



# Index

- access codes 96
- alarms 75
- allshare 72
- auto rejection 33
- battery
  - charging 11
  - installing 9
- Bluetooth 70
- brightness, display 24
- calculator 76
- calendar
  - creating events 60
  - viewing events 60
- call forwarding 33
- calls
  - answering 30
  - international numbers 30
  - making 29
  - multiparty 32
  - rejecting 30
  - using headset 31
  - using options during video 32
  - using options during voice 31
  - viewing missed 32
- camera
  - capturing photos 40
  - capturing videos 43
  - customising camcorder settings 44
  - customising camera settings 42
- connections
  - AllShare 72
  - Bluetooth 70
  - GPS 74
  - Wi-Fi 71
- contacts
  - creating 57
  - finding 58
  - importing 58
  - settings 58
- device
  - customising 23
  - indicator icons 19
  - keys 18
  - layout 16
  - settings 83
  - turning on or off 15
- email
  - sending 37
  - setting accounts 36
  - viewing 37
- flight mode 15
- FM radio
  - listening to 54
  - settings 54
- GPS 74
- internet
  - see web browser
- internet sharing 73

- language 88
- map 64
  - getting directions 66
  - searching for locations 65
- Marketplace 66
- menu screen
  - accessing 22
- messages
  - accessing voice mail 36
  - sending email 37
  - sending multimedia 34
  - sending text 34
  - setting email accounts 36
- mini diary 76
- mobile network sharing 73
- multimedia messages
  - sending 34
  - viewing 35
- music player
  - adding files 51
  - playing music 51
- Now 67
- Office mobile
  - Excel 78
  - managing documents online 80
  - OneNote 77
  - PowerPoint 79
  - Word 79
- phonebook
  - creating contacts 57
  - finding contacts 58
- photos
  - capturing 40
  - editing 47
  - viewing 49
- photo studio 47
- PIN lock 26
- settings 83
  - applications 91
  - system 83
- silent mode 24
- SIM card
  - installing 9
  - locking 26
- Start screen
  - adding items 22
- text input 26
- text messages
  - sending 34
  - viewing 35
- time and date, set 23
- touch screen
  - locking 21
  - using 20
- unpack 9
- USIM card
  - installing 9
  - locking 26
- videos
  - playing 53
  - recording 43
- voice calls
  - answering 30
  - making 29
  - using options 31

voice command 81

voice mail 36

web browser

adding bookmarks 64

browsing web pages 62

Wi-Fi

activating 71

finding and connecting to

networks 71

Zune 51

Some of the contents in this manual may differ from your device depending on the software of the device or your service provider.

**SAMSUNG  
ELECTRONICS**

