

QUESTIONS OR COMMENTS?

COUNTRY	CALL	OR VISIT US ONLINE AT
COSTA RICA	0-800-507-7267 00-800-1-SAMSUNG (726-7864)	www.samsung.com/latin/support (Spanish) www.samsung.com/latin_en/support (English)
DOMINICAN REPUBLIC	1-800-751-2676	www.samsung.com/latin/support (Spanish) www.samsung.com/latin_en/support (English)
ECUADOR	1-800-10-7267 1-800-SAMSUNG (72-6786)	www.samsung.com/latin/support (Spanish) www.samsung.com/latin_en/support (English)
EL SALVADOR	800-6225 800-0726-7864	www.samsung.com/latin/support (Spanish) www.samsung.com/latin_en/support (English)
GUATEMALA	1-800-299-0013 1-800-299-0033	www.samsung.com/latin/support (Spanish) www.samsung.com/latin_en/support (English)
HONDURAS	800-2791-9267 800-2791-9111	www.samsung.com/latin/support (Spanish) www.samsung.com/latin_en/support (English)
JAMAICA	1-800-234-7267 1-800-SAMSUNG (726-7864)	www.samsung.com/latin_en/support (English)
NICARAGUA	001-800-5077267	www.samsung.com/latin/support (Spanish) www.samsung.com/latin_en/support (English)
PANAMA	800-7267 800-0101	www.samsung.com/latin/support (Spanish) www.samsung.com/latin_en/support (English)
PUERTO RICO	1-800-682-3180	www.samsung.com/latin/support (Spanish) www.samsung.com/latin_en/support (English)
TRINIDAD & TOBAGO	1-800-SAMSUNG(726-7864)	www.samsung.com/latin/support (Spanish) www.samsung.com/latin_en/support (English)
UK	0330 SAMSUNG (7267864)	www.samsung.com/uk/support
EIRE	0818 717100	www.samsung.com/ie/support
GERMANY	0180 6 SAMSUNG bzw. 0180 6 7267864* (*0,20 €/Anruf aus dem dt. Festnetz, aus dem Mobilfunk max. 0.60 €/Anruf)	www.samsung.com/de/support
FRANCE	01 48 63 00 00	www.samsung.com/fr/support
ITALIA	800-SAMSUNG (800.7267864)	www.samsung.com/it/support
SPAIN	0034902172678	www.samsung.com/es/support
PORTUGAL	808 20 7267	www.samsung.com/pt/support
LUXEMBURG	261 03 710	www.samsung.com/support
NETHERLANDS	0900-SAMSUNG (0900-7267864) (€ 0,10/Min)	www.samsung.com/nl/support
BELGIUM	02-201-24-18	www.samsung.com/be/support (Dutch) www.samsung.com/be_fr/support (French)
POLAND	801-172-678* lub +48 22 607-93-33 * (* (koszt połączenia według taryfy operatora)	www.samsung.com/pl/support
HUNGARY	0680SAMSUNG (0680-726-786) 0680PREMIUM (0680-773-648)	www.samsung.com/hu/support
SLOVAKIA	0800 - SAMSUNG (0800-726 786) 0800-SAMSUNG (0800-7267864)	www.samsung.com/sk/support
AUSTRIA	[Only for Premium HA] 0800-366661 [Only for Dealers] 0810-112233	www.samsung.com/at/support
SWITZERLAND	0800 726 78 64 (0800-SAMSUNG)	www.samsung.com/ch/support (German) www.samsung.com/ch_fr/support (French)
CZECH	800 - SAMSUNG (800-726786)	www.samsung.com/cz/support
CROATIA	072 726 786	www.samsung.com/hr/support
BOSNIA	055 233 999	www.samsung.com/hr/support
Macedonia	023 207 777	
MONTENEGRO	020 405 888	www.samsung.com/support
SLOVENIA	080 697 267 090 726 786	www.samsung.com/si
SERBIA	011 321 6899	www.samsung.com/rs/support
BULGARIA	800 111 31 , Безплатна телефонна линия	www.samsung.com/bg/support
ROMANIA	08008 726 78 64 (08008 SAMSUNG) Apel GRATUIT	www.samsung.com/ro/support
CYPRUS	8009 4000 only from landline, toll free	www.samsung.com/gr/support
GREECE	80111-SAMSUNG (80111 726 7864) only from land line (+30) 210 6897691 from mobile and land line	www.samsung.com/gr/support
LITHUANIA	8-800-77777	www.samsung.com/lt/support
LATVIA	8000-7267	www.samsung.com/lv/support
INDONESIA	021-56997777 08001128888	www.samsung.com/id/support
PHILIPPINES	1-800-10-7267864 [PLDT] 1-800-8-7267864 [Globe landline and Mobile] 02-4222111 [Other landline]	www.samsung.com/ph/support
INDIA	1800 3000 8282 - Toll Free 1800 266 8282 - Toll Free	www.samsung.com/in/support
TURKEY	444 77 11	www.samsung.com/tr/support
IRAN	021-8255 [CE]	www.samsung.com/iran/support

SAMSUNG ELECTRONICS CO., LTD.

107, Hanamsandan 6beon-ro, Gwangan-gu, Gwangju-si, Korea 506-723

Samsung Electronics (UK) Ltd, Euro QA Lab. Blackbushe Business Park. Saxony Way, Yateley, Hampshire. GU46 6GG United Kingdom



AN026.JSKLKN Series
AN035.JSKLKN Series
AN050.JSKLKN Series
AN080.JSKLKN Series
AN100.JSKLKN Series

ERV(Energy Recovery Ventilator) user manual

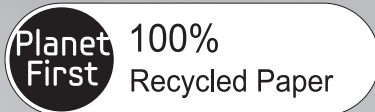

This manual is made with 100% recycled paper.

imagine the possibilities

Thank you for purchasing this Samsung product.

EN ES FR IT PT DE NL DB68-05251A-00



Contents

Preparation

Safety precautions	3
Name of each part	12

Recommendations for use

Cleaning the Dust Filter	14
Cleaning the heat exchange element	16
Final checks & user tips	18
Troubleshooting	19
Model specification (dimension and weight)	19

This product has been determined to be in compliance with the Low Voltage Directive (2006/95/EC), the Electromagnetic Compatibility Directive (2004/108/EC) and the Machinery Directive (2006/42/EC) of the European Union.



Correct Disposal of This Product (Waste Electrical & Electronic Equipment)

(Applicable in countries with separate collection systems)

This marking on the product, accessories or literature indicates that the product and its electronic accessories (e.g. charger, headset, USB cable) should not be disposed of with other household waste at the end of their working life. To prevent possible harm to the environment or human health from uncontrolled waste disposal, please separate these items from other types of waste and recycle them responsibly to promote the sustainable reuse of material resources.







Household users should contact either the retailer where they purchased this product, or their local government office, for details of where and how they can take these items for environmentally safe recycling.

Business users should contact their supplier and check the terms and conditions of the purchase contract. This product and its electronic accessories should not be mixed with other commercial wastes for disposal.

Safety precautions

The following safety precautions are provided to protect the users' safety and prevent property damage.

Make sure to read the followings and use the ventilator properly.

 WARNING	Hazards or unsafe practices that may result in severe personal injury or death.
 CAUTION	Hazards or unsafe practices that may result in minor personal injury or property damage.
	Follow directions.
	Do NOT attempt.
	Cut-off the power supply.
	Do NOT disassemble.
	Make sure the machine is grounded to prevent electric shock.

Safety precautions

FOR INSTALLATION | WARNING

! Use the power line with the power specifications of the product or higher and use the power line for this appliance only. In addition, do not use an extension line.

- ▶ Extending the power line may result in electric shock or fire
- ▶ Do not use an electric transformer. It may result in electric shock or fire.
- ▶ If the voltage/frequency/rated current condition is different, it may cause fire.

The installation of this appliance must be performed by a qualified technician or service company.

- ▶ Failing to do so may result in electric shock, fire, explosion, problems with the product, or injury.

Install a switch and circuit breaker dedicated to the product.

- ▶ Failing to do so may result in electric shock or fire.

Use a rated cable for wiring. Make sure to connect and fix the cables firmly.

- ▶ Failing to do so may result in electric shock or fire.

Install the product firmly on the place that can withstand the weight of the product.

- ▶ Product may fall and get damaged.

- ⊘ **Do not install this appliance near a heater, inflammable material. Do not install this appliance in a humid, oily or dusty location, in a location exposed to direct sunlight and water (rain drops). Do not install this appliance in a location where gas may leak.**

- ▶ This may result in electric shock or fire.

Do not use this product to eliminate humidity in places with high humidity such as basement, parking lot, bathroom etc.

- ▶ When humid air gets inside the product, it may cause electrical failure, fire, electric shock or water leakage.

Do not install the product in places with high humidity and temperature (such as swimming pool, sauna, bathroom) or in a foggy or frosty regions, since condensation may occur within the heat exchange element.

- Ⓧ **This appliance must be properly grounded. Do not ground the appliance to a gas pipe, plastic water pipe, or telephone line.**

- ▶ Failure to do so may result in electric shock, fire, an explosion, or other problems with the product.

- ▶ Never plug the power cord into a socket that is not grounded correctly and make sure that it is in accordance with local and national codes.



Safety precautions

FOR INSTALLATION | CAUTION

- ❗ **Attach a bird screen or equivalent fixture on the air inlet.**
 - ▶ If a bird's nest or other materials blocks air inlet, it may cause oxygen shortage in indoor.
- Use provided accessories and rated parts for an installation.**
 - ▶ Failing to do so may result in electric shock or fire.
- ⊘ **Make sure discharged air does not re-enter indoor through the air inlet.**
 - ▶ This way, fresh air cannot be supplied so indoor air will become polluted and may cause harmful effect.
- Make sure there is no exhaust vent of a burner near air inlet of the product.**
 - ▶ If there's exhaust vent of a burner near air inlet, it may cause oxygen shortage in indoor.
- Do not install the product in a place such as machinery or chemical plants where harmful gases (such as alkaline solution, organic solvent, paint and varnish) are generated.**
 - ▶ If you install the product in such place, it may cause gas poisoning or fire.
- Install the product inside of the adiabatic layer (where outdoor air is isolated).**
 - ▶ If the product is installed outside of the adiabatic layer (such as machine rooms with louver), dew may form at internal part of the product in winter and may cause electric shock or abnormal operation.

FOR POWER

WARNING

-  When the circuit breaker is damaged, contact your nearest service center.
-  Do not pull or excessively bend the power line. Do not twist or tie the power line. Do not hook the power line over a metal object, place a heavy object on the power line, insert the power line between objects, or push the power line into the space behind the appliance.
 - ▶ This may result in electric shock or fire.

FOR POWER

CAUTION

-  When not using the product for a long period of time or during a thunder/lightning storm, cut the power at the circuit breaker.
 - ▶ Failing to do so may result in electric shock or fire.

Safety precautions

FOR USE

 **WARNING**

! If the appliance is flooded, please contact your nearest service center.

▶ Failing to do so may result in electric shock or fire.

If the appliance generates a strange noise, a burning smell or smoke, unplug the power plug immediately and contact your nearest service center.

▶ Failing to do so may result in electric shock or fire.

In the event of a gas leak (such as propane gas, LP gas, etc.), ventilate immediately without touching the power cord. Do not touch the appliance or power cord.

▶ Do not use a ventilating fan.

▶ A spark may result in an explosion or fire.

To reinstall the product, please contact your nearest service center.

▶ Failing to do so may result in problems with the product, water leakage, electric shock, or fire.

▶ A delivery service for the product is not provided. If you reinstall the product in another location, additional construction expenses and an installation fee will be charged.

▶ Especially, when you wish to install the product in an unusual location such as in an industrial area or near the seaside where it is exposed to the salt in the air, please contact your nearest service center.

- ⊘ **Do not strike or pull the product with excessive force.**
 - ▶ This may result in fire, injury, or problems with the product.**Do not turn the product off with the circuit breaker while it is operating.**
 - ▶ Turning the product off and then on again with the circuit breaker may cause a spark and result in electric shock or fire.**After unpacking the product, keep all packaging materials well out of the reach of children, as packaging materials can be dangerous to children.**
 - ▶ If a child places a bag over its head, it may result in suffocation.**Do not insert your fingers or foreign substances into the air inlet/outlet of the product.**
 - ▶ Take special care that children do not injure themselves by inserting their fingers into the product.
- ⊘ **If any foreign substance such as water has entered the appliance, cut the power by unplugging the power plug and turning the circuit breaker off and then contact your nearest service center.**
 - ▶ Failing to do so may result in electric shock or fire.
- ⊘ **Do not attempt to repair, disassemble, or modify the appliance yourself.**
 - ▶ Do not use any fuse (such as copper, steel wire, etc.) other than the standard fuse.
 - ▶ Failing to do so may result in electric shock, fire, problems with the product, or injury.

Safety precautions

FOR USE

 CAUTION

- !** **When combustible gas is leaked from a burner or other product, open the window to ventilate the area.**
 - ▶ Failing to do so may result in fire or explosion.**Do not let the discharged air from the product to blow directly to a burner.**
 - ▶ This will cause incomplete combustion.
- ⊘** **Do not operate the appliance with wet hands.**
 - ▶ This may result in electric shock.**Do not spray volatile material such as insecticide onto the surface of the appliance.**
 - ▶ As well as being harmful to humans, it may also result in electric shock, fire or problems with the product.**Do not use this product to preserve precision equipment, food, animals, plants or cosmetics, or for any other unusual purposes.**
 - ▶ This may result in property damage.**Do not use the product as a main ventilation system of an opened burning type fixture.**
 - ▶ When using a burner that uses gas or petroleum, additional ventilation measure must be considered.**This appliance is not intended for use by persons (including children) with reduced physical, sensory or mental capabilities, or lack of experience and knowledge, unless they have been given supervision or instruction concerning use of the appliance by a person responsible for their safety. Children should be supervised to ensure that they do not play with the appliance.**

For use in Europe: This appliance can be used by children aged from 8 years and above and persons with reduced physical, sensory or mental capabilities or lack of experience and knowledge if they have been given supervision or instruction concerning use of the appliance in a safe way and understand the hazards involved. Children shall not play with the appliance. Cleaning and user maintenance shall not be made by children without supervision.

FOR CLEANING

WARNING

- ⊘ Do not clean the appliance by spraying water directly onto it. Do not use benzene, thinner, alcohol or acetone to clean the appliance.
 - ▶ This may result in discoloration, deformation, damage, electric shock or fire.
- Before cleaning or performing maintenance, cut-off the power supply and wait until the fan stops.**
- ▶ Failing to do so may result in electric shock or fire.

Name of each part

Main parts

AN026**

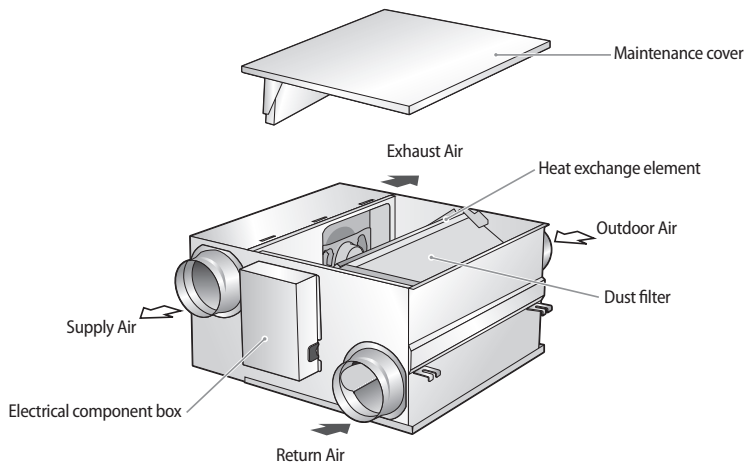

AN035/050/080/100**

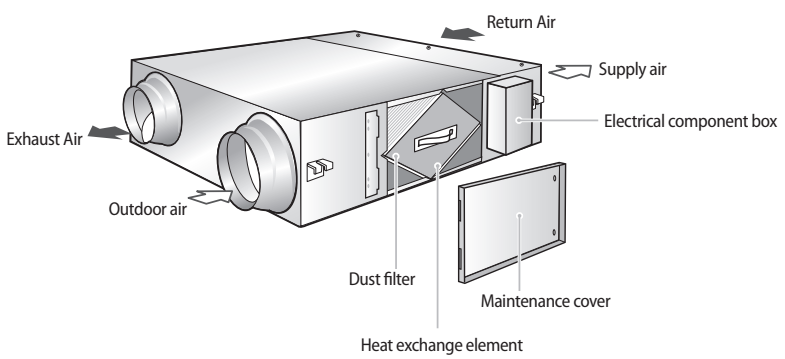

Inspection hole

- ▶ There is an inspection hole for cleaning and maintaining the dust filter and heat exchange element.
- ▶ Lack of installation and maintenance space may cause injury or malfunction.

AN026**

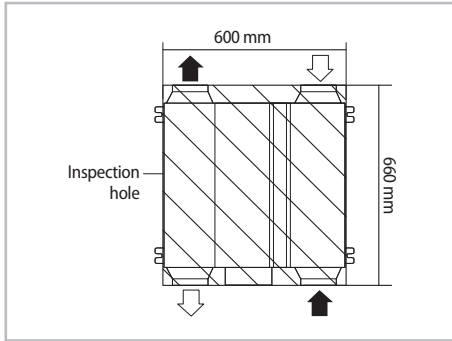

AN035/050/080/100**

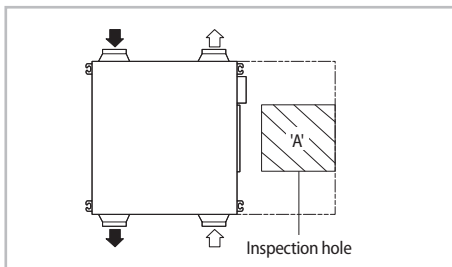

Model	'A' (mm)
AN035/050**	450 X 450
AN080/100**	550 X 550

Cleaning the Dust Filter

AN026**

Clean the dust filters at least twice a year. However, cleaning cycle may vary according to the period of use and condition of the ventilator. Clean the dust filters more frequently in dusty place. Make sure that the power supply is disconnected before cleaning the ventilator.

1. Remove 3 screws on the maintenance cover.
2. Take off the maintenance cover from the ventilator.

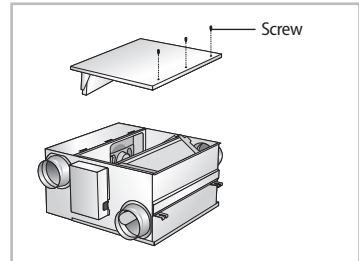

3. Detach the dust filters by pulling them forward.
 - ▶ There are totally 2 dust filters on both sides of the heat exchange element.

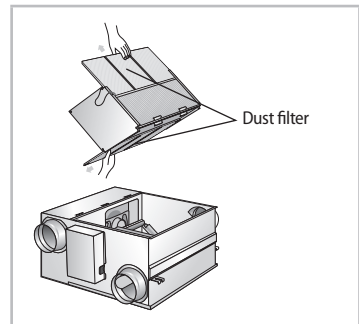

4. Remove all dust on the dust filters with a vacuum cleaner or a brush.

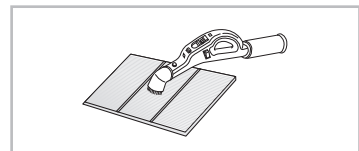

5. Reassemble the dust filters and the maintenance cover.
 - ▶ Make sure to insert the dust filters correctly. The heat exchange element may be covered with dust decreasing the efficiency.



NOTE

- Change the dust filters every two years. However, changing cycle may vary according to the used period and condition.
- If the dust filter is damaged, you can buy a replacement from your supplying agent or customer care center.
- Make sure to turn off the sub power supply.

AN035/050/080/100**

Clean the dust filters at least twice a year. However, cleaning cycle may vary according to the period of use and condition of the ventilator. Clean the dust filters more frequently in dusty place. Make sure that the power supply is disconnected before cleaning the ventilator.

1. Remove 2 screws on the maintenance cover.
2. Take off the maintenance cover from the ventilator.
3. Detach the dust filters by pulling them forward.
 - ▶ There are totally 4 dust filters on both sides of the heat exchange element.
4. Remove all dust on the dust filters with a vacuum cleaner or a brush.
5. Reassemble the dust filters and maintenance cover.
 - ▶ Make sure to insert the dust filters correctly. The heat exchange element may be covered with dust decreasing the efficiency.

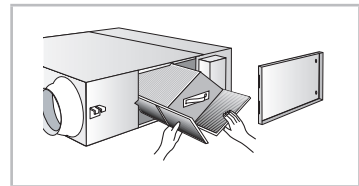
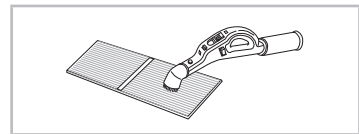
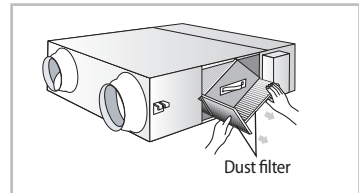
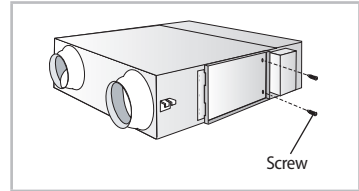

NOTE

- Change the dust filters every two years. However, changing cycle may vary according to the used period and condition.
- If the dust filter is damaged, you can buy a replacement from your supplying agent or customer care center.
- Make sure to turn off the sub power supply.

Cleaning the heat exchange element

AN026**

Clean the heat exchange element at least twice a year. However, the cleaning cycle may vary according to the used period and condition of the ventilator. Clean the heat exchange element more frequently in dusty place. Make sure that the power supply is disconnected before cleaning the ventilator.

1. Remove 3 screws on the maintenance cover.
2. Take off the maintenance cover from the ventilator.

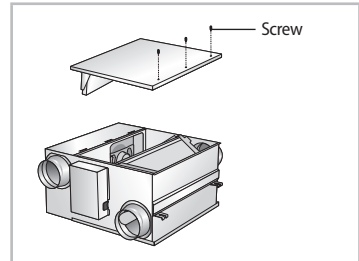

3. Detach the heat exchange element by pulling it upward.

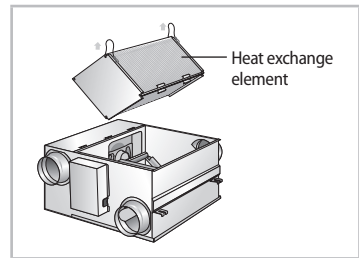

4. Remove all dust and particles on the heat exchange element with a nozzle of a vacuum cleaner.
 - ▶ Take care not to attach the nozzle too close. It may damage the heat exchange element.

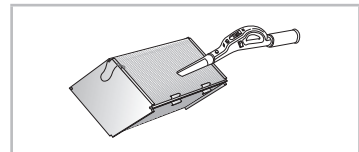

5. Reassemble the heat exchange element and the maintenance cover.



NOTE

- If the heat exchange element is damaged, purchase it individually in a customer care center or an agency that you bought the product.
- Make sure to turn off the sub power supply.



CAUTION

- Do not wash the heat exchange element. It may decrease its efficiency.
- The heat exchange element is heavy. Take care not to drop it.

AN035/050/080/100**

Clean the heat exchange element at least twice a year. However, the cleaning cycle may vary according to the used period and condition of the ventilator. Clean the heat exchange element more frequently in dusty place. Make sure that the power supply is disconnected before cleaning the ventilator.

1. Remove 2 screws on the maintenance cover.
2. Take off the maintenance cover from the ventilator.
3. Detach the 2 heat exchange elements in order.
 - ▶ There are 2 heat exchange elements in the ventilator. Make sure clean them at once.
4. Remove all dust on the dust filters with a vacuum cleaner or a brush.
 - ▶ Take care not to attach the nozzle too close. It may damage the heat exchange element.
5. Reassemble the heat exchange elements and maintenance cover.

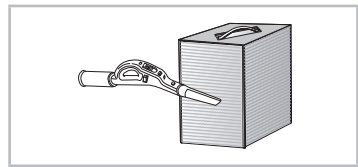
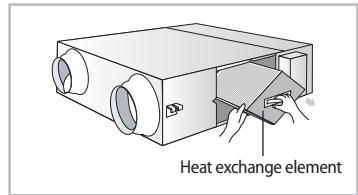
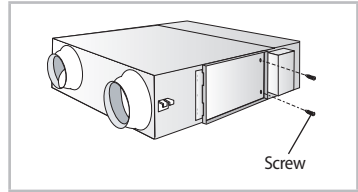

NOTE

- If the heat exchange element is damaged, purchase it individually in a customer care center or an agency that you bought the product.
- Make sure to turn off the sub power supply.



CAUTION

- Do not wash the heat exchange element. It may decrease its efficiency.
- The heat exchange element is heavy. Take care not to drop it.

Final checks & user tips

Checking up the sub power supply

The sub power supply is a device to prevent electric leakage due to the over current. Install the sub power supply separately near the ventilator and turn it off when you clean the ventilator or you do not use the ventilator for a long period of time.

- ▶ Turn on the sub power supply which is installed separately.
 - The sub power supply is not supplied with the ventilator. Purchase the sub power supply individually.

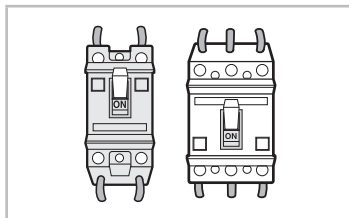

NOTE

- If the circuit breaker (MCCB, ELB) is installed, the sub power supply does not need to be installed mandatorily.
- Power supplies should only checked by qualified specialists.

Recommended Operation Condition

- ▶ Install and operate the ventilator in between -15°C and 40°C . If the ventilator is operated under the condition other than are indicated, it may not operate due to the protective device in the ventilator. Especially, if outside temperature is under -15°C , the ventilator does not operate at all.
- ▶ Do not operate the ventilator when typhoon comes. Water may get in the room through the ventilator due to the rain and heavy winds.
- ▶ Avoid operating the ventilator in indoor or outdoor with high temperature and humidity since dew may form on the internal part of the product, including the heat exchanger. Especially avoid using it during the long rainy period in the summer.

Install condition	Outdoor air condition	Indoor air condition
0~40 °C, 80 % RH below	-15~40 °C, 80 % RH below	0~40 °C, 80 % RH below

Troubleshooting

Problem	Explanation/Solution
The ventilator does not operate	<ul style="list-style-type: none"> • Check a power failure. • Check the sub power supply is on.
The air does not come out from the air outlet	<ul style="list-style-type: none"> • Check whether dust filter or heat exchange element is blocked by dust. In case of dust accumulation, it may decrease the efficiency of the ventilator. Clean the dust filter and the heat exchange element frequently. • Check whether the air intake or outlet is blocked by dust. Remove all dust in the air intake.
Water drops from the air intake	<ul style="list-style-type: none"> • Check whether the ventilator is operated in By-Pass mode during heating. When heating, make sure to operate the ventilator in Heat-EX mode.

Model specification (dimension and weight)

Model	Net dimension (WxDxH, mm)	Net weight (kg)
AN026JSKLN/EU	660 x 600 x 350	28.5
AN035JSKLN/EU	1012 x 1000 x 270	42.5
AN050JSKLN/EU	1012 x 1000 x 270	42.5
AN080JSKLN/EU	1220 x 1135 x 340	67.0
AN100JSKLN/EU	1220 x 1135 x 340	67.0