



# features of your new air conditioner

---

- **Cool Summer Offer**

On those hot sweltering summer days and long restless nights, there is no better escape from the heat than the cool comforts of home. Your new air conditioner brings an end to exhausting hot summer days and lets you rest. This summer, beat the heat with your own air conditioner.

- **Cost Efficient System**

Your new air conditioner not only provides maximum cooling power in the summer, but can also be an efficient heating method in the winter with the advanced “Heat pump” system. This technology is up to 300% more efficient than electrical heating, so you can further reduce its running cost. Now, meet year-round needs with one air conditioner.

- **Flexible installation**

Duct type air conditioner is designed to be slimmer and offers different solutions for any shape room allowing for specific air flow requirements. Also, the air intake can be set up on either the bottom or rear of the unit, so there is more flexibility in installation.



For easy future reference write the model and serial number down. You will find your model number on the right side of the air conditioner.

Model # \_\_\_\_\_  
Serial # \_\_\_\_\_

# safety information











To prevent electric shock, disconnect the power before servicing, cleaning, and installing the air conditioner.

## SAFETY INFORMATION

Before using your new air conditioner, please read this manual thoroughly to ensure that you know how to safely and efficiently operate the extensive features and functions of your new appliance.

Because the following operating instructions cover various models, the characteristics of your air conditioner may differ slightly from those described in this manual. If you have any questions, call your nearest contact center or find help and information online at [www.samsung.com](http://www.samsung.com).

### Important safety symbols and precautions:

 <b>WARNING</b>	Hazards or unsafe practices that may result in <b>severe personal injury or death.</b>
 <b>CAUTION</b>	Hazards or unsafe practices that may result in <b>minor personal injury or property damage.</b>
 <b>CAUTION</b>	To reduce the risk of fire, explosion, electric shock, or personal injury when using your air conditioner, follow these basic safety precautions:
	Do NOT attempt.
	Do NOT disassemble.
	Do NOT touch.
	Follow directions carefully.
	Cut-off the power supply.
	Make sure the machine is grounded to prevent electric shock.
	Call the contact center for help.
	Note.

**These warning signs are here to prevent injury to you and others. Please follow them carefully.**

**After reading this section, keep it in a safe place for future reference.**

# safety information

---

## SEVERE WARNING SIGNS

---

- Do not place the air conditioner near hazardous substances or equipment that releases free flames to avoid fire, explosions or injuries.**

- Potential risk of fire hazard or explosion.

**Do not install the outdoor unit at an unstable place or elevated surface where there is potential risk of falling.**

- If the outdoor unit falls, it may cause personal injury or loss of property.

**Failure or damage may occur if any changes or modification that is not stated in the installation manual was performed. In this case, user will be responsible for the repair expenses.**

**Install the air conditioner away from direct exposure to sunlight, heating apparatus, and humid places.**

- Hang curtains on windows to boost cooling efficiency and to avoid the risk of electric shock.

**Use the power line with the power specifications of the product or higher and use the power line for this appliance only. In addition, do not use an extension line.**

- Extending the power line may result in electric shock or fire.

**Install an exclusive circuit breaker and short-circuit breaker for the air conditioner.**

- Potential risk of electric shock or fire.

**Do not insert anything such as fingers or branches into the air conditioner vents while the air conditioner is running.**

- Keep the children away from the air conditioner to prevent them from putting their finger on the air conditioner. Potential risk of personal injury.

**If any foreign substance such as water has entered the appliance, cut-off the power supply and contact the nearest service center.**

- Failing to do so may result in electric shock or fire.

**Turn off the air conditioner using the provided remote control or control accessory (if provided). Do not cut-off the power supply to turn off the unit (unless there is an immediate danger).**

**Do not run the air conditioner for an extended period of time in a room with the door closed or with babies, elderly or disabled people.**

- Open the door or windows to ventilate your room at least once an hour to prevent oxygen shortage.

**The air conditioner is composed of moving parts. Keep children away from the unit to avoid physical injury.**

- Make sure that children take precautions against access to the air conditioner and they do not play with the unit.**

**Do not clean the interior of air conditioner on your own.**

- You may damage the parts which can cause electric shock or fire.

- Consult contact center for cleaning the interior of the air conditioner.

---

 **Do not connect the air conditioner with heating apparatus or attempt to disassemble, remodel or repair it yourself.**

- Potential risk of malfunction, electric shock or fire. If repairs are needed, consult the contact center.

---

 **Consult the place of purchase or contact center to install, reinstall or disassemble the air conditioner.**

- Improper installation carries a risk of unit malfunction, water leakage, electric shock or fire.
- If installing in specialty areas, such as a factory complex or saline coastal area, consult the place of purchase or contact center for specific installation details.
- The units must be installed according to distances declared, in order to permit accessibility from each side, either to guarantee correct operation of maintenance or repairing products. The unit's parts must be reachable and removable completely under safety condition (for people or things).

**Consult a dealer regarding the appropriate measures to prevent the allowable concentration from being exceeded.**

- If the refrigerant leaks, and cause the concentration limit to be exceeded, hazards due to lack of oxygen in the room may result.

**If the indoor unit gets wet, turn the power off immediately and call your nearest contact center.**

- Potential risk of fire or electric shock.

**Always make sure that the power supply is compliant with current safety standards. Always install the air conditioner in compliance with current local safety standards.**

**Verify that the voltage and frequency of the power supply comply with the specifications and that the installed power is sufficient to ensure the operation of any other domestic appliance connected to the same electric lines.**

**Use a rated circuit breaker only.**

- Never use steel wires or copper wires as a circuit breaker. It may cause fire or unit malfunctions.

**Do not put undue stress or place heavy object on the power cable.**

**Do not bend the power cable excessively.**

- Potential risk of fire or electric shock.

**To protect the product from water and possible shock, you should keep the power cable and the connection cord of the indoor and outdoor units in the protection tube.**

**When opening or closing the front panel, use a stable stool and watch your steps carefully.**

---

 **Disconnect the air conditioner from power supply before it is repaired or disassembled.**

**Clean the air conditioner after the inner fan stops operating.**



- Potential risk of injury or electric shock.

# safety information

---

## SEVERE WARNING SIGNS (CONT'D)

---

-  **Use a receptacle that has a ground terminal. The receptacle must be used exclusively for the air conditioner.**
- Improper electrical grounding may cause electric shock or fire.
- Be sure to ground the unit. Do not connect the ground wire to gas or water pipes, lighting rods, or telephone grounding lines.**
- If the unit is not properly grounded, electric shock may result.
-  **If the appliance generates a strange noise, a burning smell or smoke, cut-off the power supply immediately and contact the nearest service center.**
- Potential risk of fire or electric shock.

## CAUTION SIGNS

---

-  **Do not block or place items in front of the air conditioner. Do not step, hang onto, or place heavy items on the air conditioner.**
- Potential risk of personal injury.
- If failure or damage occurs on the conditions of improper use not followed by the installation manual, there will be an extra labor charge for installing and construction.**
- Potential risk of malfunction, electric shock or fire if repairs or installations are attempted by a non-qualified service technician.
- Do not spray flammable gases such as insecticide near the air conditioner.**
- Potential risk of electric shock, fire or unit malfunction.
- Do not open the front grille during operation.**
- Potential risk of electric shock or unit malfunction.
- Cool air should not flow directly towards people, pets, and plants.**
- It is harmful to your health, pets, and plants.
- Do not drink drain water coming out of the air conditioner.**
- Potential risk of health hazard.
- Do not allow children to climb on the air conditioner.**
- Do not use the air conditioner as a cooling precision instrument for food, pets, plants, cosmetics or machinery.**
- Do not pull or give excessive shock to the air conditioner.**
- Potential risk of fire, or unit malfunction and there are risk of personal injury because unit may fall down.
- Do not spray water directly on the air conditioner or use benzene, thinner or alcohol to clean the surface of the unit.**
- Potential risk of electric shock or fire.
  - Potential risk of damage to the air conditioner.
- Do not place any objects, especially containers with liquid.**



**Do not touch the pipe connected to the air conditioner.**



**Install the indoor unit away from lighting apparatus using the ballast.**

- If you use the wireless remote control, reception error may occur due to the ballast of the lighting apparatus.

**Install the outdoor unit where operating noise and vibration will not disturb your neighbor and in a well-ventilated area with no obstacle.**

- Potential risk of malfunction.
- Operating noise may disturb your neighbor.

**Make sure that there are no obstacles or covers that block the air conditioner.**

**Allow sufficient space for air circulation.**

- Insufficient ventilation may result in poor performance.

**If the power cable is damaged, the manufacturer or a qualified service technician must replace it.**

**If a power outage occurs while the air conditioner is working, turn off the power source immediately.**

**Max current is measured according to IEC standard for safety and current is measured according to ISO standard for energy efficiency.**

**Check for damage on delivery. If damaged, do not install the air conditioner and call the place of purchase immediately.**

**Keep indoor temperatures stable and not extremely cold, especially where there are children, elderly or disabled people.**

**The packaging material and used batteries of the remote controller (optional) must be disposed of in accordance with the national standards.**

**The refrigerant used in the air conditioner must be treated as chemical waste. Dispose the refrigerant following national standards.**

**Have a qualified service technician install the air conditioner and perform a trial operation.**

**Firmly connect the drain hose to the air conditioner for proper water drainage.**

**Check for damages on the outdoor unit installation pad at least once a year.**

- Potential risk of personal injury or property loss.

**When using a wireless remote control, the distance should not be more than 7 meters from the air conditioner.**

**If the remote control is not used for a long period of time, remove the batteries to prevent leakage of electrolyte.**

**When cleaning the outdoor unit, touch the heat exchanger radiator fins with extreme care.**

- Wearing thick gloves can protect your hands.

**Make sure that the condensed water dripping from the drain hose runs out properly and safely.**

# safety information

---

The appliance is not intended for use by persons (including children) with reduced physical, sensory or mental capabilities, or lack of experience and knowledge, unless they have been given supervision or instruction concerning use of the appliance by a person responsible for their safety: Young children should be supervised to ensure that they do not play with the appliance.

For use in Europe : This appliance can be used by children aged from 8 years and above and persons with reduced physical, sensory or mental capabilities or lack of experience and knowledge if they have been given supervision or instruction concerning use of the appliance in a safe way and understand the hazards involved. Children shall not play with the appliance. Cleaning and user maintenance shall not be made by children without supervision.



## CAUTION SIGNS (CONT'D)

---

- ★ Inspect the condition, electric connections, pipes and external case of the air conditioner regularly by a qualified service technician.

Do not open doors and windows in the room being cooled during operation unless necessary.

Do not block the air conditioner vents. If objects block the air flow, it may cause unit malfunction or poor performance.

Make sure there are no obstacles under the indoor unit.

- Potential risk of fire or loss of property.

The air conditioner should be used only for the applications for which it has been designed: the indoor unit is not suitable to be installed in areas used for laundry.

Our units must be installed in compliance with the spaces indicated in the installation manual to ensure either accessibility from both sides or ability to perform routine maintenance and repairs. The units' components must be accessible and that can be disassembled in conditions of complete safety either for people or things.

For this reason, where it is not observed as indicated into the Installation Manual, the cost necessary to reach and repair the unit (in safety, as required by current regulations in force) with slings, trucks, scaffolding or any other means of elevation won't be considered in-warranty and charged to end user.

- 
- ☞ Ensure the off-on and protection switches are properly installed.

Do not use the air conditioner if damaged. If problems occur, immediately stop operation and cut-off the power supply.

When not using the air conditioner for a long period of time or during a thunder/lightning storm, cut the power at the circuit breaker.

- 
- ☞ Call the place of purchase or a contact center if repairs are needed.

- Potential risk of fire or electric shock if disassembly or repairs are attempted by a non-qualified service technician.



# contents

<b>VIEWING YOUR AIR CONDITIONER</b>	<b>10</b>	<b>Slim duct type</b>
		<b>10</b> MA duct type
	10	
<b>USING YOUR AIR CONDITIONER</b>	<b>11</b>	<b>Tips on using your air conditioner</b>
	11	
<b>CLEANING AND MAINTAINING THE AIR CONDITIONER</b>	<b>12</b>	<b>Cleaning the filter</b>
	12	Slim duct type
	13	MA duct type
	<b>14</b>	<b>Maintaining your air conditioner</b>
	14	Periodical checks
	15	Internal protections via the unit control system
<b>APPENDIX</b>	<b>16</b>	<b>Troubleshooting</b>
	16	
	<b>17</b>	<b>Operation ranges</b>
	17	
<b>INSTALLING YOUR AIR CONDITIONER</b>	<b>18</b>	<b>Installation part</b>
	18	

This product has been determined to be in compliance with the Low Voltage Directive (2006/95/EC) and the Electromagnetic Compatibility Directive (2004/108/EC) of the European Union.



### **Correct Disposal of This Product (Waste Electrical & Electronic Equipment)**

#### **(Applicable in countries with separate collection systems)**

This marking on the product, accessories or literature indicates that the product and its electronic accessories (e.g. charger, headset, USB cable) should not be disposed of with other household waste at the end of their working life. To prevent possible harm to the environment or human health from uncontrolled waste disposal, please separate these items from other types of waste and recycle them responsibly to promote the sustainable reuse of material resources.

Household users should contact either the retailer where they purchased this product, or their local government office, for details of where and how they can take these items for environmentally safe recycling.

Business users should contact their supplier and check the terms and conditions of the purchase contract. This product and its electronic accessories should not be mixed with other commercial wastes for disposal.

# viewing your air conditioner

---

Congratulations on the purchase of the air conditioner. We hope you enjoy the features of your air conditioner and stay cool or warm with optimal efficiency.

Please read the user manual to get started and to make the best use of the air conditioner.

## SLIM DUCT TYPE

---

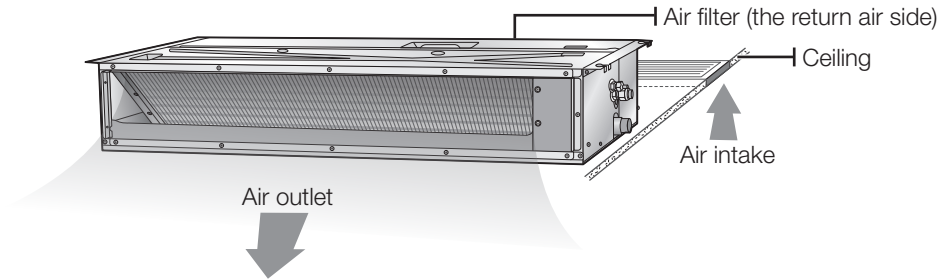

## MA DUCT TYPE

---

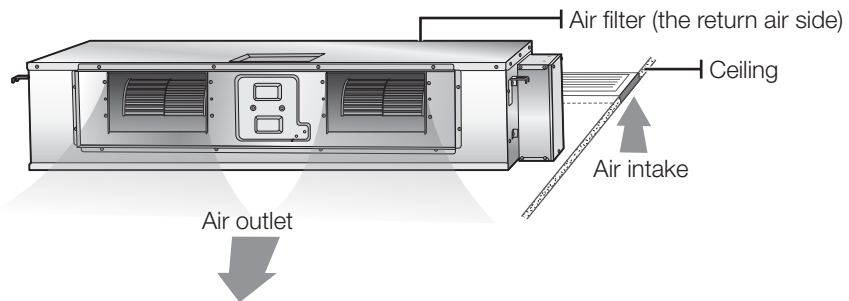

 Your air conditioner may look slightly different from the illustration shown above depending on your model.

# using your air conditioner

## TIPS ON USING YOUR AIR CONDITIONER

Here are some tips that you would follow when using your air conditioner.

TOPIC	RECOMMENDATION
Cooling	<ul style="list-style-type: none"><li>• If current outside temperatures are much higher than the selected indoor temperature, it may take time to bring the inner temperature to the desired coolness.</li><li>• Avoid drastically turning down the temperature. Energy is wasted and the room does not cool faster.</li></ul>
Heating	<ul style="list-style-type: none"><li>• Since the air conditioner heats the room by taking heat energy from outdoor air, the heating capacity may decrease when outdoor temperatures are extremely low. If you feel the air conditioner insufficiently heats, using an additional heating appliance in combination with the air conditioner is recommended.</li></ul>
Frost & De-ice	<ul style="list-style-type: none"><li>• When the air conditioner runs in Heat mode, due to temperature difference between the unit and the outside air, frost will form. If this happens:<ul style="list-style-type: none"><li>- The air conditioner stops heating.</li><li>- The air conditioner will operate automatically in De-ice mode for 10 minutes.</li><li>- The steam produced on the outdoor unit in De-ice mode is safe.</li></ul>No intervention is required; after about 10 minutes, the air conditioner operates again normally.</li></ul>  The unit will not operate when it starts to de-ice.
Fan	<ul style="list-style-type: none"><li>• Fan may not operate for about 3~5 minutes at the beginning to prevent any cold blasts while the air conditioner is warming up.</li></ul>
High indoor/outdoor temperatures	<ul style="list-style-type: none"><li>• If both indoor and outdoor temperatures are high and the air conditioner is running in Heat mode, the outdoor unit's fan and compressor may stop at times. This is normal; wait until the air conditioner turns on again.</li></ul>
Power failure	<ul style="list-style-type: none"><li>• If a power failure occurs during the operation of the air conditioner, the operating immediately stops and unit will be off. When power returns, the air conditioner will run automatically.</li></ul>
Protection mechanism	<ul style="list-style-type: none"><li>• If the air conditioner has just been turned on after operation stops or power being supplied, cool/warm air does not come out for 3 minutes to protect the compressor of the outdoor unit.</li></ul>

# cleaning and maintaining the air conditioner

For the best performance from your air conditioner, clean it periodically. When cleaning, make sure to cut-off the power supply from the unit for user's safety.

## CLEANING THE FILTER

When cleaning the filter, make sure to turn off the power of the indoor unit. Washable foam based Air filter captures large particles from the air. The filter is cleaned with a vacuum or by hand washing.

### Slim duct type

1. Slide out the Air filter on the rear side panel to the right side.

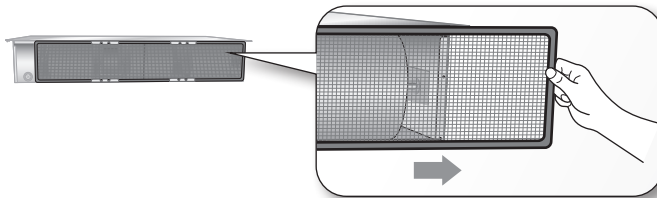

2. Clean the Air filter with a vacuum cleaner or soft brush. If dust is too heavy, then rinse it with running water and dry it in a ventilated area.

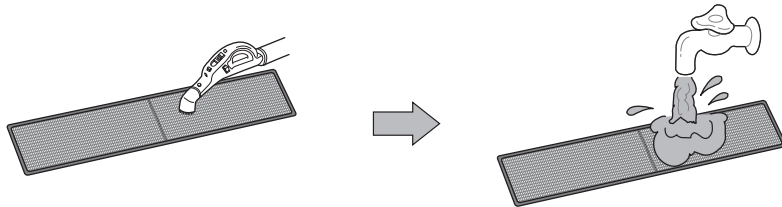

- ☑ For best conditions, repeat every two weeks.
- If the Air filter dries in a confined (or humid) area, odors may generate. If it occurs, re-clean and dry it in a ventilated area.

3. Insert the Air filter back in its original position.

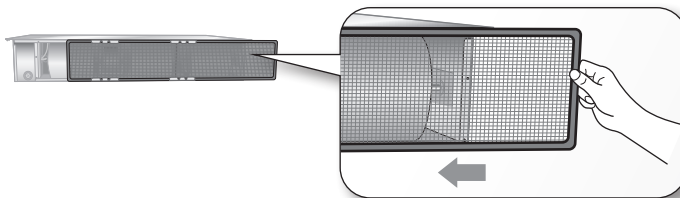

- ☑ The illustration shown above may differ from your depending on your model.
- After cleaning the filter, press the **Filter Reset** button on the remote control for 2 seconds to reset the filter schedule. Filter sign indicator will be on for cleaning time.

## MA duct type

1. Slide out the Air filter on the rear side panel to the right side.

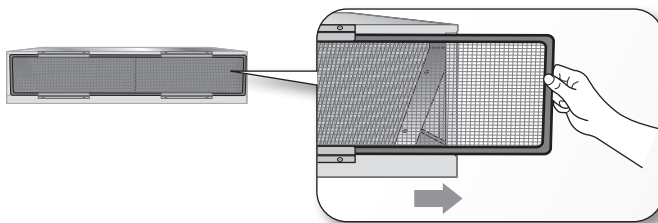

2. Clean the Air filter with a vacuum cleaner or soft brush. If dust is too heavy, then rinse it with running water and dry it in a ventilated area.

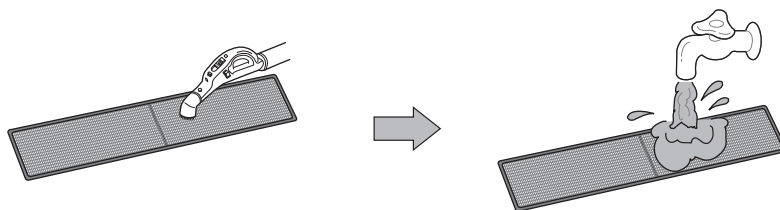

- ☑ • For best conditions, repeat every two weeks.
- If the Air filter dries in a confined (or humid) area, odors may generate. If it occurs, re-clean and dry it in a ventilated area.

3. Insert the Air filter back in its original position.

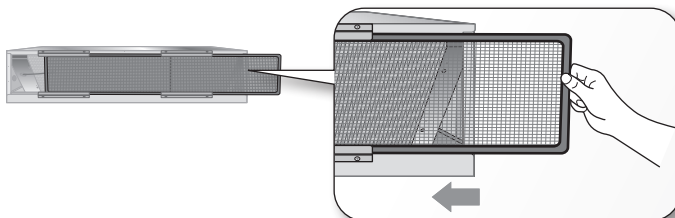

- ☑ • The illustration shown above may differ from your depending on your model.
- After cleaning the filter, press the **Filter Reset** button on the remote control for 2 seconds to reset the filter schedule. Filter sign indicator will be on for cleaning time.

# cleaning and maintaining the air conditioner

## MAINTAINING YOUR AIR CONDITIONER

If the air conditioner will not be used for an extended period of time, dry the air conditioner to maintain it in best condition.

1. Dry the air conditioner thoroughly by operating in Fan mode for 3 to 4 hours and cut-off the power supply. There may be internal damage if moisture is left in components.
2. Before using the air conditioner again, dry the inner components of the air conditioner again by running in Fan mode for 3 to 4 hours. This helps remove odors which may have generated from dampness.

### Periodical checks

Refer to the following chart to maintain the air conditioner properly.

Type	Description	Monthly	Every 4 months	Once a year
Indoor unit	Clean the air filter (1)	●		
	Clean the condensate drain pan (2)			●
	Thoroughly clean the heat exchanger (2)			●
	Clean the condensate drain pipe (2)		●	
	Replace the remote control batteries (1)			●
Outdoor unit	Clean the heat exchanger on the outside of the unit (2)		●	
	Clean the heat exchanger on the inside of the unit (2)			●
	Clean the electric components with jets of air (2)			●
	Verify that all the electric components are firmly tightened (2)			●
	Clean the fan (2)			●
	Verify that all the fan assembly is firmly tightened (2)			●
	Clean the condensate drain pan (2)			●

 The checks and maintenance operations described are essential to guarantee the efficiency of the air conditioner. The frequency of these operations varies according to the characteristics of the area, the amount of dust, etc.

- (1) The described operations should be performed more frequently if the area of installation is very dusty.
- (2) These operations must always be performed by qualified personnel. For more detailed information, see the Installation Manual.

## Internal protections via the unit control system

This internal protection operates if an internal fault occurs in the air conditioner.

Type	Description
Against cold air	The internal fan will be off to against cold air when the heat pump is heating.
De-ice cycle	The internal fan will be off to against cold air when the heat pump is heating.
Anti-protection of internal battery	The compressor will be off to protect internal battery when the air conditioner operates in Cool mode.
Protect compressor	The air conditioner does not start operating immediately to protect the compressor of the outdoor unit after it has been started.



If the heat pump is operating in Heat mode, De-ice cycle is actuated to remove frost from an outdoor unit that may have deposited at low temperatures.

The internal fan is switched off automatically and restarted only after the de-ice cycle is completed.

# appendix

---

## TROUBLESHOOTING

---

Refer to the following chart if the air conditioner operates abnormally. This may save time and unnecessary expenses.

PROBLEM	SOLUTION
The air conditioner does not operate immediately after it has been restarted.	<ul style="list-style-type: none"><li>• Because of the protective mechanism, the appliance does not start operating immediately to keep the unit from overloading. The air conditioner will start in 3 minutes.</li></ul>
The air conditioner does not work at all.	<ul style="list-style-type: none"><li>• Check power status and then operate the air conditioner again.</li><li>• Check if the circuit breaker is switched off.</li><li>• Check if there is a power failure.</li><li>• Check your fuse. Make sure it is not blown out.</li></ul>
The temperature does not change.	<ul style="list-style-type: none"><li>• Check if you selected Fan mode. Press the <b>Mode</b> button on the remote control to select another mode.</li></ul>
The cool (warm) air does not come out of the air conditioner.	<ul style="list-style-type: none"><li>• Check if the set temperature is higher (lower) than the current temperature. Press the <b>Temperature</b> button on the remote control to change the set temperature. Press the <b>Temperature</b> button to decrease or increase the temperature.</li><li>• Check if the air filter is blocked by dirt. Clean the air filter every two weeks.</li><li>• Check if the air conditioner has just been turned on. If so, wait 3 minutes. Cool air does not come out to protect the compressor of the outdoor unit.</li><li>• Check if the air conditioner is installed in a place with a direct exposure to sunlight. Hang curtains on windows to boost cooling efficiency.</li><li>• Check if the cover or any obstacle is not near the outdoor unit.</li><li>• Check if the refrigerant pipe is too long.</li><li>• Check if the air conditioner is only available in Cool mode.</li><li>• Check if the remote control is only available for cooling model.</li></ul>
The fan speed does not change.	<ul style="list-style-type: none"><li>• Check if you selected Auto or Dry mode. The air conditioner automatically adjusts the fan speed to Auto in Auto/Dry mode.</li></ul>
Timer function does not set.	<ul style="list-style-type: none"><li>• Check if you press the <b>Power</b> button on the remote control after you have set the time.</li></ul>
Odors permeate in the room during operation.	<ul style="list-style-type: none"><li>• Check if the appliance is running in a smoky area or if there is a smell entering from outside. Operate the air conditioner in Fan mode or open the windows to air out the room.</li></ul>



<b>The air conditioner makes a bubbling sound.</b>	<ul style="list-style-type: none"> <li>• A bubbling sound may be heard when the refrigerant is circulating through the compressor. Let the air conditioner operate in a selected mode.</li> <li>• When you press the <b>Power</b> button on the remote control, noise may be heard from the drain pump inside the air conditioner.</li> </ul>
<b>Water is dripping from the air flow blades.</b>	<ul style="list-style-type: none"> <li>• Check if the air conditioner has been cooling for an extended period of time with the air flow blades pointed downwards. Condensation may generate due to the difference in temperature.</li> </ul>
<b>Remote control is not working.</b>	<ul style="list-style-type: none"> <li>• Check if your batteries are depleted.</li> <li>• Make sure batteries are correctly installed.</li> <li>• Make sure nothing is blocking your remote control sensor.</li> <li>• Check that there are strong lighting apparatus near the air conditioner. Strong light which comes from fluorescent bulbs or neon signs may interrupt the electric waves.</li> </ul>
<b>The air conditioner does not turn on or off with the wired remote control.</b>	<ul style="list-style-type: none"> <li>• Check if you set the wired remote control for group control.</li> </ul>
<b>The wired remote control does not operate.</b>	<ul style="list-style-type: none"> <li>• Check if TEST indicator is displayed on the wired remote control. If so, turn off the unit and switch off the circuit breaker. Call your nearest contact center.</li> </ul>
<b>The indicators of the digital display flashes.</b>	<ul style="list-style-type: none"> <li>• Press the <b>Power</b> button on the remote control to turn the unit off and switch the circuit breaker off. Then, switch it on again.</li> </ul>

## OPERATION RANGES

The table below indicates the temperature and humidity ranges the air conditioner can be operated within. Refer to the table for efficient use.

MODE	OPERATIONAL TEMPERATURE		INDOOR HUMIDITY	IF OUT OF CONDITIONS
	INDOOR	OUTDOOR		
COOLING	16°C to 32°C	-5°C to 43°C	80% or less	Condensation may occur on the indoor unit with risk to have either water blow off or drops on the floor.
HEATING	27°C or less	-15°C to 24°C	-	Internal protection triggers and the air conditioner will stop.
DRYING	16°C to 32°C	-5°C to 43°C	-	Condensation may occur on the indoor unit with risk to have either water blow off or drops on the floor.



The standardized temperature for heating is 7°C. If the outdoor temperature drops to 0°C or below, the heating capacity can be reduced depending on the temperature condition.  
If the cooling operation is used at over 32°C(indoor temperature), it does not cool at its full capacity.

## QUESTIONS OR COMMENTS?

COUNTRY	CALL	OR VISIT US ONLINE AT	COUNTRY	CALL	OR VISIT US ONLINE AT
AUSTRIA	0810 - SAMSUNG (7267864, € 0.07/min)	www.samsung.com	UKRAINE	0-800-502-000	www.samsung.com/ua (Ukrainian) www.samsung.com/ua_ru (Russian)
BELGIUM	02-201-24-18	www.samsung.com/be (Dutch) www.samsung.com/be_fr (French)	MOLDOVA	0-800-614-40	www.samsung.com
BOSNIA	051 133 1999	www.samsung.com	U.A.E	800-SAMSUNG (726-7864)	www.samsung.com
BULGARIA	07001 33 11 , share cost tariff	www.samsung.com/bg	OMAN	800-SAMSUNG(726-7864)	www.samsung.com/ae (English) www.samsung.com/ae_ar (Arabic)
CROATIA	062 SAMSUNG (062 726 786)	www.samsung.com/hr	KUWAIT	183-2255 (183-CALL)	www.samsung.com/ae (English) www.samsung.com/ae_ar (Arabic)
CZECH	800 - SAMSUNG (800-726786)	www.samsung.com	BAHRAIN	8000-4726	www.samsung.com/ae (English) www.samsung.com/ae_ar (Arabic)
DENMARK	70 70 19 70	www.samsung.com	QATAR	800-2255 (800-CALL)	www.samsung.com/ae (English) www.samsung.com/ae_ar (Arabic)
FINLAND	030-6227 515	www.samsung.com	EGYPT	08000-726786	www.samsung.com
FRANCE	01 48 63 00 00	www.samsung.com/fr	JORDAN	800-22273 065777444	www.samsung.com/ Levant(English)
GERMANY	0180 6 SAMSUNG bzw. 0180 6 7267864* [HHP] 0180 6 M SAMSUNG bzw. 0180 6 67267864* (*0,20 €/Anruf aus dem dt. Festnetz, aus dem Mobilfunk max. 0,60 €/Anruf)	www.samsung.com	SYRIA	18252273	www.samsung.com/ Levant(English)
CYPRUS	8009 4000 only from landline	www.samsung.com/gr	IRAN	021-8255	www.samsung.com
GREECE	80111-SAMSUNG (80111 726 7864) only from land line (+30) 210 6897691 from mobile and land line	www.samsung.com/gr	MOROCCO	080 100 2255	www.samsung.com
HUNGARY	06-80-SAMSUNG(726-7864)	http://www.samsung.com/hu	SAUDI ARABIA	9200-21230	www.samsung.com/sa (Arabic)
ITALIA	800-SAMSUNG(726-7864) [HHP] 800.Msamsung (800.67267864)	www.samsung.com	TURKEY	444 77 11	www.samsung.com
INDIA	1800 3000 8282 1800 266 8282	www.samsung.com/in	ARGENTINE	0800-333-3733	www.samsung.com.ar
LUXEMBURG	261 03 710	www.samsung.com	URUGUAY	000 405 437 33	www.samsung.com
MONTENEGRO	020 405 888	www.samsung.com	PARAGUAY	009 800 542 0001	www.samsung.com.py
NETHERLANDS	0900-SAMSUNG (0900-7267864) (€ 0,10/Min)	www.samsung.com	BRAZIL	0800-124-421 (Demais cidades e regiões) 4004-0000 (Capitais e grandes centros)	www.samsung.com.br
NORWAY	815 56480	www.samsung.com	CHILE	800-SAMSUNG(726-7864) [HHP] 02-24828200	www.samsung.com/cl
POLAND	0 801-172-678* lub +48 22 607-93-33** [HHP] 0 801-672-678* lub +48 22 607-93-33** *(całkowity koszt połączenia jak za 1 impuls według taryfy operatora) **(koszt połączenia według taryfy operatora)	www.samsung.com/pl	BOLIVIA	800-10-7260	www.samsung.com
PORTUGAL	808 20-SAMSUNG(808 20 7267)	www.samsung.com	COLOMBIA	01-8000 112 112 Bogotá: 6001272	www.samsung.com/co
ROMANIA	08008 SAMSUNG (08008 726 7864) TOLL FREE No.	www.samsung.com/ro	COSTA RICA	0-800-507-7267	www.samsung.com/latin (Spanish) www.samsung.com/latin_en (English)
SERBIA	011 321 6899	www.samsung.com/rs	DOMINICA	1-800-751-2676	www.samsung.com/latin (Spanish) www.samsung.com/latin_en (English)
SLOVAKIA	0800 - SAMSUNG(0800-726 786)	www.samsung.com	ECUADOR	1-800-10-7267	www.samsung.com/latin (Spanish) www.samsung.com/latin_en (English)
SPAIN	902 - 1 - SAMSUNG (902 172 678)	www.samsung.com	EL SALVADOR	800-6225	www.samsung.com/latin (Spanish) www.samsung.com/latin_en (English)
SWEDEN	0771 726 7864 (SAMSUNG)	www.samsung.com	GUATEMALA	1-800-299-0013	www.samsung.com/latin (Spanish) www.samsung.com/latin_en (English)
SWITZERLAND	0848 - SAMSUNG(7267864, CHF 0.08/min)	www.samsung.com/ch (German) www.samsung.com/ch_fr (French)	HONDURAS	800-27919267	www.samsung.com/latin (Spanish) www.samsung.com/latin_en (English)
U.K	0330 SAMSUNG (7267864)	www.samsung.com	JAMAICA	1-800-234-7267	www.samsung.com
EIRE	0818 717100	www.samsung.com	NICARAGUA	00-1800-5077267	www.samsung.com/latin (Spanish) www.samsung.com/latin_en (English)
LITHUANIA	8-800-77777	www.samsung.com/lt	PANAMA	800-7267	www.samsung.com/latin (Spanish) www.samsung.com/latin_en (English)
LATVIA	8000-7267	www.samsung.com/lv	PERU	0-800-777-08 Desde celulares por favor llamar al número 336 8686	www.samsung.com/pe
ESTONIA	800-7267	www.samsung.com/ee	PUERTO RICO	1-800-682-3180	www.samsung.com
RUSSIA	8-800-555-55-55	www.samsung.com	TRINIDAD & TOBAGO	1-800-SAMSUNG(726-7864)	www.samsung.com
GEORGIA	0-800-555-555	www.samsung.com	VENEZUELA	0-800-100-5303	www.samsung.com/ve
ARMENIA	0-800-05-555	www.samsung.com	AUSTRALIA	1300 362 603	www.samsung.com/au
AZERBAIJAN	088-55-55-555	www.samsung.com		1-800-10-7267864 [PLDT]	
KAZAKHSTAN	8-10-800-500-55-500(GSM: 7799)	www.samsung.com	PHILIPPINES	1-800-8-7267864 [Globe landline and Mobile] 02-4222111 [Other landline]	www.samsung.com/ph
UZBEKISTAN	8-10-800-500-55-500	www.samsung.com	SINGAPORE	1800-SAMSUNG(726-7864)	www.samsung.com/sg
KYRGYZSTAN	00-800-500-55-500	www.samsung.com			
TADJIKISTAN	8-10-800-500-55-500	www.samsung.com			
MONGOLIA	+7-800-555-55-55	www.samsung.com			
BELARUS	810-800-500-55-500	www.samsung.com			

**AEEE Yönetmeliğine Uygundur**  
**This product is ROHS compliant**



## Duct Type Series

Slim duct : MH\*\*\*FEEA

NJ\*\*\*LHXEA

MA duct : MH\*\*\*FUEA

# Air Conditioner user manual

**Planet  
First** 100%  
Recycled Paper

This manual is made with 100% recycled paper.

imagine the possibilities

Thank you for purchasing this Samsung product.



DB98-31997A-05

**SAMSUNG**