

HT-C330

Digital Home Cinema System user manual

Imagine the possibilities

Thank you for purchasing this Samsung product.

To receive more complete service,
please register your product at



www.samsung.com/register

SAMSUNG

Safety Information

Safety Warnings

TO REDUCE THE RISK OF ELECTRIC SHOCK, DO NOT REMOVE THE COVER(OR BACK).
NO USER-SERVICEABLE PARTS ARE INSIDE. REFER SERVICING TO QUALIFIED SERVICE PERSONNEL.

| | | |
|---|--|---|
|  | CAUTION RISK OF ELECTRIC SHOCK DO NOT OPEN |  |
| This symbol indicates "dangerous voltage" inside the product that presents a risk of electric shock or personal injury. | CAUTION : TO PREVENT ELECTRIC SHOCK, MATCH WIDE BLADE OF PLUG TO WIDE SLOT, FULLY INSERT. | This symbol indicates important instructions accompanying the product. |

WARNING

- To reduce the risk of fire or electric shock, do not expose this appliance to rain or moisture.

CAUTION

- Apparatus shall not be exposed to dripping or splashing and no objects filled with liquids, such as vases, shall be placed on the apparatus.
- The Mains plug is used as a disconnect device and shall stay readily operable at any time.
- This apparatus shall always be connected to a AC outlet with a protective grounding connection.
- To disconnect the apparatus from the mains, the plug must be pulled out from the mains socket, therefore the mains plug shall be readily operable.

CLASS 1 **LASER PRODUCT**
KLASSE 1 **LASER PRODUKT**
LUOKAN 1 **LASER LAITE**
KLASS 1 **LASER APPARAT**
PRODUCTO **LÁSER CLASE 1**

CLASS 1 LASER PRODUCT

This Compact Disc player is classified as a CLASS 1 LASER product.

Use of controls, adjustments or performance of procedures other than those specified herein may result in hazardous radiation exposure.

CAUTION

- INVISIBLE LASER RADIATION WHEN OPEN AND INTERLOCKS DEFEATED, AVOID EXPOSURE TO BEAM.

Wiring the Main Power Supply Plug (UK Only)

IMPORTANT NOTICE

The mains lead on this equipment is supplied with a moulded plug incorporating a fuse. The value of the fuse is indicated on the pin face of the plug and if it requires replacing, a fuse approved to BS1362 of the same rating must be used. Never use the plug with the fuse cover removed. If the cover is detachable and a replacement is required, it must be of the same colour as the fuse fitted in the plug. Replacement covers are available from your dealer. If the fitted plug is not suitable for the power points in your house or the cable is not long enough to reach a power point, you should obtain a suitable safety approved extension lead or consult your dealer for assistance. However, if there is no alternative to cutting off the plug, remove the fuse and then safely dispose of the plug. Do not connect the plug to a mains socket as there is a risk of shock hazard from the bared flexible cord. Never attempt to insert bare wires directly into a mains socket. A plug and fuse must be used at all times.

IMPORTANT

The wires in the mains lead are coloured in accordance with the following code:- BLUE = NEUTRAL BROWN = LIVE As these colours may not correspond to the coloured markings identifying the terminals in your plug, proceed as follows:-The wire coloured BLUE must be connected to the terminal marked with the letter N or coloured BLUE or BLACK. The wire coloured BROWN must be connected to the terminal marked with the letter L or coloured BROWN or RED.

WARNING : DO NOT CONNECT EITHER WIRE TO THE EARTH TERMINAL WHICH IS MARKED WITH LETTER E OR BY THE EARTH SYMBOL , OR COLOURED GREEN OR GREEN AND YELLOW.

Precautions

- Ensure that the AC power supply in your house complies with the identification sticker located on the back of your product.
- Install your product horizontally, on a suitable base (furniture), with enough space around it for ventilation (7.5–10cm).
- Do not place the product on amplifiers or other equipment which may become hot. Make sure the ventilation slots are not covered.
- Do not stack anything on top of the product.
- Before moving the product, ensure the Disc Insert Hole is empty.
- In order to disconnect the product completely from the power supply, remove the AC plug from the wall outlet, especially when left unused for a long period of time.
- During thunderstorms, disconnect the AC plug from the wall outlet. Voltage peaks due to lightning could damage the product.
- Do not expose the product to direct sunlight or other heat sources. This could lead to overheating and malfunction of the product.
- Protect the product from moisture, and excess heat or equipment creating strong magnetic or electric fields (i.e. speakers.).
- Disconnect the power cable from the AC supply if the product malfunctions.
- Your product is not intended for industrial use. Use of this product is for personal use only.
- Condensation may occur if your product or disc has been stored in cold temperatures. If transporting the product during the winter, wait approximately 2 hours until the product has reached room temperature before using.
- The batteries used with this product contain chemicals that are harmful to the environment. Do not dispose of batteries in the general household trash.

Accessories

Check for the supplied accessories below.



Video Cable



FM Antenna



User's Manual



Remote Control/Batteries
(AAA size)



Scart Adapter
(Europe only)

Safety Information

Cautions on Handling and Storing Discs

Small scratches on the disc may reduce sound and picture quality or cause skipping.

Be especially careful not to scratch discs when handling them.

Holding discs

- Do not touch the playback side of the disc.
- Hold the disc by the edges so that fingerprints will not get on the surface.
- Do not stick paper or tape on the disc.



Disc Storage

- Do not keep in direct sunlight
- Keep in a cool ventilated area
- Keep in a clean Protection jacket.
Store vertically.



NOTE

- Do not allow the discs to become contaminated with dirt.
- Do not load cracked or scratched discs.

Handling and Storing Discs

If you get fingerprints or dirt on the disc, clean it with a mild detergent diluted in water and wipe with a soft cloth.

- When cleaning, wipe gently from the inside to the outside of the disc



NOTE

- Condensation may form if warm air comes into contact with cold parts inside the product. When condensation forms inside the product, it may not operate correctly. If this occurs, remove the disc and let the product stand for 1 or 2 hours with the power on.

Licence

- ABOUT DIVX VIDEO: DivX® is a digital video format created by DivX, Inc. This is an official DivX Certified device that plays DivX video. Visit www.divx.com for more information and software tools to convert your files into DivX video.
- 
- ABOUT DIVX VIDEO-ON-DEMAND: This DivX Certified® device must be registered in order to play DivX Video-on-Demand (VOD) content. To generate the registration code, locate the DivX VOD section in the device setup menu. Go to vod.divx.com with this code to complete the registration process and learn more about DivX VOD.
 - DivX Certified® to play DivX © video
 - Dolby and the double-D symbol are registered trademarks of Dolby Laboratories.
 - "Pat. 7,295,673; 7,460,688; 7,519,274"

Copyright

© 2010 Samsung Electronics Co., Ltd. All rights reserved.

Copy Protection

- Many DVD discs are encoded with copy protection. Because of this, you should only connect your product directly to your TV, not to a VCR. Connecting to a VCR results in a distorted picture from copy-protected DVD discs.
- "This item incorporates copy protection technology that is protected by U.S. patents and other intellectual property rights of Rovi Corporation. Reverse engineering and disassembly are prohibited."

Contents

SAFETY INFORMATION

2

- 2 Safety Warnings
- 3 Precautions
- 3 Accessories
- 4 Cautions on Handling and Storing Discs
- 4 Licence
- 4 Copyright
- 4 Copy Protection

GETTING STARTED

7

- 7 Icons that will be used in manual
- 7 Disc Types and Characteristics
- 11 Description
- 11 Front Panel
- 12 Rear Panel
- 13 Remote control

CONNECTIONS

15

- 15 Connecting the Speakers
- 17 Connecting the Video Out to your TV
- 19 Connecting the FM Antenna
- 20 Connecting Audio from External Components

SETUP

21

- 21 Before Starting (Initial Setting)
- 21 Setting the Setup menu
- 22 Display
 - 22 TV Aspect
- 22 Audio
 - 22 Speaker Setting
 - 24 DRC (Dynamic Range Compression)
 - 24 AV-SYNC
 - 24 EQ Optimizer
- 24 System
 - 24 Initial Setting
 - 24 DivX(R) Registration
- 25 Language
- 25 Security
 - 25 Parental Rating
 - 25 Change Password
- 25 Support
 - 25 Product Information

ENGLISH

Contents

BASIC FUNCTIONS

26

- 26 Disc Playback
- 26 Audio CD(CD-DA)/MP3/WMA Playback
- 27 JPEG File Playback
- 27 Using the Playback Function
- 32 Sound Mode
- 33 Listening to Radio

ADVANCED FUNCTIONS

34

- 34 USB Function
- 34 CD Ripping

OTHER INFORMATION

35









- 35 Troubleshooting
- 36 Language code list
- 37 Specifications

- Figures and illustrations in this User Manual are provided for reference only and may differ from actual product appearance.
- An administration fee may be charged if either
 - a. an engineer is called out at your request and there is no defect in the product (i.e. where you have failed to read this user manual)
 - b. you bring the unit to a repair centre and there is no defect in the product (i.e. where you have failed to read this user manual).
- The amount of such administration charge will be advised to you before any work or home visit is carried out.

Getting Started

Icons that will be used in manual

Make sure to check the following terms before reading the user manual.

| Icon | Term | Definition |
|---|--------------|---|
|  | DVD | This involves a function available with DVD-Video or DVD±R/±RW discs that have been recorded and finalised in Video Mode. |
|  | CD | This involves a function available with a data CD (CD DA, CD-R/-RW). |
|  | MP3 | This involves a function available with CD-R/-RW discs. |
|  | JPEG | This involves a function available with CD-R/-RW discs. |
|  | DivX | This involves a function available with MPEG4 discs. (DVD±R/±RW, CD-R/-RW) |
|  | CAUTION | This involves a case where a function does not operate or settings may be cancelled. |
|  | NOTE | This involves tips or instructions on the page that help each function operate. |
|  | Shortcut Key | This function provides direct and easy access pressing the button on the remote control. |

Disc Types and Characteristics

Region Code

The product and the discs are coded by region. These regional codes must match in order for the disc to play. If the codes do not match, the disc will not play.

| Disc Type | Region Code | Area |
|-----------|---|--|
| DVD-VIDEO |  | The U.S., U.S. territories and Canada |
| |  | Europe, Japan, the Middle East, Egypt, South Africa, Greenland |
| |  | Taiwan, Korea, the Philippines, Indonesia, Hong Kong |
| |  | Mexico, South America, Central America, Australia, New Zealand, Pacific Islands, Caribbean |
| |  | Russia, Eastern Europe, India, most of Africa, North Korea, Mongolia |
| |  | China |

Getting Started

Disc types that can be played

| Disc Types & Mark (Logo) | Recorded Signals | Disc Size | Max. Playing Time |
|--|---------------------|-----------|------------------------------------|
|  DVD-VIDEO | AUDIO + VIDEO | 12 cm | Approx. 240 min. (single-sided) |
| | | | Approx. 480 min. (double-sided) |
| | | 8 cm | Approx. 80 min. (single-sided) |
| | | | Approx. 160 min. (double-sided) |
|  AUDIO-CD | AUDIO | 12 cm | 74 min. |
| | | 8 cm | 20 min. |
|  DivX | AUDIO + VIDEO | 12 cm | — |
| | | 8 cm | — |

Do not use the following type of discs!

- LD, CD-G, CD-I, CD-ROM, DVD-ROM and DVD-RAM discs cannot be played on this product. If such discs are played, a <WRONG DISC FORMAT> message appears on the TV screen.
- DVD discs purchased abroad may not play on this product. If such discs are played, a <Wrong Region. Please check Disc.> message appears on the TV screen.

Disc Types And Disc Format

This product does not support Secure (DRM) Media files.

CD-R Discs

- Some CD-R discs may not be playable depending on the disc recording device (CD-Recorder or PC) and the condition of the disc.
- Use a 650MB/74 minute CD-R disc. Do not use CD-R discs over 700MB/80 minutes as they may not be played back.
- Some CD-RW (Rewritable) media, may not be playable.
- Only CD-Rs that are properly "closed" can be fully played. If the session is closed but the disc is left open, you may not be able to fully play the disc.

CD-R MP3 Discs

- Only CD-R discs with MP3 files in ISO 9660 or Joliet format can be played.
- MP3 file names should contain no blank spaces or special characters (. / = +).
- Use discs recorded with a compression/ decompression data rate greater than 128Kbps.
- Only files with the ".mp3" and ".MP3" extensions can be played.
- Only a consecutively written multisession disc can be played. If there is a blank segment in the Multisession disc, the disc can be played only up to the blank segment.
- If the disc is not closed, it will take longer to begin playback and not all of the recorded files may be played.
- For files encoded in Variable Bit Rate (VBR) format, i.e. files encoded in both low bit rate and high bit rate (e.g., 32Kbps ~ 320Kbps), the sound may skip during playback.
- A maximum of 500 tracks can be played per CD.
- A maximum of 300 folders can be played per CD.

CD-R JPEG Discs

- Only files with the ".jpg" extensions can be played.
- If the disc is not closed, it will take longer to start playing and not all of the recorded files may be played.
- Only CD-R discs with JPEG files in ISO 9660 or Joliet format can be played.
- JPEG file names should be 8 characters or less in length and contain no blank spaces or special characters (. / = +).
- Only a consecutively written multisession disc can be played. If there is a blank segment in the multisession disc, the disc can be played only up to the blank segment.
- A maximum of 999 images can be stored on a folder.
- When playing a Kodak/Fuji Picture CD, only the JPEG files in the picture folder can be played.
- Picture discs other than Kodak/Fuji Picture CDs may take longer to start playing or may not play at all.

DVD±R/±RW, CD-R/RW Discs

- Software updates for incompatible formats are not supported.
(Example : QPEL, GMC, resolutions higher than 800 x 600 pixels, etc.)
- If a DVD-R/-RW disc has not been recorded properly in DVD Video format, it will not be playable.

- Since this product only provides encoding formats authorized by DivX Networks, Inc., a DivX file created by the user might not play.

DivX (Digital internet video express)

DivX is a video file format developed by Microsoft and is based on MPEG4 compression technology to provide audio and video data over the Internet in real-time.

MPEG4 is used for video encoding and MP3 for audio encoding, enabling to watch a movie at near DVD-quality video and audio.

Supported Formats (DivX)

This product only supports the following media formats. If both video and audio formats are not supported, the user may experience problems such as broken images or no sound.

Supported Video Formats

| Format | Supported Versions |
|--------|------------------------|
| AVI | DivX3.11~DivX5.1, XviD |
| WMV | V1/V2/V3/V7 |

Supported Audio Formats

| Format | Bit Rate | Sampling Frequency |
|--------|-------------|--------------------|
| MP3 | 80~320kbps | 44.1khz |
| WMA | 56~128kbps | |
| AC3 | 128~384kbps | 44.1/48khz |

- Aspect Ratio : Although the default DivX resolution is 640x480 pixels, this product supports up to 720x480 pixels. TV screen resolutions higher than 800 will not be supported.
- When you play a disc whose sampling frequency is higher than 48khz or 320kbps, you may experience shaking on the screen during playback.
- Sections with a high frame rate might not be played while playing a DivX file.

Getting Started

Notes on USB connection

Supported devices: USB storage media, MP3 player, digital camera, USB card reader

- 1) If a folder or file name is longer than 10 characters, it may not properly display or operate.
- 2) A subtitle file bigger than 148KB may not be properly displayed.
- 3) A certain USB/digital camera device, USB card reader may not be compatible with the product.
- 4) FAT16 and FAT32 file systems are supported.
 - NTFS file system is not supported.
- 5) Photo (JPEG), music (MP3, WMA) and video file should have their names in Korean or English. Otherwise, the file may not played.
- 6) Connect directly to the product's USB port. Connecting through another cable may raise problems with USB compatibility.
- 7) Inserting more than one memory device to a multi-card reader may not operate properly.
- 8) PTP protocol for digital camera is not supported.
- 9) Do not disconnect USB device during a "Reading" process.
- 10) Bigger the image resolution, the longer the delay to displaying.
- 11) DRM applied MP3/WMA or video files downloaded from a commercial site are not played back.
- 12) External HDD device is not supported.
- 13) Supported file formats

| Format | Still Picture | Music | | Movie | |
|--------------------|---------------|-------------|----------------|-----------------|-------------------------------|
| | | File name | File extension | Bit rate | Version |
| File name | JPG | MP3 | WMA | WMV | DivX |
| File extension | JPG .JPEG | .MP3 | .WMA | .WMV | .AVI |
| Bit rate | - | 80~320 kbps | 56~128 kbps | 4Mbps | 4Mbps |
| Version | - | - | V8 | V1,V2, V3,V7 | DivX3.11~ DivX5.1, XviD |
| Pixel | 640x480 | - | - | 720x480 | |
| Sampling Frequency | - | 44.1kHz | 44.1kHz | 44.1KHz~ 48KHz | |

Description

Front Panel

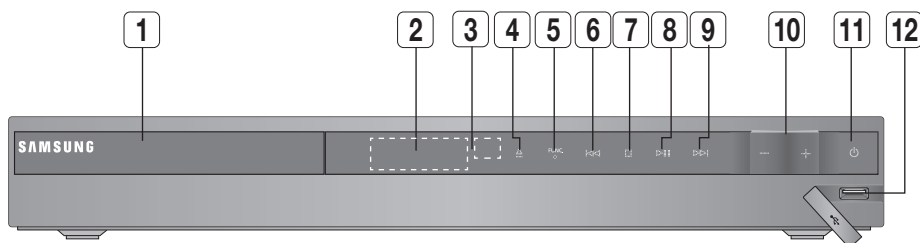

| | | |
|-----------|---|---|
| 1 | DISC TRAY | Insert disc here. |
| 2 | DISPLAY | Displays the playing status, time, etc. |
| 3 | REMOTE CONTROL SENSOR | Detects signals from the remote control. |
| 4 | OPEN/CLOSE BUTTON (▲) | Opens and closes the disc tray. |
| 5 | FUNCTION BUTTON (FUNC. ◆) | The mode switches as follows : DVD/CD → D.IN → AUX → USB → FM. |
| 6 | TUNING DOWN & SKIP BUTTON (◀▶) | Goes back to the previous title/chapter/track. Tunes down the FM frequency band. |
| 7 | STOP BUTTON (■) | Stops disc playback. |
| 8 | PLAY/PAUSE BUTTON (▶) | Plays a disc or pauses playback. |
| 9 | TUNING UP & SKIP BUTTON (▶▶) | Goes to the next title/chapter/track. Tunes up the FM frequency band. |
| 10 | VOLUME CONTROL BUTTON (—, +) | Volume adjustment. |
| 11 | POWER BUTTON (⏻) | Turns the product on and off. |
| 12 | USB PORT | Connect here and play files from external USB storage devices such as MP3 players, USB flash memory, etc. |

Getting Started

Rear Panel

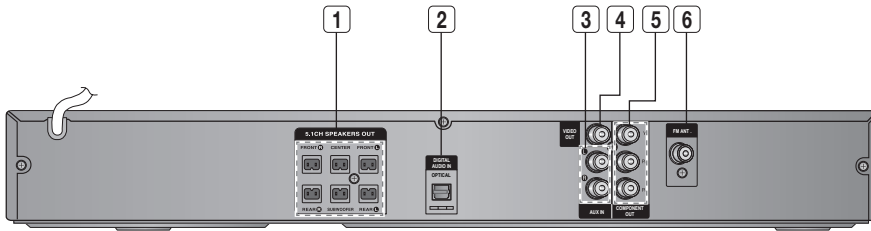

| | | |
|----------|--|---|
| 1 | 5.1 CHANNEL SPEAKER OUTPUT CONNECTORS | Connect the front, Centre, surround speakers and subwoofer. |
| 2 | EXTERNAL DIGITAL OPTICAL IN JACK (DIGITAL AUDIO IN) | Use this to connect external equipment capable of digital output. |
| 3 | AUX IN JACKS | Connect to the 2CH Analogue output of an external device (such as a VCR). |
| 4 | VIDEO OUT JACK | Connect your TV's Video Input jack (VIDEO IN) to the VIDEO OUT jack. |
| 5 | COMPONENT VIDEO OUTPUT JACKS | Connect a TV with Component video inputs to these jacks. |
| 6 | FM ANTENNA JACK | Connect the FM antenna. |

Remote control

Tour of the Remote Control

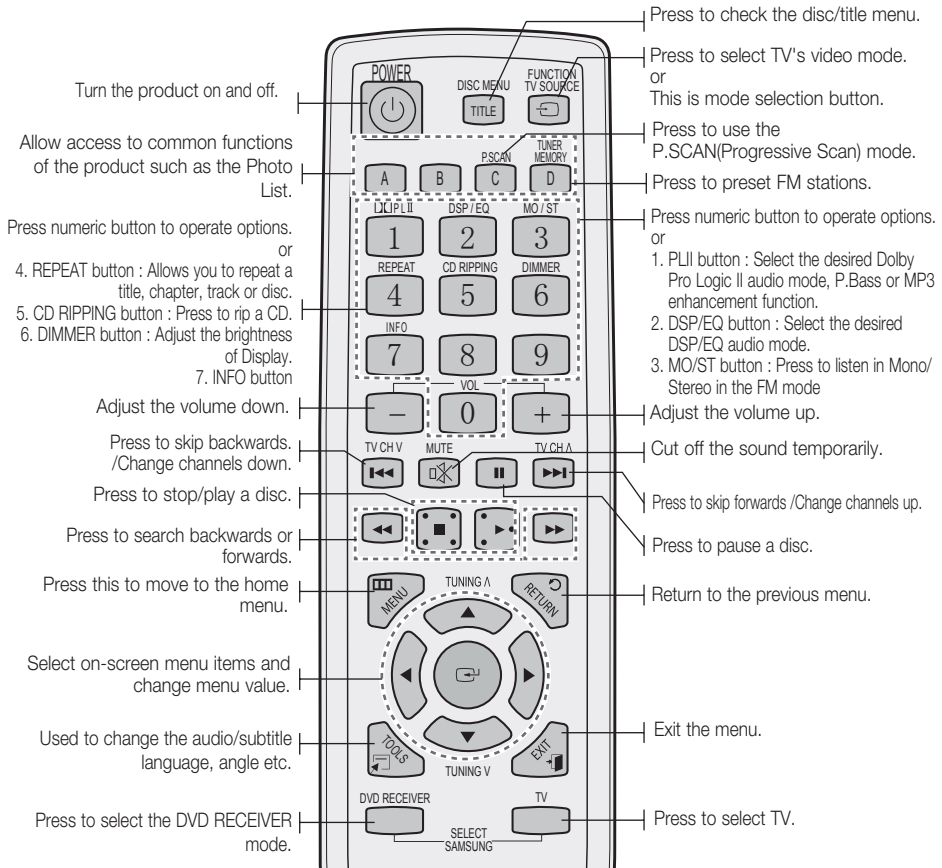

Installing batteries in the Remote Control

* Battery size: AAA

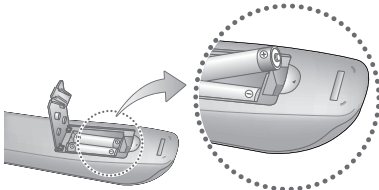

NOTE

- Place batteries in the remote control so they match the polarity : (+) to (+) and (-) to (-).
- Always replace both batteries at the same time.
- Do not expose the batteries to heat or flame.
- The remote control can be used up to approximately 7 meters in a straight line.

Getting Started

Setting the Remote Control

You can control certain functions of your TV with this remote control.

When operating a TV with the remote control

1. Press the **TV** button to set the remote control to TV mode.
2. Press the **POWER** button to turn on the TV.
3. While holding down the **POWER** button, enter the code corresponding to your brand of TV.
 - If there is more than one code listed for your TV in the table, enter one at a time to determine which code works.
 - **Example : For a Samsung TV**
While holding down the **POWER** button, use the number buttons to enter 00, 15, 16, 17 and 40.
4. If the TV turns off, the setting is complete.
 - You can use the TV **POWER**, **VOLUME**, **CHANNEL**, and **Numeric** buttons (0-9).

NOTE

- The remote control may not work or some operations may not be possible with some brands of TVs.
- The remote control will work on a Samsung TV by default.

TV Brand Code List

| Brand | Code | Brand | Code |
|-------------------------|--|--------------------------|--|
| Admiral (M.Wards) | 56, 57, 58 | MTC | 18 |
| A Mark | 01, 15 | NEC | 18, 19, 20, 40, 59, 60 |
| Anam | 01, 02, 03, 04, 05, 06, 07, 08, 09, 10, 11, 12, 13, 14 | Nikei | 03 |
| AOC | 01, 18, 40, 48 | Onking | 03 |
| Bell & Howell (M.Wards) | 57, 58, 81 | Onwa | 03 |
| Broscasonic | 59, 60 | Panasonic | 06, 07, 08, 09, 54, 66, 67, 73, 74 |
| Candle | 18 | Penney | 18 |
| Cetronic | 03 | Philco | 03, 15, 17, 18, 48, 54, 59, 62, 69, 90 |
| Citizen | 03, 18, 25 | Philips | 15, 17, 18, 40, 48, 54, 62, 72 |
| Cinema | 97 | Pioneer | 63, 66, 80, 91 |
| Classic | 03 | Portland | 15, 18, 59 |
| Concerto | 18 | Proton | 40 |
| Contec | 46 | Quasar | 06, 66, 67 |
| Coronado | 15 | Radio Shack | 17, 48, 56, 60, 61, 75 |
| Craig | 03, 05, 61, 82, 83, 84 | RCA/Proscan | 18, 59, 67, 76, 77, 78, 92, 93, 94 |
| Croslex | 62 | Realistic | 03, 19 |
| Crown | 03 | Sampo | 40 |
| Curtis Mates | 59, 61, 63 | Samsung | 00, 15, 16, 17, 40, 43, 46, 47, 48, 49 |
| CXC | 03 | Sanyo | 19, 61, 65 |
| Daewoo | 02, 03, 04, 15, 16, 17, 18, 19, 20, 21, 22, 23, 24, 25, 26, 27, 28, 29, 30, 32, 34, 35, 36, 48, 59, 90 | Scott | 03, 40, 60, 61 |
| Daytron | 40 | Sears | 15, 18, 19 |
| Dynasty | 03 | Sharp | 15, 57, 64 |
| Emerson | 03, 15, 40, 46, 59, 61, 64, 82, 83, 84, 85 | Signature 2000 (M.Wards) | 57, 58 |
| Fisher | 19, 65 | Sony | 50, 51, 52, 53, 55 |
| Funai | 03 | Soundesign | 03, 40 |
| Futuretech | 03 | Spectricon | 01 |
| General Electric (GE) | 06, 40, 56, 59, 66, 67, 68 | SSS | 18 |
| Hall Mark | 40 | Sylvania | 18, 40, 48, 54, 59, 60, 62 |
| Hitachi | 15, 18, 50, 59, 69 | Symphonic | 61, 95, 96 |
| Inkel | 45 | Tatung | 06 |
| JC Penny | 56, 59, 67, 86 | Techwood | 18 |
| JVC | 70 | Teknika | 03, 15, 18, 25 |
| KTV | 59, 61, 87, 88 | TMK | 18, 40 |
| KEC | 03, 15, 40 | Toshiba | 19, 57, 63, 71 |
| KMC | 15 | Vidtech | 18 |
| LG (Goldstar) | 01, 15, 16, 17, 37, 38, 39, 40, 41, 42, 43, 44 | Vidtech | 59, 60, 69 |
| Luxman | 18 | Wards | 15, 17, 18, 40, 48, 54, 60, 64 |
| LXI (Sears) | 19, 54, 56, 59, 60, 62, 63, 65, 71 | Yamaha | 18 |
| Magnavox | 15, 17, 18, 48, 54, 59, 60, 62, 72, 89 | York | 40 |
| Marantz | 40, 54 | Yupiteru | 03 |
| Matsui | 54 | Zenith | 58, 79 |
| MGA | 18, 40 | Zonda | 01 |
| Mitsubishi/MGA | 18, 40, 59, 60, 75 | Dongyang | 03, 54 |

Connections

This section involves various methods of connecting the product to other external components. Before moving or installing the product, be sure to turn off the power and disconnect the power cord.

Connecting the Speakers

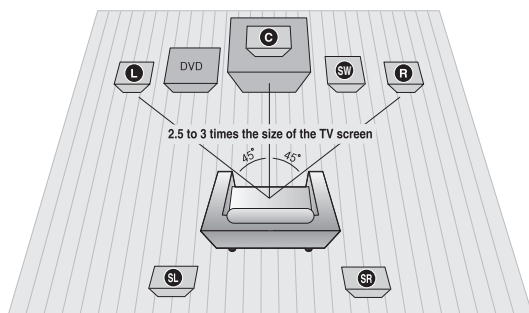

Position of the product

Place it on a stand or cabinet shelf, or under the TV stand.

Selecting the Listening Position

The listening position should be located about 2.5 to 3 times the distance of the TV's screen size away from the TV.

Example : For 32" TV's 2~2.4m
For 55" TV's 3.5~4m

| | |
|----------------------------|---|
| Front Speakers L R | Place these speakers in front of your listening position, facing inwards (about 45°) toward you. Place the speakers so that their tweeters will be at the same height as your ear. Align the front face of the front speakers with the front face of the centre speaker or place them slightly in front of the centre speakers. |
| Centre Speaker C | It is best to install it at the same height as the front speakers. You can also install it directly over or under the TV. |
| Rear Speakers SL SR | Place these speakers to the side of your listening position. If there isn't enough room, place these speakers so they face each other. Place them about 60 to 90cm above your ear, facing slightly downward. * Unlike the front and centre speakers, the rear speakers are used to handle mainly sound effects and sound will not come from them all the time. |
| Subwoofer SW | The position of the subwoofer is not so critical. Place it anywhere you like. |

! CAUTION

- Do not let children play with or near the speakers. They could get hurt if the speaker falls.
- When connecting the speaker wires to the speakers, make sure that the polarity (+/-) is correct.
- Keep the subwoofer out of the reach of children so as to prevent them from inserting their hands or alien substances into the duct (hole) of the subwoofer.
- Do not hang the subwoofer on the wall through the duct (hole).

📌 NOTE

- If you place a speaker near your TV set, screen colour may be distorted because of the magnetic field generated by the speaker. If this occurs, place the speaker away from your TV set.

Connections

Connecting the Speakers

Speaker Components

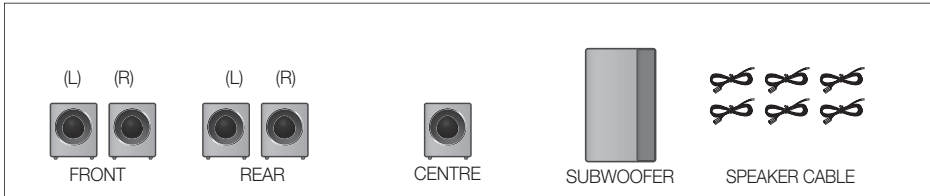

Connecting The Speakers

1. Press down the terminal tab on the back of the speaker.
2. Insert the black wire into the black terminal (-) and the red wire into the red terminal (+), and then release the tab.
3. Connect the connecting plugs to the back of the product by matching the colours of the speaker plugs to the speaker jacks.

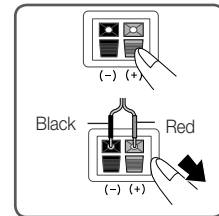

HT-C330

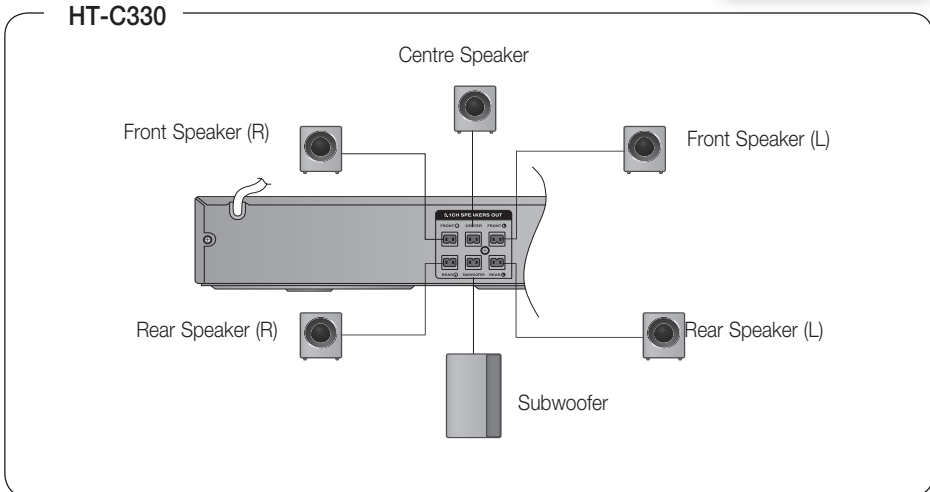

Connecting the Video Out to your TV

Choose one of the three methods for connecting to a TV.

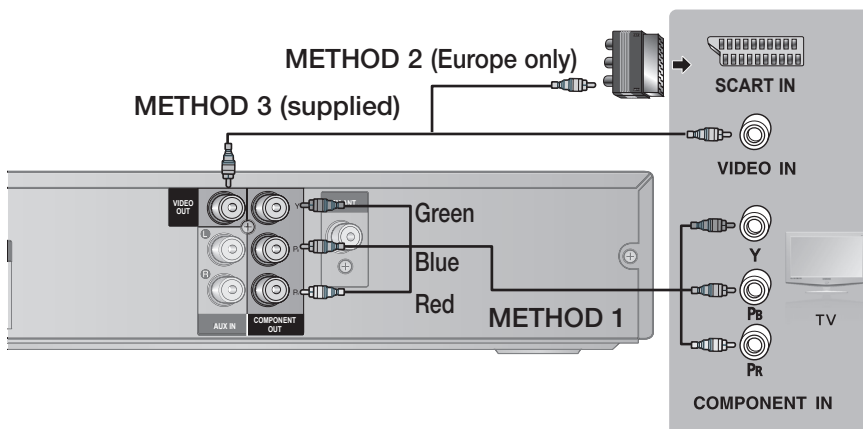

METHOD 1 : Component (Progressive Scan) Video

If your television is equipped with Component Video inputs, connect a Component video cable(not supplied) from the **COMPONENT OUT** (Pr, Pb and Y) jacks on the back of the product to the Component Video Input jacks on your TV.

METHOD 2 : Scart (Europe only)

If your television is equipped with a SCART input, connect the supplied video cable from the **VIDEO OUT** jack on the back of the product to the VIDEO jack on the Scart adapter (Europe only), then connect the SCART adapter's jack to the SCART IN jack on your television.

METHOD 3 : Composite Video

Connect the supplied Video cable from the **VIDEO OUT** jack on the back of the product to the VIDEO IN jack on your TV.

NOTE

- When the Progressive scan mode is selected, the VIDEO output does not feed any signals.
- This product operates in Interlace scan mode 480i(576i) for component/composite output.
- After making the video connection, set the Video input source on your TV to match the corresponding Video output mode on your product.

Turn this product on first before you set the video input source on your TV. See your TV owner's manual for more information on how to select the TV's Video Input source.

! CAUTION

- Do not connect the unit through a VCR. Video signals fed through VCRs may be affected by copyright protection systems and the picture will be distorted on the television.

Connecting the Video Out to your TV



P.SCAN(PROGRESSIVE SCAN) FUNCTION

Unlike regular Interlace Scan, in which two fields of picture information alternate to create the entire picture (odd scan lines, then even scan lines), Progressive Scan uses one field of information (all lines displayed in one pass) to create a clear and detailed picture without visible scan lines.

1. Press **STOP** button.
 - If playing a disc, press the **STOP** button twice so that "STOP", appears on the display.
2. Press and hold **P.SCAN** button on the remote control for over 5 seconds.
 - Pressing and holding the button for over 5 seconds will select "P.SCAN" and "I.SCAN" alternately.
 - When you select P.SCAN, "P.SCAN" will appear on the display.
 - To set P.Scan mode for DivX discs, press the **P.SCAN** button on the remote control for more than 5 seconds with no disc in the unit ("NO DISC" on the display), then load the DivX disc and play.



What is Progressive (or Non-Interlaced) Scanning?

| Interlaced Scan (1 FRAME = 2 FIELDS) | Progressive Scan (FULL FRAME) |
|---|--|
| <div style="text-align: center;">  </div> <p>In interlaced-scan video, a frame consists of two interlaced fields (odd and even), where each field contains every other horizontal line in the frame.</p> <p>The odd field of alternating lines is displayed first, and then the even field is displayed to fill in the alternating gaps left by the odd field to form a single frame.</p> <p>One frame, displayed every 1/30th of a second, contains two interlaced fields, thus a total of 60 fields are displayed every one second.</p> <p>The interlaced scanning method is intended for capturing a still object.</p> | <div style="text-align: center;">  </div> <p>The progressive scanning method scans one full frame of video consecutively down the screen, line by line. An entire image is drawn at one time, as opposed to the interlaced scanning process by which a video image is drawn in a series of passes. The progressive scanning method is desirable for dealing with moving objects.</p> |

NOTE

- Depending on the capabilities of your TV, this function may not work.

Connecting the FM Antenna

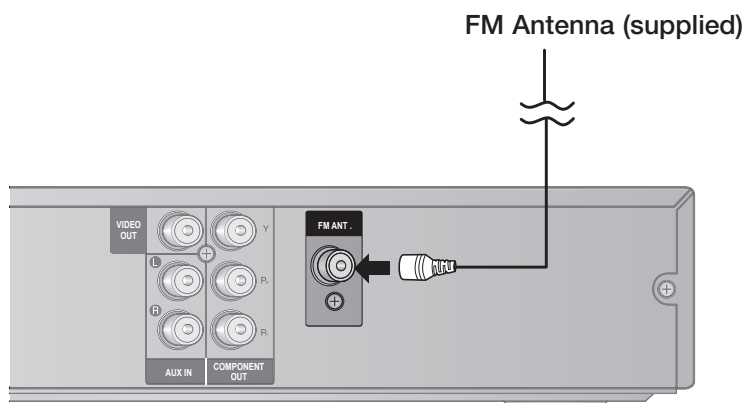

1. Connect the FM antenna supplied to the FM Antenna jack.
2. Slowly move the antenna wire around until you find a location where reception is good, then fasten it to a wall or other rigid surface.

 **NOTE**

- This product does not receive AM broadcasts.

Connections

Connecting Audio from External Components

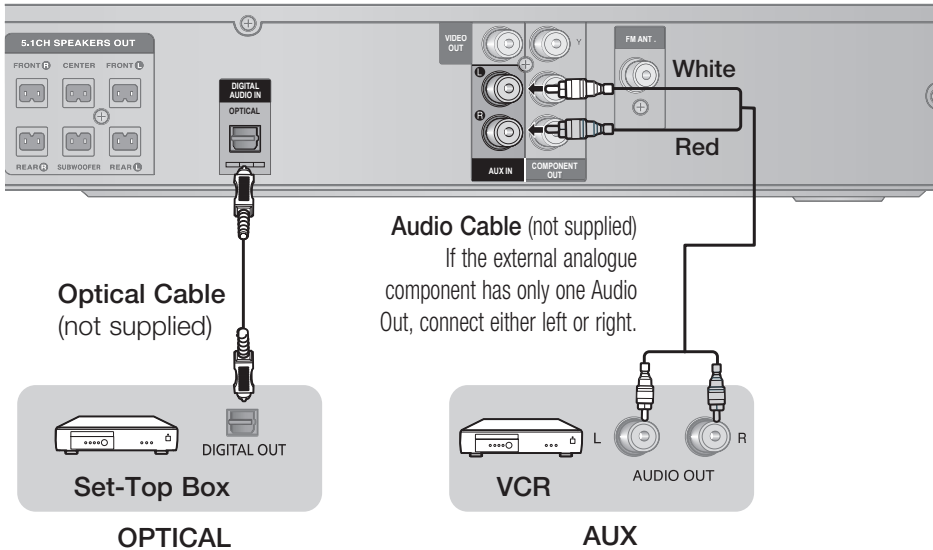

AUX : Connecting an External Analogue Component

Analogue signal components such as a VCR.

1. Connect **AUX IN** (Audio) on the back of the product to the Audio Out of the external Analogue component.
 - Be sure to match the colours of the connecting jacks.
2. Press the **FUNCTION** button to select **AUX** input.
 - The mode switches as follows :
DVD/CD → D.IN → AUX → USB → FM.

NOTE

- You can connect the Video Output jack of your VCR to the TV, and connect the Audio Output jacks of the VCR to this product.

OPTICAL : Connecting an External Digital Component

Digital signal components such as a Cable Box/Satellite receiver (Set-Top Box).

1. Connect the **DIGITAL AUDIO IN (OPTICAL)** on the back of the product to the Digital Output of the external digital component.
2. Press the **FUNCTION** button to select **D.IN**.
 - The mode switches as follows :
DVD/CD → D.IN → AUX → USB → FM.

Before Starting (Initial Setting)

1. Press the **POWER** button when it is plugged in TV for the first time.
Initial Setting screen will be displayed.

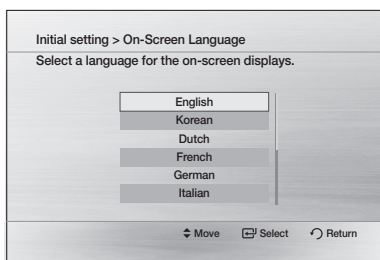

2. Press the **▲▼** buttons to select the desired language, then press the **ENTER** button.
3. Press the **ENTER** button to select Start button.
4. Press the **▲▼** buttons to select desired TV Aspect, then press the **ENTER** button.
5. Press the **ENTER** button to select Start button.



NOTE

- If you want to move to the previous screen, press the **RETURN** button.
- Once you select a menu language, you can change it by pressing the **STOP** (■) button on the remote control for more than 5 seconds with no disc inserted.
- When the Initial Setting screen does not appear, refer to the Initial Setting. (see page 24)

Selecting the Video Format

Each country has a different video format standard. You can select the video format either NTSC or PAL. Press and hold the Number 7 button on the remote control for over 5 seconds while the product is turned off.

- "NTSC" or "PAL" will appear on the display. At this time, press the Number 7 button to select either "NTSC" or "PAL".
- The video format of the disc must be the same as the video format of your TV.

Setting the Setup menu

The access step may differ depending on the selected menu. The GUI (Graphical User Interface) in this manual may differ, depending on the firmware version.

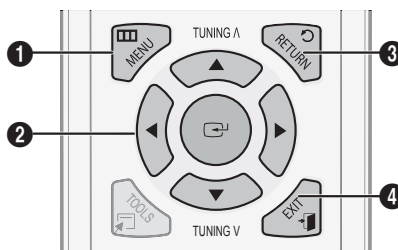

- 1 **MENU BUTTON** : Display the home menu.

ENTER / DIRECTION BUTTON

- 2 Move the cursor and select an item.
Select the currently selected item.
Confirm the setting.

- 3 **RETURN BUTTON** : Return to the previous setup menu.

- 4 **EXIT BUTTON** : Exit the setup menu.

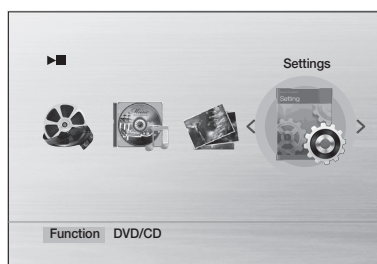

1. Press the **POWER** button.
2. Press the **◀▶** buttons to select **Settings**, then press the **ENTER** button.
3. Press the **▲▼** buttons to select the desired menu, then press the **ENTER** button.
4. Press the **▲▼** buttons to select the desired sub-menu, then press the **ENTER** button.
5. Press the **▲▼** buttons to select the desired item, then press the **ENTER** button.
6. Press the **EXIT** button to exit the setup menu.

Setup

Display

You can configure various display options such as the TV Aspect, Resolution, etc.

TV Aspect

Depending on the type of television you have, you may want to adjust the screen setting.

• 4:3 Pan-Scan



Select when you want to see the 16:9 video supplied by the DVD without the black bars on top and bottom, even though you have a TV with a 4:3 ratio screen (extreme left and right portion of the movie picture will be cut off).

• 4:3 Letter Box

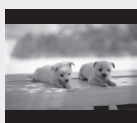

Select when you want to see the total 16:9 ratio screen DVD supplies, even though you have a TV with a 4:3 ratio screen. Black bars will appear at the top and bottom of the screen.

• 16:9 Wide



You can view the full 16:9 picture on your widescreen TV.

NOTE

- If a DVD is in the 4:3 ratio, you cannot view it in the wide screen.
- Since DVD discs are recorded in various image formats, they will look different depending on the software, the type of TV, and the TV aspect ratio setting.

Audio

Speaker Setting

Speaker Size

You can set the Speaker Size of the Center and Rear Speakers, as well as Test Tone in this mode.

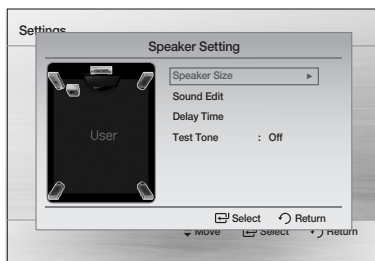

- For the Front speakers, the mode is set to Small.
- For the Subwoofer, the mode is set to Present.
- For the Centre and Rear speakers, you can switch the mode to Small or None.
 - **Small** : Select this when using the speakers.
 - **None** : Select this when no speaker is connected.

NOTE

- The speaker mode may vary depending on the Dolby Pro Logic and Stereo settings.

Sound Edit

You can adjust the balance and level for each speaker.

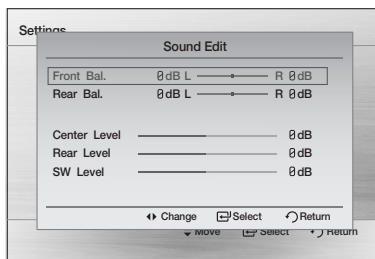

Press the **▲▼** buttons to select and adjust the desired speaker.

Press the **◀▶** buttons to adjust the settings.

Adjusting Front/Rear Speaker Balance

- You can select between 0 and -6.
- The volume decreases as you move closer to -6.

Adjusting Centre/Rear/Subwoofer Speaker Level

- The volume level can be adjusted in steps from +6dB to -6dB.
- The sound gets louder as you move closer to +6dB and quieter as you get closer to -6dB.

Delay Time

If the speakers cannot be placed at equal distances from the listening position, you can adjust the delay time of the audio signals from the Centre and Rear speakers. You can also set the Test Tone in this mode.

Setting up the Speaker Delay Time

When 5.1CH Surround Sound is played, you can enjoy the best sound if the distance between you and each speaker is the same. Since the sounds arrive at the listening position at different times depending on the placement of speakers, you can adjust this difference by adding a delay effect to the Center and Rear Speakers.

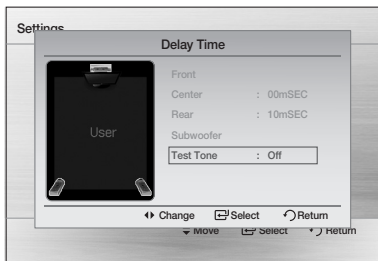

NOTE

- The Delay Time menu will be activated only when the 5.1 channel source is played.
- You can not set Centre and Rear in this mode when their Speaker Size is set to None.

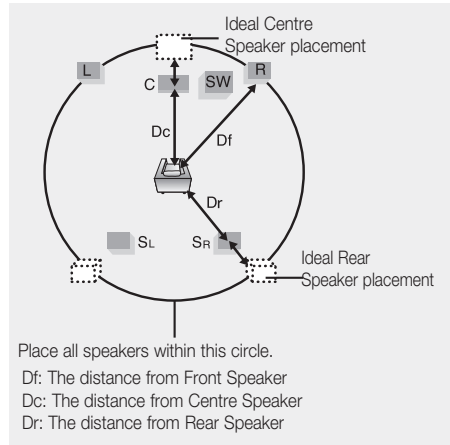

Setting the Centre Speaker

If the distance of Dc is equal to or longer than the distance of Df in the figure, set the mode as 0ms. Otherwise, change the setting according to the table.

| | | | | | | |
|----------------------------|-------|-------|-------|-------|-------|-------|
| Distance between Df and Dc | 0.00m | 0.34m | 0.68m | 1.06m | 1.40m | 1.76m |
| Delay Time | 00 ms | 01 ms | 02 ms | 03 ms | 04 ms | 05 ms |

Setting the Rear Speaker

If the distance of Dc is equal to or longer than the distance of Dr in the figure, set the mode as 0ms. Otherwise, change the setting according to the table.

| | | | | | | |
|----------------------------|-------|-------|-------|-------|-------|-------|
| Distance between Dr and Dc | 0.00m | 1.06m | 2.11m | 3.16m | 3.62m | 5.29m |
| Delay Time | 00 ms | 03 ms | 06 ms | 09 ms | 12 ms | 15 ms |

NOTE

- With PL II (Dolby Pro Logic II), the delay time may be different for each mode.
- With AC-3, the delay time can be set between 00 and 15mSEC.
- The Centre channel is only adjustable on 5.1 channel discs.

Setup

Test Tone



Use the Test Tone feature to check the speaker connections.

- Press the ◀▶ buttons to select **On**.
- The test tone will be sent to **Front Left → Center → Front Right → Rear Right → Rear Left → Subwoofer** in order.
To stop the test tone, press the **ENTER** button.

DRC (Dynamic Range Compression)

This feature balances the range between the loudest and quietest sounds. You can use this function to enjoy Dolby Digital sound when watching movies at low volume at night.

- You can select either off, 2/8, 4/8, 6/8, Full.

AV-SYNC

Video and audio sync may not match with digital TV. If this occurs, adjust the audio delay time to match the video

- You can set the audio delay time between 0 mSec and 300 mSec. Set it to the optimal status.

EQ Optimizer

Set optimal EQ automatically depending on the region.

- **Off** : Turn EQ Optimizer off.
- **On** : Turn EQ Optimizer on.

System

Initial Setting

By using the Initial Setting, you can set the language and TV aspect.

DivX(R) Registration

View DivX(R) VOD Registration Code to purchase and play DivX(R) VOD content.

Language

You can select the language you prefer for on-screen menu, disc menu, etc.

| | |
|---------------------|---|
| OSD Language | Select the language for the on-screen displays. |
| Disc Menu | Select the language for the disc menu displays. |
| Audio | Select the language for disc audio. |
| Subtitle | Select the language for disc subtitles. |

- ※ To select a language that does not appear in the menu, select OTHERS in the Disc Menu, Audio and Subtitle, and enter the language code of your country (see page 36).
- ※ You cannot select OTHERS in the OSD Language menu.

NOTE

- The selected language will only appear if it is supported on the disc.

Security

The Parental Lock function works in conjunction with DVDs that have been assigned a rating, which helps you control the types of DVDs that your family watches. There are up to 8 rating levels on a disc.

Parental Rating

Select the rating level you want to set. A larger number indicates that the program is intended for adult use only. For example, if you select up to Level 6, discs that contain Level 7, 8 will not play.

Enter the password and then press the **ENTER** button.

- The password is set to "7890" by default.
- Once the setup is complete, you will be taken to the previous screen.

Change Password

Select **Change** and enter the 4-digit password to set the parental lock using the number buttons on the remote control.

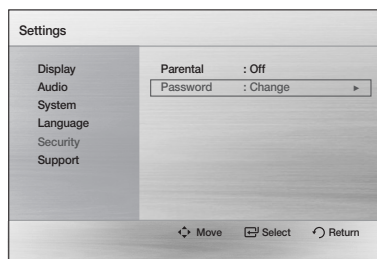

If you forgot your password

1. Remove the disc.
2. Press and hold the **STOP** (■) button on the remote control for 5 seconds or more. All settings will revert to the factory settings.

Support

Product Information

Provide the product information such as Model code, Software Version, etc.

Basic Functions

Disc Playback

1. Press the **OPEN/CLOSE** (▲) button.
2. Place a disc gently into the tray with the disc's label facing up.
3. Press the **OPEN/CLOSE** (▲) button to close the disc tray.

NOTE

- Resume function: When you stop disc play, the product remembers where you stopped, so when you press **PLAY** button again, it will pick up where you left off. (This function works only with DVDs.)
Press the **STOP** button twice during playback to disable the Resume function.
- If no buttons are pressed on the product or remote control for more than 3 minutes when the product is in Pause mode, it will change to STOP mode.
- The initial screen may appear different, depending on the content of the disc.
- Pirated discs will not play in this product because they violate the CSS(Content Scrambling System: a copy protection system) recommendations.

※ ⓧ will appear when an invalid button is pressed.

TV Screen Saver/Power Saving Function

- If the product is left in the stop mode for more than 5 minutes without being used, a screen saver will appear on your TV.
- If the product is left in the screen saver mode for more than 25 minutes, the power will automatically turn off.

Audio CD(CD-DA)/MP3/WMA Playback



1. Insert an Audio CD(CD-DA) or an MP3 Disc into the disc tray.
 - For an Audio CD, the first track will be played automatically.
 - Press the ◀▶▶▶ buttons to move to the previous/next track.
 - For the MP3/WMA disc, press the ◀▶ buttons to select **Music**, then press the **ENTER** button.
 - Press the ▲▼◀▶ buttons to select a desired file and press the **ENTER** button.
 - Press the ◀▶▶▶ buttons to move to the previous/next pages.
2. Press the **STOP** (■) button to stop playback.

NOTE

- Some MP3/WMA-CDs may not play, depending on the recording mode.
- Table of contents of a MP3-CD varies depending on the MP3/WMA track format recorded on the disc.
- The WMA-DRM files and DTS CD cannot be played.
- When MP3/WMA/CD playing, number key doesn't work.

JPEG File Playback

Images captured with a digital camera or camcorder, or JPEG files on a PC can be stored on a CD and then played back with this product.

1. Insert a JPEG disc on the disc tray.
2. Press the ◀▶ buttons to select **Photo**, and then press the **ENTER** button.
3. Press the ▲▼ buttons to select the folder you want to play, and then press the **ENTER** button.
4. Press the ▲▼ buttons to select the photo you want to play, and then press the **ENTER** button.
 - The selected file will play and slide show will start.
 - To stop slide show, press the **PAUSE (II)** button.
 - You can view the previous/next file by pressing the ◀▶ buttons during the slideshow mode.

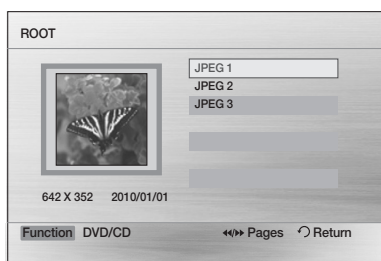

Rotate Function



Press the **GREEN(B)** or **YELLOW(C)** button during the **PAUSE** mode.

- **GREEN(B)** Button: Rotate 90° counterclockwise.
- **YELLOW(C)** Button: Rotate 90° clockwise.

NOTE

- The maximum resolutions supported by this product are 5120 x 3480 (or 19.0 MPixel) for standard JPEG files and 2048 x 1536 (or 3.0 MPixel) for progressive image files.

Using the Playback Function

Forward/Reverse Search



Press the ◀▶ buttons for Search Function.

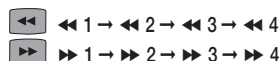

NOTE

- No sound is played in search mode.

Skipping Scenes/Songs



Press the ◀◀▶▶ buttons.

- Each time the button is pressed during playback, the previous or next chapter, track or directory (file) will be played.
- You cannot skip chapters consecutively.

Slow Motion Play



Press the **PAUSE (II)** button and then ▶▶ button for Slow Motion play.

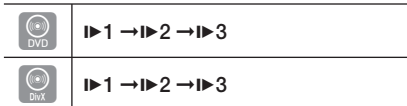

NOTE

- No sound is heard during slow playback.
- Reverse slow playback does not work.

Basic Functions

Step Motion Play



Press the **PAUSE** button repeatedly.

- The picture moves forward one frame each time the button is pressed during playback.

NOTE

- No sound is heard during step motion playback.

5 Minute Skip function



During playback, press the ◀,▶ button.

- Playback skips 5 minutes forward whenever you press the ▶ button.
- Playback skips 5 minutes backward whenever you press the ◀ button.

NOTE

- You can operate this function only on the DivX.

Using the Disc Menu



You can view the menus for the audio language, subtitle language, profile, etc.

1. During playback, press and hold the **DISC MENU** button on the remote control.
2. Press the ▲▼◀▶ buttons to make the desired selection, then press the **ENTER** button.



NOTE

- Depending on the disc, menu setup items may vary and this menu may not be available.

Using the Title Menu



For DVDs containing multiple titles, you can view the title of each movie.

1. During playback, press the **TITLE** button on the remote control.
2. Press the ▲▼◀▶ buttons to make the desired selection, then press the **ENTER** button.



NOTE

- Depending on the disc, menu setup items may vary and this menu may not be available.

Repeat Playback



DVD/DivX Repeat

You can repeat the title, chapter or the section(A-B Repeat) of the DVD/DivX.



1. During DVD/DivX playback, press the **REPEAT** button on the remote control.
2. Press the **▲▼** buttons to select a desired repeat mode, then press the **ENTER** button.
3. Press the **▲▼** buttons to select **OFF** to return to normal play, then press the **ENTER** button.



A-B Repeat Playback



You can repeatedly play back a designated section of a DVD or CD.

1. During the DVD disc or CD playback, press the **REPEAT** button on the remote control.
2. For DVD, press the **▲▼** buttons to select **A-**. For CD press the **REPEAT** button repeatedly until **A-B** appears.
3. Press the **ENTER** button at the point where you want repeat play to start (A).
4. Press the **ENTER** button at the point where you want repeat play to stop (B).
5. To return to normal playback, For DVD, press the **▲▼** buttons to select to **OFF**. For CD, press the **REPEAT** button to select to **⇒**.

NOTE

- The A-B Repeat function does not operate with DivX, MP3 or JPEG discs.

| | |
|--|--------------------------------------|
| | Title → Chapter → A → Off |
| | Track → Dir (Directory) → Disc → Off |

CD/MP3 Repeat

1. During the CD/ MP3 playback, press the **REPEAT** button repeatedly to select the repeat mode you want.

| | |
|--|--|
| | (Normal → Repeat Track → Repeat All → Random → Repeat Section A-B) |
| | (Normal → Repeat Track → Repeat Dir (Directory) → Repeat All → Random) |

Basic Functions

Displaying Disc Information

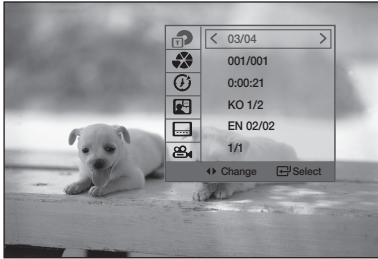

1. During playback, press the **TOOLS** button on the remote control.
2. Press the **▲▼** buttons to select the desired item.
3. Press the **◀▶** buttons to make the desired setup change and then press the **ENTER** button.
 - You may use the number buttons of the remote control to control some items.
4. To make Disc information disappear, press the **TOOLS** button again.



NOTE

- If you are playing contents from the tools menu, some functions may not be enabled depending on the disc.
- You can also select Dolby Digital or Pro Logic, depending on the disc.
- Some tools menus may differ depending on discs and files.

TOOLS menu

- **Title**(): To access the desired title when there is more than one in the disc. For example, if there is more than one movie on a DVD, each movie will be identified as a Title.
- **Chapter**(): Most DVD discs are recorded in chapters so that you can quickly find a specific chapter.
- **Playing time**(): Allows playback of the film from a desired time. You must enter the starting time as a reference. The time search function does not operate on some discs.

30 English

- **Audio**(): Refers to the film's soundtrack language. A DVD Disc can contain up to 8 audio languages.
- **Subtitle**(): Refers to the subtitle languages available in the disc. You will be able to choose the subtitle languages or, if you prefer, turn them off from the screen. A DVD Disc can contain up to 32 subtitle languages.
- **Angle**(): When a DVD contains multiple angles of a particular scene, you can use the Angle function.

Selecting the Audio Language



1. Press the **TOOLS** button.
2. Press the **▲▼** buttons to select **AUDIO** () display.
3. Press the **◀▶** buttons or numeric buttons to select the desired audio language.
 - Depending on the number of languages on a DVD disc, a different audio language is selected each time the button is pressed.

NOTE

- DTS AUDIO doesn't support.

Selecting the Subtitle Language



1. Press the **TOOLS** button.
2. Press the **▲▼** buttons to select **SUBTITLE** () display.
3. Press the **◀▶** buttons or numeric buttons to select the desired subtitle language.
 - Depending on the number of languages on a DVD disc, a different subtitle language is selected each time the button is pressed.

NOTE

- Depending on the disc, the Subtitle and Audio Language functions may not be available.
- On the DivX file format, the subtitle languages may be represented by only numbers.

Caption Function



- You must have some experience with video extraction and editing in order to use this feature properly.
- To use the caption function, save the caption file (*.smi) in the same file name as that of the DivX media file (*.avi) within the same folder.
Example. Root Samsung_007CD1.avi
 Samsung_007CD1.smi
- Up to 60 alphanumeric characters or 30 East Asian characters (2 byte characters such as Korean and Chinese) for the file name.
- The subtitle of DivX files are *.smi, *.sub, *.srt over 148 kbyte is not supported.

Angle Function



This function allows you to view the same scene in different angles.

1. Press the **TOOLS** button.
2. Press the **▲▼** buttons to select **ANGLE** () display.
3. Press the **◀▶** buttons or numeric buttons to select the desired angle.

NOTE

- The Angle function works only with discs on which multiple angles have been recorded.

Basic Functions

Sound Mode

DSP (Digital Signal Processor)/EQ

- DSP (Digital Signal Processor) : DSP modes have been designed to simulate different acoustic environments.
- EQ : You can select ROCK, POP, or CLASSIC etc. to optimize the sound for the genre of music you are playing.

Press the **DSP/EQ** button.



| | |
|-------------------------|--|
| POPS, JAZZ, ROCK | Select POPS, JAZZ, or ROCK, depending on the genre of music you're listening to. |
| STUDIO | Provides a sense of presence as if in a studio. |
| CLUB | Simulates the sound of a dance club with a throbbing bass beat. |
| HALL | Provides a clear vocal as if listening in a concert hall. |
| MOVIE | Provides the feeling of a movie cinema. |
| CHURCH | Provides the feeling of being in a grand church. |
| PASS | Select this for normal listening. |

Dolby Pro Logic II Mode

You can select the desired Dolby Pro Logic II audio mode, P.Bass or MP3 Enhancement function.

Press the  **PL II** button.



| | |
|-----------------------|--|
| MUSIC | When listening to music, you can experience sound effects as if you are listening to the actual performance. |
| CINEMA | Adds realism to the movie soundtrack. |
| PROLOG | You can listen to a 2CH sound source in 5.1CH surround sound with all speakers active. - A specific speaker(s) may not be output depending on the input signal. |
| MATRIX | You will hear multi-channel surround sound. |
| STEREO | Select this to listen to sound from the front left and right speakers and the subwoofer only. |
| MP3ENH | You can upscale your MP3 level sound (24 kHz, 8bit) to CD level sound (44.1 kHz, 16bit). The MP3 Enhancement function is only available MP3 file. |
| POWER BASS ON | This function stresses low tones providing thudding sound effects. |
| POWER BASS OFF | POWER BASS is turned off. |

NOTE





- When selecting Pro Logic II mode, connect your external device to the AUDIO INPUT jacks (L and R) on the product. If you connect to only one of the inputs (L or R), you cannot listen to surround sound.
- The Pro Logic II function is only available in Stereo mode.
- The P.BASS function is only available with 2 channel LPCM sources such as MP3, Divx, CD and WMA.

Listening to Radio

Using buttons on the Remote Control

1. Press the **FUNCTION** button to select **FM**.
2. Tune in to the desired station.
 - **Automatic Tuning 1** : When the **◀▶** buttons is pressed, a preset broadcast station is selected.
 - **Automatic Tuning 2** : Press and hold the **TUNING (Δ, ∇)** buttons to automatically search for active broadcasting stations.
 - **Manual Tuning** : Press the **TUNING (Δ, ∇)** buttons to increase or decrease the frequency incrementally.

Using buttons on the product

1. Press the **FUNCTION** () button to select **FM**.
2. Select a broadcast station.
 - **Automatic Tuning 1** : Press the **STOP** () button to select **PRESET** and then press the **◀▶** buttons to select the preset station.
 - **Automatic Tuning 2** : Press the **STOP** () button to select **MANUAL** and then press and hold the **◀▶** buttons to automatically search the band.
 - **Manual Tuning** : Press the **STOP** () button to select **MANUAL** and then press the **◀▶** buttons to tune in to a lower or higher frequency.

Setting Mono/Stereo

Press the **MO/ST** button.

- Each time the button is pressed, the sound switches between **STEREO** and **MONO**.
- In a poor reception area, select **MONO** for a clear, interference-free broadcast.



Presetting Stations

Example : Presetting FM 89.10 in the memory

1. Press the **FUNCTION** button to select **FM**.
2. Press the **TUNING (Δ, ∇)** buttons to select <89.10>.
3. Press the **TUNER MEMORY** button.
 - Number flashes on the display.
4. Press the **◀▶** buttons to select preset number.
 - You can select between 1 and 15 presets.
5. Press the **TUNER MEMORY** button again.
 - Press the **TUNER MEMORY** button before number disappears from the display.
 - Number disappears from the display and the station is stored in memory.
6. To preset another station, repeat steps 2 to 5.
 - To tune in to a preset station, press the **◀▶** buttons on the remote control to select a channel.



Advanced Functions

USB Function

Playing Media Files using the USB Host Feature

You can enjoy media files such as pictures, movies and music saved on an MP3 player, USB memory stick or digital camera in high quality video with 5.1 channel sound by connecting the storage device to the USB port of the product.

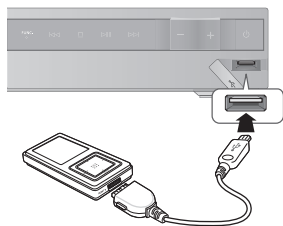

1. Connect the USB device to the USB port on the front panel of the product.
2. Press the **FUNCTION** button to select USB.
 - **USB** appears on the display screen and then disappears.
3. Press the **◀▶** buttons to select **Videos**, **Music** or **Photo**.
 - Select a file to play.

Safe USB Removal

To prevent damage to the memory stored in the USB device, perform safe removal before disconnecting the USB cable.

- Press the **YELLOW(C)** button.
 - **REMOVE** will appear on the display.
- Remove the USB cable.

NOTE

- To listen to your music files with 5.1 channel sound, you must set the Dolby Pro Logic II mode to Matrix. (See page 32)
- Remove the USB cable from the USB port slowly. Otherwise, it may cause damage to the USB port.

CD Ripping



Converts audio sound of the CDDA (Compact Disc Digital Audio) into a MP3 file format before sending to a USB storage device.

1. Connect the USB device to your product.
2. Insert the CDDA disc into the CD tray.
3. Press the **CD RIPPING** button.
 - To start ripping the current track, press the **CD RIPPING** button on the remote control while the system is playing a track or stopped temporarily.
 - To rip the entire CD, press and hold the **CD RIPPING** button on the remote control. -"FULL CD RIPPING" appears on the display and ripping starts.
4. Press the **STOP** (■) button to stop ripping.
 - When the CD ripping is done, a directory named "RIPPING" will be created in the USB device and the ripped file will be saved in a format of "SAM-XXXX".MP3".



NOTE

- Do not disconnect the USB connection or the power cable during the CD ripping. Otherwise, it may cause damage to the data. To stop CD ripping, press the STOP button and disconnect the USB device after the system stops playing the CD completely.
- If you disconnect the USB connection during the CD ripping, the system will turn off and you will not be able to delete the ripped file.
- If you connect the USB device to the system while it is playing a CD, the system stops temporarily and will play again.
- DTS-CDs cannot be ripped.
- If the ripping duration is less than 5 seconds, a ripping file may not be created.
- CD ripping works only if the USB device is formatted in the FAT file system. (The NTFS file system is not supported.)

For a list of compliant devices, refer to the specification of the USB host.
- The ripping is performed at a normal speed of x3. The ripping time may be longer with some USB devices.
- While the system is ripping a CD, the audio sound will not be output.
- Do not put touch or move the system while it is ripping a CD.
- When HDMI AUDIO is set to On, the CD Ripping function is not supported.

Troubleshooting

Refer to the chart below when this product does not function properly. If the problem you are experiencing is not listed below or if the instruction below does not help, turn off the product, disconnect the power cord, and contact the nearest authorized dealer or Samsung Electronics Service Centre.

| Symptom | Check/Remedy |
|---|--|
| I cannot eject the disc. | <ul style="list-style-type: none"> • Is the power cord plugged securely into the outlet? • Turn off the power and then turn it back on. |
| Playback does not start. | <ul style="list-style-type: none"> • Check the region number of the DVD. DVD discs purchased from abroad may not be playable. • CD-ROMs and DVD-ROMs cannot be played on this product. • Make sure that the rating level is correct. |
| Playback does not start immediately when the Play/Pause button is pressed. | <ul style="list-style-type: none"> • Are you using a deformed disc or a disc with scratches on the surface? • Wipe the disc clean. |
| Sound is not produced. | <ul style="list-style-type: none"> • No sound is heard during fast playback, slow playback, and step motion playback. • Are the speakers connected properly? Is the speaker setup correctly customized? • Is the disc severely damaged? |
| Sound can be heard only from a few speakers and not all 6. | <ul style="list-style-type: none"> • On certain DVD discs, sound is output from the front speakers only. • Check if the speakers are connected properly. • Adjust the volume. • When listening to a CD, radio or TV, sound is output to the front speakers only. Select "PROLOG" by pressing  PL II (Dolby Pro Logic II) on the remote control to use all six speakers. |
| Dolby Digital 5.1 CH Surround Sound is not produced. | <ul style="list-style-type: none"> • Is there "Dolby Digital 5.1 CH" mark on the disc? Dolby Digital 5.1 CH Surround Sound is produced only if the disc is recorded with 5.1 channel sound. • Is the audio language correctly set to Dolby Digital 5.1-CH in the information display? |
| The remote control does not work. | <ul style="list-style-type: none"> • Is the remote control being operated within its operation range of angle and distance? • Are the batteries drained? • Have you selected the mode (DVD RECEIVER/TV) functions of the remote control (DVD RECEIVER/TV) correctly? |
| <ul style="list-style-type: none"> • Disc is rotating but no picture is produced. • Picture quality is poor and picture is shaking. | <ul style="list-style-type: none"> • Is the TV power on? • Are the video cables connected properly? • Is the disc dirty or damaged? • A poorly manufactured disc may not be playable. |
| Audio language and subtitles do not work. | <ul style="list-style-type: none"> • Audio language and subtitles will not work if the disc does not contain them. |
| The Disc/Title menu screen does not appear even when the Disc/Title function is selected. | <ul style="list-style-type: none"> • Are you using a disc that does not contain menus? |
| Aspect ratio cannot be changed. | <ul style="list-style-type: none"> • You can play 16:9 DVDs in 16:9 WIDE mode, 4:3 LETTER BOX mode, or 4:3 PAN SCAN mode, but 4:3 DVDs can be seen in 4:3 ratio only. Refer to the DVD disc jacket and then select the appropriate function. |

Other Information

| Symptom | Check/Remedy |
|--|---|
| <ul style="list-style-type: none"> The product is not working. (Example: The power goes out or the front panel key doesn't work or a strange noise is heard.) The product is not working normally. | <ul style="list-style-type: none"> Press and hold the STOP (■) button on the remote control for longer than 5 seconds with no disc (reset function). <p>Using the RESET function will erase all stored settings. Do not use this unless necessary.</p> |
| The rating level password has been forgotten. | <ul style="list-style-type: none"> While "NO DISC" message appears on the display of the product, press and hold the remote control's STOP (■) button for longer than 5 seconds. "INIT" appears on the display and all settings will return to the default values. And then press the POWER button. <p>Using the RESET function will erase all stored settings. Do not use this unless necessary.</p> |
| Can't receive radio broadcast. | <ul style="list-style-type: none"> Is the antenna connected properly? If the antenna's input signal is weak, install an external FM antenna in an area with good reception. |

Language code list

Enter the appropriate code number for OTHERS in the Disc Menu, Audio and Subtitle. (See page 25).

| Code | Language | Code | Language | Code | Language | Code | Language | Code | Language | Code | Language |
|------|-----------------|------|--------------|------|------------------|------|----------------|------|----------------|------|------------|
| 1027 | Afar | 1142 | Greek | 1239 | Interlingue | 1345 | Malagasy | 1482 | Kirundi | 1527 | Tajik |
| 1028 | Abkhazian | 1144 | English | 1245 | Inupiak | 1347 | Maori | 1483 | Romanian | 1528 | Thai |
| 1032 | Afrikaans | 1145 | Esperanto | 1248 | Indonesian | 1349 | Macedonian | 1489 | Russian | 1529 | Tigrinya |
| 1039 | Amharic | 1149 | Spanish | 1253 | Icelandic | 1350 | Malayalam | 1491 | Kinyarwanda | 1531 | Turkmen |
| 1044 | Arabic | 1150 | Estonian | 1254 | Italian | 1352 | Mongolian | 1495 | Sanskrit | 1532 | Tagalog |
| 1045 | Assamese | 1151 | Basque | 1257 | Hebrew | 1353 | Moldavian | 1498 | Sindhi | 1534 | Setswana |
| 1051 | Aymara | 1157 | Persian | 1261 | Japanese | 1356 | Marathi | 1501 | Sangro | 1535 | Tonga |
| 1052 | Azerbaijani | 1165 | Finnish | 1269 | Yiddish | 1357 | Malay | 1502 | Serbo-Croatian | 1538 | Turkish |
| 1053 | Bashkir | 1166 | Fiji | 1283 | Javanese | 1358 | Maltese | 1503 | Singhalese | 1539 | Tsonga |
| 1057 | Byelorussian | 1171 | Faeroese | 1287 | Georgian | 1363 | Burmese | 1505 | Slovak | 1540 | Tatar |
| 1059 | Bulgarian | 1174 | French | 1297 | Kazakh | 1365 | Nauru | 1506 | Slovenian | 1543 | Twi |
| 1060 | Bihari | 1181 | Frisian | 1298 | Greenlandic | 1369 | Nepali | 1507 | Samoan | 1557 | Ukrainian |
| 1069 | Bislama | 1183 | Irish | 1299 | Cambodian | 1376 | Dutch | 1508 | Shona | 1564 | Urdu |
| 1066 | Bengali; Bangla | 1186 | Scots Gaelic | 1300 | Canada | 1379 | Norwegian | 1509 | Somali | 1572 | Uzbek |
| 1067 | Tibetan | 1194 | Galician | 1301 | Korean | 1393 | Occitan | 1511 | Albanian | 1581 | Vietnamese |
| 1070 | Breton | 1196 | Guarani | 1305 | Kashmiri | 1403 | (Afan) Oromo | 1512 | Serbian | 1587 | Volapuk |
| 1079 | Catalan | 1203 | Gujarati | 1307 | Kurdish | 1408 | Oriya | 1513 | Siswati | 1613 | Wolof |
| 1093 | Corsican | 1209 | Hausa | 1311 | Kirghiz | 1417 | Punjabi | 1514 | Sesotho | 1632 | Xhosa |
| 1097 | Czech | 1217 | Hindi | 1313 | Latin | 1428 | Polish | 1515 | Sundanese | 1665 | Yoruba |
| 1103 | Welsh | 1226 | Croatian | 1326 | Lingala | 1435 | Pashto, Pushto | 1516 | Swedish | 1684 | Chinese |
| 1105 | Danish | 1229 | Hungarian | 1327 | Laotian | 1436 | Portuguese | 1517 | Swahili | 1697 | Zulu |
| 1109 | German | 1233 | Armenian | 1332 | Lithuanian | 1463 | Quechua | 1521 | Tamil | | |
| 1130 | Bhutani | 1235 | Interlingua | 1334 | Latvian, Lettish | 1481 | Rhaeto-Romance | 1525 | Tegulu | | |

Specifications

| | | | | |
|--------------|------------------------------|--|-------------|------------|
| General | Weight | 2.6 Kg | | |
| | Dimensions | 430.0 (W) x 60.0 (H) x 290.0 (D) mm | | |
| | Operating Temperature Range | +5°C~+35°C | | |
| | Operating Humidity Range | 10 % to 75 % | | |
| FM Tuner | Signal/noise ratio | 70 dB | | |
| | Usable sensitivity | 10 dB | | |
| | Total harmonic distortion | 0.5 % | | |
| Disc | DVD (Digital Versatile Disc) | Reading Speed : 3.49 ~ 4.06 m/sec. Approx. Play Time (Single Sided, Single Layer Disc) : 135 min. | | |
| | CD : 12 cm (COMPACT DISC) | Reading Speed : 4.8 ~ 5.6 m/sec. Maximum Play Time : 74 min. | | |
| | CD : 8cm (COMPACT DISC) | Reading Speed : 4.8 ~ 5.6 m/sec. Maximum Play Time : 20 min. | | |
| Video Output | Composite Video | 480i(576i) 1 channel : 1.0 Vp-p (75 Ω load) | | |
| | Component Video | 480i(576i) Y : 1.0 Vp-p (75 Ω load) Pr : 0.70 Vp-p (75 Ω load) Pb : 0.70 Vp-p (75 Ω load) | | |
| Amplifier | Front speaker output | 55W x 2(3Ω) | | |
| | Centre speaker output | 55W(3Ω) | | |
| | Rear speaker output | 55W x 2(3Ω) | | |
| | Subwoofer output | 55W(3Ω) | | |
| | Frequency range | 20Hz~20KHz | | |
| | S/N Ratio | 60dB | | |
| | Channel separation | 60dB | | |
| | Input sensitivity | (AUX)400mV | | |
| Speaker | Speaker system | 5.1ch speaker system | | |
| | | Front/Rear | Centre | Subwoofer |
| | Impedance | 3 Ω | 3 Ω | 3 Ω |
| | Frequency range | 140Hz~20KHz | 140Hz~20KHz | 40Hz~160Hz |
| | Output sound pressure level | 86dB/W/M | 86dB/W/M | 88dB/W/M |
| | Rated input | 55W | 55W | 55W |
| | Maximum input | 110W | 110W | 110W |
| | Dimensions (W x H x D) | Front/Rear : 84 x 104.5 x 68.5 mm Centre : 84 x 104.5 x 68.5 mm Subwoofer : 155 x 350 x 285 mm | | |
| | Weights | Front/Rear : 0.4 Kg, Centre : 0.4 Kg Subwoofer : 3.8 Kg | | |

*: Nominal specification

- Samsung Electronics Co., Ltd reserves the right to change the specifications without notice.
- Weight and dimensions are approximate.
- Design and specifications are subject to change without prior notice.
- For the power supply and Power Consumption, refer to the label attached to the product.

Contact SAMSUNG WORLD WIDE

If you have any questions or comments relating to Samsung products, please contact the SAMSUNG customer care center.

| Area | Contact Center ☎ | Web Site |
|------------------------|---|--|
| ■ North America | | |
| Canada | 1-800-SAMSUNG (726-7864) | www.samsung.com |
| Mexico | 01-800-SAMSUNG (726-7864) | www.samsung.com |
| U.S.A | 1-800-SAMSUNG (726-7864) | www.samsung.com |
| ■ Latin America | | |
| Argentina | 0800-333-3733 | www.samsung.com |
| Brazil | 0800-124-421 4004-0000 | www.samsung.com |
| Chile | 800-SAMSUNG (726-7864) | www.samsung.com |
| Nicaragua | 00-1800-5077267 | www.samsung.com |
| Honduras | 800-7919267 | www.samsung.com |
| Costa Rica | 0-800-507-7267 | www.samsung.com |
| Ecuador | 1-800-10-7267 | www.samsung.com |
| El Salvador | 800-6225 | www.samsung.com |
| Guatemala | 1-800-299-0013 | www.samsung.com |
| Jamaica | 1-800-234-7267 | www.samsung.com |
| Panama | 800-7267 | www.samsung.com |
| Puerto Rico | 1-800-682-3180 | www.samsung.com |
| Rep. Dominica | 1-800-751-2676 | www.samsung.com |
| Trinidad & Tobago | 1-800-SAMSUNG (726-7864) | www.samsung.com |
| Venezuela | 0-800-100-5303 | www.samsung.com |
| Colombia | 01-8000112112 | www.samsung.com |
| ■ Europe | | |
| Austria | 0810 - SAMSUNG (7267864, € 0.07/min) | www.samsung.com |
| Belgium | 02-201-24-18 | www.samsung.com/ be (Dutch) www.samsung.com/ be_fr (French) |
| Czech | 800 - SAMSUNG (800-726786) | www.samsung.com |
| Denmark | 70 70 19 70 | www.samsung.com |
| Finland | 030 - 6227 515 | www.samsung.com |
| France | 01 48 63 00 00 | www.samsung.com |
| Germany | 01805 - SAMSUNG (726-7864 € 0,14/Min) | www.samsung.com |
| Hungary | 06-80-SAMSUNG (726-7864) | www.samsung.com |
| Italia | 800-SAMSUNG (726-7864) | www.samsung.com |
| Luxemburg | 261 03 710 | www.samsung.com |
| Netherlands | 0900-SAMSUNG (0900-7267864) (€ 0,10/Min) | www.samsung.com |
| Norway | 815-56 480 | www.samsung.com |
| Poland | 0 801 1SAMSUNG (172678) 022-607-93-33 | www.samsung.com |
| Portugal | 80820-SAMSUNG (726-7864) | www.samsung.com |
| Slovakia | 0800-SAMSUNG (726-7864) | www.samsung.com |
| Spain | 902 - 1 - SAMSUNG (902 172 678) | www.samsung.com |
| Sweden | 0771 726 7864 (SAMSUNG) | www.samsung.com |
| U.K | 0845 SAMSUNG (7267864) | www.samsung.com |
| Eire | 0818 717100 | www.samsung.com |

| Area | Contact Center ☎ | Web Site |
|-----------------------------------|--|---|
| Switzerland | 0848 - SAMSUNG (7267864, CHF 0.08/min) | www.samsung.com/ch www.samsung.com/ ch_fr/ (French) |
| Lithuania | 8-800-77777 | www.samsung.com |
| Latvia | 8000-7267 | www.samsung.com |
| Estonia | 800-7267 | www.samsung.com |
| ■ CIS | | |
| Russia | 8-800-555-55-55 | www.samsung.com |
| Georgia | 8-800-555-555 | |
| Armenia | 0-800-05-555 | |
| Azerbaijan | 088-55-55-555 | |
| Kazakhstan | 8-10-800-500-55-500 | |
| Uzbekistan | 8-10-800-500-55-500 | www.samsung.com |
| Kyrgyzstan | 00-800-500-55-500 | www.samsung.com |
| Tadjikistan | 8-10-800-500-55-500 | www.samsung.com |
| Ukraine | 0-800-502-000 | www.samsung.ua www.samsung.com/ ua_ru |
| Belarus | 810-800-500-55-500 | |
| Moldova | 00-800-500-55-500 | |
| ■ Asia Pacific | | |
| Australia | 1300 362 603 | www.samsung.com |
| New Zealand | 0800 SAMSUNG (0800 726 786) | www.samsung.com |
| China | 400-810-5858 010-6475 1880 | www.samsung.com |
| Hong Kong | (852) 3698-4698 | www.samsung.com/ hk www.samsung.com/ hk_en/ |
| India | 3030 8282 1800 110011 1800 3000 8282 1800 266 8282 | www.samsung.com |
| Indonesia | 0800-112-8888 021-5699-7777 | www.samsung.com |
| Japan | 0120-327-527 | www.samsung.com |
| Malaysia | 1800-88-9999 | www.samsung.com |
| Philippines | 1-800-10-SAMSUNG (726-7864) 1-800-3-SAMSUNG (726-7864) 1-800-8-SAMSUNG (726-7864) 02-5805777 | www.samsung.com |
| Singapore | 1800-SAMSUNG (726-7864) | www.samsung.com |
| Thailand | 1800-29-3232 02-689-3232 | www.samsung.com |
| Taiwan | 0800-329-999 | www.samsung.com |
| Vietnam | 1 800 588 889 | www.samsung.com |
| ■ Middle East & Africa | | |
| Turkey | 444 77 11 | www.samsung.com |
| South Africa | 0860-SAMSUNG (726-7864) | www.samsung.com |
| U.A.E | 800-SAMSUNG (726-7864) | www.samsung.com |
| Bahrain | 8000-4726 | |
| Jordan | 800-22273 | |



Correct disposal of batteries in this product

(Applicable in the European Union and other European countries with separate battery return systems.)

This marking on the battery, manual or packaging indicates that the batteries in this product should not be disposed of with other household waste at the end of their working life. Where marked, the chemical symbols Hg, Cd or Pb indicate that the battery contains mercury, cadmium or lead above the reference levels in EC Directive 2006/66. If batteries are not properly disposed of, these substances can cause harm to human health or the environment.

To protect natural resources and to promote material reuse, please separate batteries from other types of waste and recycle them through your local, free battery return system.



Correct Disposal of This Product (Waste Electrical & Electronic Equipment)

(Applicable in the European Union and other European countries with separate collection systems)

This marking on the product, accessories or literature indicates that the product and its electronic accessories (e.g. charger, headset, USB cable) should not be disposed of with other household waste at the end of their working life. To prevent possible harm to the environment or human health from uncontrolled waste disposal, please separate these items from other types of waste and recycle them responsibly to promote the sustainable reuse of material resources.

Household users should contact either the retailer where they purchased this product, or their local government office, for details of where and how they can take these items for environmentally safe recycling.

Business users should contact their supplier and check the terms and conditions of the purchase contract. This product and its electronic accessories should not be mixed with other commercial wastes for disposal.

Code No. AH68-02254B