

RL27T***



Refrigerator user manual

English

imagine the possibilities

Thank you for purchasing a Samsung product.
To receive a more complete service,
please register your product at
www.samsung.com/register

SAMSUNG









Built In Appliance

Safety information



SAFETY INFORMATION

- Before operating the appliance, please read this manual thoroughly and retain it at a safe place near the appliance for your future reference.
- Use this appliance only for its intended purpose as described in this instruction manual. This appliance is not intended for use by persons (including children) with reduced physical, sensory or mental capabilities, or lack of experience and knowledge, unless they have been given supervision or instruction concerning use of the appliance by a person responsible for their safety.
- Warnings and Important Safety Instructions in this manual do not cover all possible conditions and situations that may occur. It is your responsibility to use common sense, caution, and care when installing, maintaining, and operating your appliance.
- Because these following operating instructions cover various models, the characteristics of your refrigerator may differ slightly from those described in this manual and not all warning signs may be applicable. If you have any questions or concerns, contact your nearest service center or find help and information online at www.samsung.com.

Important safety symbols and precautions :

	Hazards or unsafe practices that may result in severe personal injury or death .
	Hazards or unsafe practices that may result in minor personal injury or property damage .
	Do NOT attempt.
	Do NOT disassemble.
	Do NOT touch.
	Follow directions carefully.
	Unplug the power plug from the wall socket.
	Make sure the machine is grounded to prevent electric shock.

2_ Safety information

	Call the contact center for help.
	Note.

These warning signs are here to prevent injury to you and others. Please follow them carefully. After reading this section, keep it in a safe place for future reference.

CE Notice

This product has been determined to be in compliance with the Low Voltage Directive (2006/95/EC), the Electromagnetic Compatibility Directive (2004/108/EC) and the Eco-Design Directive(2009/125/EC) implemented by Regulation (EC) No 643/2009 of the European Union.

SEVERE WARNING SIGNS FOR TRANSPORTATION AND SITE

- When transporting and installing the appliance, care should be taken to ensure that no parts of the refrigerating circuit are damaged.
- R600a or R134a is used as a refrigerant. Check the compressor label on the rear of the appliance or the rating label inside the refrigerator to see which refrigerant is used for your refrigerator.
- When this product contains flammable gas (Refrigerant R600a),
 - Refrigerant leaking from the pipe work could ignite or cause an eye injury. If a leak is detected, avoid any naked flames or potential sources of ignition and air the room in which the appliance is standing for several minutes.
 - In order to avoid the creation of a flammable gas-air mixture if a leak in the refrigerating circuit occurs, the size of the room in which the appliance may be sited depends on the amount of refrigerant used.
 - Never start up an appliance showing any signs of damage. If in doubt, consult your dealer. The room where the refrigerator will be sited must be 1m³ in size for every 8g of R600a refrigerant inside the appliance. The amount of refrigerant in your particular appliance is shown on the identification plate inside the appliance.
 - If the appliance contains isobutane refrigerant (R600a), a natural gas with high environmental

compatibility that is, however, also combustible. When transporting and installing the appliance, care should be taken to ensure that no parts of the refrigerating circuit are damaged.



WARNING

SEVERE WARNING SIGNS FOR INSTALLATION



- Do not install this appliance in a humid, oily or dusty location, in a location exposed to direct sunlight and water (rain drops).
- Deteriorated insulation of electrical parts may cause an electric shock or fire.
- Do not place this refrigerator in direct sunlight or expose to the heat from stoves, room heaters or other appliances.
- Do not plug several appliances into the same multiple power board.
The refrigerator should always be plugged into its own individual electrical outlet which has a voltage rating that matched the rating plate.
- This provides the best performance and also prevents overloading house wiring circuits, which could cause a fire hazard from overheated wires. If the wall socket is loose, do not insert the power plug.
- There is a risk of electric shock or fire.
- Do not use a cord that shows cracks or abrasion damage along its length or at either end.
- Do not bend the power cord excessively or place heavy articles on it.
- Do not use aerosols near the refrigerator.
- Aerosols used near the refrigerator may cause an explosion or fire.
- Do not install this appliance in a location where gas may leak.
- This may result in an electric shock or fire.



- The installation or any service of this appliance is recommended by a qualified technician or service company.
- Failing to do so may result in an electric shock, fire, explosion, problems with the product, or injury.
- This refrigerator must be properly installed and located in accordance with the manual before it is used.
- Connect the power plug in proper position with the cord hanging down.
- If you connect the power plug upside down, wire can get cut off and a cause fire or an electric shock.
- Make sure that the power plug is not squashed or damaged by the back of the refrigerator.
- When moving the refrigerator, be careful not to roll over or damage the power cord.

- This constitutes a fire hazard.
- The appliance must be positioned so that the plug is accessible after installation.



- The refrigerator must be grounded.
 - You must ground the refrigerator to prevent any power leakages or electric shocks caused by current leakage from the refrigerator.
- Never use gas pipes, telephone lines or other potential lightening rods as ground.
- Improper use of the ground plug can result in an electric shock.



- If the power cord is damaged, have it replaced immediately by the manufacturer or its service agent.
- The fuse on the refrigerator must be changed by a qualified technician or service company.
- Failing to do so may result in an electric shock or personal injury.



CAUTION

CAUTION SIGNS FOR INSTALLATION



- Keep ventilation opening in the appliance enclosure or mounting structure clear of obstruction.
- Allow the appliance to stand for 2 hours after installation.



WARNING

SEVERE WARNING SIGNS FOR USING



- Do not insert the power plug with wet hands.
- Do not store articles on the top of the appliance.
- When you open or close the door, the articles may fall and cause a personal injury and/or material damage.
- Do not put items filled with water on the refrigerator.
- If spilled, there is a risk of fire or electric shock.
- Do not let children hang on the door.
- Failure to do so may cause serious personal injury.
- Do not leave the doors of the refrigerator open while the refrigerator is unattended and do not let children enter inside the refrigerator.
- Do not allow babies or children go inside the drawer.
- It can cause death from suffocation by entrapment or personal injury.
- Do not sit on the Freezer door.
- The door may be broken and cause a personal injury.

- To prevent children entrapment, you must reinstall the divider using provided screws after cleaning or other actions if you removed the divider from the drawer.
- Do not store volatile or flammable substances such as benzene, thinner, alcohol, ether or LP gas in the refrigerator.
- The storage of any of such products may cause an explosion.
- Do not store low temperature-sensitive pharmaceutical products, scientific materials or other low temperature-sensitive products in the refrigerator.
- Products that require strict temperature controls must not be stored in the refrigerator.
- Do not place or use electrical appliance inside the refrigerator, unless they are of a type recommended by the manufacturer.
- Do not use a hair dryer to dry the inside of the refrigerator. Do not place a lighted candle in the refrigerator for removing bad odors.
- This may result in an electric shock or fire.
- Do not touch the inside walls of the freezer or products stored in the freezer with wet hands.
- This may cause frostbite.
- Do not use mechanical devices or any other means to accelerate the defrosting process, other than those recommended by the manufacturer.
- Do not damage the refrigerant circuit.

- ★ • This product is intended only for the storage of food in a domestic environment.
- Bottles should be stored tightly together so that they do not fall out.
- In the event of a gas leak (such as propane gas, LP gas, etc.), ventilate immediately without touching the power plug. Do not touch the appliance or power cord.
- Do not use a ventilating fan.
- A spark may result in an explosion or fire.
- Use only the LED Lamps provided by manufacturer or service agent.
- Children should be supervised to ensure that they do not play with and/or climb into the appliance.

- ✂ • Do not disassemble or repair the refrigerator by yourself.
- You run a risk of causing a fire, malfunction and/or personal injury. In case of malfunction, please contact your service agent.



- If the appliance generates a strange noise, a burning smell, or smoke, unplug the power plug immediately and contact your nearest service center.
- Failing to do so may result in an electric or fire hazards.
- If you experience difficulty when changing the light, contact service agent.
- If the products is equipped with the LED Lamp, do not disassemble the Lamp Cover and LED Lamp by yourself.
- Please contact your service agent.
- If any dust or water is in the refrigerator, pull out power plug and contact your Samsung Electronics service center.
- There is a risk of fire.



CAUTION SIGNS FOR USING



- ★ • To get best performance from the product,
 - Do not place foods too closely in front of the vents at the rear of the appliance as it can obstruct free air circulation in the refrigerator compartment.
 - Wrap the food up properly or place it in airtight containers before putting it into the refrigerator.
 - Do not put any newly introduced food for freezing near to already existing food.
 - Do not place carbonated or fizzy drinks in the freezer compartment. Do not put bottles or glass containers in the freezer.
 - When the contents freeze, the glass may break and cause personal injury and property damage.
 - Do not change or modify the functionality of the refrigerator.
 - Changes or modifications may result in a personal injury and/or property damage. Any changes or modifications performed by a 3rd party on this completed appliance are neither covered under Samsung warranty service, nor is Samsung responsible for safety issues and damages that result from 3rd party modifications.
 - Do not block air holes.
 - If the air holes are blocked, especially with a plastic bag, the refrigerator can be over cooled. If this cooling period lasts too long, the water filter may break and cause water leakage.
 - Do not put any newly introduced food for freezing near to already existing food.
 - Please observe maximum storage times and expiry dates of frozen goods.
 - Fill the water tank, ice tray, water cubes only with potable water.
 - The water supply to this refrigerator must only be installed/connected by a suitably qualified

4_ Safety information

person and connected to a potable water supply only.

- Do not spray volatile material such as insecticide onto the surface of the appliance.
- As well as being harmful to humans, it may also result in an electric shock, fire or problems with the product.



CAUTION SIGNS FOR CLEANING AND MAINTENANCE



- Do not directly spray water inside or outside the refrigerator.
- There is a risk of fire or electric shock.
- Do not use or place any substances sensitive to temperature such as inflammable sprays, inflammable objects, dry ice, medicine, or chemicals near the refrigerator. Do not keep volatile or inflammable objects or substances (benzene, thinner, propane gas, etc.) in the refrigerator.
- This refrigerator is for storing food only.
- This may result in a fire or an explosion.
- Do not spray cleaning products directly on the display.
- Printed letters on the display may come off.
- Remove any foreign matter or dust from the power plug pins. But do not use a wet or damp cloth when cleaning the plug, remove any foreign material or dust from the power plug pins.
- Otherwise there is a risk of fire or electric shock.



- Unplug the refrigerator before cleaning and performing maintenance.



SEVERE WARNING SIGNS FOR DISPOSAL



- Ensure that none of the pipes on the back of the appliance are damaged prior to disposal.
- R600a or R134a is used as a refrigerant. Check the compressor label on the rear of the appliance or the rating label inside the refrigerator to see which refrigerant is used for your refrigerator. When this product contains flammable gas (Refrigerant R600a), contact your local authority in regard to safe disposal of this product. Cyclopentane is used as an insulation blowing gas. The gases in insulation material require special disposal procedure. Please contact your local authorities in regard to the environmentally safe disposal of this product. Ensure that none of the pipes on the back of the

appliances are damaged prior to disposal. The pipes shall be broken in the open space.

- When disposing of this product or other refrigerators, remove the door/door seals, door latch so that small children or animals cannot become trapped inside. Leave the shelves in place so that children may not easily climb inside. Children should be supervised to ensure that they do not play with the old appliance.
- Please dispose of the packaging material for this product in an environmentally friendly manner.



ADDITIONAL TIPS FOR PROPER USAGE

- In the event of a power failure, call the local office of your Electricity Company and ask how long it is going to last.
- Most power failures that are corrected within an hour or two will not affect your refrigerator temperatures. However, you should minimize the number of door openings while the power is off.
- Should the power failure last more than 24 hours, remove all frozen food.
- If keys are provided with the refrigerator, the keys should be kept out of the reach of children and not be in the vicinity of the appliance.
- The appliance might not operate consistently (possibility of temperature becoming too warm in the refrigerator) when sited for an extended period of time below the cold end of the range of temperature for which the refrigerating appliance is designed.
- Do not store food which spoils easily at low temperature, such as bananas, melons.
- Your appliance is frost free, which means there is no need to manually defrost your appliance, as this will be carried out automatically.
- Temperature rise during defrosting can comply with ISO requirements. But if you want to prevent an undue rise in the temperature of the frozen food while defrosting the appliance, please wrap the frozen food up in several layers of newspaper.
- Any increase in temperature of frozen food during defrosting can shorten its storage life.

Saving Energy Tips

- Install the appliance in a cool, dry room with adequate ventilation.
Ensure that it is not exposed to direct sunlight and never put it near a direct source of heat (radiator, for example).
- Never block any vents or grilles on the appliance.
- Allow warm food to cool down before placing it in the appliance.
- Put frozen food in the refrigerator to thaw. You can then use the low temperatures of the frozen products to cool food in the refrigerator.
- Do not keep the door of the appliance open for too long when putting food in or taking food out. The shorter time for which the door is open, the less ice will form in the freezer.
- Clean the rear of the refrigerator regularly. Dust increases energy consumption.
- Do not set temperature colder than necessary.
- Ensure sufficient air exhaust at the refrigerator base and at the back wall of the refrigerator.
Do not cover air vent openings.
- Allow clearance to the right, left, back and top when installing.
This will help reduce power consumption and keep your energy bills lower.

Contents

SETTING UP YOUR REFRIGERATOR

..... 6

OPERATING THE SAMSUNG

REFRIGERATOR 9

TROUBLESHOOTING 11

Setting up your refrigerator

GETTING READY TO INSTALL THE REFRIGERATOR

Congratulations on your purchase of the Samsung Refrigerator. We hope you enjoy the state-of-art features and efficiencies that this new appliance offers.

Selecting the best location for the Refrigerator

- A location without direct exposure to sunlight.
- A location with level (or nearly level) flooring.
- A location with enough space for the Refrigerator doors to open easily.
- Please ensure that appliance can be moved freely in the event of maintenance & service.

 We recommend you to use this refrigerator by installing it in your furniture.

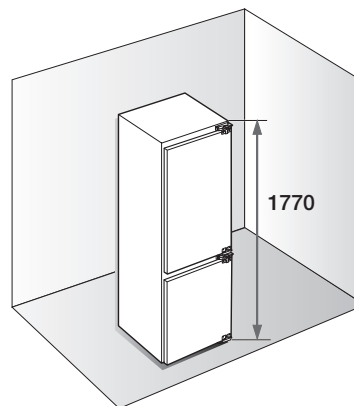

6_ Safety information

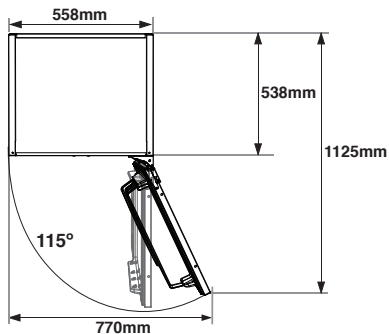

- Do not install the Refrigerator where the temperature will go below 50°F (10°C).
- Pull the unit straight out when installing, servicing or cleaning behind the refrigerator and push it straight back after work is complete. Make sure your floor can support fully loaded refrigerator.

REVERSING THE REFRIGERATOR DOOR

WARNING Before you reverse the refrigerator door, make sure to unplug the refrigerator. If this operation is not performed by After sales service, it is not covered by the warranty.

1. Remove the screws from the fridge door.

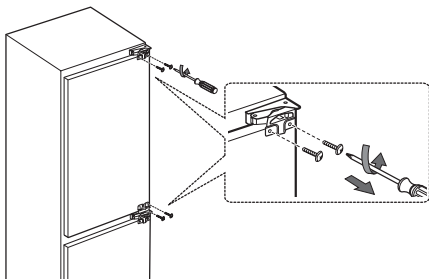

2. Remove the screws from the refrigerator. Disassemble the fridge door and hinges.

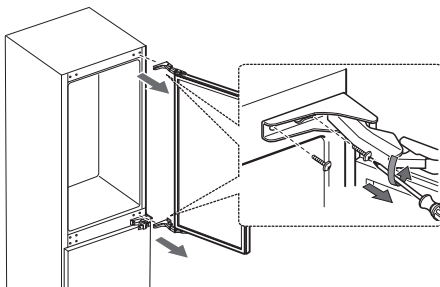

3. Remove the screws from the freezer door.

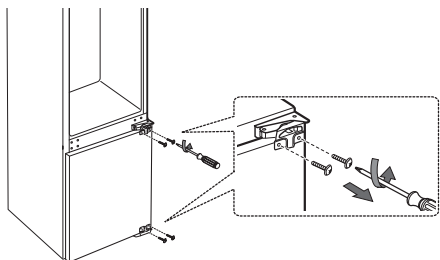

4. Remove the screws from the refrigerator. Disassemble the freezer door and hinges.

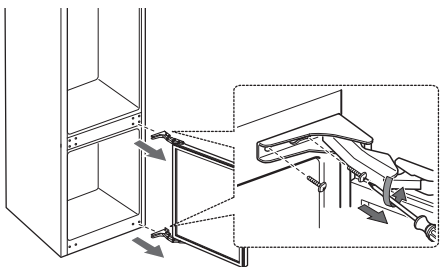

5. Switch the Screw cap from the left to the right.

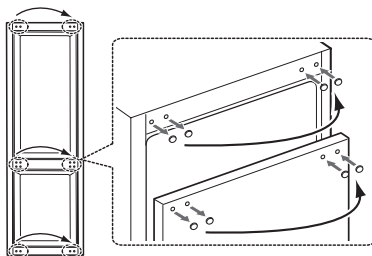

CAUTION Be careful not to get injured while removing the Screw cap.

6. Switch and flip the hinge as below.

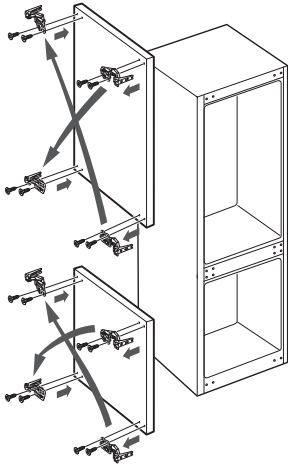

7. Tighten the screws on the refrigerator.

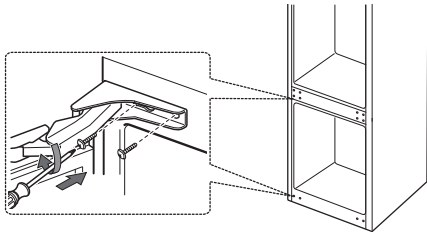

8. Carefully put the freezer door back on.
And then tighten the screws on the freezer door.

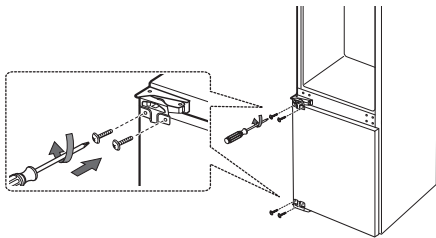

9. Tighten the screws on the refrigerator.

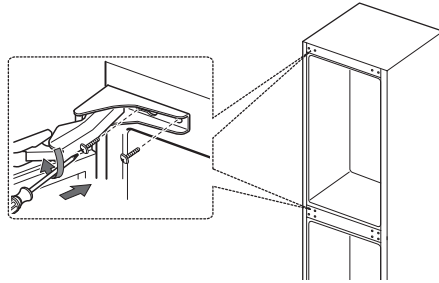

10. Carefully put the fridge door back on.
And then tighten the screws on the fridge door.

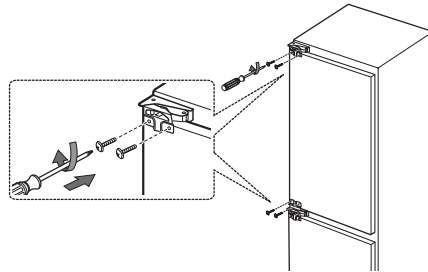

LEVELLING THE REFRIGERATOR

If the front of the appliance is slightly higher than the rear, the door can be opened and closed more easily. Turn the adjusting legs clockwise to raise and counter-clockwise to lower the height.

CHECKING THE CONTROL PANEL

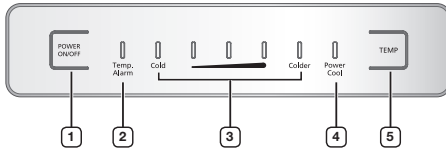

1 POWER ON/OFF	Press this button to turn on or off the power.
2 Temp. Alarm	If the temperature inside the freezer cabinet is warmer than normal, this lamp will be lit.
3 Led Lamp	There are five temperature settings, represented by five indicator lights. When all lights are on, the temperature is at its coldest.
4 Power Cool	The unit will be activated for 150 minutes in the Power cool mode.
5 TEMP	You can set the desired temperature of the fridge from Cold(5°C) to Colder(1°C). Initially, the mid-point temperature setting is selected.

 When starting the unit at first, the unit will be activated for 150 minutes in the power cool mode.

 If you need to freeze large amount of food stuff, turn on the Power Cool mode.

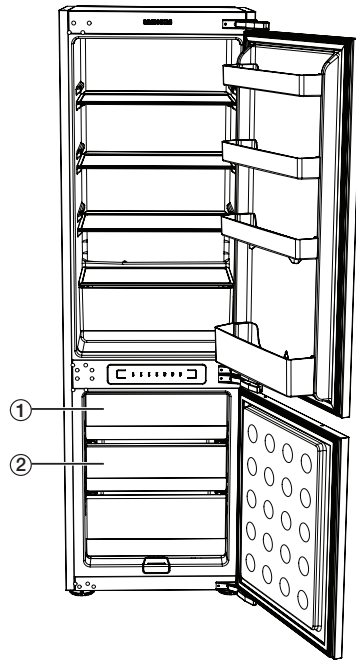

-  To get more space in the refrigerator, you can remove drawers.
- For freezing test, remove ①, ② drawers.
- To get the best energy efficiency of this product, please leave all selves, drawers on their original position like illustration above.

STORING FOOD

To get more space, you can remove drawers except the low drawer as following picture. It does not affect thermal and mechanical characteristics.

A declared storage volume of frozen food storage compartment is calculated with these drawers removed.

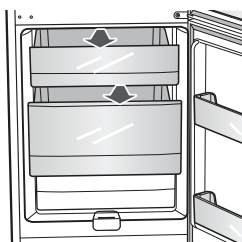

Do not touch the Evaporator with wet hands.

- Stacking of products on the freezer shelves is acceptable.

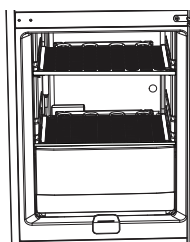

REMOVING THE INTERIOR PARTS

Shelves

Gently lift up the shelves with both hands and pull it toward you.
(Glass shelf/Foldable shelf)

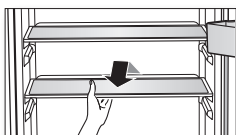

Door guards

Firmly grab the door guards with both hands and lift it up gently to remove the door guards.

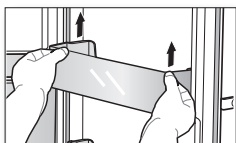

Drawers

Pull the drawers out fully then slightly lift it up to remove the drawers.

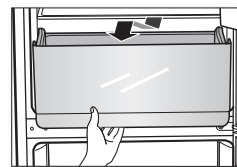

CLEANING THE REFRIGERATOR



Do not use Benzene, Thinner or Clorox™ for cleaning.

They may damage the surface of the appliance and can create a risk of fire.



Do not spray the refrigerator with water while it is plugged in, as it may cause an electric shock.

Do not clean the refrigerator with benzene, thinner or car detergent for risk of fire.

REPLACING THE LED LAMP

When the interior or exterior LED lamp has gone out, do not disassemble the lamp cover and LED lamp by yourself.



Please contact your service agents.

troubleshooting

PROBLEM	SOLUTION
The appliance is not operating at all or the temperature is too high.	<ul style="list-style-type: none"> • Check if the power plug is correctly connected. • Is the temperature control on the front panel correctly set? • Does sun shine on the appliance or are there any heat sources nearby? • If you select the POWER OFF on the control Panel, compressor does not work.
The food in the refrigerator is frozen.	<ul style="list-style-type: none"> • Is the temperature control on the front panel set to the coldest temperature? • Is the surrounding temperature too low?
There are unusual noises.	<ul style="list-style-type: none"> • Check if the appliance is installed on a stable and even floor. • Have any foreign objects fallen behind or under the appliance? • Is the noise coming from the compressor in the appliance? • A ticking sound occurs when the various accessories contract or expand.
The front corners of the appliance are warm and condensation starts to form.	<ul style="list-style-type: none"> • Heat-proof pipes are installed in the front corners of the appliance to prevent condensation from forming. When the surrounding temperature rises, this may not always be effective. However, this is not abnormal. • In very humid weather, condensation may form on the outer surface of the appliance when the moisture in the air comes into contact with the cool surface of the appliance.
You can hear a liquid bubbling in the appliance.	<ul style="list-style-type: none"> • This is the refrigerant, which cools the inside of the appliance.
There is a bad smell inside the appliance.	<ul style="list-style-type: none"> • Is there any spoiled food inside of the refrigerator? • Make sure that strong smelling food (for example, fish) is wrapped so that it is airtight. • Clean out your refrigerator periodically and throw away any spoiled or suspect food.
There is a layer of frost on the appliances walls.	<ul style="list-style-type: none"> • Are the air outlet vents blocked by food stored inside the refrigerator? • Space the food out as much as possible to improve ventilation. • Is the door fully closed?
Condensation forms on the inside wall of the appliance and around vegetables.	<ul style="list-style-type: none"> • Food with a high water content is stored uncovered with a high humidity level or the door has been left open for a long time. • Store the food with a cover or in sealed containers.

Ambient Room Temperature Limits

This refrigerator is designed to operate in ambient temperatures specified by its temperature class marked on the rating plate.

Class	Symbol	Ambient Temperature range (°C)
Extended Temperate	SN	+10 to +32
Temperate	N	+16 to +32
Subtropical	ST	+16 to +38
Tropical	T	+16 to +43

 Internal temperatures may be affected by such factors as the location of the refrigerator, ambient temperature and the frequency with which you open the door. Adjust the temperature as required to compensate for these factors.

English **Correct Disposal of This Product**
(Waste Electrical & Electronic Equipment)

(Applicable in the European Union and other European countries with separate collection systems)



This marking on the product, accessories or literature indicates that the product and its electronic accessories (e.g. charger, headset, USB cable) should not be disposed of with other household waste at the end of their working life. To prevent possible harm to the environment or human health from uncontrolled waste disposal, please separate these items from other types of waste and recycle them responsibly to promote the sustainable reuse of material resources.

Household users should contact either the retailer where they purchased this product, or their local government office, for details of where and how they can take these items for environmentally safe recycling.

Business users should contact their supplier and check the terms and conditions of the purchase contract. This product and its electronic accessories should not be mixed with other commercial wastes for disposal.

Contact SAMSUNG WORLD WIDE

If you have any questions or comments relating to Samsung products, please contact the SAMSUNG customer care center.

COUNTRY	CALL	Web site
AUSTRALIA	1300 362 603	www.samsung.com/au
COLOMBIA	01-8000112112	www.samsung.com.co
EIRE	0818 717 100	www.samsung.com/ie
HONG KONG	(852) 3698-4698	www.samsung.com/hk www.samsung.com/hk_en/
INDIA	3030 8282, 1800 110011, 1-800-3000-8282, 1800 266 8282	www.samsung.com/in
MALAYSIA	1800-88-9999	www.samsung.com/my
NEW ZEALAND	0800 SAMSUNG (726-7864)	www.samsung.com/nz
PANAMA	800-7267	www.samsung.com/latin
PHILIPPINES	1800-10-SAMSUNG (726-7864)	www.samsung.com/ph
SINGAPORE	1800-SAMSUNG (726-7864)	www.samsung.com
SOUTH AFRICA	0860-SAMSUNG (726-7864)	www.samsung.com
U.K	0330 SAMSUNG (726-7864)	www.samsung.com
VIETNAM	1 800 588 889	www.samsung.com

 In an effort to promote recycling this user manual is printed on recycled paper.

Code No. DA99-03418A REV(0.0)