

GT-E1282T user guide

- Some of the contents in this guide may differ from your device depending on the software of the device or your service provider.
- Third party services may be terminated or interrupted at any time, and Samsung makes no representation or warranty that any content or service will remain available for any period of time.
- This product includes certain free/open source software. The exact terms of the licenses, disclaimers, acknowledgements and notices are available on the Samsung's website opensource.samsung.com.

www.samsung.com

Printed in Korea
GH68-37514A
English (SWA). 09/2012. Rev. 1.1



Device layout

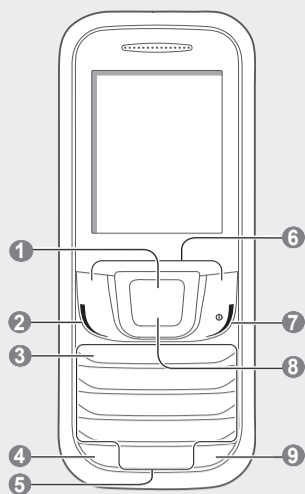

1

Navigation key

From the Home screen, access user-defined menus; In the Menu screen, scroll through menu options

Pre-defined menus might differ, depending on your service provider

2

Dial Key

Make or answer a call; From the Home screen, retrieve recently dialed, missed, or received numbers

3

Voicemail key

From the Home screen, access voice mails (press and hold)

4

Keypad lock key

From the Home screen, lock or unlock the keypad (press and hold)

5

Alphanumeric keys

6

Softkeys

Perform actions indicated at the bottom of the display

7

Power key

Turn the device on or off (press and hold); End a call; In the Menu screen, cancel an input and return to the Home screen

8

Confirm key

In the Menu screen, select the highlighted menu option, or confirm an input; From the Home screen, launch the music player

The key might perform differently, depending on your region

9

SIM card selection key

From the Home screen, switch between networks (press and hold)

Your device displays the following status indicators on the top of the screen:

Icon	Description
	No SIM card
	No signal
	Signal strength ¹
	Network searching
	GPRS network connected
	Battery power level
	Call in progress
	Call diverting activated
	New text message (SMS)
	SOS message feature activated
	Normal profile activated
	Silent profile activated

Icon	Description
	Bluetooth feature activated
	Connected with computer
	Alarm activated
	FM radio on
	Roaming (outside of normal service area)
	Memory card inserted
	10:00 Current time

1. The icon may vary depending on your SIM card setting.

Installing the SIM cards and battery

1. Remove the back cover and insert the SIM cards.



Do not bend or twist the back cover excessively. Doing so may damage the cover.

2. Insert the battery and replace the back cover.

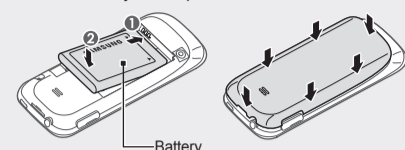

Charging the battery

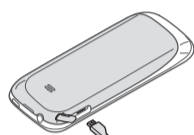

To AC power outlet

- Plug a charger into the multipurpose jack.
- Unplug the charger when charging is complete.

- Use only Samsung-approved chargers, batteries, and cables. Unapproved chargers or cables can cause batteries to explode or damage your device.
- Do not remove the battery before removing the charger. This may damage the device

- To save energy, unplug the charger when not in use. The charger does not have a power switch, so you must unplug the charger from the electric socket when not in use to avoid wasting power. The device should remain close to the electric socket while charging.

Installing a memory card

Your device accepts memory cards with maximum capacities of 4 GB. Depending on the memory card manufacturer and type, some memory cards may not be compatible with your device.

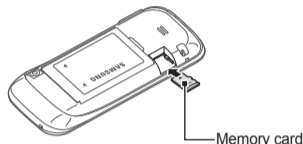

Memory card

Insert the memory card as shown in the drawing.

- The device supports only the FAT file system for memory cards. When inserting a card formatted in a different file system, the device asks to reformat the memory card.
- Frequent writing and erasing of data shortens the lifespan of memory cards.
- Do not use sharp tools to remove the memory card from the device.

Turning your device on or off

Turn your device on

Press and hold the Power key, then enter your PIN and press **<OK>**, if necessary.

Turn your device off

Press and hold the Power key.

- If the battery remains fully discharged or removed from the device, the time and date is reset.

Accessing menus

To access your device's menus or options,

Navigation key	Scroll to each menu.
Confirm key	Launch a menu or an application.
<Menu>	Open the Menu screen.
<Back>	Return to previous screen.
	Close a menu or an application and return to the Home screen.

- When you access a menu requiring the PIN2, you must enter the PIN2 supplied by the SIM card. For details, contact your service provider.
- Samsung is not responsible for any loss of passwords or private information or other damage caused by illegal software.

Entering text

Change the text input mode

Press [#]	Change to uppercase, lowercase, or switch to Number mode.
Press and hold [#]	Switch between T9 and ABC mode. Depending on your region, you might be able to use an input mode for your specific language.
Press [*]	Switch to Symbol mode.
Press and hold [*]	Select an input mode or change input language.

T9 mode

- Press the appropriate alphanumeric keys to enter an entire word.
- When the word displays correctly, press [0] to insert a space. If the word does not display, press the Navigation key up or down to select an alternate word.

ABC mode

Press an appropriate alphanumeric key until the character you want appears on the display.

Number mode

Press an appropriate alphanumeric key to enter a number.

Symbol mode

Press an appropriate alphanumeric key to enter a symbol.

Other features for text input

Navigation key	Move the cursor.
Press <Clear>	Delete characters one by one.
Press and hold <Clear>	Delete characters quickly.
Press [0]	<ul style="list-style-type: none"> Insert a space. Insert a new line (press three times).
Press [1]	Enter punctuation marks.

Making or answering a call

- To make a call, enter a phone number and press [↵].
- To end a call, press [⏏].
- To call a recently dialed number, press [↵] to select a number, and press [↵] again to dial the number.
- To make a call using the phonebook, press **<Menu>** → **Contacts**, select a contact and press [↵].
- To answer an incoming call, press [↵].

Sending and viewing messages

<Menu> → **Messages**

Send a message

- Press **Create message**.
- Press **<Options>** → **Add recipients** → **Contact list** to open the phonebook.
- Select a contact and press **<Options>** → **Add**. Or, enter a contact number.
- Scroll down and enter a text message.
- Press **<Options>** → **Send**.

View a message

Press **Inbox** and select a message to read.

Managing your contacts

Save your data such as names, phone numbers and personal information in the device memory, SIM card, or the memory card.

<Menu> → **Contacts**

Add a new contact

- Press **Create contact** → a memory location (if necessary).
- Select a number type (if necessary)
- Enter contact information and press the Confirm key.

Edit a contact

- Select a contact and press **<Options>** → **Edit**.
- Edit items and press the Confirm key to save.

Delete a contact

Select a contact and press **<Options>** → **Delete**.

- You can change the memory location by pressing **<Menu>** → **Contacts** → **Management** → **Save new contacts to** and selecting a memory location.

Listening to music

<Menu> → **Music**

Keys	Function
Confirm key	Play, pause, or resume a music.
Navigation key	<ul style="list-style-type: none"> Left: Skip backward (press); Scan backward in a file (press and hold). Right: Skip forward (press); Scan forward in a file (press and hold). Up/Down: Adjust the volume.
3	Turn shuffle mode on or off.
4	Change the repeat mode.

Browsing the web

<Menu> → **Browser**

- When you access **Browser** for the first time, you might be prompt to create an Internet profile.
- The browser may not support some WAP sites.

Navigate web pages

Keys	Function
Navigation key	Scroll up or down on a web page.
Confirm key	Select an item.
<Back>	Return to the previous page.
<Menu>	Open browser options.

Bookmark your favourite web page

- Press **<Menu>** → **Bookmarks** → **<Manage>** → **Add**.
- Enter details and press the Confirm key.

Using the alarm

<Menu> → **Organiser** → **Alarms**

Set a new alarm

- Press **<Select>**.
- Enter details and press **<Save>**.

Stop an alarm

When an alarm rings,

- Press **<Confirm>** to stop the alarm.
- Press **<Snooze>** to silence the alarm for the snooze period.

Deactivate an alarm

- Select an item and press **<Select>**.
- Set **Alarm activation to Off**.

Managing your calendar

<Menu> → **Organiser** → **Calendar**

Create an event

- Press **<Options>** → **Create**.
- Enter details of the event and press **<Options>** → **Save**.

Using the torch

- From the Home screen, press and hold the Navigation key up to activate the torch.
- From the Home screen, press and hold the Navigation key up to deactivate the torch.

Listening to the FM radio

<Menu> → **FM radio**

Activate the FM radio

- Plug a headset into the device.
- Press the Confirm key to turn on the FM radio.
- Press **<Yes>** to start automatic tuning. You will be asked to start automatic tuning when accessing the FM radio for the first time.
- Control the FM radio using the following keys:

Keys	Function
Confirm key	Turn the FM radio on or off.
Navigation key	<ul style="list-style-type: none"> Left/Right: Fine-tune the frequency; Search for the next available station (press and hold). Up/Down: Adjust the volume.

Add a radio station to the favourites list

- Plug a headset into the device.
- Press **<Options>** → **Add to Favourites**.
- Assign a key and press **<Select>**.

Using the Bluetooth feature

<Menu> → **Applications** → **Bluetooth**

Turn on the Bluetooth feature

- Press **<Options>** → **Settings** and set **Activation to On**.
- Set **My phone's visibility** to allow other devices to search your device.

Find and pair with other Bluetooth devices

- Press **Search for new devices** to find other Bluetooth devices.
- Select a device and press the Confirm key.
- Enter the PIN code, and press **<OK>** to match the PIN between the devices (if necessary).
- When the other device accepts the connection, pairing is complete.

- You might have to enter a PIN, depending on the device.

Turn off the Bluetooth feature

Select **<Options>** → **Settings** and set **Activation to Off**.

Send data using the Bluetooth feature

- Select items to send from one of your device's applications.
- Press **<Options>** → **Send via** → **Bluetooth**.

Customising your device

Settings control how applications and functions operate. Change them to customise the device. Appearances, sound profiles, call actions and many more can be customised.

<Menu> → **Settings**

Menu	Description
SIM cards management	Change the SIM/USIM card settings.
Profiles	Change alert type, ringtone, volume, etc.
Display	Alter wallpaper, theme, brightness, etc.
Time and date	Change time and date of the device.
Phone	Change device language, etc.
Applications	Set application settings.
Security	Set locks or change passwords.
Network	Change network profiles settings.
Memory	Clear memory, manage the memory card, or set default memory location.
Reset	Reset the device.

Adjusting the sound profiles

<Menu> → **Settings** → **Profiles**

Change the ringtone

- Select a profile and press **<Options>** → **Edit**.
- Press **Call ringtone**.
- Choose a ringtone and press the Confirm key.

Change the message alert tone

- Select a profile and press **<Options>** → **Edit**.
- Press **Message alert tone**.
- Choose a tone and press the Confirm key.

Adjust the volume of the ringtone

- Select a profile and press **<Options>** → **Edit**.
- Press **Volume** → **Call alert type**.
- Adjust the volume and press **<Save>**.

Adjust the volume of voice during a call

While a call is in progress, press the Navigation key up or down to adjust the volume.

- To switch to another profile, select it from the list.

Using shortcuts

 <Menu> → **Settings** → **Phone** → **Shortcuts**

Edit shortcuts

- Select a Navigation key and press <Option> → **Change**.
- Select an application to assign and press <Save>.

Customising the Home screen

Customise your Home screen with your favourite applications, contacts, calendar, and many more.

 <Menu> → **Settings** → **Display** → **Shortcuts toolbar**

Customize the shortcuts toolbar

- Press <Options> → <Edit>.
- Select items to add to the shortcuts toolbar and press <Save>. New items can be added to empty spaces.

Managing your SIM cards

Your device supports Dual SIM mode that allows the use of two networks without changing the SIM card.

 <Menu> → **Settings** → **SIM cards management**

Activate SIM cards

- Press **Network** and select a SIM card.
- Press **Change** to activate the card.

Switch SIM cards automatically

- Press **SIM auto switch** → **Activation** to select **On**.
- Set starting and ending time to use each SIM card.

Change names and icons of the SIM cards

- Press **Register card** and select a SIM card.
- Press <Change> to change the name and icon of the card.

Activate the Smart dual SIM

- Press **Smart dual SIM** to activate the Smart dual SIM feature.
- Select an option and press <Option> → **Save**.

Using the SOS message feature



Send an SOS message to your family or friends in an emergency.

 <Menu> → **Messages** → **Settings** → **SOS messages**

Activate the SOS message feature

- Press **Sending options** → <Change> and set **Sending SOS to On**.
- Enter recipient and press <Options> → **Save**.
- Set the number of times to repeat the message.
- Press <Back> → <Yes>.

Send an SOS message

- With the keypad locked, press [- To exit SOS mode, press [

Making fake calls

 <Menu> → **Settings** → **Applications** → **Call** → **Fake call**

Activate the fake call feature

Press **Fake call hot key** and set to **On**.

Make a fake call

- Press and hold the Navigation key down.
- With the keys locked, press the Navigation key down four times.



Safety information



This product meets applicable national SAR limits of 2.0 W/kg. The specific maximum SAR values can be found in the SAR information section of this manual.

When carrying the product or using it while worn on your body, maintain a distance of 1.5 cm from the body to ensure compliance with RF exposure requirements.

Trademarks

- SAMSUNG and the SAMSUNG logo are registered trademarks of Samsung Electronics.
- Bluetooth® is a registered trademark of the Bluetooth SIG, Inc. worldwide.
- All other trademarks and copyrights are the property of their respective owners..

This safety information contains content for mobile devices. Some content may be not applicable to your device. To prevent injury to yourself and others or damage to your device, read the safety information about your device before using the device.

Warning: Prevent electric shock, fire, and explosion

Do not use damaged power cords or plugs, or loose electrical sockets

Do not touch the power cord with wet hands or disconnect the charger by pulling the cord

Do not bend or damage the power cord

Do not use your device while it is charging or touch your device with wet hands

Do not short-circuit the charger or the device

Do not drop or cause an impact to the charger or the device

Do not charge the battery with the charger that is not approved by the manufacturer

Do not use your device during a thunderstorm

Your device may malfunction and your risk of electric shock is increased.

Do not handle a damaged or leaking Lithium Ion (Li-Ion) battery

For safe disposal of your Li-Ion battery, contact your nearest authorised service centre.

Handle and dispose of the device and charger with care

- Use only Samsung-approved battery and charger specifically designed for your device. Incompatible battery and charger can cause serious injuries or damage to your device.
- Never dispose of the battery or device in a fire. Follow all local regulations when disposing of used battery or device.
- Never place the battery or device on or in heating devices, such as microwave ovens, stoves, or radiators. The device may explode when overheated.
- Never crush or puncture the device. Avoid exposing the device to high external pressure, which can lead to an internal short circuit and overheating.

Protect the device, battery and charger from damage

- Avoid exposing your device and battery to very cold or very hot temperatures.
- Extreme temperatures can damage the device and reduce the charging capacity and life of your device and battery.
- Prevent the battery from coming into contact with metal objects, as this can create a connection between the + and – terminals of your battery and lead to temporary or permanent battery damage.
- Never use a damaged charger or battery.

Caution: Follow all safety warnings and regulations when using your device in restricted areas

Do not use your device near other electronic devices

Most electronic devices use radio frequency signals. Your device may interfere with other electronic devices.

Do not use your device near a pacemaker

- Avoid using your device within a 15 cm range of a pacemaker, if possible, as your device can interfere with the pacemaker.
- To minimise possible interference with a pacemaker, use your device only on the side of your body that is opposite the pacemaker.

Do not use your device in a hospital or near medical equipment that can be interfered with by radio frequency

If you use medical equipment, contact the equipment manufacturer before using your device to determine whether or not the equipment will be affected by radio frequencies emitted by the device.

If you use a hearing aid, contact the manufacturer for information about radio interference

The radio frequency emitted by your device may interfere with some hearing aids. Before using your device, contact the manufacturer to determine whether or not your hearing aid will be affected by radio frequencies emitted by the device.

Turn off the device in potentially explosive environments

- Turn off your device in potentially explosive environments instead of removing the battery.
- Always comply with regulations, instructions and signs in potentially explosive environments.
- Do not use your device at refuelling points (petrol stations), near fuels or chemicals, or in blasting areas.
- Do not store or carry flammable liquids, gases, or explosive materials in the same compartment as the device, its parts, or accessories.

- Dial sensibly and assess the traffic. Place calls when you are not moving or before pulling into traffic. Try to plan calls when your car will be stationary.
- Do not engage in stressful or emotional conversations that may be distracting. Make the person you are talking to aware that you are driving and suspend conversations that could potentially divert your attention from the road.
- Use your device to call for help. Dial a local emergency number in the case of fire, traffic accidents, or medical emergencies.
- Use your device to help others in emergencies. If you see a car accident, a crime in progress, or a serious emergency where lives are in danger, call a local emergency number.
- Call roadside assistance or a special, non-emergency assistance number when necessary. If you see a broken-down vehicle posing no serious hazard, a broken traffic signal, a minor traffic accident where no one appears injured, or a vehicle that you know to be stolen, call a number that is designated for reporting these types of situations.

Proper care and use of your mobile device

Keep your device dry

- Humidity and liquids may damage the parts or electronic circuits in your device.
- Do not turn on your device if it is wet. If your device is already on, turn it off and remove the battery immediately (if the device will not turn off or you cannot remove the battery, leave it as-is). Then, dry the device with a towel and take it to a service centre.
- Liquids will change the colour of the label that indicates water damage inside the device. Water damage to your device can void your manufacturer's warranty.

Do not disassemble, modify, or repair your device

- Any changes or modifications to your device can void your manufacturer's warranty. If your device needs servicing, take your device to a Samsung Service Centre.
- Do not disassemble or puncture the battery, as this can cause explosion or fire.

Do not paint or put stickers on your device

Paint and stickers can clog moving parts and prevent proper operation. If you are allergic to paint or metal parts of the device, you may experience itching, eczema, or swelling of the skin. When this happens, stop using the device and consult your physician.

When cleaning your device:

- Wipe your device or charger with a towel or an eraser.
- Clean the battery terminals with a cotton ball or a towel.
- Do not use chemicals or detergents.

Do not use the device if the screen is cracked or broken

Broken glass or acrylic could cause injury to your hands and face. Take the device to a Samsung Service Centre to have it repaired.

Do not use the device for anything other than its intended use

Avoid disturbing others when using the device in public

Do not allow children to use your device

Your device is not a toy. Do not allow children to play with it as they could hurt themselves and others or damage the device.

Do not use or store your device in areas with high concentrations of dust or airborne materials

Dust or foreign materials can cause your device to malfunction and may result in fire or electric shock.

Store your device only on flat surfaces

If your device falls, it may be damaged.

Do not store your device in very hot or very cold areas. It is recommended to use your device at temperatures from 5 °C to 35 °C

- Your device can explode if left inside a closed vehicle, as the internal temperature can reach up to 80 °C.
- Do not expose your device to direct sunlight for extended periods of time (on the dashboard of a car, for example).
- Store the battery at temperatures from 0 °C to 45 °C.

Do not store your device with metal objects, such as coins, keys, and necklaces

- Your device may be scratched or may malfunction.
- If the battery terminals come into contact with metal objects, this may cause a fire.

Do not store your device near magnetic fields

- Your device may malfunction or the battery may discharge from exposure to magnetic fields.
- Magnetic stripe cards, including credit cards, phone cards, passbooks, and boarding passes, may be damaged by magnetic fields.
- Do not use carrying cases or accessories with magnetic closures or allow your device to come into contact with magnetic fields for extended periods of time.

Install mobile devices and equipment with caution

- Ensure that any mobile devices or related equipment installed in your vehicle are securely mounted.
- Avoid placing your device and accessories near or in an airbag deployment area. Improperly installed wireless equipment can cause serious injury when airbags inflate rapidly.

Allow only qualified personnel to service your device

Allowing unqualified personnel to service your device may result in damage to your device and will void your manufacturer's warranty.

Handle SIM cards or memory cards with care

- Do not remove a card while the device is transferring or accessing information, as this could result in loss of data and/or damage to the card or device.
- Protect cards from strong shocks, static electricity, and electrical noise from other devices.
- Do not touch gold-coloured contacts or terminals with your fingers or metal objects. If dirty, wipe the card with a soft cloth.

Ensure access to emergency services

Emergency calls from your device may not be possible in some areas or circumstances. Before travelling in remote or undeveloped areas, plan an alternative method of contacting emergency services personnel.

Keep your personal and important data safe

- While using your device, be sure to back up important data. Samsung is not responsible for the loss of any data.
- When disposing of your device, back up all data and then reset your device to prevent misuse of your personal information.

Do not store your device near or in heaters, microwaves, hot cooking equipment, or high pressure containers

- The battery may leak.
- Your device may overheat and cause a fire.

Do not drop your device or cause impacts to your device

- The screen of your device may be damaged.
- If bent or deformed, your device may be damaged or parts may malfunction.

Do not use your device or applications for a while if the device is overheated

Prolonged exposure of your skin to an overheated device may cause low temperature burn symptoms, such as red spots and pigmentation.

If your device has a camera flash or light, do not use it close to the eyes of people or pets

Using a flash close to the eyes may cause temporary loss of vision or damage to the eyes.

Use caution when exposed to flashing lights

- While using your device, leave some lights on in the room and do not hold the screen too close to your eyes.
- Seizures or blackouts can occur when you are exposed to flashing lights while watching videos or playing Flash-based games for extended periods. If you feel any discomfort, stop using the device immediately.

Reduce the risk of repetitive motion injuries

When you repetitively perform actions, such as pressing keys, drawing characters on a touch screen with your fingers, or playing games, you may experience occasional discomfort in your hands, neck, shoulders, or other parts of your body. When using your device for extended periods, hold the device with a relaxed grip, press the keys lightly, and take frequent breaks. If you continue to have discomfort during or after such use, stop using the device and consult a physician.

Ensure maximum battery and charger life

- Avoid charging your device for more than a week, as overcharging may shorten battery life.
- Over time, unused device will discharge and must be recharged before use.
- Disconnect the charger from power sources when not in use.
- Use the battery only for their intended purposes.

Use manufacturer-approved batteries, chargers, accessories, and supplies

- Using generic battery or charger may shorten the life of your device or cause the device to malfunction.
- Samsung cannot be responsible for the user's safety when using accessories or supplies that are not approved by Samsung.

Do not bite or suck the device or the battery

- Doing so may damage the device or cause an explosion.
- If children use the device, make sure that they use the device properly.

Do not insert the device or supplied accessories into the eyes, ears, or mouth

Doing so may cause suffocation or serious injuries.

When using the device:

- Hold the device upright, as you would with a traditional phone.
- Speak directly into the microphone.
- Do not touch the device's internal antenna. Doing so may result in reduced call quality or cause the device to emit unintended levels of radio frequency (RF) energy.

Tests for SAR are conducted using standard operating positions with the device transmitting at its highest certified power level in all tested frequency bands. The highest SAR values under the ICNIRP guidelines for this device model are:

Maximum SAR for this model and conditions under which it was recorded	
Head SAR	0.925 W/kg
Body-worn SAR	0.365 W/kg

During use, the actual SAR values for this device are usually well below the values stated above. This is because, for purposes of system efficiency and to minimise interference on the network, the operating power of your mobile device is automatically decreased when full power is not needed for the call. The lower the power output of the device, the lower its SAR value.

A body-worn SAR test has been performed on this device at a separation distance of 1.5 cm. To meet RF exposure guidelines during body-worn operation, the device must be positioned at least 1.5 cm away from the body.

Organisations such as the World Health Organisation and the US Food and Drug Administration have suggested that if people are concerned and want to reduce their exposure, they could use a hands-free accessory to keep the wireless device away from the head and body during use, or reduce the amount of time spent using the device.

For more information, visit www.samsung.com/sar and search for your device with the model number.

Turn off your device when on an aircraft

Your device may interfere with the aircraft's electronic navigation instruments.

Your device may interfere with automotive equipment

Electronic devices in your car may malfunction, due to radio interference from your device. Contact the manufacturer for more information.

Comply with all safety warnings and regulations regarding mobile device usage while operating a vehicle

While driving, safely operating the vehicle is your first responsibility. Never use your mobile device while driving, if it is prohibited by law. For your safety and the safety of others, use your common sense and remember the following tips:

- Get to know your device and its convenience features, such as speed dial and redial. These features help you reduce the time needed to place or receive calls on your mobile device.
- Position your device within easy reach. Make sure you can access your wireless device without taking your eyes off the road. If you receive an incoming call at an inconvenient time, let your voicemail answer it for you.
- Suspend calls in heavy traffic or hazardous weather conditions. Rain, sleet, snow, ice, and heavy traffic can be hazardous.
- Do not take notes or look up phone numbers. Jotting down a "to do" list or flipping through your address book takes attention away from your primary responsibility of driving safely.

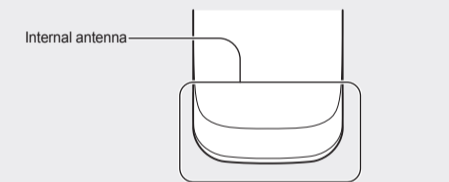

Protect your hearing and ears when using a headset



- Excessive exposure to loud sounds can cause hearing damage.
- Exposure to loud sounds while driving may distract your attention and cause an accident.
- Always turn the volume down before plugging the earphones into an audio source and use only the minimum volume setting necessary to hear your conversation or music.
- In dry environments, static electricity can build up in the headset. Avoid using headsets in dry environments or touch a metal object to discharge static electricity before connecting a headset to the device.

Use caution when using the device while walking or moving

- Always be aware of your surroundings to avoid injury to yourself or others.

- Make sure the headset cable does not become entangled in your arms or on nearby objects.

Do not carry your device in your back pockets or around your waist

You could be injured or damage the device if you fall.

Correct disposal of this product

(Waste Electrical & Electronic Equipment)

 (Applicable in countries with separate collection systems)

This marking on the product, accessories or literature indicates that the product and its electronic accessories (e.g. charger, headset, USB cable) should not be disposed of with other household waste.

 To prevent possible harm to the environment or human health from uncontrolled waste disposal, please separate these items from other types of waste and recycle them responsibly to promote the sustainable reuse of material resources.

Household users should contact either the retailer where they purchased this product, or their local government office, for details of where and how they can take these items for environmentally safe recycling.

Business users should contact their supplier and check the terms and conditions of the purchase contract. This product and its electronic accessories should not be mixed with other commercial wastes for disposal.

This EEE is compliant with RoHS.

Correct disposal of batteries in this product

 (Applicable in countries with separate collection systems)

This marking on the battery, manual or packaging indicates that the batteries in this product should not be disposed of with other household waste. Where marked, the chemical symbols Hg, Cd or Pb indicate that the battery contains mercury, cadmium or lead above the reference levels in EC Directive 2006/66. If batteries are not properly disposed of, these substances can cause harm to human health or the environment.

To protect natural resources and to promote material reuse, please separate batteries from other types of waste and recycle them through your local, free battery return system.

CE 0168