

**SAMSUNG**

# SAMSUNG DOUBLE-DOOR DRAWER REFRIGERATOR INSTRUCTION MANUAL

MODEL:

RL32FCSW

RL32FCSI

RL32FBSW

RL32FBSI

ENGLISH

**SAMSUNG**

## Contact SAMSUNG WORLD WIDE

If you have any questions or comments relating to Samsung products, please contact the SAMSUNG customer care centre.

Country	Customer Care Center ☎	Web Site
SOUTH AFRICA	0860 726 7864 (SAMSUNG)	<a href="http://www.samsung.com/za">www.samsung.com/za</a>

DA68-01271C(14)

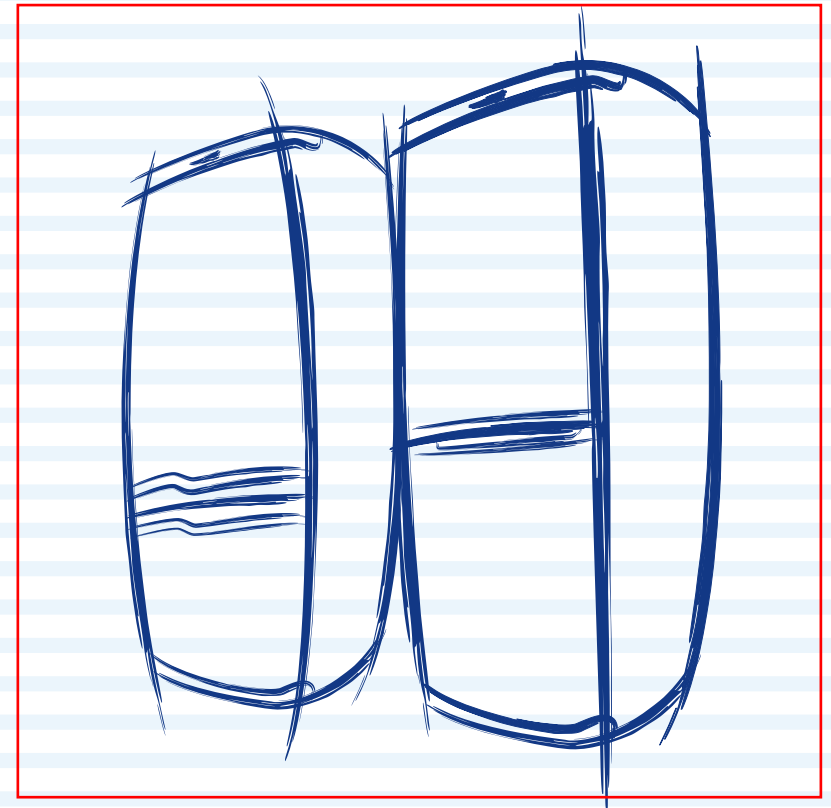

- Please read through this manual before connecting to power and keep it for future reference.
- Any change relating to this manual will result in no additional notice due to continuous improvement made on our products.

Register your product at [www.samsung.com/global/register](http://www.samsung.com/global/register)

Free Standing Appliance

# Contents

PART DESCRIPTIONS .....	1
SAFETY PRECAUTIONS.....	2
INTRODUCTION TO CONTROL PANEL.....	2
SETTINGS.....	3
PREPARATIONS BEFORE USE.....	4
DISASSEMBLING MEANS.....	5
WARNING IN USE.....	6
STORING FOOD.....	7
HOW TO USE.....	8
MAINTENANCE & CLEANING.....	9
TROUBLE SHOOTING.....	10

☛ *Please read this manual carefully for right use.*

☛ *Please read all the precautions included in this manual prior to use.*

☛ *Please retain this manual properly for future reference.*

## FEATURES

- ☞ Digital mode: external control and indications of work status and inner temperature.
- ☞ Deodorization: clean up the odor inside and refraining germ growing.
- ☞ Fluorine-free environmental Protection: green product protecting the environment.
- ☞ Reliable performance: The sealed and high-powered name-brand compressor gives out excellent performance and high reliability.
- ☞ Reasonable layout: the storage-up and freezing-down structure can retain the cool air by less power consumption. The frequently used refrigerator room is designed upside for convenient handling. Its shelf may vary with the container size.
- ☞ Odor retention: the freezer was draw-structured to retain pure smell by preventing odor from escaping.
- ☞ Flat back: the built-in condenser gives easy access to cleaning.

## ACCESSORIES

Model	Name	Tray fre	Shelf ref	Fruit&vegetable tray	Tray cover	Egg guard	Egg tray	Ice tray	Wire bar	Cheese tray	Bottle guard
RL32FCSW											
RL32FCSI		3	3	1	1	2	1	1	1	1	1
RL32FBSW											
RL32FBSI											

## DESCRIPTIONS OF LOCATIONS(demonstration based on RL32FBSW)

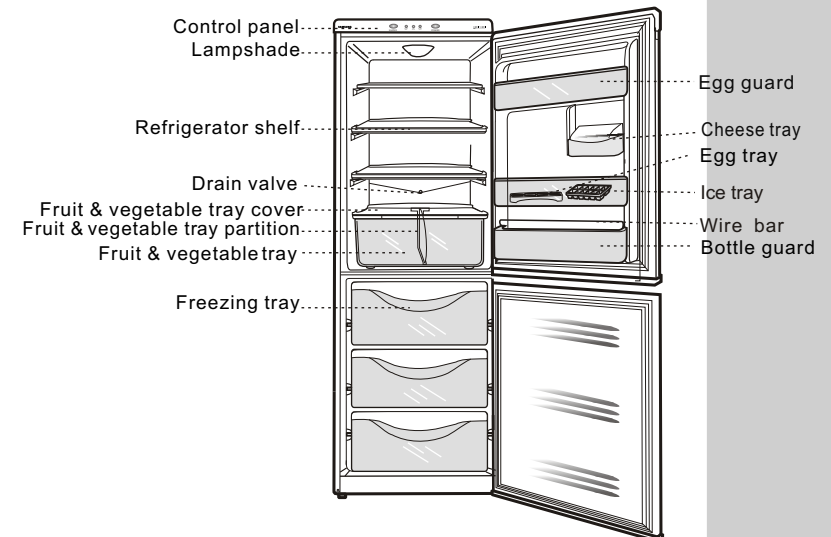

## SAFETY PRECAUTIONS

### Children Warning

The glass shelves movable, please alert the children staying away to avoid unnecessary hurt as it is heavy.

### Read Instructions

Before initiating the power, make sure to read all the safety and operating instructions in this manual.

### Keep Instructions

Please keep this manual properly for future reference.

### Heed Warning

Please follow all instructions on the refrigerator and this manual.

### Follow the instructions of this manual in practice.

### All procedures and instructions should be adhered to during operation.

Please refer to the Model and Serial Number for your unit.

This manual includes four similar models of RL32FCSW, RL32FCSI, RL32FBSW, RL32FBSI, where RL32FBSW is dominated by descriptions.  
Date purchased: \_\_\_\_\_  
Model No.: \_\_\_\_\_  
Serial: \_\_\_\_\_

## INSTRUCTIONS ON MECHANICAL REFRIGERATOR DISPLAY PANEL

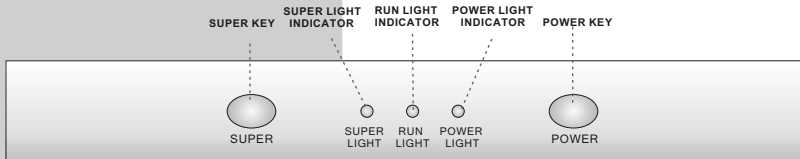

If you need to freeze large amount of food stuff, set the temperature of freezer compartment as the coldest temperature before you turn on the Super Cool key button.

### Display unit

1. When power is on, press the power key to activate the power light to initiate the appliance.
2. If super is necessary, then press the super key to activate the super light. If this function is not required, repress the super key to turn off the super light. Otherwise, the appliance will keep working.
3. When super is cancelled, repeat action is not recommended within 5 minutes.
4. Power key, super key shall not be pressed frequently in succession. The interval between each action shall be above 5 minutes to protect the compressor.
5. The appliance is not suitable for long super action (super light on). It must be recovered from the super state within 3 hours as the refrigerator temperature will drops under 0°C due to long super action.

### Bicker is heard.

- It's the sound arising from refrigeration agent when it flows.
- It is not malfunction.

### Dew is found in the fruit and vegetable room.

- It occurs when the door is open for a long time.
- The fluid food is not sealed.

### The water result from frost thaws floods in the refrigerator.

- The drainage outlet is blocked.
- Dredge up the drain-hose with drainage plug or similar aids.

### When the freezing function is not adequate.

- The door is not shut properly.
- The door seal is damaged or deformed.
- The refrigerator is laid near heat resource and exposed in the sunlight.
- The refrigerator is stuffy inside.

### Long time running takes place

- Hot in summer.
- The door is opened and closed frequently.
- The food is put near the temperature sensor.
- The ventilation outside of the unit is in bad situation.

### Dew appears on the inner bottom and frame.

- The environment is too moist
- Not a trouble, just dry it by soft cloth.

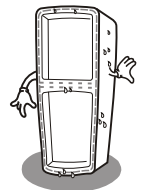
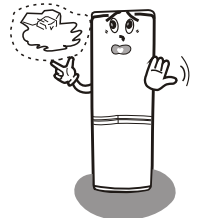
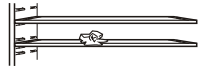
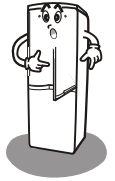
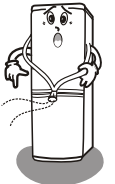

## TROUBLE SHOOTING

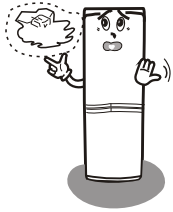

### Refrigerator stops working

- The plug is connected improperly

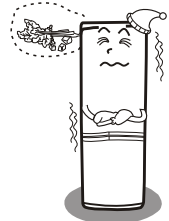

### The foodstuff of the refrigerator is frosted

- Temperature setting is too low.
- The food stored is in contact with the cold source of the back wall.
- The refrigerator is in the state of deepfreeze.

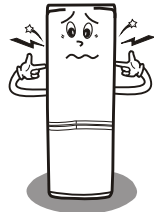

### Refrigerator omits noise

- The inner items are not evenly placed.
- The refrigerator is installed unevenly.
- The unit is located too close to wall.
- The external refrigerating pipe is in collision with each other or with the unit wall.
- There are foreign objects behind or under the unit.
- The noise is generated during compressor operation.

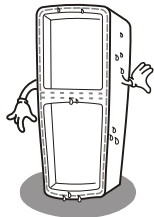

### The front or side wall grows hot

- For the sake of restraining water steam from condensing on the unit frame, the frame is embedded with dew proof pipe that will heat during the unit operation. It is not a problem.
- In both sides of the refrigerator was fitted with devices to drive off heat (condenser).

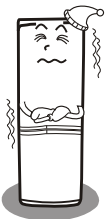

### There are frost arises on the refrigerator wall.

- It's a normal condition when the machine works.
- The frost will vanish automatically when the machine stops running.

## SETTINGS

- The refrigerator should be placed on the flat and firm floor. In case of any unevenness, regulate the adjustable foot under the body to level the refrigerator (counterclockwise means rising). There is an opening under the adjustable foot for you to adjust the height just using some simple tools like cross screwdriver.

- Leave at least 55mm between the unit back and the wall and allow 300mm or more above.

- The refrigerator shall be away from hot resource and direct sunlight.

- Don't place the refrigerator in moisture as the metal parts will get rust and impair the insulation effects. In the event of natural disasters (such as rainstorm, accidents), the submerged unit shall not be put into use until nominated SAMSUNG service center repairs it and proves that it is in good condition.

- Ground properly for personal safety. The refrigerator shall not be grounded via phone wire or gas pipe.

- Don't press the power cord.

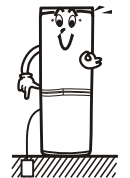
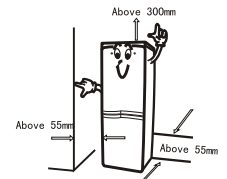
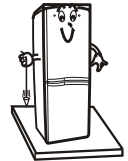

## PREPARATIONS BEFORE USE

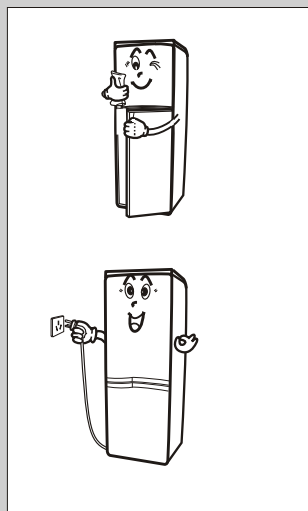

- ✦ Remove the four sponge tapes from the glass compartment shelf, assemble the shelf correctly and embed the protuberance at both sides to the grooves to fix them properly.
- ✦ Clean the inner and outer of the unit using warm and wet cloth (some detergent is allowed in the warm water)
- ✦ Initiate the power one-hour later and watch the refrigerator top. If deepfreeze is needed, press the deepfreeze button to activate the deepfreeze function indicated by the indicator. If deepfreeze is not required within 3 hours, then repress the deepfreeze button, and the deepfreeze indicator will go off, meaning that the unit has exited the deepfreeze status. In case that the deepfreeze function is not cancelled manually, the unit will quit automatically after 3 hours. Then store the foodstuff 2-3 hours later.

### Caution:

- ✦ After using the freezer, don't forget to shut the drawer before closing the door.
- ✦ Before connecting to the power, please check whether the power voltage is in permission. The rated voltage is 187-242V. If your power voltage is in discrepancy, an automatic voltage transformer above 500W shall be necessary. You can get the suitable products from the market.

Suggestion: As for the need of storing vast food, making ice or expediting cold air, you may draw out the tray and frost the food directly on the evaporator shelf.

## MAINTENANCE & CLEANING

- ✦ **Interior parts**  
Dismantle all shelves, bars, trays, covers and drawers, and clean with a warm damp cloth wiper.
- ✦ **Door gasket**  
Clean door gasket with care. Wipe the recessed place with chopstick wrapped with cotton strip.
- ✦ **Water tray**  
Screw off the screw in the compressor cover, pull up the water tray lightly and draw it out. Fix it as before after washing.
- ✦ **Defrost approach**  
Thick frost layer depositing on the interior wall will affect refrigeration effects. On that account, you may cut off the power after taking out the foods and placing somewhere in good package. Wipe off the water soil with a soft cloth when the frost layer thaws. Afterwards, switch on the power and restart the machine to reset the temperature.

### Cautions:

- Never place the refrigerator upside down and horizontally. If titling is required, the angle between compartment body and the ground shall be at least 45° .
- In the initial use, remove the four sponge tapes from the glass shelf and fit the shelf. Embed the protuberance at both sides to the grooves to fix them properly.
- Never move the refrigerator by door handle or impose large force on the handle up and down.
- The intervals between plug pulling and plugging shall be more than 5 minutes.

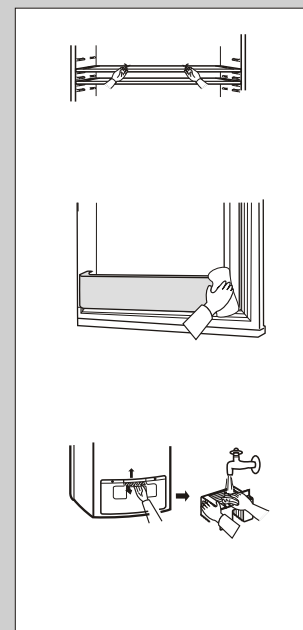

## MECHANICAL TEMPERATURE ADJUSTMENT

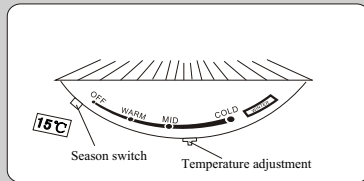

The temperature is adjusted by the slide under the control of temperature controller. The signs WARM, MID and COLD, on the knob receptively indicate the inside temperature condition. Under the same circumstance, stronger the knob reflects, lower the inside temperature is. OFF means stopping working.

In normal use, adjust the slide at the MID and change it to the location between WARM and MID if any hot weather. If the room temperature is below 15 °C, then open the season switch and change the slide to the location between MID and COLD. If the room temperature is below 10 °C, it's a must to locate the slide at the WINTER area.

## FRUIT AND VEGETABLE COMPARTMENT

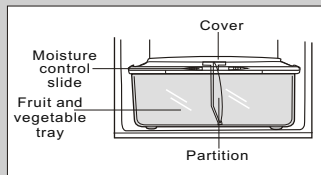

You may adjust the moisture of the fruit and vegetable compartment by the moisture control slide. The slide towards the two sides may increase the moisture, vice versa.

The partition of the fruit and vegetable tray separates the fruit and vegetable compartment into two parts. You are allowed to adjust it according to the fruit and vegetable types and quantities to meet a satisfactory need of storage space.

The fruit and vegetable compartment is able to preserve the water content and freshness of the fruits and vegetables as it is sealed to prevent cold air touching the fruits and vegetables. It is appropriate to the storage of vegetables and fruits.

### Caution:

Tropical fruits, such as banana and pineapple are not recommended.

## DISASSEMBLING PARTS

### Refrigerator shelf

Draw out it till the block, lift the shelf rear and pull it out.  
(position the shelf as per the container's height)

### Fruit and vegetable tray and cover

Pull out the fruit and vegetable tray.  
Drive up the cover head and put it out.

### Freezer tray

Draw out it till the block, lift the shelf rear and pull it out.

### Egg guard and bottle guard

Lift them up to dismantle it.  
The wire bar of the bottle guard may vary as per requirement.

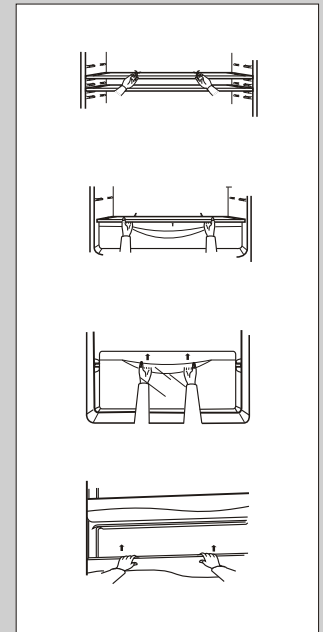

## REPLACE OF BUILT-IN LIGHT

Pull out the plug  
Turn off the screw in the lampshade back, press the center by fingers and push back to take out the lampshade.

Turn off the bulb counterclockwise.

Screw on the bulb clockwise.  
Hang on the hook under the cover and turn upward to push into the upper hook.

Lamp parameter: 220V/240V, 15W

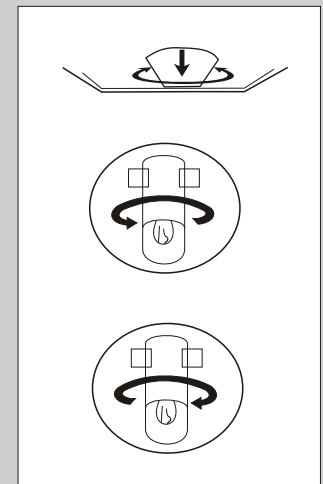

## WARNING IN USE

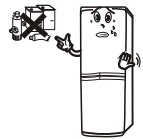
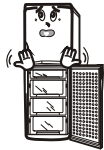
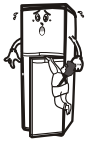
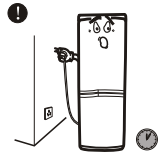

- ⚠ **Cautions:** Damaged power cords should be replaced by the manufacturer nominated service outlets, as special tools are required.

The power cut-off should not be reconnected within 5 minutes to prevent the compressor being damaged.

- ⚠ Never use the combustible sprays like lacquer and paint near the machine for those will cause blasting hazard.

**Caution:** Do not use the unit outdoors or in the rain.

- ⚠ Don't let children play with or hang on the unit, as this will damage the unit or hurt children.

- ⚠ Most importantly, open the door neither for a long time nor frequently in hot quarter, as the effects of the sets will be impaired with increasing workload. Don't put foodstuff near the warm sensor to ensure the temperature displays correctly.

- ⚠ Neither store inflammable, explosive items, strong acid and alkali corrosive items, such as butane, ether, benzene, sulfuric acid, gas, alcohol and so on, nor put the bottled fluid food in the freezer as the bottle might crack.

- ⚠ When the refrigerator works in malfunction, or is damaged, operation shall be stopped immediately. Cut off the power and call the local service center. Damaged power cord should be replaced by the manufacturer representatives or the personnel with same qualification.

- ⚠ Do not splash the water to the unit back as this will impair the insulation.

### Caution:

A wet hand is forbidden to touch the frost shelf evaporator as the water remains will ice up and stick to the evaporator.

## STORING FOODS

- ⚠ Pack the foods with freshness reserving bags (films) or seal the food container with a lid to prevent drying or bad odor escaping.

- ⚠ Hot food and drink should be cooled to the room temperature before putting into the refrigerator.

- ⚠ The cooked and raw foods shall be placed separately.

- ⚠ The foods shall not be placed too tightly to leave sufficient space for circulation of cool air.

- ⚠ Store foods in smaller portions.

- ⚠ Dry the fruits and vegetables for storage after washing.

- ⚠ Fruits and vegetables shall be placed in the fruit and vegetable room to retain their water content and freshness.

(Caution: Tropical fruits, such as banana and pineapple are not recommended.)

