

SAMSUNG

**THREE-CD CHANGER
MINI-COMPACT SYSTEM
MP3-CD/WMA-CD/CD-R/RW
PLAYBACK**

MAX-X55/X56/X57

MAX-X65/X66

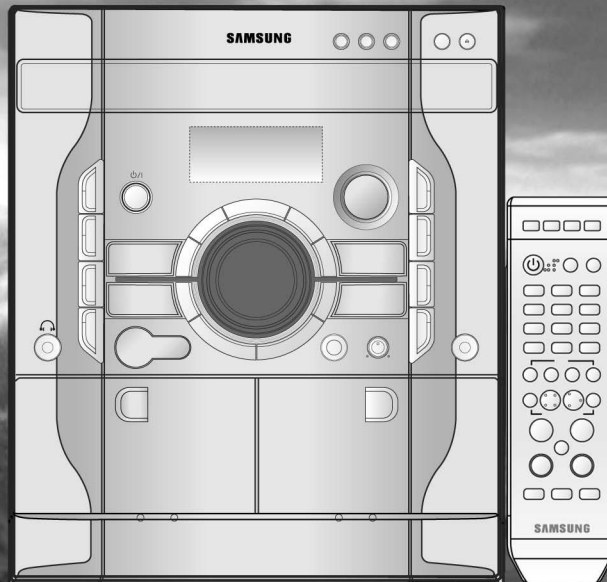

Instruction Manual



Safety Warnings

GB

**CLASS 1 LASER PRODUCT
KLASSE 1 LASER PRODUKT
LUOKAN 1 LASER LAITE
KLASS 1 LASER APPARAT
PRODUCTO LASER CLASE 1**

	CAUTION RISK OF ELECTRIC SHOCK. DO NOT OPEN	
CAUTION: TO REDUCE THE RISK OF ELECTRIC SHOCK, DO NOT REMOVE REAR COVER. NO USER SERVICEABLE PARTS INSIDE. REFER SERVICING TO QUALIFIED SERVICE PERSONNEL.		

CLASS 1 LASER PRODUCT

This Compact Disc player is classified as a CLASS 1 LASER product.

Use of controls, adjustments or performance of procedures other than those specified herein may result in hazardous radiation exposure.

CAUTION-INVISIBLE LASER RADIATION WHEN OPEN AND INTERLOCKS DEFEATED, AVOID EXPOSURE TO BEAM.



This symbol indicates that dangerous voltage which can cause electric shock is present inside this unit.



This symbol alerts you to important operating and maintenance instructions accompanying the unit.

WARNING: To reduce the risk of fire or electric shock, do not expose this appliance to rain or moisture.

CAUTION: TO PREVENT ELECTRIC SHOCK, MATCH WIDE BLADE OF PLUG TO WIDE SLOT, FULLY INSERT.

(Saudi Arabian Standards Organisation)

THIS APPLIANCE IS FITTED WITH 220V SASO APPROVED PLUG.THE CUSTOMER IS ENTITLED TO A FREE SASO APPROVED 127V PLUG FROM THE LOCAL DEALER.

Contents

Thank you for buying this
SAMSUNG mini-compact system.

Please take time to read these instructions.
They will allow you to operate your
system with ease and take full advantage
of its features.



◆ SAFETY WARNINGS	2
◆ INSTALLING YOUR MINI-COMPACT SYSTEM	
■ Front Panel View(MAX-X55/X56/X57)	4
■ Rear Panel View (MAX-X55).....	4
■ Rear Panel View (MAX-X56/X57)	5
■ Remote Control(MAX-X55/X56/X57).....	5
■ Front Panel View(MAX-X65/X66)	6
■ Rear Panel View (MAX-X65).....	6
■ Rear Panel View (MAX-X66).....	7
■ Remote Control(MAX-X65/X66)	7
■ Where to Install Your Mini-Compact System.....	8
■ Connecting your System to the Power Supply	8
■ Inserting Remote Control Batteries	8
■ Connecting the Loudspeakers	8
■ Connecting to an External Source	9
■ Connecting the AM (MW) Aerial	9
■ Connecting the FM Aerial	9
■ Demo/Dimmer function	10
■ Setting the Clock	10
◆ CDMP3/WMA-CD-PLAYER	
■ Loading and Changing Compact Discs.....	11
■ To replay the CD/MP3/WMA-CD	11
■ Selecting a CD in the Disc changer	12
■ Selecting a Track.....	12
■ To select the MP3/WMA-CD title and track	12
■ Searching for a Specific Music Passage on a CD	13
■ Shuffle Play Function	13
■ Repeating One or All Tracks on the Compact Discs.....	14
■ Function to skip through 10 track at a time	14
■ Last Memory Function	14
■ Programming the Order of CD Playback	15
■ Checking or Changing Programmed CD Tracks.....	16
◆ TUNER	
■ Searching for and Storing the Radio Stations	17
■ Selecting a Stored Station.....	18
■ Improving Radio Reception	18
◆ TAPE DECK	
■ Listening to a Cassette	19
■ CD Synchro Record Feature.....	19
■ Recording a Compact Disc	19
■ Recording a Radio Program	20
■ Copying a Cassette (Dubbing)	20
■ Tape Counter	20
■ Selecting the Cassette Playback Mode(only for MAX-X65/X66)	20
◆ OTHER FUNCTIONS	
■ Timer Function	21
■ Cancelling the Timer	21
■ Mute Function	22
■ Selecting Sound Mode.....	22
■ Power Sound Function	22
■ Setting the System to Switch off Automatically	23
■ Connecting Headphones.....	23
■ Microphone Function(option).....	23
◆ RECOMMENDATIONS FOR USE	
■ Safety Precautions	24
■ Cleaning Your Mini-Compact System	24
■ Precautions When Using Compact Discs	25
■ Precautions When Using Audio Cassettes	25
■ Before Contacting the After-Sales Service	25
■ Technical Specifications	26



Press



Push

Symbols



Important



Note

Front Panel View(MAX-X55/X56/X57)

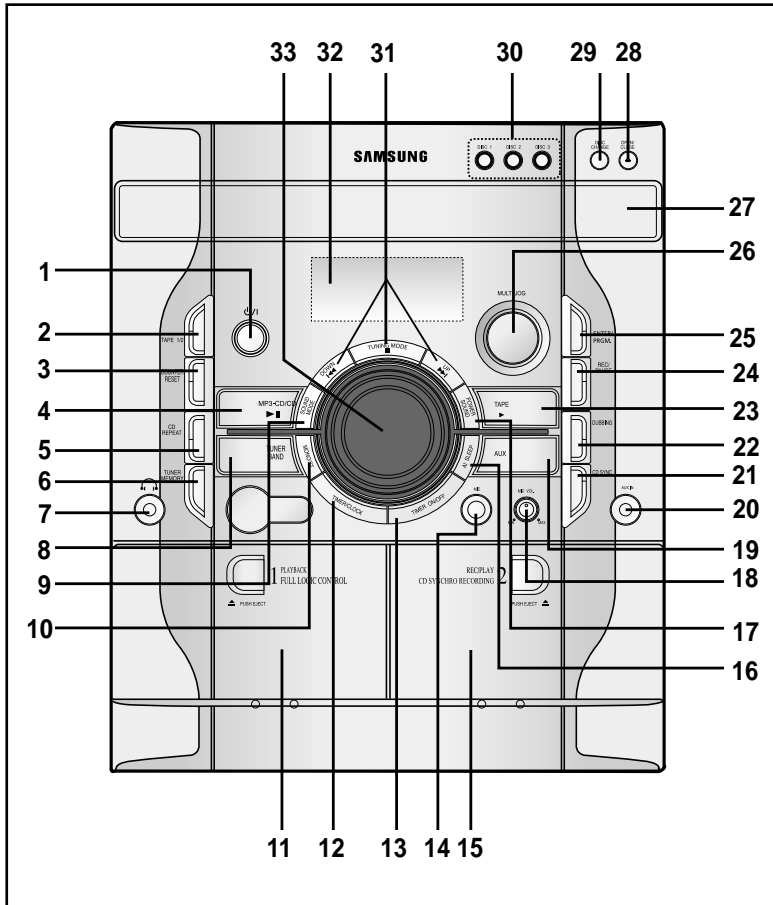

1. STANDBY/ON
2. TAPE 1/2
3. TAPE COUNTER RESET
4. MP3-CD/CD FUNCTION
5. CD REPEAT
6. TUNER MEMORY
7. HEADPHONE JACK CONNECTOR
8. TUNER BAND FUNCTION
9. SOUND MODE
10. FM MONO/STEREO
11. CASSETTE DECK 1
12. TIMER/CLOCK
13. TIMER ON/OFF
14. MIC(OPTION)
15. CASSETTE DECK 2
16. AI SLEEP
17. POWER SOUND
18. MIC VOL.
19. AUX
20. AUX IN
21. CD SYNCHRO RECORDING
22. DUBBING
23. TAPE FUNCTION
24. REC/PAUSE
25. ENTER/PROGRAM
26. MULTI JOG
27. COMPACT DISC COMPARTMENT
28. CD OPEN/CLOSE
29. CD DISC CHANGE
30. CD DISC SELECTION BUTTONS
31. SEARCH FUNCTION BUTTONS
32. TUNING MODE OR STOP BUTTON
33. WINDOW DISPLAY
33. VOLUME CONTROL

Rear Panel View (MAX-X55)

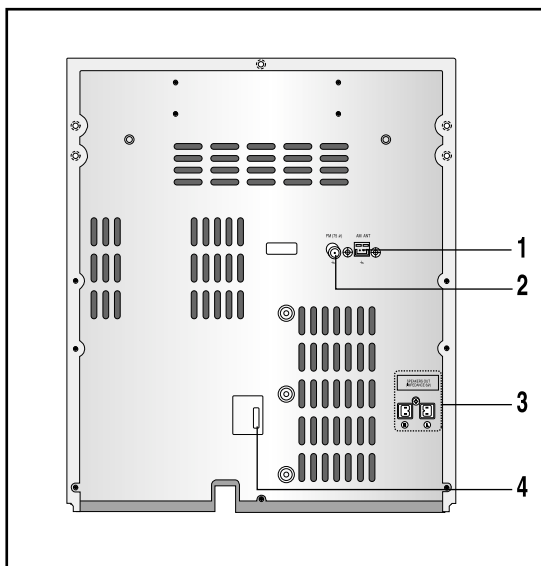

1. AM Aerial Connector Terminals
2. FM Aerial Connector Terminal
3. Speaker Connector Terminals
4. Voltage Selector(option)

Rear Panel View (MAX-X56/X57)

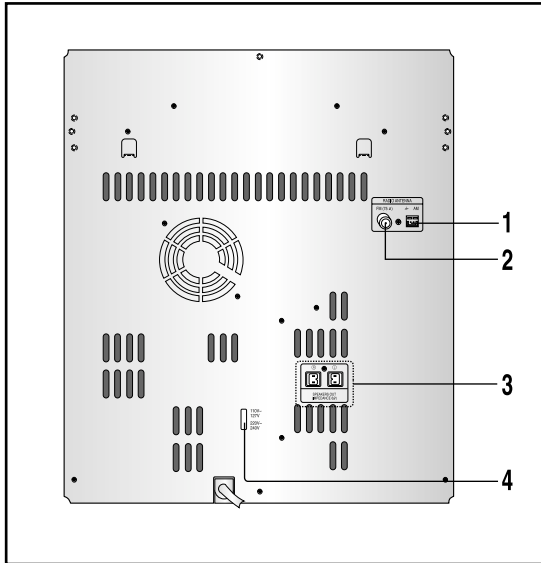

1. AM Aerial Connector Terminals
2. FM Aerial Connector Terminal
3. Speaker Connector Terminals
4. Voltage Selector(option)

☞ All those pictures of Front panel, Rear panel and remote control are based on MODEL:MAX-X56

Remote Control(MAX-X55/X56/X57)

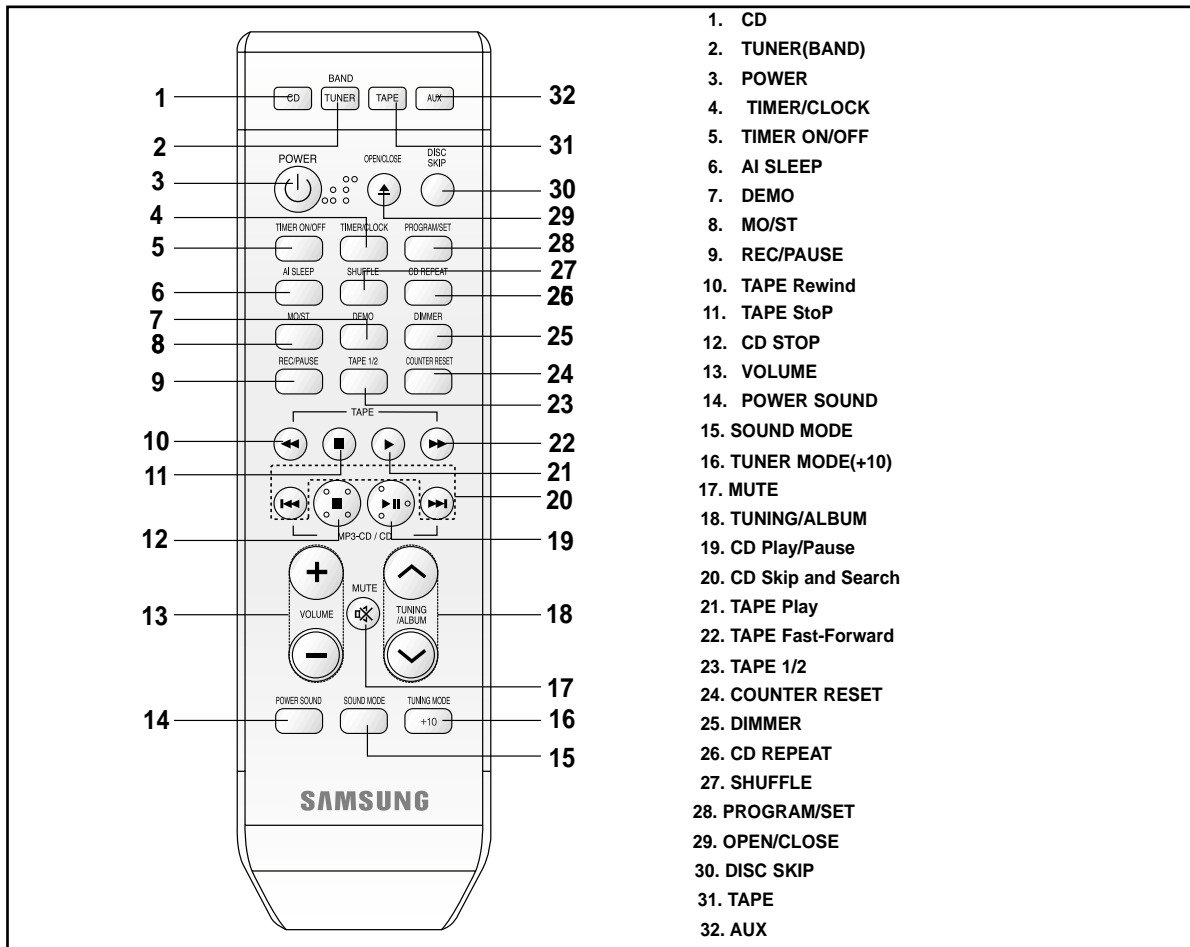

1. CD
2. TUNER(BAND)
3. POWER
4. TIMER/CLOCK
5. TIMER ON/OFF
6. AI SLEEP
7. DEMO
8. MO/ST
9. REC/PAUSE
10. TAPE Rewind
11. TAPE StoP
12. CD STOP
13. VOLUME
14. POWER SOUND
15. SOUND MODE
16. TUNER MODE(+10)
17. MUTE
18. TUNING/ALBUM
19. CD Play/Pause
20. CD Skip and Search
21. TAPE Play
22. TAPE Fast-Forward
23. TAPE 1/2
24. COUNTER RESET
25. DIMMER
26. CD REPEAT
27. SHUFFLE
28. PROGRAM/SET
29. OPEN/CLOSE
30. DISC SKIP
31. TAPE
32. AUX

Front Panel View(MAX-X65/X66)

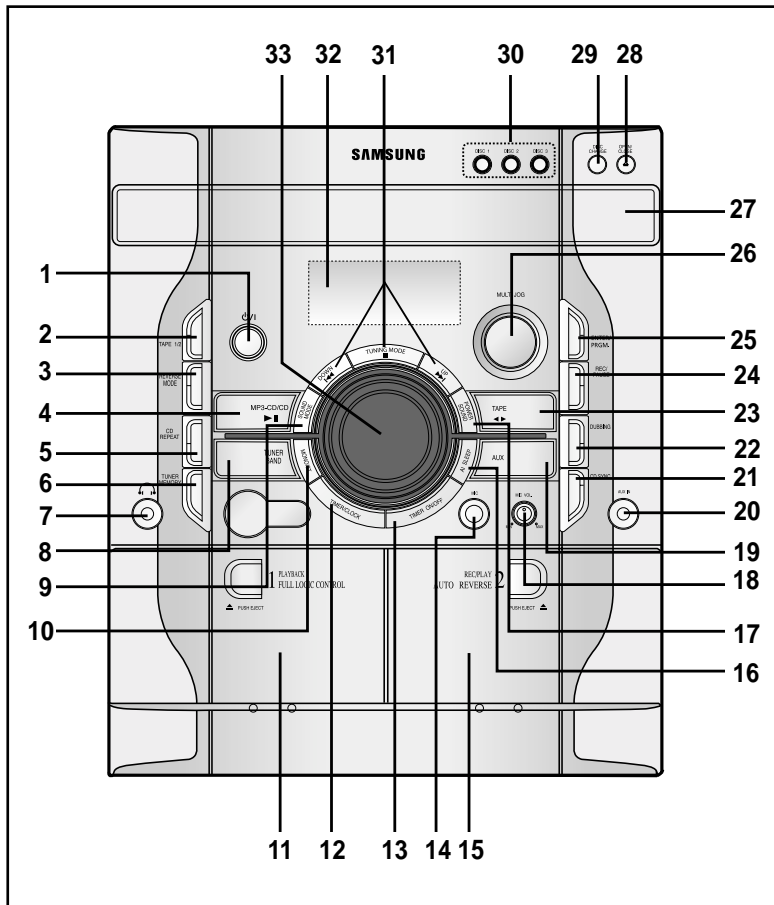

1. STANDBY/ON
2. TAPE 1/2
3. TAPE REVERSE MODE
4. MP3-CD/CD FUNCTION
5. CD REPEAT
6. TUNER MEMORY
7. HEADPHONE JACK CONNECTOR
8. TUNER BAND FUNCTION
9. SOUND MODE
10. FM MONO/STEREO
11. CASSETTE DECK 1
12. TIMER/CLOCK
13. TIMER ON/OFF
14. MIC(OPTION)
15. CASSETTE DECK 2
16. AI SLEEP
17. POWER SOUND
18. MIC VOL.
19. AUX
20. AUX IN
21. CD SYNCHRO RECORDING
22. DUBBING
23. TAPE FUNCTION
24. REC/PAUSE
25. ENTER/PROGRAM
26. MULTI JOG
27. COMPACT DISC COMPARTMENT
28. CD OPEN/CLOSE
29. CD DISC CHANGE
30. CD DISC SELECTION BUTTONS
31. SEARCH FUNCTION BUTTONS
32. TUNING MODE OR STOP BUTTON
33. WINDOW DISPLAY

Rear Panel View (MAX-X65)

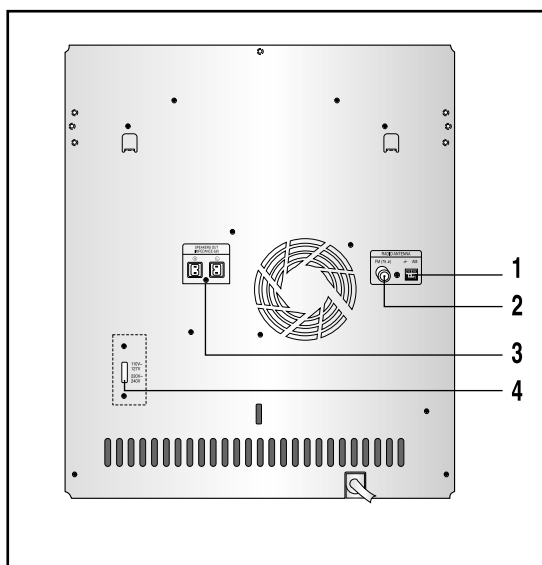

1. AM Aerial Connector Terminals
2. FM Aerial Connector Terminal
3. Speaker Connector Terminals
4. Voltage Selector(option)

Rear Panel View (MAX-X66)

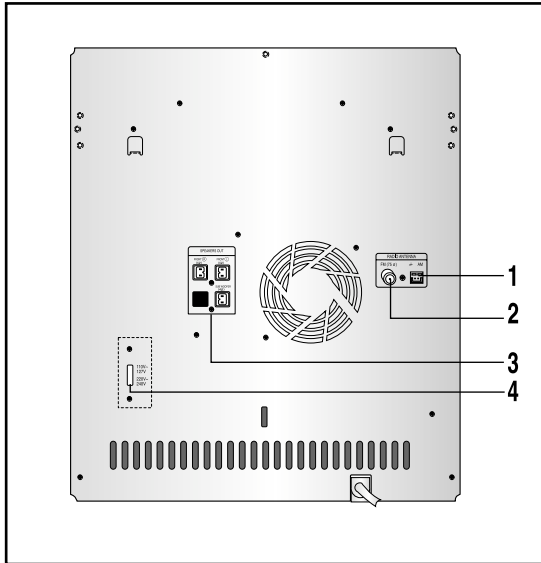

1. AM Aerial Connector Terminals
2. FM Aerial Connector Terminal
3. Speaker Connector Terminals
4. Voltage Selector(option)

Remote Control(MAX-X65/X66)

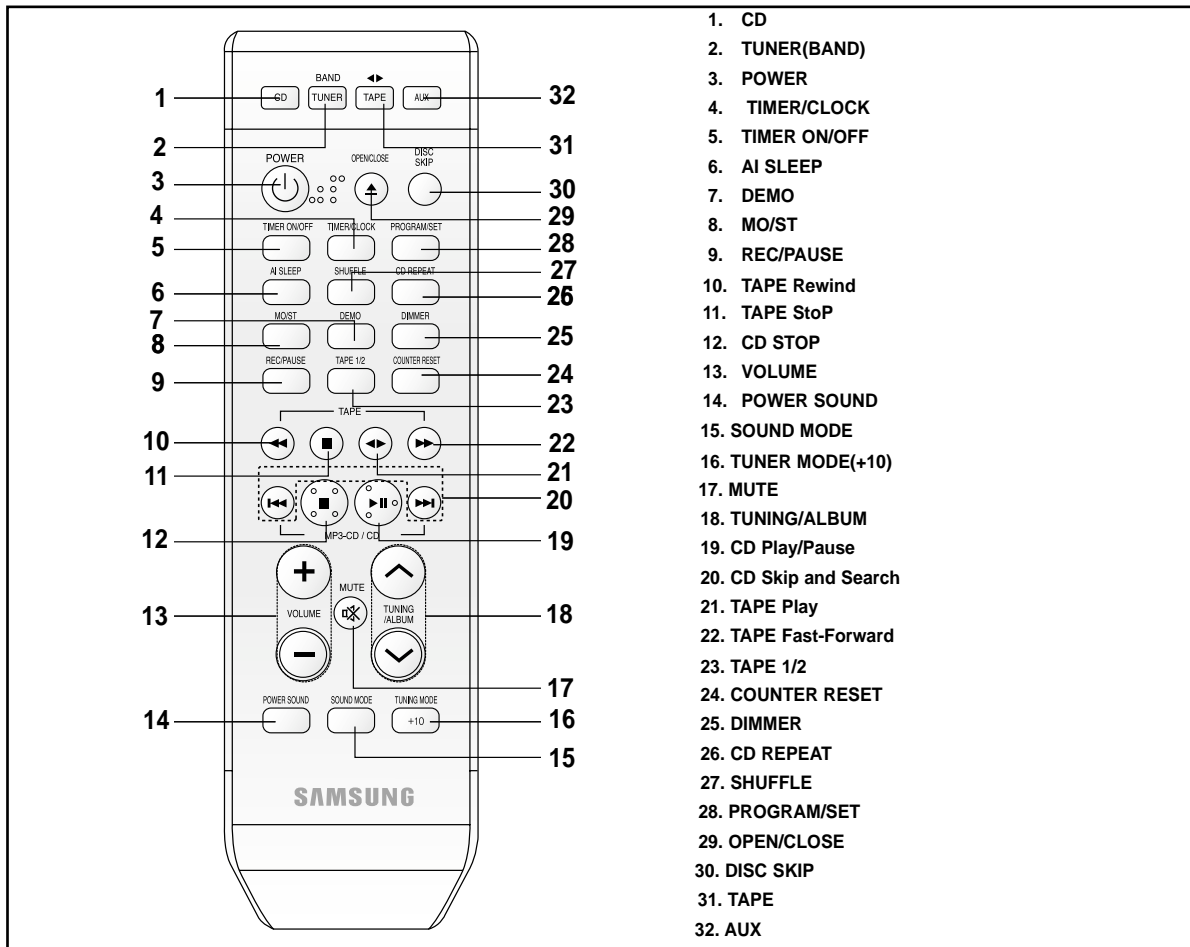

1. CD
2. TUNER(BAND)
3. POWER
4. TIMER/CLOCK
5. TIMER ON/OFF
6. AI SLEEP
7. DEMO
8. MO/ST
9. REC/PAUSE
10. TAPE Rewind
11. TAPE StoP
12. CD STOP
13. VOLUME
14. POWER SOUND
15. SOUND MODE
16. TUNER MODE(+10)
17. MUTE
18. TUNING/ALBUM
19. CD Play/Pause
20. CD Skip and Search
21. TAPE Play
22. TAPE Fast-Forward
23. TAPE 1/2
24. COUNTER RESET
25. DIMMER
26. CD REPEAT
27. SHUFFLE
28. PROGRAM/SET
29. OPEN/CLOSE
30. DISC SKIP
31. TAPE
32. AUX

Where to Install Your Mini-Compact System

GB

To take full advantage of your new mini-compact system, follow these installation instructions before connecting the unit.

- ◆ Install the system on a flat, stable surface.
- ◆ Never place this unit on carpeting.
- ◆ Never place this unit in an outdoor area.
- ◆ Maintain an open space of approximately 6 inches (15 cm) on the sides and rear of the system, for ventilation purposes.
- ◆ Make sure that you have enough room to open the compact disc compartment easily.
- ◆ Place the loudspeakers at a reasonable distance on either side of the system to ensure good stereo sound.
- ◆ Direct the loudspeakers towards the listening area.
- ◆ For optimum performance, make sure that both speakers are placed at an equal distance above the floor.

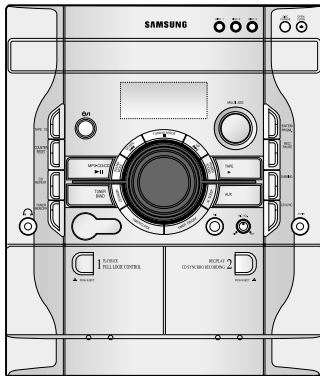

Connecting your System to the Power Supply

Before plugging your system into a main socket, you must check the voltage.

- 1 Check the position of the voltage selector on the rear of the system (OPTIONAL).
- 2 Plug the main lead into an appropriate socket.
- 3 Press the ϕ (STANDBY/ON) button to switch your mini-compact system.

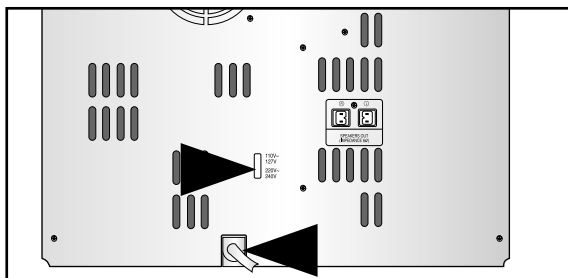

Inserting Remote Control Batteries

Insert or replace remote control batteries when you:

- ◆ Purchase the mini-compact system
 - ◆ Find that the remote control is no longer operating correctly
- When replacing the batteries, use a new set of batteries and never mix alkaline and manganese batteries.

- 1 Place your thumb on the position marked \blacktriangleright on the battery compartment cover (rear of the remote control) and pull the cover in the direction of the arrow.
- 2 Insert two AAA, LR03 or equivalent batteries, taking care to respect the polarities:
 - ◆ + on the battery against + in the battery compartment
 - ◆ - on the battery against - in the battery compartment
- 3 Replace the cover by sliding it back until it clicks into position.

If you will not be using the remote control for a long time, remove the batteries to prevent corrosion.

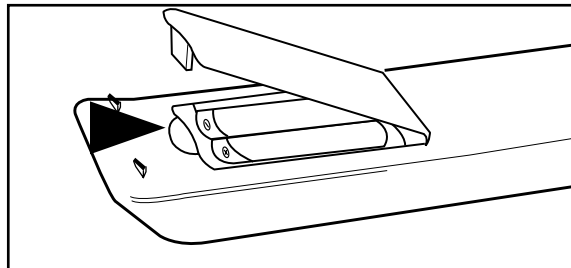

Connecting the Loudspeakers

The loudspeaker connector terminals are located on the rear of the system.

There are two terminals on the system:

- ◆ left speaker (marked L)
- ◆ right speaker (marked R)

To achieve the correct sound quality, insert those speaker connector cables to the speaker connector terminals of the system.

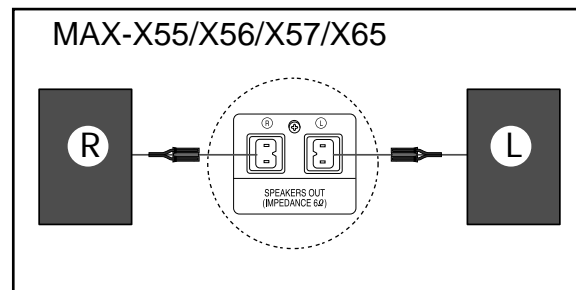

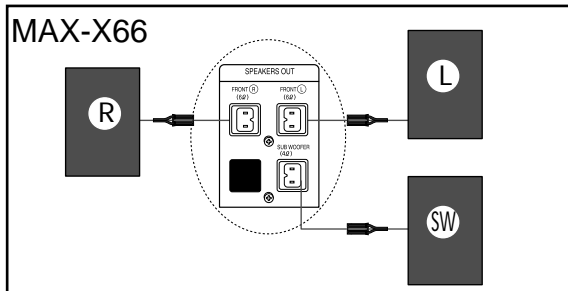

Connecting to an External Source

The auxiliary input can be used to take advantage of the sound quality of your mini-compact system when listening to other sources.

- Examples:
- ◆ A television
 - ◆ A video disc player
 - ◆ A Hi-Fi stereo video cassette recorder

➤ To connect to the external source, the source must have an audio output. In addition, you need a connection cable.

- 1** Set the system to standby mode and disconnect it and the external source from the main socket.
- 2** Connect AUX In on the MINI-COMPACT to Audio Out on the external analog component.
 - Be sure to match connector colors.
- 3** Plug the system back into the main socket and press **STANDBY/ON** to switch it on.
- 4** Select the AUX source by pressing **AUX**.
Result: **AUX** is displayed.
- 5** Switch the external source on.
- 6** Adjust the volume and balance as required:
 - ◆ Volume
 - ◆ Equalizer

Example: You can watch a film and take advantage of stereo sound provided that the original sound track is in stereo (as if you were in a cinema).

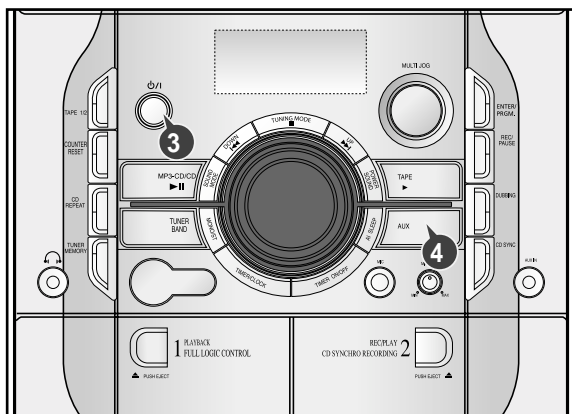

Connecting the AM (MW) Aerial

The AM aerial can be:

- ◆ Placed on a stable surface
- ◆ Fixed to the wall (you must first remove the base)

The AM aerial connector terminals are located on the rear of the system and are marked **AM**.

➤ To avoid noise interference, check that the loudspeaker wires do not run close to the aerial wires. Always keep them at least 2 inches (5 cm) away.

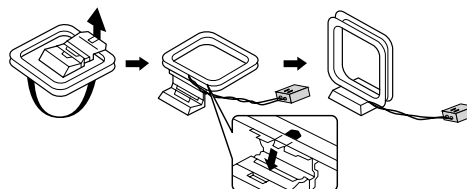
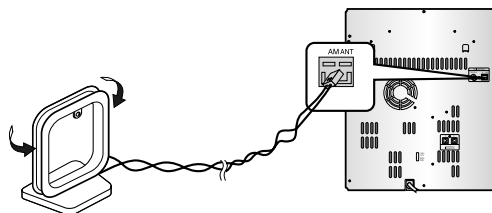

Connecting the FM Aerial

How to connect a **COAXIAL TYPE** aerial.

- ◆ Connect a 75Ω antenna to the **FM** antenna terminal.
- ◆ Plug the connector on the FM aerial supplied into the coaxial socket (75Ω) marked **FM** on the rear of the system.
- ◆ Follow the instructions given on **Page 17** to tune into a radio station, and determine the best position for the aerial.
- ◆ If reception is poor, you may need to install an outdoor aerial. To do so, connect an outdoor FM aerial to the **FM** socket on the rear of the system using a 75Ω coaxial cable (not supplied).

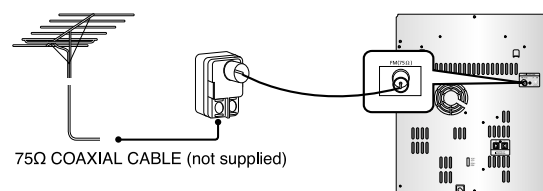
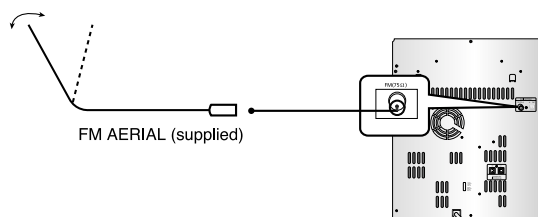

DEMO/DIMMER function

GB

All functions available on the system can be viewed on the display and the display's brightness can be switched between "on" and "off".

- 1 Press the **DEMO** button.
Result: All functions available on the system appear on the front panel display.
- Each of these are explained in detail in this guide. Please refer to the relevant section.
- 2 Press the **DIMMER** button.
Result: The Dimmer function is selected and the display darkens.
- 3 Press the **DIMMER** button once again to brighten the front panel display.
- A display brightness control can only be performed while the system power is on.

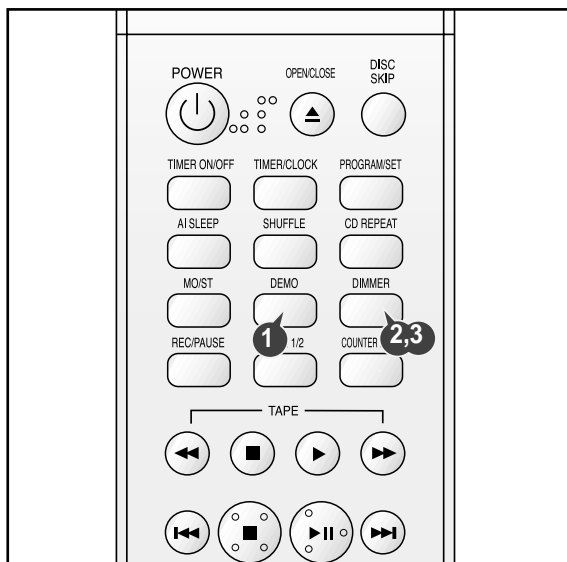

Setting the Clock

Your system is equipped with a clock which allows you to turn your system on and off automatically.

You should set the clock:

- ◆ When you first purchase the mini-compact system
- ◆ After a power failure
- ◆ After unplugging the unit
- ◆ For each step, you have a few seconds to set the required options. If you exceed this time, you must start again.

- 1 Switch the system on by pressing **STANDBY/ON**.
- 2 Press **TIMER/CLOCK** twice.
Result: **CLOCK** is displayed.
- 3 Press **ENTER/PRGM..**
Result: The hour flashes.
- 4 To... Turn the **MULTI JOG** knob to the...
Increase the hours Right
Decrease the hours Left
- 5 When the correct hour is displayed, press **ENTER/PRGM..**
Result: The minutes flash.
- 6 To... Turn the **MULTI JOG** knob to the...
Increase the minutes Right
Decrease the minutes Left
- 7 When the correct time is displayed, press **ENTER/PRGM..**
Result: The clock starts and is displayed, even when the system is in standby mode.

- ◆ You can display the time, even when you are using another function, by pressing **TIMER/CLOCK** once.
- ◆ You can also use **◀ / ▶** buttons on the panel front or **TUNING** \vee / \wedge on the remote control to instead of **MULTI JOG** knob in step 4, 6.

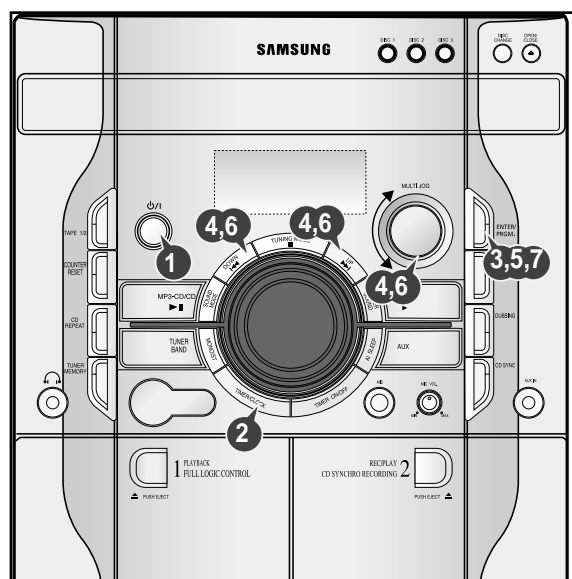

Loading and Changing Compact Discs

The CD disc changer can contain up to three 12 cm or 8 cm compact discs without using an adapter.

- ⚠ Never force the compact disc carousel when opening and closing the compartment.
Never press down or place objects on the carousel.
- Always treat your compact discs with care; refer, if necessary, to the section entitled "Precautions When Using Compact Discs" on page 25 .

- 1 Switch the system on by pressing **STANDBY/ON**.
- 2 Press the **OPEN/CLOSE** (▲) button on the front panel.
Result: The compartment opens.
- 3 Place one disc in the front slots of the carousel, with the label on the discs facing upwards.
⚠ Check that the compact disc has been correctly inserted in the holder before closing the compartment.
- 4 If you wish to load another compact disc, press the **DISC CHANGE** button on the front panel (or **DISC SKIP** on the remote control).
Result: The carousel rotates by 120°.
- 5 Close the compartment by pressing the **OPEN/CLOSE** (▲) button again.
➤ If you wish to start playing a disc directly, you can also proceed as follows.

To play...	Press...
Disc 1	MP3-CD /CD (▶) or Disc 1
Disc 2	Disc 2
Disc 3	Disc 3

Result: The compartment closes automatically and the disc selected starts playing.

- 6 To change or unload the compact disc changer, repeat Steps 2 to 5.

- ⚠ Keep the compartment closed whenever you are not using it, to prevent dust from entering.
- You can load or unload compact discs when the radio, tape or auxiliary source function is selected.

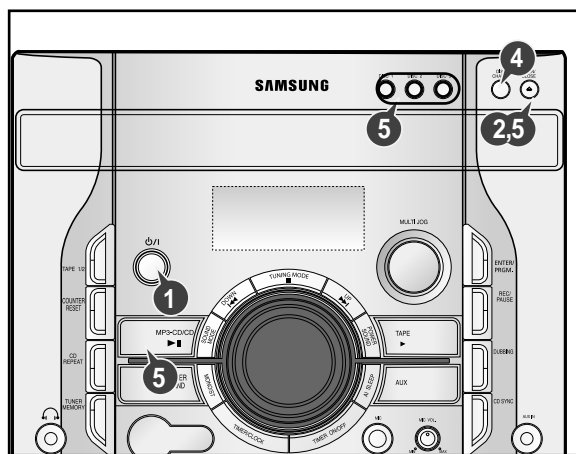

To replay the CD/MP3/WMA-CD

This is a player that enables the playback of audio CD, CD-R, CD-RW and MP3/WMA-CD and does not possess the function that saves MP3 files.

Do not use CDs of irregular shapes like heart or octagon shapes. The performance of the player may be degraded. At least more than one CD should be inserted for playbacks.

- 1 Press the **STANDBY/ON** button to switch on the power.
- 2 Press the **MP3-CD/CD** (▶ ||) of the main unit to select the CD function.
- 3 Insert more than one CD, or a MP3/WMA-CD .
- 4 Press the **MP3-CD/CD** (▶ ||) button of the main unit or the ▶ || button of the remote control.
➤
 - ◆ If there are more than one CD or an MP3/WMA-CD inserted, replays are then processed in order.
 - ◆ Your CD Player will take a few moments to scan through all the tracks recorded on a particular MP3/WMA-CD.
 - ◆ The English name of the song may be indicated on the display only if directly downloaded from the PC or if the purchased MP3/WMA-CD is sorted according to titles(directory). (Other languages besides English may not be indicated.)
 - ◆ The English name of the track may not be indicated depending on the characteristics of the MP3/WMA-CD.

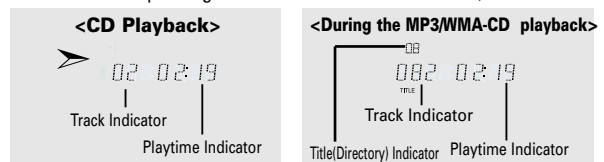

- 5 Adjust the volume according to needs with the following procedures.
◆ Press the **VOLUME +** or **-** button of the remote control.
The volume level can be adjust in 31 steps(VOL MIN,VOL 1-VOL 29,and VOL MAX).
- 6 If it is desired to pause while the playback is processing, press the **MP3-CD/CD** (▶ ||) button.
➤ Press the **MP3-CD/CD** (▶ ||) button once again to playback again.
- 7 To stop playback, press the ■ button.

- ◆ A new disc may be inserted in the remaining two compartments excluding the CD which is being played back. Press the **Disc Changer** button to open the CD tray. The revolving part does not turn during playbacks.
- ◆ If there is not even one CD inserted in the CD tray, it is indicated as "NO DISC".
- ◆ If the CD Repeat function is not selected, 3 CDs are played back which automatically stops.
- ◆ The quality of MP3/WMA-CD playback may vary depending on the condition of the disc containing the music files or the condition of the recorder with which the disc was created.
- ◆ If different types of files or unnecessary folders are on the same disc,you will have problems with playback.

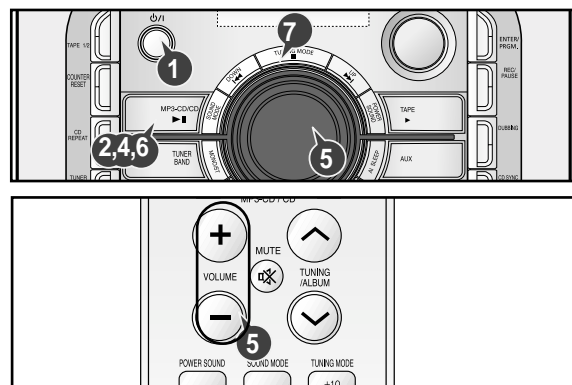

GB

Ⓢ

Selecting a CD in the Disc changer

GB

The CD function is automatically selected when Disc Skip is pushed.

To select a specific disc, press the corresponding **DISC (1, 2, 3)** button on the front panel or **DISC SKIP** on the remote control, until the required disc indicator flashes.

Result: starting with the one selected.

- If you wish to play the current disc only, press **CD REPEAT** on the front panel one or more times, until **1 CD** is displayed.
- ♦ If you use the **DISC (1, 2, 3)** function when listening to the radio or to a tape, the system switches automatically to the CD mode.
- ♦ If the disc selected is not loaded, the next disc is played automatically.
- ♦ When the CD door is opened, if you hold the **OPEN/CLOSE** button over 5 seconds until "LOCK" is on the display, the CD door will be locked. In the case, you should hold the **OPEN/CLOSE** button once again until "UNLOCK" is on the display, the CD door will be unlocked.

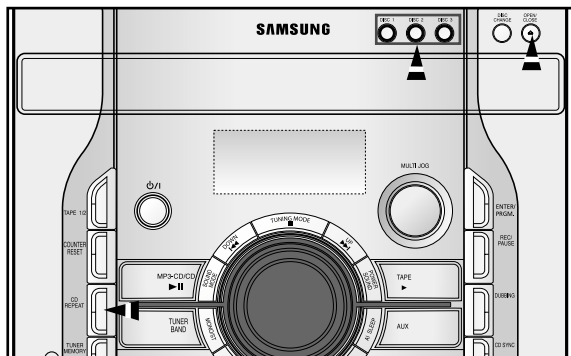

Selecting a Track

You can select the track you wish to listen to, either when the compact disc player is stopped or when a disc is playing.

To start playback at the beginning of the... Turn the MULTI JOG knob...

Next track	One notch to the right
Current track	One notch to the left
Previous track	Two notches to the left
Track of your choice	The appropriate number of notches to the right or to the left

- ♦ You can also use the **◀▶** and **▶▶** buttons on the front panel, or the **◀▶** and **▶▶** buttons on the remote control to select a track.



To select the MP3/WMA-CD title and track

The title and track of the MP3/WMA-CD desired to listen may be selected on stopping or during playbacks.

Main Unit

To move the title(Album), Turn the Multi Jog Knob.

To move the track, press the **◀▶** button.

- ♦ Moves the track within the title.
- ♦ If the **◀▶** button is pressed more than the number of tracks within the title, it moves to the next title.

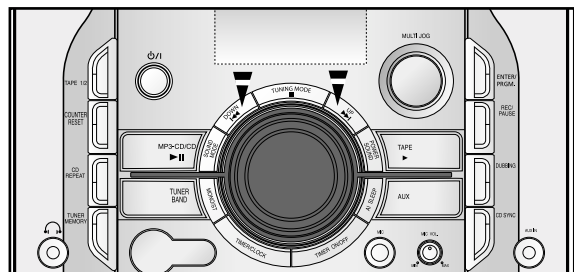

Remote Control

Press the **TUNING/ALBUM** **∨** or **∧** button, the title moves.
Press the **◀▶** or **▶▶** buttons, the track moves.

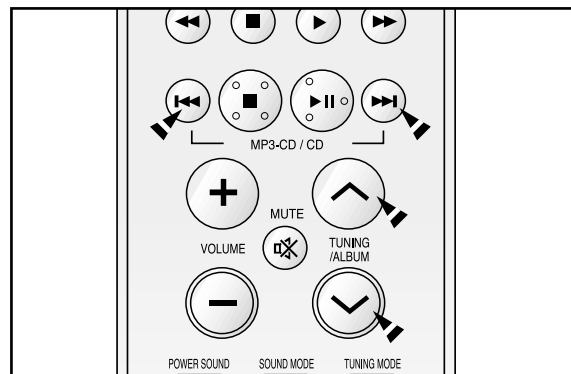

What is WMA?

WMA means Windows Media Audio, the global standard for audio signal compression technology.

What is MP3?

MP3 means MPEG1 Layer 3, the global standard for audio signal compression technology. It uses digital compression technology to compress original sound data by up to 12 times without sound quality degradation.

File Compatibility

- ◆ The unit will playback files created in MP3 format (Mpeg1.Layer3) with *.mp3 as their extension, and some WMA files with.WMA extension can't be playback.
- ◆ Playback will be impossible for the file of MP2 or 22KHz.
- ◆ ID3*tags can be shown on the display in English.
- *An MP3 file can contain file information called "ID3 Tag " where its album name, performer, rack title, etc. are recorded.

How many MP3 files can a CD-R or CD-RW disc record?

The maximum capacity of one CD-R or CD-RW disc is 680MB.

Normally, one MP3 file has a capacity of 4MB, therefore approximately 170 files can be recorded on a single disc.

Regarding the playback of CD-R/RW

- ◆ In the case of an original CD-R(Recordable) recorded in audio CD format, CD-RW(Rewritable) and editing by the user, playback is processed on the respective completed status. (The player may not be played back according to the characteristics of the CD or recorded status.)
- ◆ The CD-RW is comparably less reflexive than CD which causes more time delay to read.

Playback sequence of titles and tracks

- ◆ In case of Window Explorer display.
- ◆ The arrows indicate playback sequence of titles and tracks.
- ◆ Tracks with jpg, wav or doc only are not audio files and therefore will be skipped.

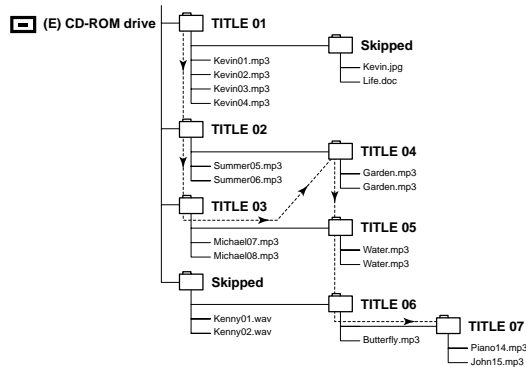

Searching for a Specific Music Passage on a CD

When listening to a compact disc, you can quickly search for a specific music passage on a track.

- It is recommended that you turn the volume down before using this function.

To search through the tracks...	Press and hold down...
Forwards	▶▶ for at least one second
Backwards	◀◀ for at least one second

You can also press and hold down ◀▶ / ▶▶ on the front panel to auto search through the tracks.

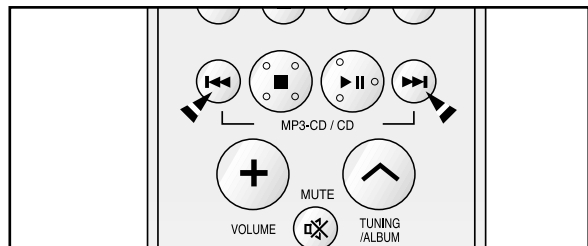

Shuffle Play Function

- 1 Press the **SHUFFLE** button.
Result: The SHUFFLE (CD) indication appears and all the tracks are played in a random order. Both the track number and the playing time are displayed.
- 2 When playing tracks in a random order, you can:
 - ◆ Move on to the next track (selected at random) by pressing ◀▶/▶▶ or turning **MULTI JOG** one notch to the left or right.
 - ◆ Search quickly for a specific point in the current track by holding ◀▶/▶▶ more than one second.
- 3 To finish the random playback, press ■ or press the **SHUFFLE** button again.

- Repeat and CD Synchro function are not available in Shuffle playing mode.

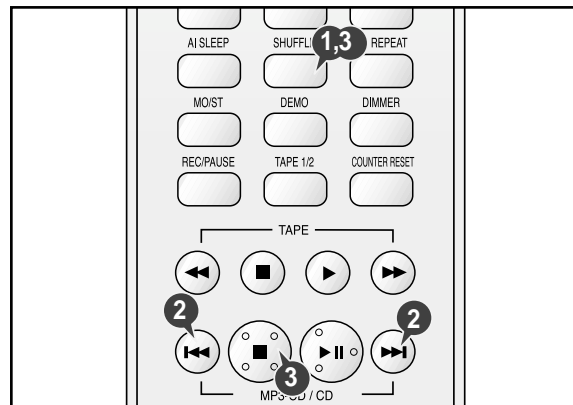

Repeating One or All Tracks on the Compact Discs

GB

You can repeat indefinitely:

- ◆ A specific track on a compact disc.
- ◆ All tracks on the compact disc selected.
- ◆ All discs loaded in the carousel

- 1** To repeat... Press **CD REPEAT** on the Remote control once or more times until...

The current track indefinitely **REPEAT 1** is displayed
 The selected disc **REPEAT 1 CD** is displayed
 All discs loaded **REPEAT ALL CD** is displayed

- 2** When you wish to stop the Repeat function, press **CD REPEAT** until **ALL CD** or **1 CD** is displayed, or press **■**.

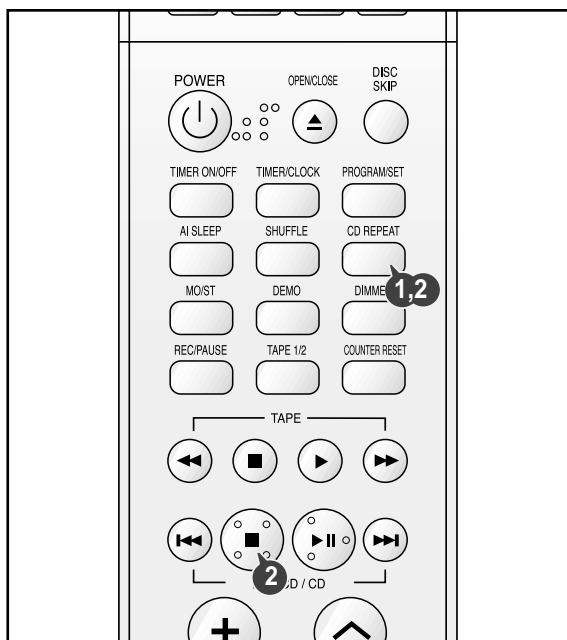

Function to skip through 10 tracks at a time

Press the **+10** button briefly while playing back a **CD** and **MP3/WMA-CD**. The track 10 tracks after the current one will then be played back.

Example: If you want to select track 43 during playback of track 5, press the **+10** button four times, and then press the **▶▶** button three times.

5 → 10 → 20 → 30 → 40 → 41 → 42 → 43

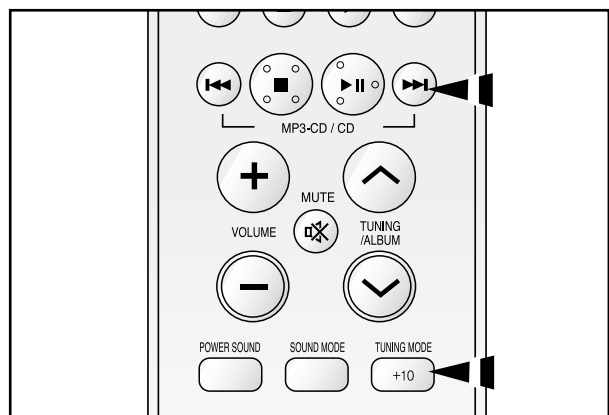

Last Memory Function

(This function is only available during playback of MP3/WMA-CD.)

When **MP3/WMA-CD** playback is selected again after your **CD** player has been stopped or turned off, this function allows playback from the start of the track that you last listened to.

- ◆ Press the **PROGRAM/SET** button while your MP3/WMA-CD is being played. The **LAST ON** and **LAST OFF** may be repeatedly selected.

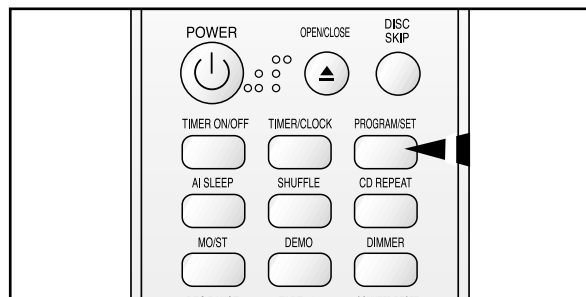

Programming the Order of CD Playback



You can decide:

- ◆ The order in which you listen to the tracks on the discs loaded
- ◆ Which tracks you do not wish to listen to
- ◆ You can program up to 24 tracks.
 - ◆ You must stop the compact disc player before selecting the tracks.
 - ◆ This feature can be combined with the Repeat function.

1 If the CD function is selected, stop the player by pressing ■ .

2 Load the selected CDs.

3 Press **ENTER/PRGM.**
 Result: The following indications are displayed:

01 PRGM
 PR1 --

(01 = Program no., PR1 = Disc no., -- = Track no. on the disc)

4 If necessary, select the disc containing the required track by pressing the corresponding **DISC (1, 2, 3)** button.

5 Select the required track by turning the **MULTI JOG** knob:

- ◆ To the left to move back through the tracks
- ◆ To the right to move forward through the tracks

6 Press **ENTER/PRGM.** to confirm your selection.

Result: The selection is stored and 02 PRGM
 PR1 -- is displayed.

7 To select other tracks, repeat Steps 4 to 6.

8 Press **MP3-CD/CD (▶||)** to listen to the track selection in the order programmed.

9 To... Turn the **MULTI JOG** knob...

Listen to the current track again	One notch to the left
Listen to the previous track	Two notches to the left
Listen to the next track	One notch to the right
Skip forwards or backwards one	The appropriate number of notches to the right or to the left

10 To cancel the selection, press ■ .

- ◆ Once if the compact disc player is stopped
 Result: press ■ again, **PRGM** is no longer displayed.
- ◆ If you open the compartment, the selection is cancelled.
- ◆ If you select the number of a disc which is not loaded or a track which does not exist on the CD, the selection skips to the next programmed track.
- ◆ You can also use the ◀◀/ ▶▶ buttons to select the required tracks in step 5, 9.

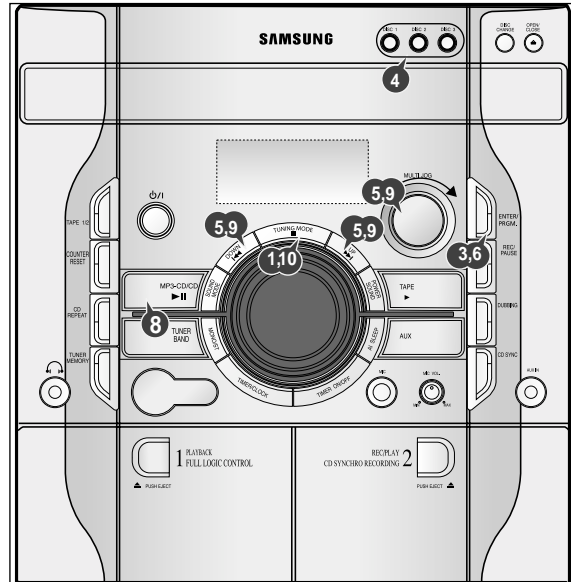

Checking or Changing Programmed CD Tracks

GB

You can check or change your selection of tracks at any time.

- 1 Press **■** once if you have started listening to the selection.
- 2 Press **ENTER/PRGM.**
Result: The following indications are displayed:

(CH = Check, 01=Program No, CH1 = Disc No, -- = Track No on the disc)

 - If you have already programmed 24 tracks, **CH** is displayed instead of **PR** when you press **ENTER/PRGM.**
- 3 Press **ENTER/PRGM.** once or more times until the track to be changed is displayed.
- 4 If necessary, press the corresponding **Disc (1, 2, 3)** button to change discs.
- 5 Press **◀◀** and **▶▶** or turn **MULTI JOG** to select a different track.
- 6 Press **ENTER/PRGM.** to confirm your change.
- 7 Press **MP3/CD-CD (▶||)** to start listening to the selection.
Result: The first track selected is played.

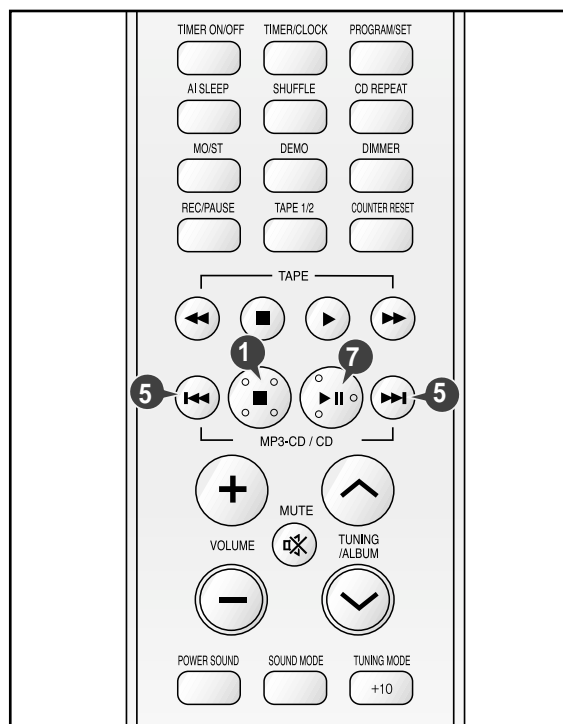
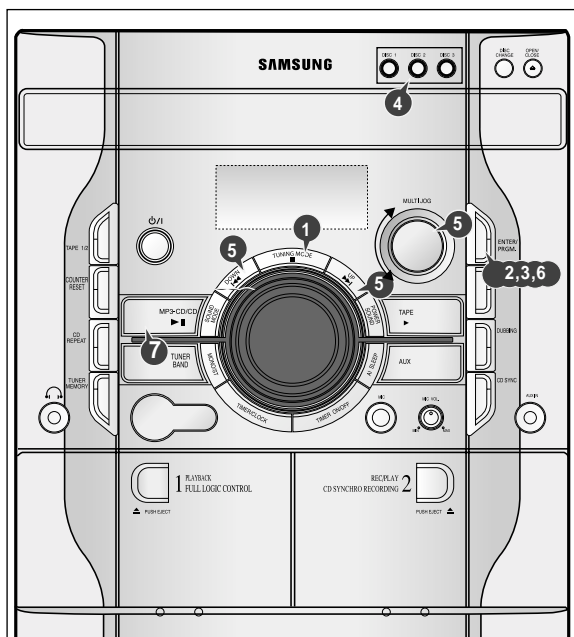

Searching for and Storing the Radio Stations

You can store up to:

- ◆ 15 FM stations
- ◆ 15 AM stations

- 1** Switch the system on by pressing **STANDBY/ON**.
- 2** Select the **TUNER** function by pressing **TUNER BAND**.
- 3** Select the required frequency band by pressing **TUNER BAND** again on the front panel or **TUNER (BAND)** on the remote control.
Result: The appropriate indication is displayed:
 - ◆ **FM** Frequency Modulation
 - ◆ **AM(MW)** Medium Wave

4 To search for a station... Press **TUNING MODE**

Manually	Once or more times until MANUAL is displayed.
Automatically	Once or more times until AUTO is displayed.

- 5** Select the station to be stored by:
 - ◆ Turning the **MULTI JOG** knob to the right or to the left to increase or decrease the frequency respectively
 - or
 - ◆ Pressing **TUNING/ALBUM** ∇ or \blacktriangle on the remote control
 - ◆ To scroll through the frequencies faster when searching manually, hold down the \lll or \ggg buttons.
 - ◆ The automatic search procedure may stop on a frequency that does not correspond to a radio station. If this happens, use the manual search mode.
- 6** Adjust the volume by:
 - ◆ Turning the **VOLUME** knob on the front panel
 - or
 - ◆ Pressing the **VOLUME +** or **-** buttons on the remote control
- 7** Select the FM stereo or mono mode by pressing **MONO/ST**.
- 8** If you do not want to store the radio station found, revert to Step 4 and search for another station.
Otherwise:
 - a** Press **TUNER MEMORY**.
Result: The **PRGM** is displayed for a few seconds.
 - b** Press \lll or \ggg to assign a program number .
 - c** Press **TUNER MEMORY** to store the radio station.
Result: **PRGM** is no longer flashed and the station is stored.
- 9** To store any other radio frequencies required, repeat Steps 3 to 8.

- ◆ The **PROGRAM** function can be used to assign a new station to an existing program number.

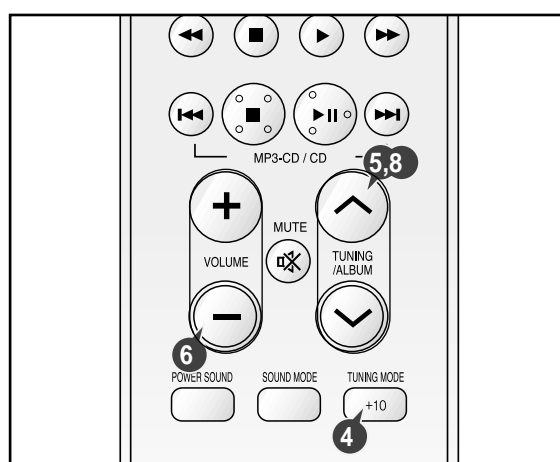
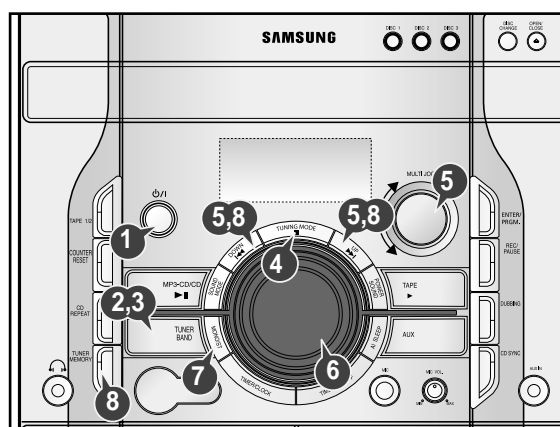

In Tuner mode

- ◆ In manual tuning mode, you can use **MULTI JOG** or \lll / \ggg button on the panel front to manual search a radio station.
- ◆ During Tuner auto searching, press \blacksquare button to stop auto searching.
- ◆ In Preset tuning mode, you can use **MULTI JOG** or \lll / \ggg button on the panel front to search a stored radio station.

Selecting a Stored Station

GB

You can listen to a stored radio station as follows:

- 1 Switch the system on by pressing **STANDBY/ON**.
- 2 Select the **TUNER** function by pressing **TUNER (BAND)** on remote control.
- 3 Select the required frequency band by pressing **TUNER (BAND)** on the remote control or **TUNER BAND** again on the front panel.
- 4 Press the **TUNING MODE** button on the remote control or on the front panel until **"PRESET"** is displayed.
- 5 Turning **MULTI JOG** on the front panel left or right until the desired station is found or press **◀▶** to select the desired station.
or
Select the desired station by pressing the **TUNING** **∨** or **∧** button on the remote control.
Result: The desired station is now received.

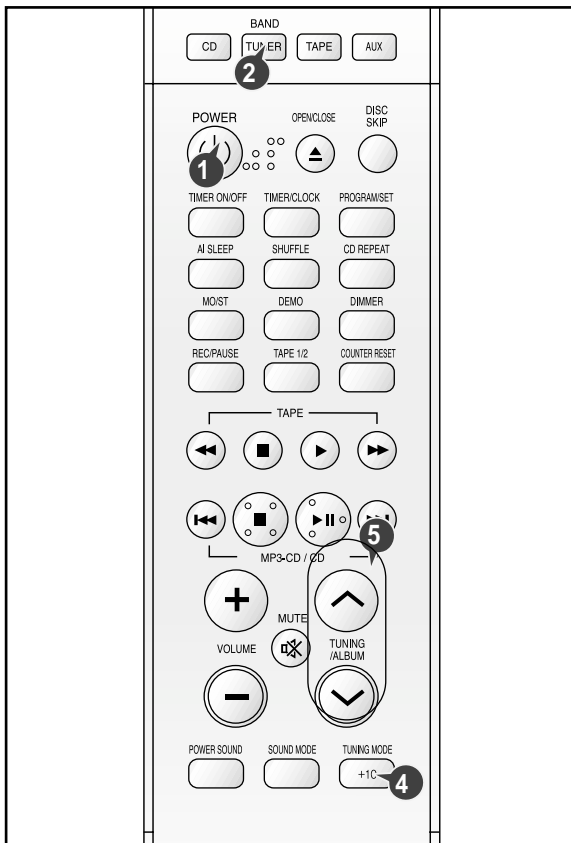
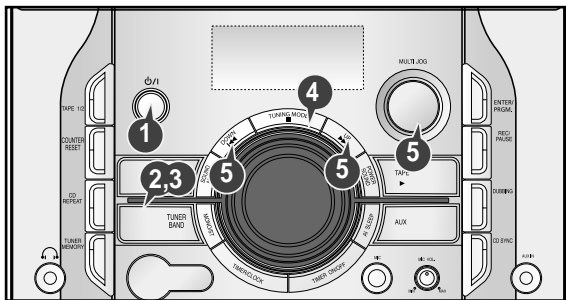

Improving Radio Reception

You can improve the quality of radio reception by:

- ◆ Rotating the FM or AM(MW) aerial
- ◆ Testing the positions of the FM and AM(MW) aerials before fixing them permanently

➤ If reception from a specific FM radio station is poor, press **MONO/ST.** to switch from stereo mode to mono. The quality of the sound will be improved.

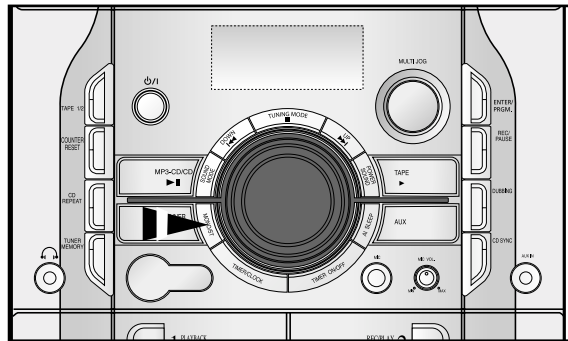

Listening to a Cassette

- Always treat your cassettes with care; refer, if necessary, to the section entitled "Precautions When Using Audio Cassettes" on page 25.

- 1 Switch the system on by pressing the **STANDBY/ON** button.
- 2 Select the **TAPE** function by pressing **TAPE** on the front panel.
- 3 Open either cassette **TAPE1** or **2** by pushing and releasing the Tape cover where **PUSH EJECT** (▲) is written.
- 4 Insert the pre-recorded cassette with the open edge of the tape facing downward.
- 5 Close the Tape by pushing on it until it clicks into place.
Result: Depending on the Tape selected, the **1** or **2** indication is displayed in front of the counter number.
- 6 If you have inserted two cassettes, press **TAPE1/2** on the front panel or directly the **TAPE1/2** button on the remote control to select the cassette to be played.
Result: Depending on the Tape selected, the **TAPE 1** or **TAPE 2** indication is displayed.

7 FOR MAX-X55/X56/X57

To listen to...	Press ...
Side A,B	TAPE (▶)

Result: The cassette starts playing.

FOR MAX-X65/X66

To listen to...	Press ...
Side A	TAPE (◀▶) once
Side B	TAPE (◀▶) twice

Result: The cassette starts playing.

When the cassette is stopped, select one of the following functions as required or on the remote control.

8 Main Unit

To...	Press...
Rewind the cassette	◀◀
Fast-forward the cassette	▶▶

Remote Control

To...	Press ...
Rewind the cassette	◀◀
Fast-forward the cassette	▶▶

- 9 To...
Stop the playback

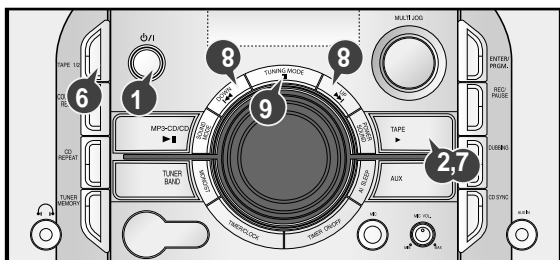

CD Synchro Record Feature

You can record a compact disc on a cassette in two different ways:

- ◆ Synchronize recording
- ◆ Direct recording

This feature enables you to synchronize the start of the recording with the start of the disc or track of your choice.

- 1 Switch the system on by pressing **STANDBY/ON**.
- 2 Insert a blank cassette in **TAPE2**.
- 3 Select the **CD** function by pressing **MP3-CD/CD** on the front panel.
- 4 Load a compact disc.
- 5 Select the required disc.
- 6 Select the required track and press **CD SYNC.** or press **CD SYNC.** directly to start recording at the beginning of the disc.
Result: **REC** and **SYNC** are displayed and recording starts.
- 7 To stop recording, press ■.

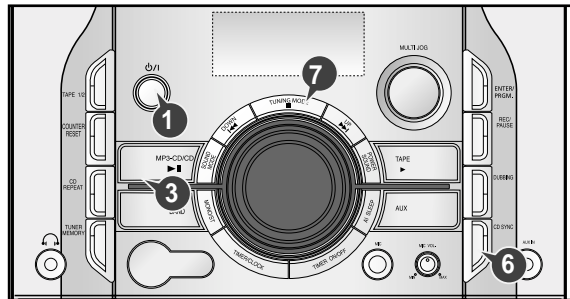

Recording a Compact Disc

The direct recording mode enables you to start recording with any track on the compact disc.

- ◆ You can only record on cassettes in Deck 2.
- ◆ You do not need to adjust the volume, as it has no effect on the recording.

- 1 Switch your system on by pressing **STANDBY/ON**.
- 2 Insert a blank cassette in **TAPE2**.
- 3 Select the **CD** function by pressing **MP3-CD/CD** on the front panel.
- 4 Load the compact disc.
- 5 Select the required disc.
- 6 Select the required track on the compact disc and press ▶|| on the front panel or ▶|| on the remote control to set the compact disc player to Pause mode.
- 7 Press the **REC/PAUSE**.
Result: **REC** is displayed.
- 8 Press the ▶|| to start playing the track.
Result: The track is recorded on the cassette.
- 9 To stop recording, press ■.

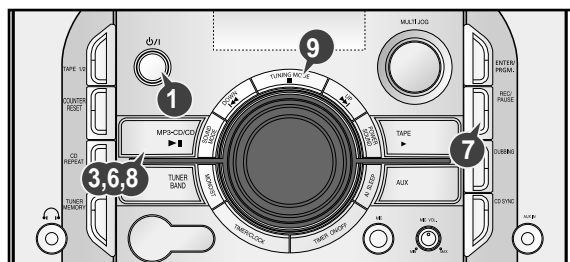

Recording a Radio Program

You can record a radio program of your choice.

- ◆ You can only record on cassettes in TAPE2.
- ◆ You do not need to adjust the volume, as it has no effect on the recording.

- 1 Switch the system on by pressing **STANDBY/ON**.
- 2 Insert a blank cassette in TAPE2.
- 3 Select the **TUNER** function by pressing **TUNER BAND**.
- 4 Select the radio station that you wish to record by pressing **Tuning** \wedge or \vee on the remote control or by press the \lll or \ggg on the front panel.
- 5 Press **REC/PAUSE**.
Result: REC is displayed in red and recording starts.
- 6 To stop recording, press \blacksquare .

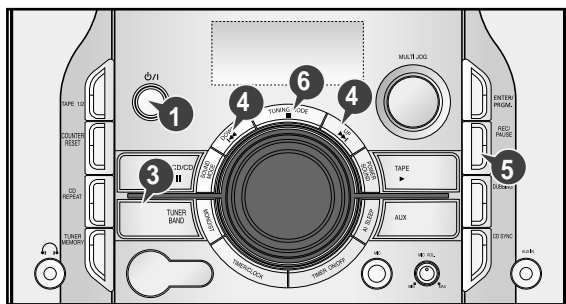

Copying a Cassette (Dubbing)

You can copy a cassette from TAPE1 to TAPE2.

- ◆ Normal speed dubbing in selecting Tape function mode.
- You do not need to adjust the volume, as it has no effect on the recording.
- ◆ Take care not to insert the tape to be copied in TAPE2, as it will be erased when you start recording.

- 1 Switch your system on by pressing **STANDBY/ON**.
- 2 Insert a blank cassette in TAPE2.
- 3 Insert the tape to be copied in TAPE1.
- 4 To copy a cassette at... Press...
Normal speed DUBBING

Result: The appropriate indications are displayed and the cassette in TAPE1 is copied to the cassette in TAPE2.

- 5 To stop dubbing, press \blacksquare .

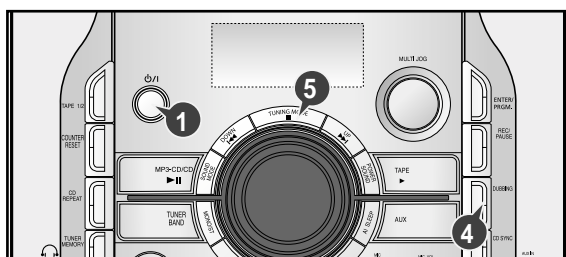

Tape Counter

When playing a cassette in one of the cassette decks, a counter is displayed to enable you to take note of the counter value at the start of each track to start playback at the beginning of the track to which you wish to listen.

- Before starting to record a cassette for which you wish to take note of the counter values at the beginning of each track, reset the counter by pressing **COUNTER RESET**.

- Each cassette Tape has a separate counter.

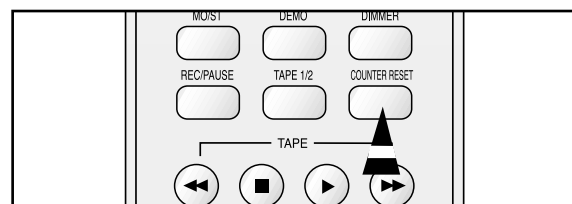
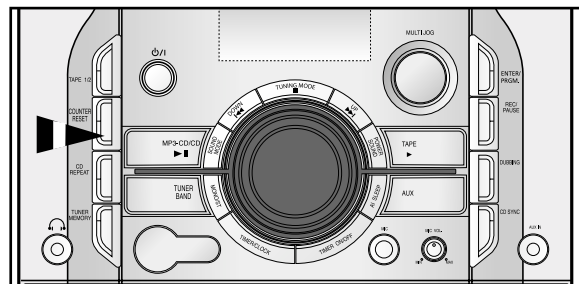

Selecting the Cassette Playback Mode (only for MAX-X65/X66)

Your micro component system has three cassette playback modes which enable you to listen to both sides of a cassette automatically.

Press **REVERSE MODE** until the appropriate symbol is displayed.

When the display indicates... The micro component system plays back...

- \lll One side of the selected cassette and then stops.
- \lll \ggg One side of the cassette. The other side of the cassette and then stops.
- \lll \ggg \lll \ggg Both sides of the cassette indefinitely until you press stop.

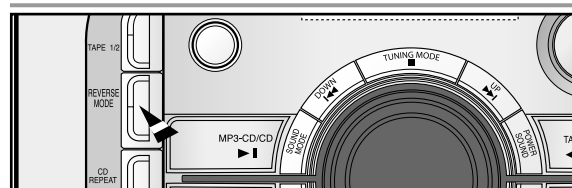

Timer Function

The timer enables you to switch the system on or off at specific times.

Example: You wish to wake up to music every morning.

- If you no longer want the system to be switched on or off automatically, you must cancel the timer.
- ◆ Before setting the timer, check that the current time is correct.
- ◆ For each step, you have a few seconds to set the required options. If you exceed this time, you must start again.

- 1** Switch the system on by pressing **STANDBY/ON**.
- 2** Press **TIMER/CLOCK** until **TIMER** is displayed.
- 3** Press **ENTER/PRGM.**
Result: **ON TIME** is displayed (instead of the equalizer symbols) for a few seconds, followed by any switch-on time already set; you can set the timer switch-on time.
- 4** Set the timer switch-on time.
 - a** Set the hour by tuning the **MULTI JOG** knob to the right or to the left.
 - b** Press **ENTER/PRGM.**
Result: The minutes flash.
 - c** Set the minutes by tuning the **MULTI JOG** knob to the right or to the left.
 - d** Press **ENTER/PRGM.**
Result: **OFF TIME** is displayed (instead of the equalizer symbols) for a few seconds, followed by any switch-off time already set; you can now set the timer switch-off time.
- 5** Set the timer switch-off time.
 - a** Set the hour by tuning the **MULTI JOG** knob to the right or to the left.
 - b** Press **ENTER/PRGM.**
Result: The minutes flash.
 - c** Set the minutes by tuning the **MULTI JOG** knob to the right or to the left.
 - d** Press **ENTER/PRGM.**
Result: **VOL XX** is displayed, where **XX** corresponds to the volume already set.
- 6** Press **TUNING Down** and **Up** to adjust the volume level and press **ENTER/PRGM.**
Result: The source to be selected is displayed.
- 7** Turn the **MULTI JOG** knob to select the source to be played when the system switches on.

If you select...	You must also...
TAPE (cassette)	Insert a recorded cassette in one of the decks before setting the system to standby.
TUNER (radio)	<ol style="list-style-type: none"> a Press ENTER/PRGM. b Select a preset station by tuning the Multi Jog knob to the right or to the left.
CD (compact disc)	Load one or more compact discs.
- 8** Press **ENTER/PRGM.** to confirm the timer.
- 9** Press **STANDBY/ON** to set the system to standby mode.
Result: **T** is displayed to the top of the time, indicating that the timer has been set. The system will switch on and off automatically at the required times.

➤ If the timer switch on and off times are identical, the word **ERROR** is displayed.

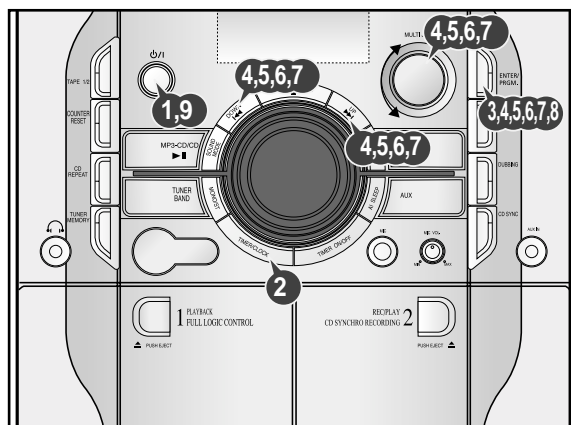

To set the timer function

- ◆ You may use **◀▶** buttons on the front panel to adjust in step 4, 5, 6, 7.

Cancelling the Timer

After having set the timer, it will start automatically as shown by the **TIMER** indication on the display. If you no longer wish to use the timer, you must cancel it.

➤ You can stop the timer at any time (system on or in standby mode).

To...	Press Timer-On/Off...
Cancel the timer	Once. Result: T is no longer displayed.
Restart the timer	Twice. Result: T is displayed again.

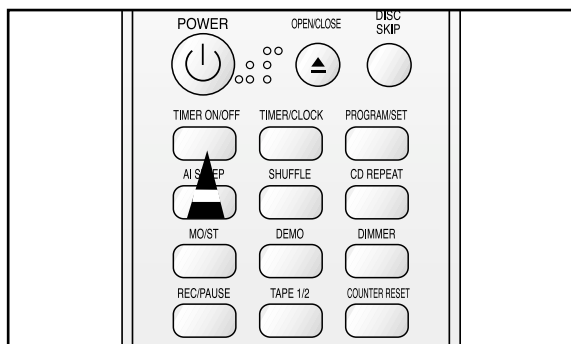

Mute Function

GB

You can turn the sound off temporarily on your system.
Example: You wish to answer a telephone call.

- 1 Press **MUTE**.
- 2 To switch the sound back on, press **MUTE** again or the **VOLUME** buttons.

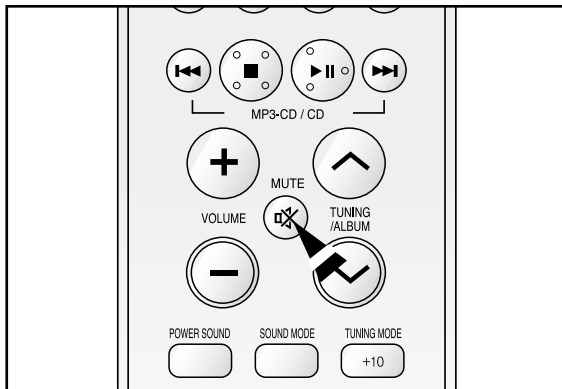

Selecting Sound Mode

Your mini-compact system is equipped with a preset equalizer that allows you to choose the most appropriate balance between treble and bass frequencies, according to the type of music you are listening to.

- 1 Turn **SOUND MODE** on the front panel or Press **SOUND MODE** on the remote control until the required option is selected.

To obtain a...	Select...
Normal balance (linear)	PASS
Balance suitable for pop music	POP
Balance suitable for rock music	ROCK
Balance suitable for classic music	CLASSIC
Balance suitable for hall	HALL
Balance suitable for live	LIVE
Balance suitable for cinema	CINEMA

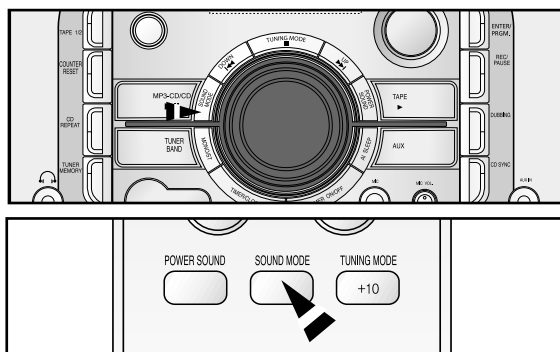

Power Sound Function

Your mini-compact system is equipped with the function of **POWER SOUND mode**.
The function of POWER SOUND mode amplifies bass and improves high key or bass twice as much as you to appreciate powerful real sound.

- 1 Press the **POWER SOUND** button on the front panel.
Result: "P.SOUND" is displayed.
- 2 To cancel this function, press **POWER SOUND** button again.

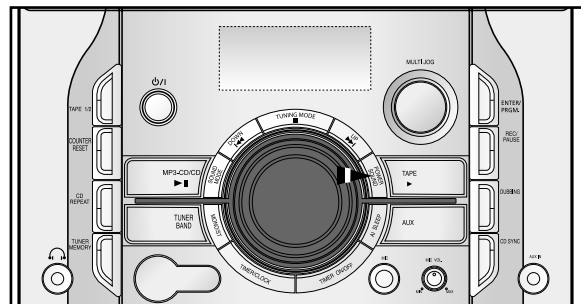

Setting the System to Switch off Automatically

While listening to a compact disc or a cassette, you can set the system to switch off automatically

Example: You wish to go to sleep to music.

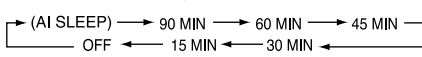
- 1 Press **AI SLEEP**.
Result: playback starts and the following indications are displayed:
90 MIN
- 2 Press **AI SLEEP** once or more times to indicate how long the system should continue playing before it switches off:

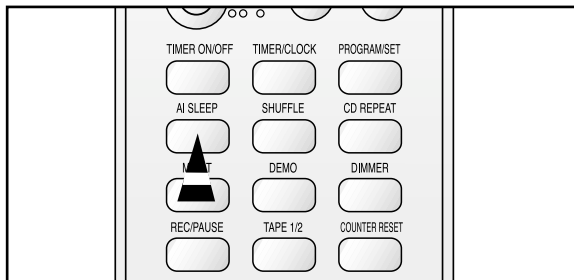
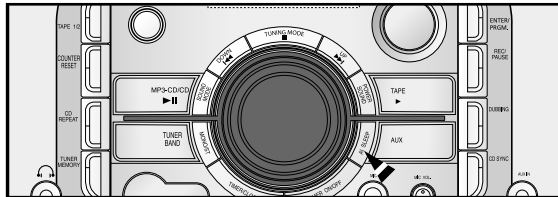
- At any time, you can:
 - ◆ Check the remaining time by pressing **AI SLEEP**
 - ◆ Change the remaining time by repeating Steps 1 and 2
- 3 Press **AI SLEEP** once or more times until **AI SLEEP** is displayed.
Result: The system will automatically switch off at the end of the disc or cassette.
- 4 To cancel SLEEP function, press **AI SLEEP** once or more times until **OFF** is display.



Connecting Headphones

You can connect a set of headphones to your mini-compact system so that you can listen to music or radio programmers without disturbing other people in the room. The headphones must have a 3.5ø jack or an appropriate adapter.



Connect the headphones to the **PHONES** jack on the front panel.

Result: The loudspeakers are no longer used to output the sound.

- ☞ Prolonged use of headphones at a high volume may damage your hearing.

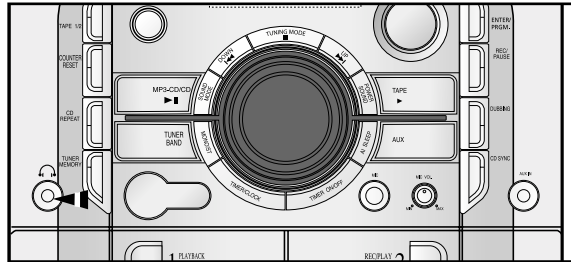

Microphone Function(option)

The microphone enables the user to mix in his or her vocals to sing-along with the music or recording .

Preparation

Plug the microphone with a 6.3mm mic jack into microphone terminal.

- 1 Turn the **MIC VOL.** knob to adjust the mic volume.

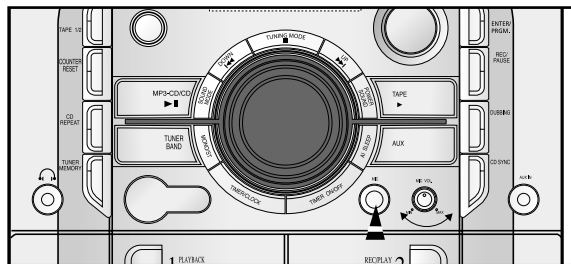

Safety Precautions

GB

The following diagrams illustrate the precautions to be taken when using or moving your mini-compact system.

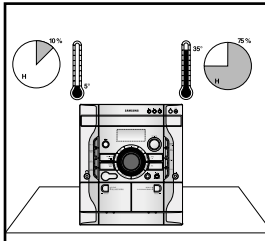

Ambient operating conditions:
Ambient temperature 5°C-35°C
Humidity 10-75%

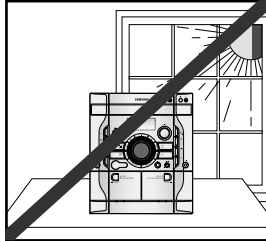

Do not expose the unit to direct sun radiation or other heat sources. This could lead to overheating and malfunction of the unit.

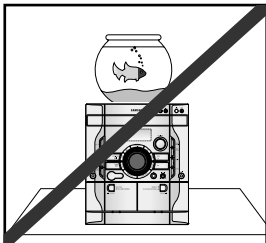

Do not place potted plants or vases on top of the unit. Moisture entering the unit could lead to dangerous electric shock and can cause equipment damage. In such events immediately disconnect the main plug from the socket.

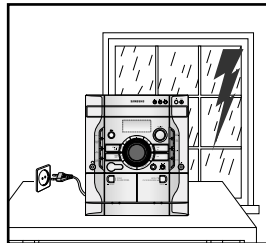

During thunderstorms, disconnect the main plug from the socket. Main voltage peaks due to lightning could damage the unit.

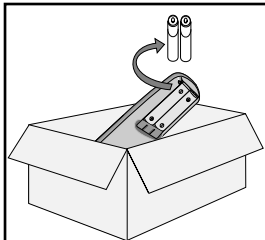

Remove the batteries from the remote control, if not used for any extended period. Leaking batteries can cause serious damage to the remote control.

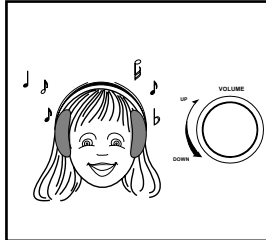

When using headphones, take care not to listen at excessive volumes. Extended use of headphones at high volumes will lead to hearing damage.

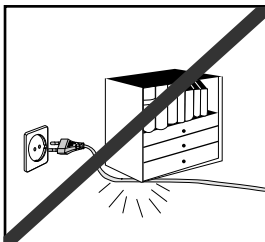

Do not place heavy items on the main lead. Main cable damage can lead to damage of the equipment (fire hazard) and can cause electric shock.

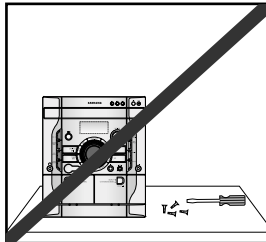

Do not remove any equipment panels. The inside of the unit contains live components, which cause electric shock.

Cleaning Your Mini-Compact System

To obtain the best possible results from your mini-compact system, you must clean the following elements regularly:

- ◆ The outer casing
- ◆ The compact disc player
- ◆ The cassette players (heads, rollers and drive capstans)
 - ◆ Always unplug the system from the wall outlet:
 - ◆ Before cleaning it
 - ◆ If you are not going to be using it for a long time

Outer Casing

Clean the outer casing regularly using a soft cloth and a light detergent. Do not use abrasive powders, liquids or aerosol cleaners. Never let any liquids get into the system.

Compact Disc Player

- 1 Before playing a compact disc, clean it with a special CD cleaning agent. Do not use the same cleaning agents as for vinyl LP records. Carefully wipe the disc from the centre outward.
- 2 Regularly clean the player with a special cleaning disc (available from your local dealer).

Tape Decks

- 1 Press **PUSH EJECT** (▲) to open the cassette deck.
- 2 Use a cotton bud and a special cassette cleaning agent to clean the:
 - ◆ Head (1)
 - ◆ Rollers (2)
 - ◆ Drive capstans (3)

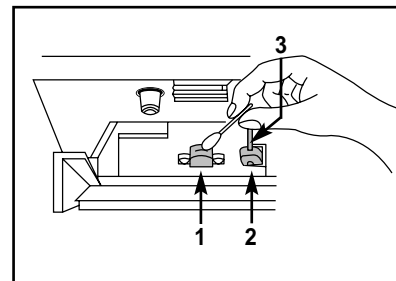

- ◆ If you will not be using the remote control for a long time, remove the batteries to prevent corrosion.
- ◆ Although your system is very hard-wearing, it should not be used in an excessively dusty environment or subjected to shocks or extreme heat (close to heating appliances or in direct sunlight, etc.).
- ◆ If the unit emits an unpleasant odor when in use, unplug it from the main supply and contact the after-sales service.

Precautions When Using Compact Discs

- ◆ Handle your compact discs with care. Always hold them by the edges to avoid leaving fingerprints on the shiny surface.
- ◆ When you have finished playing a compact disc, always put it back in its case.
- ◆ Do not fix paper or adhesive tape to the discs and do not write on the label.
- ◆ Clean them with a special-purpose cloth.
- ◆ Store your compact discs in a clean place, out of direct sunlight, where they will not be exposed to high temperatures.
- ◆ Always use compact discs marked  .

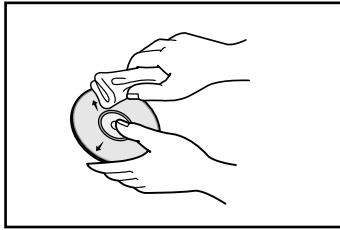

Precautions When Using Audio Cassettes

- ◆ Check that the tape in the cassette is sufficiently taut.
- ◆ To prevent erasing a cassette that you wish to keep, remove the safety tab on the upper edge of the cassette. To record a cassette, where the tab has been broken, simply cover the opening with adhesive tape.
- ◆ When you have finished playing a cassette, always put it back in its case.
- ◆ Store your cassettes in a clean place, out of direct sunlight, where they will not be exposed to high temperatures.
- ◆ Avoid using 120-minute cassettes as they place unnecessary strain on the tape mechanism.

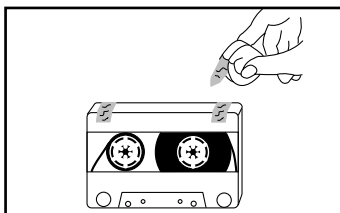
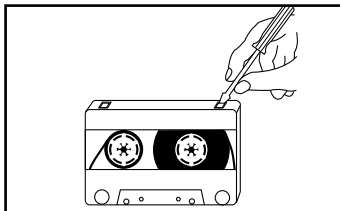
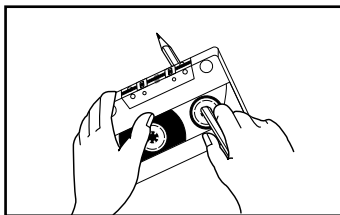

Before Contacting the After-Sales Service



It always takes a little time to become familiar with a new appliance. If you have any of the problems listed below, try the solutions given. They may save you the time and inconvenience of an unnecessary service call.

Problem	Checks/Explanation
The system does not work	<ul style="list-style-type: none"> • The main lead is not correctly plugged into a wall socket or the wall socket is not switched on. • The remote control batteries need replacing or the polarity has not been respected. • The STANDBY/ON button has not been pressed.
There is no sound	<ul style="list-style-type: none"> • The volume has been completely turned down. • The correct function (TUNER, CD, TAPE, AUX) has not been selected. • You have connected a set of earphones. • The loudspeaker wires have been disconnected. • The MUTE button has been pressed.
The Timer does not work	<ul style="list-style-type: none"> • The timer has been stopped by pressing TIMER ON/OFF.
In case it does not work, even the action is taken as above.	<ul style="list-style-type: none"> • Press the STOP BUTTON for 5 seconds in power 'OFF'(standby), then it is returned the original position (RESET)
The compact disc player does not start playing	<ul style="list-style-type: none"> • The CD function has not been selected. • The disc has been inserted face down or is either dirty or scratched. • The laser sensor is dirty or dusty. • The system has not been installed on a flat, horizontal surface. • Condensation has formed in the player; leave the system in a warm, airy room for at least one hour.
The tape does not start playing	<ul style="list-style-type: none"> • The TAPE function has not been selected. • The cassette has not been inserted correctly. • The cassette player has not been closed. • The tape is either slack or broken.
The volume falls off The cassette is not erased correctly There is excessive wow and flutter	<ul style="list-style-type: none"> • The audio heads are dirty. • The rollers or drive capstans are dirty. • The tape is worn.
Reception is poor or no radio stations are received at all	<ul style="list-style-type: none"> • The TUNER function has not been selected. • The radio frequency has not been correctly selected. • The aerial has been disconnected or is not facing the right way. Turn it until you find the best orientation. • You are in a building that blocks radio waves; you must use an outside aerial.

If the above guidelines do not allow you to solve the problem, take a note of:

- ◆ The model and serial numbers, normally printed on the rear of the system
 - ◆ Your warranty details
 - ◆ A clear description of the problem
- Then contact your local dealer or SAMSUNG after-sales service.

Technical Specifications

GB

SAMSUNG strives to improve its products at all times. Both the design specifications and these user instructions are thus subject to change without notice.

RADIO

AM (MW)

Signal/noise ratio	40 dB
Usable sensitivity	54 dB
Total harmonic distortion	2 %

FM

Signal/noise ratio	62 dB
Usable sensitivity	10 dB
Total harmonic distortion	0.3 %

COMPACT DISC PLAYER

Capacity	3 discs
Frequency range	20 Hz - 20 KHz (± 1 dB)
Signal/noise ratio	90 dB (at 1 KHz) with filter
Distortion	0.05 % (at 1 KHz)
Channel separation	74 dB
Disc sizes	Diameter: 120 or 80 mm. Thickness: 1.2 mm

TAPE DECK

Frequency range	125 Hz ~ 8 KHz
Signal/noise ratio	40 dB
Channel separation	35 dB
Erasing effect	50 dB

AMPLIFIER

Output power	
Front Speaker (6 Ω)(MAX-X55)	40 Watts/CH RMS,IEC (total harmonic distortion: 10 %)
Front Speaker (6 Ω)(MAX-X56)	80 Watts/CH RMS,IEC (total harmonic distortion: 10 %)
Front Speaker (6 Ω)(MAX-X57)	90 Watts/CH RMS,IEC (total harmonic distortion: 10 %)
Front Speaker (6 Ω)(MAX-X65)	150 Watts/CH RMS,IEC (total harmonic distortion: 10 %)
Front Speaker (6 Ω)(MAX-X66)	150 Watts/CH RMS,IEC (total harmonic distortion: 10 %)
Subwoofer Speaker (4 Ω)(MAX-X66)	150 Watts/CH RMS,IEC (total harmonic distortion: 10 %)
Channel separation	45 dB
Signal/noise ratio	75 dB

GENERAL

Power Consumption	85W(MAX-X55)
Power Consumption	65W(MAX-X56/X57)
Power Consumption	40W(MAX-X65/X66)
Dimensions	270 (W) x 317 (H) x 395 (D) mm

Contact SAMSUNG WORLD WIDE

If you have any questions or comments relating to Samsung products, please contact the SAMSUNG customer care centre.



Region	Country	Customer Care Center	Web Site
North America	CANADA	1-800-SAMSUNG (7267864)	www.samsung.com/ca
	MEXICO	01-800-SAMSUNG (7267864)	www.samsung.com/mx
	U.S.A	1-800-SAMSUNG (7267864)	www.samsung.com
Latin America	ARGENTINE	0800-333-3733	www.samsung.com/ar
	BRAZIL	0800-124-421 4004-0000	www.samsung.com/br
	CHILE	800-726-7864 (SAMSUNG)	www.samsung.com/cl
	COSTA RICA	0-800-507-7267	www.samsung.com/latin
	ECUADOR	1-800-10-7267	www.samsung.com/latin
	EL SALVADOR	800-6225	www.samsung.com/latin
	GUATEMALA	1-800-299-0013	www.samsung.com/latin
	JAMAICA	1-800-234-7267	www.samsung.com/latin
	PANAMA	800-7267	www.samsung.com/latin
	PUERTO RICO	1-800-682-3180	www.samsung.com/latin
	REP. DOMINICA	1-800-751-2676	www.samsung.com/latin
	TRINIDAD & TOBAGO	1-800-7267-864	www.samsung.com/latin
	VENEZUELA	0-800-100-5303	www.samsung.com/latin
COLOMBIA	01-8000112112	www.samsung.com.co	
Europe	BELGIUM	02 201 2418	www.samsung.com/be
	CZECH REPUBLIC	844 000 844 Distributor pro Českou republiku : Samsung Zrt., česká organizační složka Vyskočilova 4, 14000 Praha 4	www.samsung.com/cz
	DENMARK	70 70 19 70	www.samsung.com/dk
	FINLAND	030-6227 515	www.samsung.com/fi
	FRANCE	3260 SAMSUNG or 08 25 08 65 65 (€ 0,15/Min)	www.samsung.com/fr
	GERMANY	01805 - 121213 (€ 0,14/Min)	www.samsung.de
	HUNGARY	06-80-SAMSUNG (7267864)	www.samsung.com/hu
	ITALIA	800-SAMSUNG (7267864)	www.samsung.com/it
	LUXEMBURG	0032 (0)2 201 24 18	www.samsung.lu
	NETHERLANDS	0900 20 200 88 (€ 0,10/Min)	www.samsung.com/nl
	NORWAY	815-56 480	www.samsung.com/no
	POLAND	0 801 801 881	www.samsung.com/pl
	PORTUGAL	80 8 200 128	www.samsung.com/pt
	SLOVAKIA	0800-SAMSUNG (726786)	www.samsung.com/sk
	SPAIN	902 10 11 30	www.samsung.com/es
	SWEDEN	0771-400 200	www.samsung.com/se
	U.K	0870 SAMSUNG (7267864)	www.samsung.com/uk
	Republic of Ireland	0818 717 100	www.samsung.com/uk
	Switzerland	0800-7267864	www.samsung.com/ch
CIS	RUSSIA	8-800-200-0400	www.samsung.ru
	KAZAHSTAN	8-800-080-1188	www.samsung.kz
	UZBEKISTAN	8-800-120-0400	www.samsung.uz
	UKRAINE	8-800-502-0000	www.samsung.com/ur
	LITHUANIA	8-800-77777	www.samsung.lt
	LATVIA	800-7267	www.samsung.com/lv/index.htm
	ESTONIA	800-7267	www.samsung.ee
Asia Pacific	AUSTRALIA	1300 362 603	www.samsung.com/au
	CHINA	800-810-5858, 010-6475 1880	www.samsung.com.cn
	HONG KONG	3698 - 4698	www.samsung.com/hk
	INDIA	3030 8282 1800 110011	www.samsung.com/in
	INDONESIA	0800-112-8888	www.samsung.com/id
	JAPAN	0120-327-527	www.samsung.com/jp
	MALAYSIA	1800-88-9999	www.samsung.com/my
	PHILIPPINES	1800-10-SAMSUNG (7267864)	www.samsung.com/ph
	SINGAPORE	1800-SAMSUNG (7267864)	www.samsung.com/sg
	THAILAND	1800-29-3232 02-689-3232	www.samsung.com/th
	TAIWAN	0800-329-999	www.samsung.com/tw
VIETNAM	1 800 588 889	www.samsung.com/vn	
Middle East & Africa	SOUTH AFRICA	0860 7267864 (SAMSUNG)	www.samsung.com/za
	U.A.E	800SAMSUNG (7267864) 8000-4726	www.samsung.com/mea

THIS APPLIANCE IS MANUFACTURED BY:



ELECTRONICS

AH68-01932B