

**SAMSUNG**

# MICROWAVE OVEN

## Owner's Instructions

**M187DN**

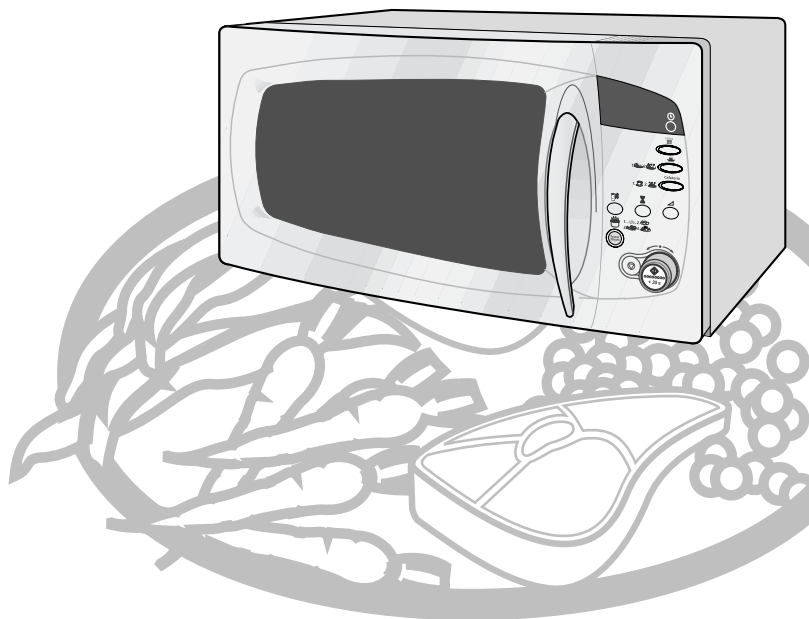

Oven .....	2
Accessories .....	2
Control Panel .....	2
Using this Instruction Booklet .....	3
Safety Precautions.....	3
Installing Your Microwave Oven .....	5
Setting the Time.....	5
What to Do if You are in Doubt or Have a Problem.....	6
Cooking / Reheating .....	6
Power Levels .....	7
Stopping the Cooking .....	7
Adjusting the Cooking Time.....	7
Using the Auto Reheat Feature .....	8
Auto Reheat Settings.....	8
Using the Cafeteria Feature .....	9
Cafeteria Settings .....	9
Using the Auto Power Defrost Feature.....	10
Auto Power Defrost Settings .....	10
Using the Power Steam Function .....	11
Setting a Standing Time .....	12
Using the Deodorization Feature.....	12
Switching the Beeper Off.....	12
Safety-Locking Your Microwave Oven .....	12
Cookware Guide .....	13
Cleaning Your Microwave Oven.....	14
Storing and Repairing Your Microwave Oven .....	14
Technical Specifications .....	15

## Oven

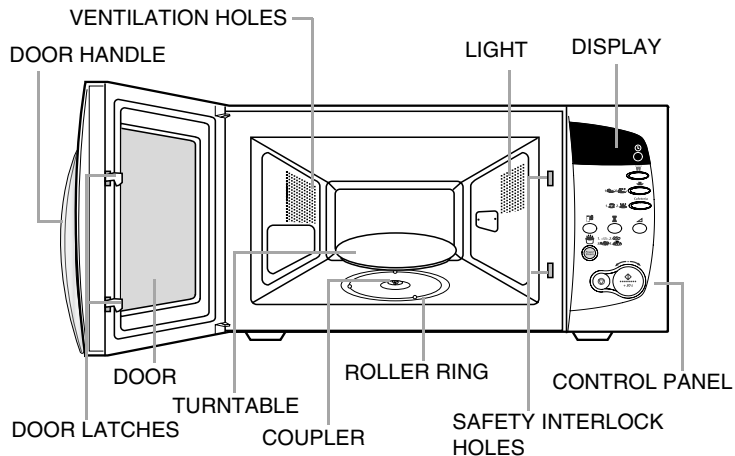

## Accessories

Depending on the model that you have purchased, you are supplied with several accessories that can be used in a variety of ways.

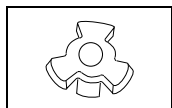

- Coupler**, already placed over the motor shaft in the base of the oven.  
Purpose : The coupler rotates the turntable.

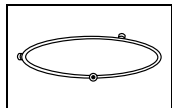

- Roller ring**, to be placed in the centre of the oven.  
Purpose : The roller ring supports the turntable.

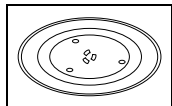

- Turntable**, to be placed on the roller ring with the centre fitting to the coupler.  
Purpose : The turntable serves as the main cooking surface; it can be easily removed for cleaning.

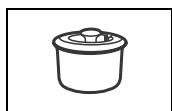

- Power steam cooker**, see page 11.  
Purpose : Use the plastic steam cooker when using power steam function.



**DO NOT** operate the microwave oven without the roller ring and turntable.

## Control Panel

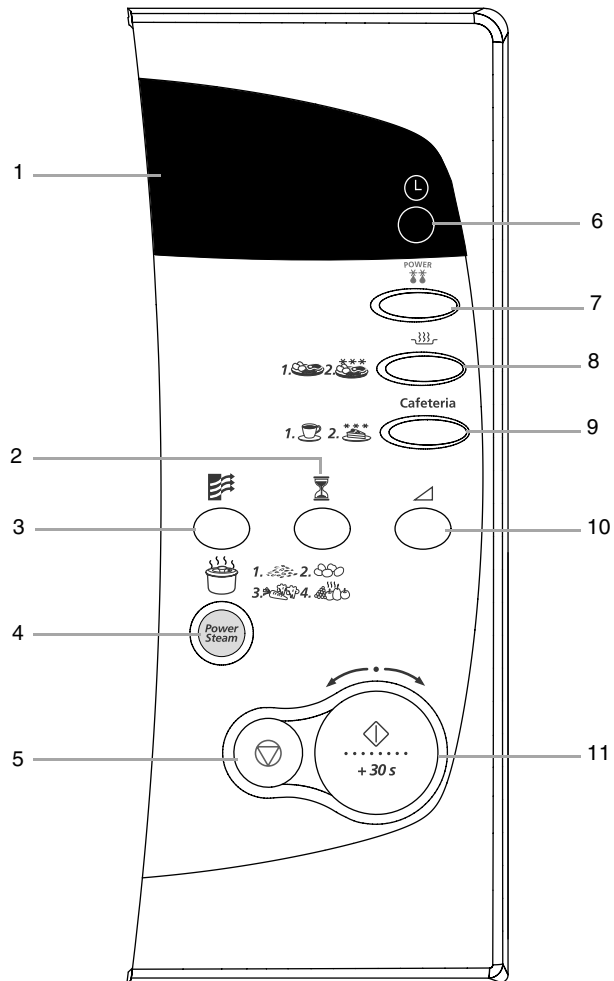

- |                          |  |
|--------------------------|--|
| 1. DISPLAY               | 7. AUTO POWER DEFROST BUTTON                                     |
| 2. STANDING TIME SETTING | 8. AUTO REHEAT SELECTION   |
| 3. DEODORIZATION BUTTON  | 9. CAFETERIA SELECTION   |
| 4. POWER STEAM SELECTION | 10. POWER LEVEL SETTING  |
| 5. STOP/CANCEL BUTTON    | 11. START BUTTON/ DIAL KNOB (cook time, weight and serving size) |
| 6. CLOCK SETTING         |  |

## Using this Instruction Booklet

You have just purchased a SAMSUNG microwave oven. Your Owner's Instructions contain much valuable information on cooking with your microwave oven:

- Safety precautions
- Suitable accessories and cookware
- Useful cooking tips

At the front of the booklet you will find illustrations of the oven, and more importantly the control panel, so that you can find the buttons more easily.

The step-by-step procedures use three different symbols.



Important



Note

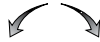

Turn

### PRECAUTIONS TO AVOID POSSIBLE EXPOSURE TO EXCESSIVE MICROWAVE ENERGY

Failure to observe the following safety precautions may result in harmful exposure to microwave energy.

- Under no circumstances should any attempt be made to operate the oven with the door open or to tamper with the safety interlocks (door latches) or to insert anything into the safety interlock holes.
- Do not place any object between the oven door and front face or allow food or cleaner residues to accumulate on sealing surfaces. Ensure that the door and door sealing surfaces are kept clean by wiping after use first with a damp cloth and then with a soft dry cloth.
- Do not operate the oven if it is damaged until it has been repaired by a qualified microwave service technician trained by the manufacturer. It is particularly important that the oven door closes properly and that there is no damage to the:
  - Door, door seals and sealing surfaces
  - Door hinges (broken or loose)
  - Power cable
- The oven should not be adjusted or repaired by anyone other than a properly qualified microwave service technician trained by the manufacturer.

## Safety Precautions

### Important Safety Instructions.

Read Carefully and keep for future reference.

Before cooking food or liquids in your microwave oven, please check that the following safety precautions are taken.

- DO NOT** use any metallic cookware in the microwave oven:
  - Metallic containers
  - Dinnerware with gold or silver trimmings
  - Skewers, forks, etc.

Reason: Electric arcing or sparking may occur and may damage the oven.
- DO NOT** heat:
  - Airtight or vacuum-sealed bottles, jars, containers

Ex) Baby food jars

  - Airtight food.

Ex) Eggs, nuts in shells, tomatoes

Reason: The increase in pressure may cause them to explode.

Tip: Remove lids and pierce skins, bags, etc.
- DO NOT** operate the microwave oven when it is empty.

Reason: The oven walls may be damaged.

Tip: Leave a glass of water inside the oven at all times. The water will absorb the microwaves if you accidentally set the oven going when it is empty.
- DO NOT** cover the rear ventilation slots with cloths or paper.

Reason: The cloths or paper may catch fire as hot air is evacuated from the oven.
- ALWAYS** use oven gloves when removing a dish from the oven.

Reason: Some dishes absorb microwaves and heat is always transferred from the food to the dish. The dishes are therefore hot.
- DO NOT** touch heating elements or interior oven walls.

Reason: These walls may be hot enough to burn even after cooking has finished, even though they do not appear to be so. Do not allow inflammable materials to come into contact with any interior area of the oven. Let the oven cool down first.
- To reduce the risk of fire in the oven cavity:
  - Do not store flammable materials in the oven
  - Remove wire twist ties from paper or plastic bags
  - Do not use your microwave oven to dry newspapers
  - If smoke is observed, keep the oven door closed and switch off or disconnect the oven from the power supply
- Take particular care when heating liquids and baby foods.
  - **ALWAYS** allow a standing time of at least 20 seconds after the oven has been switched off so that the temperature can equalize.
  - Stir during heating, if necessary, and **ALWAYS** stir after heating.
  - Take care when handling the container after heating. You may burn yourself, if the container is too hot.

## Safety Precautions (continued)

GB

- A risk of delayed eruptive boiling exists.
  - To prevent delayed boiling and possible scalding, you should put a plastic spoon or glass stick into the beverages and stir before, during and after heating.  
Reason: During the heating of liquids the boiling point can be delayed; this means that eruptive boiling can start after the container is removed from the oven. You may scald yourself.
  - In the event of scalding, follow these FIRST AID instructions:
    - \* Immerse the scalded area in cold water for at least 10 minutes.
    - \* Cover with a clean, dry dressing.
    - \* Do not apply any creams, oils or lotions.
  - **NEVER** fill the container to the top and choose a container that is wider at the top than at the bottom to prevent the liquid from boiling over. Bottles with narrow necks may also explode if overheated.
  - **ALWAYS** check the temperature of baby food or milk before giving it to the baby.
  - **NEVER** heat a baby's bottle with the teat on, as the bottle may explode if overheated.
9. Be careful not to damage the power cable.
- Do not immerse the power cable or plug in water and keep the power cable away from heated surfaces.
  - Do not operate this appliance if it has a damaged power cable or plug.
10. Stand at arm's length from the oven when opening the door.  
Reason: The hot air or steam released may cause scalding.
11. Keep the inside of the oven clean.  
Reason: Food particles or spattered oils stuck to oven walls or floor can cause paint damage and reduce the efficiency of the oven.
12. You may notice a "Clicking" sound during operation (especially when the oven is defrosting).  
Reason: This sound is normal when the electrical power output is changing.
13. When the microwave oven is operating without any load, the power will be cut off automatically for safety. You can operate normally after letting it stand for over 30 minutes.

### **IMPORTANT SAFETY INSTRUCTIONS**

During cooking, you should look into the oven from time to time when food is being heated or cooked in disposable containers of plastic, paper or other combustible materials.

### **IMPORTANT**

Young children should **NEVER** be allowed to use or play with the microwave oven. Nor should they be left unattended near the microwave oven when it is in use. Items of interest to children should not be stored or hidden just above the oven.

### • **WARNING:**

If the door or door seals are damaged, the oven must not be operated until it has been repaired by a competent person.

### **WARNING:**

It is hazardous for anyone other than a competent person to carry out any service or repair operation which involves the removal of a cover which gives protection against exposure to microwave energy.

### **WARNING:**

- Liquids and other foods must not be heated in sealed containers since they are liable to explode.

### **WARNING:**

Only allow children to use the oven without supervision when adequate instructions have been given so that the child is able to use the oven in a safe way and understands the hazards of improper use.

## Installing Your Microwave Oven

Place the oven on a flat, level surface that is strong enough to safely bear the weight of the oven.

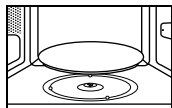
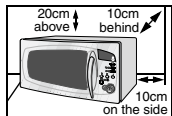

1. When you install your oven, Make sure there is adequate ventilation for your oven by leaving at least 10 cm (4 inches) of space behind, and on the sides of the oven, at least 20 cm (8 inches) of space above the oven.
2. Remove all packing materials inside the oven. Install the roller ring and turntable. Check that the turntable rotates freely.
3. This microwave oven has to be positioned so that plug is accessible.

⚠ **Never** block the air vents as the oven may overheat and automatically switch itself off. It will remain inoperable until it has cooled sufficiently.

⚠ For your personal safety, plug the cable into a 3-pin, 230 Volt, 50Hz, AC earthed socket. If the power cable of this appliance is damaged, it must be replaced by a special cable (I-SHENG SP022, KDK KKP4819D, EUROELECTRIC 3410, SAMIL SP-106B, MOONSUNG EP-48E, HIGH PROJECT H.P 3). Contact your local dealer to have it replaced. The power cable of ISRAEL is PENCON(ZD16A), S/AFRICA APEX LEADS SA16 and NIGERIA, GHANA, KENYA and U.A.E is PENCON(UD13A1).

⚠ **Do not** install the microwave oven in hot or damp surroundings like next to a traditional oven or radiator. The power supply specifications of the oven must be respected and any extension cable used must be of the same standard as the power cable supplied with the oven. Wipe the interior and the door seal with a damp cloth before using your microwave oven for the first time.

## Setting the Time

Your microwave oven has an inbuilt clock. The time can be displayed in either the 24-hour or 12-hour notation. You must set the clock:

- When you first install your microwave oven
- After a power failure

☒ Do not forget to reset the clock when you switch to and from summer or winter time.

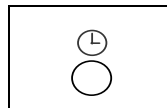

1. To display the time in the... Then press the button...

24-hour notation      Once  
12-hour notation      Twice

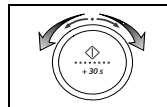

2. Turn the **dial knob** to set the hour.

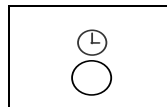

3. Press the button.

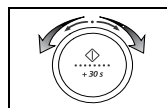

4. Turn the **dial knob** to set the minute.

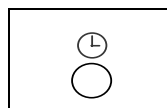



5. Press the button.

## What to Do if You are in Doubt or Have a Problem

GB

If you have any of the problems listed below try the solutions given.

- ◆ This is normal.
  - Condensation inside the oven.
  - Air flow around the door and outer casing.
  - Light reflection around the door and outer casing.
  - Steam escaping from around the door or vents.
  
- ◆ The oven does not start when you press the  button.
  - Is the door completely closed?
  
- ◆ The food is not cooked at all
  - Have you set the timer correctly and/or pressed the  button?
  - Is the door closed?
  - Have you overloaded the electric circuit and caused a fuse to blow or a breaker to be triggered?
  
- ◆ The food is either overcooked or undercooked
  - Was the appropriate cooking length set for the type of food?
  - Was an appropriate power level chosen?
  
- ◆ Sparking and cracking occur inside the oven (arcing)
  - Have you used a dish with metal trimmings?
  - Have you left a fork or other metal utensil inside the oven?
  - Is aluminium foil too close to the inside walls?
  
- ◆ The oven causes interference with radios or televisions
  - Slight interference may be observed on televisions or radios when the oven is operating. This is normal. To solve this problem, install the oven away from televisions, radios and aerials.
  - If interference is detected by the oven's microprocessor, the display may be reset. To solve this problem, disconnect the power plug and reconnect it. Reset the time.
  
- ✉ If the above guidelines do not enable you to solve the problem, contact your local dealer or SAMSUNG after-sales service.

## Cooking / Reheating

The following procedure explains how to cook or reheat food.

**ALWAYS** check your cooking settings before leaving the oven unattended.

**First, place the food in the centre of the turntable. Then, close the door.**

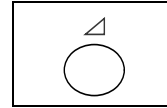

1. Press the  button.

**Result:**

The 850W (maximum cooking power) indications are displayed:  
Select the appropriate power level by pressing the  button again until the corresponding wattage is displayed. Refer to the power level table.

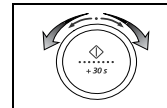

2. Set the cooking time by turning the **dial knob** as required.

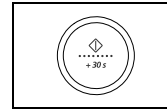

3. Press the  button.

**Result:**

The oven light comes on and the turntable starts rotating.  
Cooking starts and when it has finished the oven beeps four times.



**Never** switch the microwave oven on when it is empty.



If you wish to heat a dish for a short period of time at maximum power(850W), simply press the **+30s** button once for each 30 seconds of cooking time. The oven starts immediately.

## Power Levels

You can choose from among the power levels below.

Power Level	Output
HIGH	850 W
MEDIUM HIGH	600 W
MEDIUM	450 W
MEDIUM LOW	300 W
DEFROST	180 W
LOW / KEEP WARM	100 W

☒ If you select the higher power level, the cooking time must be decreased.

☒ If you select the lower power level, the cooking time must be increased.

If you want to add the cooking time by turning dial knob.

Time	Increasing Time
Up to 1 min	5 sec. unit
1 - 3 min	10 sec. unit
3 - 10 min	30 sec. unit
10 - 20 min	1 min unit
20 - 40 min	2 min unit
40 - 99 min	5 min unit

## Stopping the Cooking

You can stop cooking at any time to check the food.

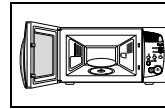

1. To stop temporarily;  
Open the door.  
**Result:** Cooking stops. To resume cooking, close the door and press again.

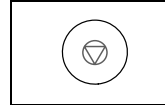

2. To stop Completely:  
Press the button.  
**Result:** The cooking stops.  
If you wish to cancel the cooking setting, press the Cancel() button again.



You can cancel any setting before you start cooking by simply pressing **Cancel**().

## Adjusting the Cooking Time

You can increase the cooking time by pressing the **+30s** button once for each 30 seconds to be added.

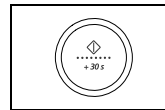

Press the **+30s** button once for each 30 seconds to be added.



You can only adjust the time during cooking when the Microwave, Auto Reheat/Cook, Cafeteria or Power Steam modes are selected.

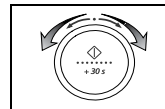

During the cooking, to increase or decrease the cooking time of your food, turn the **dial knob** right or left.

## Using the Auto Reheat Feature

The Auto Reheat feature has two pre-programmed cooking times. You do not need to set either the cooking times or the power level. You can adjust the number of servings by turning the dial knob. First, place the food in the centre of the turntable and close the door.

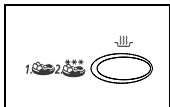

1. Select the type of food that you are cooking by pressing the **Auto Reheat** (Auto Reheat) button once or more times.

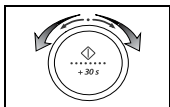

2. Select the size of the serving by turning the **dial knob**. (Refer to the table on the bottom.)

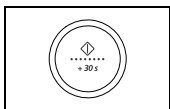



3. Press the  button  
**Result:** Cooking starts. When it has finished:
  - 1) The oven beeps four times.
  - 2) The end reminder signal will beep 3 times (once every minutes)
  - 3) The current time is displayed again.

 Use only recipients that are microwave-safe.

## Auto Reheat Settings

The following table presents the various Auto Reheat Programmes, quantities, standing times and appropriate recommendations.

Code/ Food	Serving Size	Standing Time	Recommendations
<b>1</b>  <b>Ready Meal</b> (Chilled)	300-350 g 400-450 g	3 min.	Put on a ceramic plate and cover with microwave cling film. This programme is suitable for meals consisting of 3 components (e.g. meat with sauce, vegetables and a side dishes like potatoes, rice or pasta).
<b>2</b>  <b>Ready Meal</b> (frozen)	300 - 350 g 400 - 450 g	4 min.	Take frozen ready meal and check if dish is suitable for microwave. Pierce film of ready meal. Put the frozen ready meal in the centre. This programme is suitable for frozen ready meals consisting of 3 components (e.g. meat with sauce, vegetables and a side dish like potatoes, rice or pasta).



## Using the Cafeteria Feature

With the Cafeteria feature, the cooking time is set automatically. You can adjust the number of servings by turning the dial knob. First, place the food in the centre of the turntable and close the door.

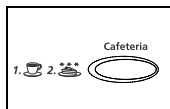

1. Select the type of food that you are cooking by pressing the **Cafeteria** button once or more times.



2. Select the size of the serving by turning the **dial knob**.



3. Press the  button.

**Result:** Cooking starts. When it has finished:

- 1) The oven beeps four times.
- 2) The end reminder signal will beep 3 times (once every minute)
- 3) The current time is displayed again.



**Example:** Press the **Cafeteria** button one times to reheat one cups of coffee and select the serving size by turning the **dial knob**. Refer to the table on the next page.

 Use only recipients that are microwave-safe.

## Cafeteria Settings

The following table presents Auto Programmes for reheating drinks and defrosting frozen cake pieces.

It contains its quantities, standing times and appropriate recommendations.

Button	Food	Serving Size	Standing Time	Recommendations
1 	<b>Drinks</b> Coffee, milk, tea, water (room-temperature)	150 ml (1 cup) 250 ml (1 mug)	1-2 min.	Pour into a ceramic cup (150 ml) or mug (250 ml) and place in the centre of turntable. Reheat uncovered. Stir carefully before and after standing time. Be careful while taking the cups out (see safety instructions for liquids).
2 	<b>Frozen Cake Pieces</b>	100 g (1pc) 200 g (2pcs) 300 g (2-3pcs) 400 g (3-4pcs) 500 g (4pcs)	5-15 min.	Put flat frozen cake pieces (-18°C) directly on metal rack. Put bigger pieces and muffins on turntable. Put one piece in the centre, put 2 pieces opposite to each other and 3-4 cake pieces in a circle. By the help of the heater the cake will be warmed and crisp up. This programme is suitable for cake pieces such as apple cake with crumble topping, streusel cake, cake with poppy seeds and muffins. It is not suitable for a whole cake, cake with cream filling and cake with chocolate topping.

## Using the Auto Power Defrost Feature

**The Auto Power Defrost feature enables you to defrost meat, poultry or fish. The defrost time and power level are set automatically.**

- ☒ Use only dishes that are microwave-safe.

**First, place the frozen food in the centre of the turntable and close the door.**

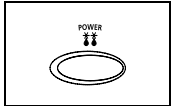

1. Press the **Auto Power Defrost** (⚡⚡) button.

**Result:** The following indication is displayed:

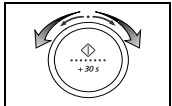

2. Select the food weight by turning the **dial knob**. It is possible to set up to a maximum of 1500g.



3. Press button.

**Result:**

- ◆ Defrosting begins.
- ◆ The oven beeps halfway through defrosting to remind you to turn the food over.
- ◆ Press button again to finish defrosting

- ☒ You can also defrost food manually. To do so, select the microwave cooking/reheating function with a power level of 180W. Refer to the section entitled “Cooking/Reheating” on page 6 for further details.

## Auto Power Defrost Settings

**The following table presents the Power Defrost programme, quantities, standing times and appropriate recommendations.**

**Remove all kind of package material before defrosting. Place meat, poultry and fish on a flat ceramic plate.**

Food	Portion	Standing Time	Recommendation
Meat, Poultry or Fish	200-1500g	15-60min.	Shield the edges with aluminium foil. Turn the pieces over, when the oven beeps. This programme is suitable for meat such as steaks, chops or minced meat, chicken pieces, whole chicken or fish fillets.

## Using the Power Steam Function

With the power steam feature, the cooking time is set automatically.

You can adjust the number of servings by turning the dial knob.

Use the plastic steam cooker when using power steam function.

First, place the plastic steam cooker in the centre of the turntable and close the door.



1. Select the type of food that you are cooking by pressing the **Power Steam** button once or more times.

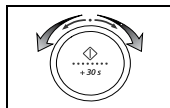

2. Select the size of the serving by turning the **dial knob**. (Refer to the table on the next page.)



3. Press the button.  
Result: Cooking starts. When it has finished:
  - 1) The oven beeps four times.
  - 2) The end reminder signal will beep 3 times (once every minute)
  - 3) The current time is displayed again.

Use only recipients that are microwave-safe.

## Using the Power Steam Function (continued)

The following table presents the 4 Auto Programs of the Power Steam function, quantities, standing times and appropriate recommendations. Use the plastic steam cooker when using power steam function.

GB

Code / Food	Serving Size	Standing Time	Recommendations
<b>1</b> <b>White Rice</b>	250 g 375 g	4-5 min.	Put white rice (parboiled) into the steam cooker. Add 500 ml cold water when cooking 250 g rice and add 750 ml water for 375 g rice. Close lid of steam cooker. After cooking remove moisture in the cavity by using kitchen paper.
<b>2</b> <b>Peeled Potatoes</b>	100-150 g 200-250 g 300-350 g 400-450 g 500-550 g	2-3 min.	Weigh the potatoes after peeling, washing and cutting into similar size. Put them into the steam cooker. Add 15-30 ml (1-2 tablespoons) water when steaming 100-350 g, add 45-60 ml (3-4 tablespoons) for 400-550 g. Close lid of steam cooker.
<b>3</b> <b>Fresh Vegetables</b>	100-150 g 200-250 g 300-350 g 400-450 g	1-2 min.	Weigh the vegetables after washing, cleaning and cutting into similar size. Put them into the steam cooker. Add 30 ml (2 tablespoons) water, when steaming 100-350 g, add 45 ml (3 tablespoons) for 400-450 g. Close lid of steam cooker. After steaming stir carefully before standing time.
<b>4</b> <b>Fruit Compote</b>	100-150 g 200-250 g 300-350 g 400-450 g	2-3 min.	Weigh the fresh fruits after peeling and washing and cut into similar slices or cubes. Put into steam cooker. When steaming 100-350g fruits add 15-30 ml (1-2 tbsp.) water, for 400-450 add 45ml (3 tbsp.). Additionally add 1-2 tbsp. sugar. Close lid of steam cooker. After steaming stir carefully. This programme is suitable for apples, pears, plums, apricots, mangoes or pineapple.

## Setting a Standing Time

**The Hold Time can be used to set a standing time automatically (without microwave cooking).**

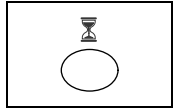

1. Press the  button.

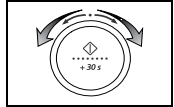

2. Select the standing time by turning the **dial knob**.





3. Press the  button.  
Result: Standing time starts. When it has finished:
  - 1) The oven beeps four times.
  - 2) The end reminder signal will beep 3 times (once every minute)
  - 3) The current time is displayed again.

## Using the Deodorization Feature

*Use this feature after cooking odorous food or when there is a lot of smoke in the oven interior.*

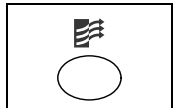
*First clean the oven interior.*



Press the **Deodorization** () button after you have finished cleaning. you will hear four beeps.

- ☒ The deodorization time has been specified as 5 minutes. It increases by 30 seconds whenever the **+30s** button is pressed.
- ☒ You can also adjust deodorization time by turning the dial knob right or left.
- ☒ The maximum deodorization time is 15 minutes.

## Switching the Beeper Off

*You can switch the beeper off whenever you want.*

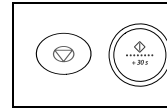



1. Press the  and  buttons at the same time.

Result:

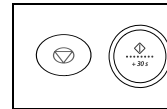
- ◆ The following indication is displayed.  

- ◆ The oven will not beep each time you press a button.



2. To switch the beeper back on, press the  and  buttons again at the same time.

Result:



- ◆ The following indication is displayed.  

- ◆ The oven operates with the beeper on again.

## Safety-Locking Your Microwave Oven

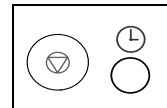
*Your microwave oven is fitted with a special Child Safety programme, which enables the oven to be “locked” so that children or anyone unfamiliar with it cannot operate it accidentally.*

*The oven can be locked at any time.*





1. Press the  and  buttons at the same time.

Result:

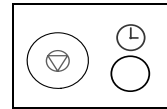
- ◆ The oven is locked (no functions can be selected).
- ◆ The display shows “L”.  



2. To unlock the oven, press the  and  buttons again at the same time.

Result: The oven can be used normally.

## Cookware Guide

To cook food in the microwave oven, the microwaves must be able to penetrate the food, without being reflected or absorbed by the dish used.

Care must therefore be taken when choosing the cookware. If the cookware is marked microwave-safe, you do not need to worry.

The following table lists various types of cookware and indicates whether and how they should be used in a microwave oven.

Cookware	Microwave-Safe	Comments
Aluminium foil	✓ X	Can be used in small quantities to protect areas against overcooking. Arcing can occur if the foil is too close to the oven wall or if too much foil is used.
Browning plate	✓	Do not preheat for more than eight minutes.
China and earthenware	✓	Porcelain, pottery, glazed earthenware and bone china are usually suitable, unless decorated with a metal trim.
Disposable polyester cardboard dishes	✓	Some frozen foods are packaged in these dishes.
<b>Fast-food packaging</b>		
• Polystyrene cups containers	✓	Can be used to warm food. Overheating may cause the polystyrene to melt.
• Paper bags or newspaper	X	May catch fire.
• Recycled paper or metal trims	X	May cause arcing.
<b>Glassware</b>		
• Oven-to-table ware	✓	Can be used, unless decorated with a metal trim.
• Fine glassware	✓	Can be used to warm foods or liquids. Delicate glass may break or crack if heated suddenly.
• Glass jars	✓	Must remove the lid. Suitable for warming only.

### Metal

- Dishes X May cause arcing or fire.
- Freezer bag twist ties X

### Paper

- Plates, cups, napkins and Kitchen paper ✓ For short cooking times and warming. Also to absorb excess moisture.
- Recycled paper X May cause arcing.

### Plastic

- Containers ✓ Particularly if heat-resistant thermoplastic. Some other plastics may warp or discolour at high temperatures. Do not use Melamine plastic.
- Cling film ✓ Can be used to retain moisture. Should not touch the food. Take care when removing the film as hot steam will escape.
- Freezer bags ✓ X Only if boilable or oven-proof. Should not be airtight. Prick with a fork, if necessary.

### Wax or grease-proof paper

- ✓ Can be used to retain moisture and prevent spattering.

✓ :Recommended

✓X :Use Caution

X :Unsafe

---

## Cleaning Your Microwave Oven

---

**GB** *The following parts of your microwave oven should be cleaned regularly to prevent grease and food particles from building up:*

- *Inside and outside surfaces*
- *Door and door seals*
- *Turntable and Roller rings*

☞ **ALWAYS** ensure that the door seals are clean and the door closes properly.

☞ Failure to maintain the oven in a clean condition could lead to deterioration of the surface that could adversely affect the of the appliance and possibly result in a hazardous situation.

1. Clean the outside surfaces with a soft cloth and warm, soapy water. Rinse and dry.
2. Remove any splashes or stains on the inside surfaces or on the roller ring with a soapy cloth. Rinse and dry.
3. To loosen hardened food particles and remove smells, place a cup of diluted lemon juice on the turntable and heat for ten minutes at maximum power.
4. Wash the dishwasher-safe plate whenever necessary.

☞ **DO NOT** spill water in the vents. NEVER use any abrasive products or chemical solvents. Take particular care when cleaning the door seals to ensure that no particles:

- Accumulate
- Prevent the door from closing correctly

---

## Storing and Repairing Your Microwave Oven

---

*A few simple precautions should be taken when storing or having your microwave oven serviced.*

*The oven must not be used if the door or door seals are damaged:*

- *Broken hinge*
- *Deteriorated seals*
- *Distorted or bent oven casing*

*Only a qualified microwave service technician should perform repair*

- ☞ **NEVER** remove the outer casing from the oven. If the oven is faulty and needs servicing or you are in doubt about its condition:
  - Unplug it from the wall socket
  - Contact the nearest after-sales service centre

☒ If you wish to store your oven away temporarily, choose a dry, dust-free place.

**Reason:** Dust and damp may adversely affect the working parts in the oven.

☒ This microwave oven is not intended for commercial use.

---

## Technical Specifications

---

*SAMSUNG strives to improve its products at all times. Both the design specifications and these user instructions are thus subject to change without notice.*

<b>Model</b>	<b>M187DN</b>
<b>Power source</b>	230V ~ 50 Hz
<b>Power consumption</b> Microwave	1250 W
<b>Output power</b>	100 W / 850 W (IEC-705)
<b>Operating frequency</b>	2450 MHz
<b>Magnetron</b>	OM75P(31)
<b>Cooling method</b>	Cooling fan motor
<b>Dimensions (W x H x D)</b> Outside Oven cavity	489 x 275 x 393 mm 330 x 211 x 329 mm
<b>Volume</b>	23 liter
<b>Weight</b> Net	13.5 kg approx

---

## Note

---



ELECTRONICS