

BEFORE USING THE WASHER

- In case of pump drained washer, remove the cap-hose from the drain hole.

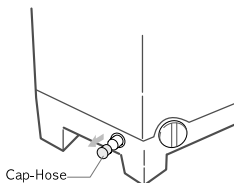

CAUTIONS

- **Be sure that the washer is grounded.**

To avoid electrical shock, use a metal pipe for the ground connection. But, don't ground the washer with gas pipes or telephone lines to avoid dangers of explosion or lightning strike.

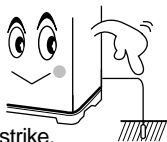

- **Do not put your hands into the spin dryer basket when it is spinning**

Your fingers can be caught by spinning laundry and damaged.



- **Never allow children to operate or play with the washer.**

Children playing with the washer may accidentally fall into the washing tub.



- **Disconnect the power cord from the power supply when not in use.**

- **Ventilation** opening must not be obstructed by carpeting when the washing machine is installed on a carpeted floor.

- **If the supply cord** of this appliance is damaged, it must only be replaced by a repair shop appointed by the manufacturer, because special purpose tools are required.

- **Warning** to avoid overfilling and damages this appliance must be filled with the operator present using a moderate water supply pressure only.

- **If the supply cord** is damaged, it must be replaced by the manufacturer or its service agent or a similarly qualified person in order to avoid a hazard.

- **The appliance** is to be connected to the water mains using new hose-sets and that old hose-sets should not be reused.

- **For washing machines** with ventilation openings in the base, that a carpet must not obstruct the openings.

PRECAUTIONS WHEN OPERATING

- **Don't use excessively hot water. (50°C or more)**

Plastic parts may be deformed or damaged. Also, clothing may be deformed or decolored.

- **Before washing, check all pockets.**

If nails or pins remain in pockets, they may damage the washer or clothes.

- **Close the water tap a little if the water pressure is too high.**

- **Be sure to cover with the inner cover on laundry before spinning.**

This prevents laundry from being tossed out and damaged.

- **To avoid water splashes, close the wash tub lid.**

- **Be sure lay the drain hose down (in case no drain pump)**

- **Never splash water on the control panel.**

DESCRIPTION OF PARTS

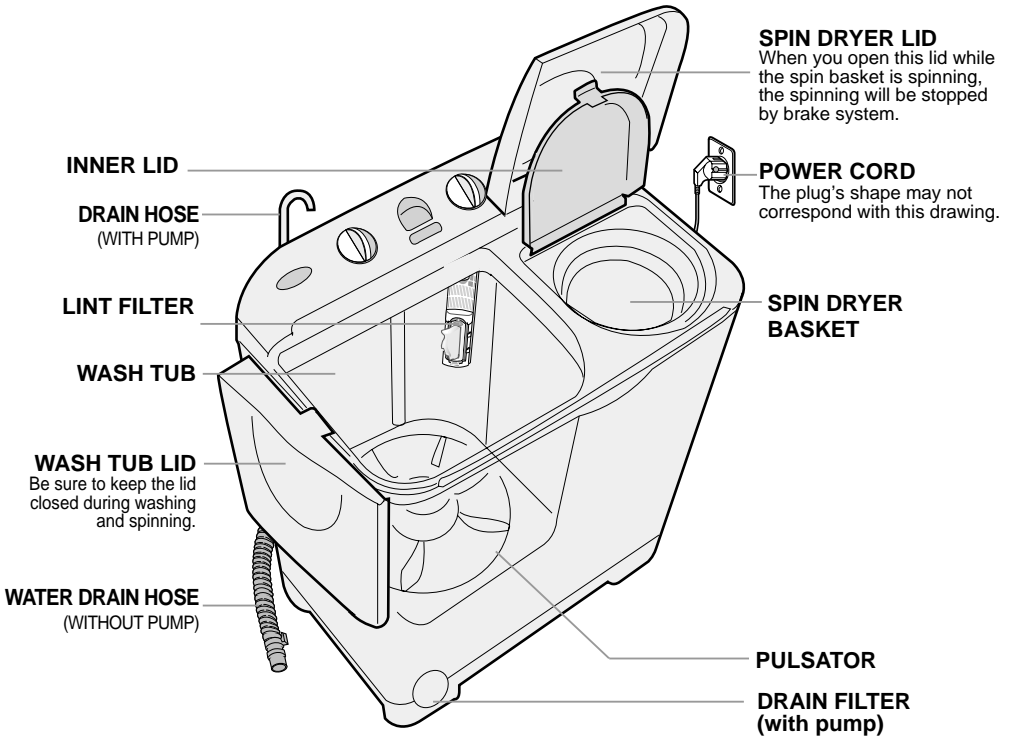

CONTROL PANEL

1. WASH SELECTOR

This is used to select wash action.

2. WASH TIMER

This is used to set the wash time, 1-15 minutes.

3. CYCLE SELECTOR

This is used to select the Washing / Rinsing or draining

4. SPIN DRY TIMER

This is used to set the spin time, 1-5 minutes.(or 1-10 minutes)

5.WATER SELECTOR

During washing, WATER SELECTOR KNOB should be selected to wash. During spin rinsing, WATER SELECTOR KNOB should be selected to spin.

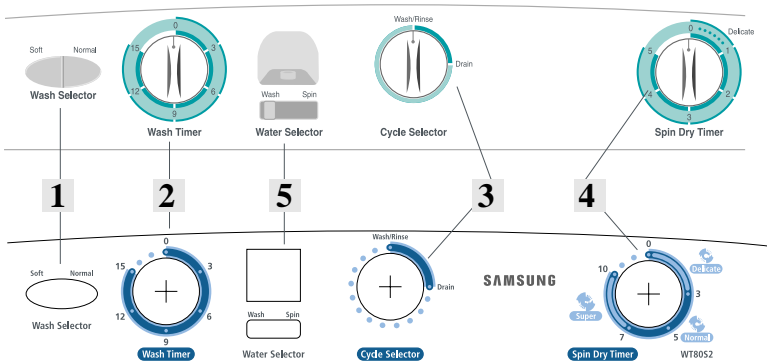

WASHING PROCEDURE

TO WASH

1. Before starting washing, check the following;

- Connect the water supply hose and open the water tap.
- Lay the drain hose down toward a sinkhole.
(In case no drain pump)
- Place the drain hose in sink or bath.
(In case drain pump)
- Connect the power cord to the power supply outlet.

2. Set the WASH SELECTOR KNOB to the desired mode.



3. Set the CYCLE SELECTOR KNOB to 'WASH · RINSE'. (In case drain pump "WASH")

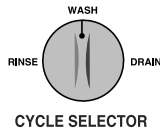
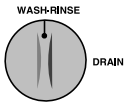

4. Set the WATER SELECTOR KNOB to WASH . FOR B TYPE



5. Load laundry in the wash tub.

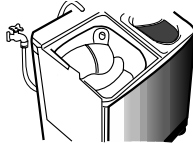

6. Fill water in the wash tub and add the detergent.



7. Set the WASH TIMER 1-15minutes.

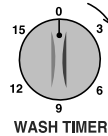

8. After washing, set the CYCLE SELECTOR KNOB to 'DRAIN' for drain.

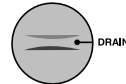

SPIN DRY

1. Transfer the clothes into the spin basket and arrange the clothes evenly.



2. Be sure to attach the safety cover and close the inner lid.

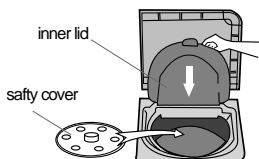

3. Close the spin dryer lid.

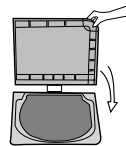

4. Set the SPIN DRY TIMER 1-5minutes. (or 1-10minutes)



RINSING

1. Set the **CYCLE SELECTOR KNOB** to 'WASH RINSE'. (In case drain pump "WASH")

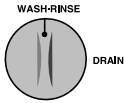

CYCLE SELECTOR

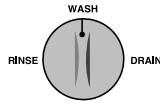

CYCLE SELECTOR

2. Supply the proper amount of water as not to overflow the top of the washing tub.

3. Set the **WASH TIMER** 2~3minutes.



WASH TIMER

4. Drain the water. Set the **CYCLE SELECTOR KNOB** to 'DRAIN'.

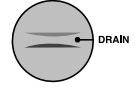

CYCLE SELECTOR

5. Repeat this cycle until drain water is clean. (2~3 cycles)

OVER FLOW RINSE

1. Keep supplying water



Adjust water pressure to ensure that the amount of water supplied does not exceed that water drained.

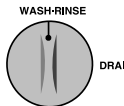

CYCLE SELECTOR
(Without pump)

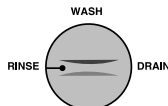

CYCLE SELECTOR
(With pump)

2. Set the **WASH TIMER** 6~8minutes.



WASH TIMER

3. As soon as the **WASH TIMER** shuts off, turn off the water tap.

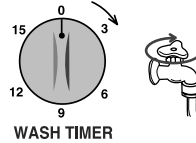

WASH TIMER

4. Set the **CYCLE SELECTOR KNOB** to 'DRAIN'.

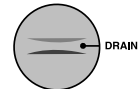

CYCLE SELECTOR

ADDITIONAL RINSE

- 1 After rinsing you can select this course for more effective rinse (Don't select only this course for rinse.) Load the laundry evenly into the spin basket.



- 2 Set the **WATER SELECTOR KNOB** to SPIN and **CYCLE SELECTOR KNOB** to 'DRAIN'.



CYCLE SELECTOR

- 3 Supply water for about 1minute. Adjust the water flow to prevent overflow from the wash tub.



1 min.

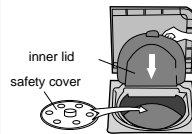

- 4 After stopping water supply, cover the laundry with safety cover and close the inner lid.

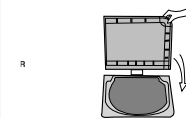

- 5 Close the spin dryer lid.

- 3 Supply water for about 1minute. Adjust the water flow to prevent overflow from the wash tub.

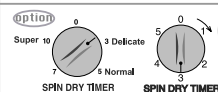

SPIN DRY TIMER

- 6 Set the **SPIN DRY TIMER** 2~3 minutes.

INSTALLATION

ENVIRONMENT

Leave some space

Space at last 15cm between the washer and the wall.

Place the washer on a sturdy flat surface.

If the washer is placed on an uneven or weak surface, noise or vibration may be occurred. (Allowable is 2°)

Never install the washer near water.

Do not place the washer in steamy rooms or where the washer is directly exposed to rain. Moisture may destroy the electrical insulation and cause an electrical shock hazard.

Avoid direct sunlight or heating devices.

As plastic and electrical components are affected by direct heat, never place the washer near heaters, boilers, etc. Do not place under direct sunlight.

Install the drain hose about 70~80cm above the ground for pump model.

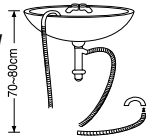

HOW TO CLEAN THE FILTER (In case drain pump)

1. Place a rag under the washer filter not to wet the floor.
2. Rotate the filter counterclockwise and pull out the filter.
3. Remove dirt and rotate the filter clockwise until it locks in position.

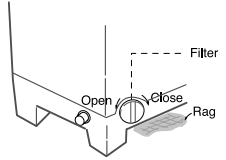

CONNECTING THE DRAIN HOSE

After pressing the joint ring(a), insert the drain hose(b) to drain direction.

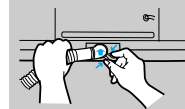
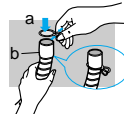

CLEANING THE MACHINE

CLEANING THE LINT FILTER

If the dregs are filled up in the lint filter after finishing the wash, push down and pull it out as shown in figure.

Remove the collected lint and rinse the filter net.



OVERFLOW FILTER

Pull the upper side of the overflow filter with two fingers into the hole 'A' in the direction of arrow as shown in the figure.

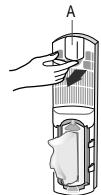

CLEANING THE WASH TUB

Wipe off strains on the cabinet and operation panel with soft cloth.

Do not use benzene, thinners, cleanser, or wax, nor scrub the washer with a brush.

Painted surfaces or plastic parts will be damaged.

LAUNDRY GUIDE

WASHING TIME

KINDS OF CLOTHING	WASHING TIME	WASHING SELECTION
Extremely solid heavy fabric	10 to 15 minutes	NORMAL
Linen, cotton, etc.	8 to 10 minutes	
Ordinary clothes (underwear, etc)	7 minutes	SOFT
Slightly soiled synthetic fiber	2 to 5 minutes	
100% wool, mixed wool knitting, thin synthetic fiber with tags indicating hand washing	2 to 5 minutes	

SPIN DRY TIME

TIME	TYPE OF LAUNDRY
1 min.	Thin (synthetic fiber)
1~2 min.	wool
3~5 min.	cotton
5 min.	thick (cotton)

DETERGENT

AMOUNT OF DETERGENT	WATER LEVEL
37 g	Low (37l)
45 g	Mid (45l)
54 g	High (54l)

The amount of detergent is average. Follow the instruction detergent printed on the package for amount of detergent. Choose the amount of detergent depending on the fabric type.

MAINTENANCE

WHEN YOU LOAD THE LAUNDRY INTO THE SPIN BASKET.

Press the laundry evenly and put the safety cover into the spin basket drum as shown in the figure.

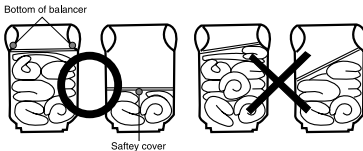

TO PICK OUT THE CLOTHING WHICH HAS FALLEN BETWEEN THE BASKET AND TUB.

For safety, pull the power supply plug out of the socket.

1. Disassemble a screw from the spin dryer hatch.
2. The spin dryer hatch is fixed to the brim by the concave and convex parts at two places. Expand the concave and convex parts, and pull up the spin dryer hatch to remove it.
3. Remove the clothing
4. Close the spin dryer hatch. Push in hatch firmly until the catch at the front is engaged securely.

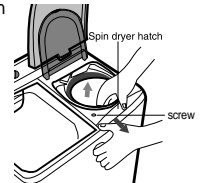

TROUBLE SHOOTING

TROUBLE	CHECK POINT	TROUBLE	CHECK POINT
The washer does not work.	Check that the power cord is connected to a power outlet well. Power stoppage?	Incomplete draining	Is the filter clogged with lint?
Clothes will not move freely.	Is the laundry overloaded?	The spin dryer basket will not run.	Is the spin dryer lid closed completely? Are laundry (socks, etc.) falling out of the spin dryer basket and clinging to the axle? ○ See "To pick out..." on page 6.
Incomplete spinning	Are the laundry arranged evenly?		

S A M S U N G

Owner's Instructions

SWT80H0(P)/SWT80H1(P)/SWT80H2(P)

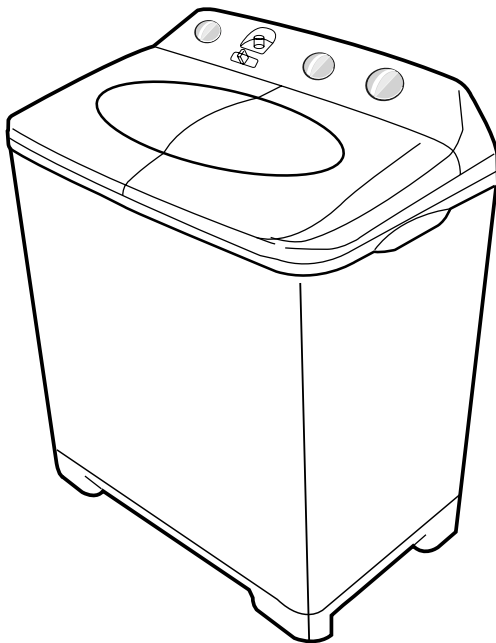

Before operating the unit, please read this manual thoroughly, and retain for future reference.

BEFORE USING THE WASHER	1
CAUTIONS	1
PRECAUTIONS WHEN OPERATING	1
DESCRIPTION OF PARTS	2
CONTROL PANEL	2
WASHING PROCEDURE	3
TO WASH	3
SPIN DRY	3
RINSING	4
OVER FLOW RINSE	4
ADDITIONAL RINSE	4
INSTALLATION	5
ENVIRONMENT	5
HOW TO CLEAN THE FILTER	5
CONNECTING DRAIN HOSE	5
CLEANING THE MACHINE	5
LAUNDRY GUIDE	6
MAINTENANCE	6
TROUBLESHOOTING	6
SPECIFICATIONS	6

IF YOU NEED HELP.

Do not hesitate to call your local samsung service center.

They will be willing to help you.

Be sure to give them your name, address, telephone number and the purpose of the call.

SPECIFICATION

DIMENSIONS (W x D x H)mm		792 x 465 x 951
WATER PRESSURE		0.05~0.78 MPa 0.5 ~ 8.0 kg-f/cm ²
WEIGHT	With out pump	29 kg
	With pump	31 kg
EXTRACTION EFFICIENCY		50 %
STANDARD QUANTITY OF WATER		54l
NOMAL CAPACITY	Washing	6.0kg
	Spinning	6.0kg
MOTOR INPUT	Washing	340W
	Spinning	200W
MOTOR MAX INPUT		480W
RATING TIME		Washing 1Hour Spinning 15minutes