

SAMSUNG

COLOR TELEVISION

SP43T6/54T6

SP43T7

SP43T8/54T8/62T8

SP43T9/54T9

SP43Q1

Owner's Instructions

Before operating the unit,
please read this manual thoroughly,
and retain it for future reference.

**PICTURE IN PICTURE (PIP)
TELETEXT
SELF FOCUS**

DNie™

SRS 
TruSurround XT

Important Warranty Information Regarding Television Format Viewing

Standard screen format televisions (4:3, the aspect ratio of the screen width to height) are primarily designed to view standard format full-motion video. The images displayed on them should primarily be in the standard 4:3 ratio format and constantly moving. Displaying stationary graphics and images on screen, such as the dark top and bottom letterbox bars (wide screen pictures), should be limited to no more than 15% of the total television viewing per week.

Wide screen format televisions (16:9, the aspect ratio of the screen width to height) are primarily designed to view wide screen format full-motion video. The images displayed on them should primarily be in the wide screen 16:9 ratio format, or expanded to fill the screen if your model offers this feature, and constantly moving. Displaying stationary graphics and images on screen, such as the dark side-bars on non-expanded standard format television video and programming, should be limited to no more than 15% of the total television viewing per week.

Additionally, viewing other stationary images and text such as stock market reports, video game displays, station logos, web sites or computer graphics and patterns, should be limited as described above for all televisions. *Displaying any stationary images that exceed the above guidelines can cause uneven aging of picture tubes (CRTs) that leave subtle, but permanent burned-in ghost images in the television picture. To avoid this, vary the programming and images, and primarily display full screen moving images, not stationary patterns or dark bars.* On television models that offer picture sizing features, use these controls to view the different formats as a full screen picture.

Be careful in the selection and duration of television formats used for viewing. Uneven CRT aging as a result of format selection and use, as well as other burned-in images, is not covered by your Samsung limited warranty.

Contents

◆ FOREWORD	
■ Important Warranty Information Regarding Television Format Viewing.....	3
◆ CONNECTING AND PREPARING YOUR TELEVISION	
■ Control Panel (depending on the model).....	6~7
■ Connection Panel	8
■ Using a Display Deck (depending on the model)	9
■ Infrared Remote Control.....	10
■ Inserting the Batteries in the Remote Control.....	11
■ Connecting to an Aerial or Cable Television Network	11
■ Connecting a Satellite Receiver or Decoder.....	12
■ Switching Your Television On and Off.....	13
■ Placing Your Television in Standby Mode.....	14
■ Becoming Familiar with the Remote Control	15
■ Plug & Play Feature	16~17
■ Displaying Information	18
■ Choosing Your Language.....	18
■ Adjusting the Screen Automatically (Self Focus).....	19
■ Deactivating the Automatic Execution of the Self Focus	20
■ Removing the “Self Focus” from the Display	21
◆ SETTING THE CHANNELS	
■ Storing Channels Automatically.....	22
■ Sorting the Stored Channels	23
■ Storing Channels Manually.....	24~25
■ Skipping Unwanted Channels	26
■ Locking the Channel.....	27
■ Fine Tuning Channel Reception	28
◆ USING YOUR TELEVISION	
■ Using the LNA (Low Noise Amplifier) Feature.....	29
■ Viewing the Channel Scan Picture	30
■ Changing the Picture Standard	31
■ Customizing the Picture Settings.....	32
■ Selecting the Picture Size (4:3 Model)	33
■ Selecting the Picture Size (Wide Model)	34~35
■ Selecting the Scan Mode.....	36
■ Using the Digital NR (Digital Noise Reduction) Feature	37
■ Freezing the Current Picture	37
■ DNIe™ (Digital Natural Image engine) DNIe™	38

Contents (continued)

◆ USING YOUR TELEVISION (continued)	
■ Setting the Blue Screen Mode.....	39
■ Viewing the Picture In Picture (PIP)	40~41
■ Changing the Sound Standard	42
■ Adjusting the Sound Settings	43
■ Adjusting the Volume Automatically	44
■ Setting the TruSurround XT.....	45
■ Setting the Melody Sound	46
■ Selecting the Sound Mode (depending on the model)	47
■ Setting and Displaying the Current Time.....	48
■ Setting the Sleep Timer	49
■ Switching the Television On and Off Automatically	50
■ Viewing an External Signal Source	51
◆ USING THE TELETEXT FEATURE	
■ Teletext Feature	52
■ Displaying the Teletext Information	53
■ Selecting Display Options.....	54
■ Selecting a Teletext Page.....	55
■ Storing Teletext Pages (depending on the model)	56
◆ ADDITIONAL INFORMATION AND CONNECTIONS	
■ Connecting to the External Devices	57
■ Connecting to the Audio Output	58
■ Connecting to the S-Video Input.....	59
■ Connecting to the Component Input.....	59
◆ RECOMMENDATIONS FOR USE	
■ Programming the Remote Control for Other Components	60~62
- VCR Remote Control Codes	61
- Cable Box (CATV) Remote Control Codes	62
- DVD Remote Control Codes	62
■ Troubleshooting: Before Contacting Service Personnel.....	63

Symbols



Press



Important



Note

Control Panel (depending on the model)

➤ The actual configuration on your TV may be different, depending on your model.

SP43T6
SP54T6

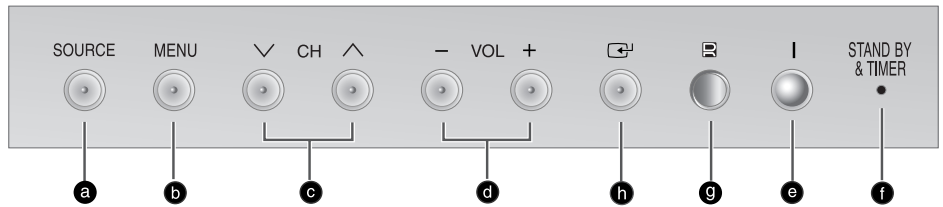

SP43T7

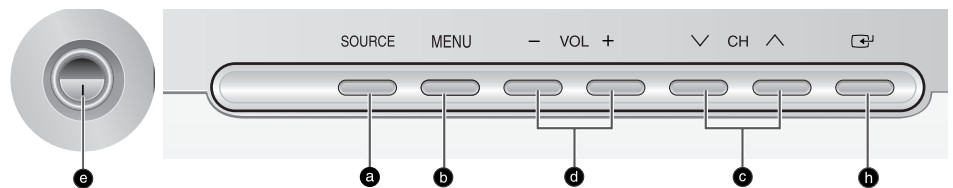

SP43T8
SP54T8
SP62T8

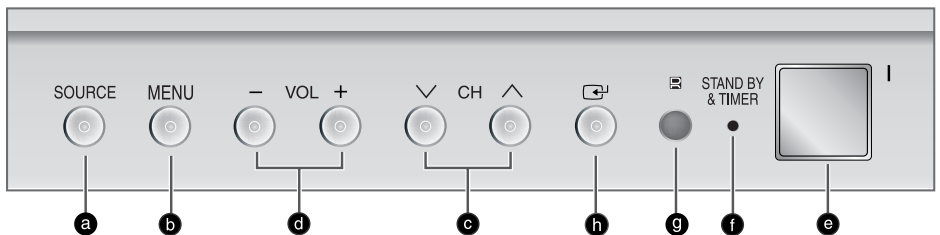

- | | |
|------------------------------------|--|
| (a) Switch among video input modes | (f) Standby & Timer Indicator |
| (b) Display the on-screen menu | (g) Remote control sensor |
| (c) Select the channels | (h) Access to the selected option on the menu system |
| (d) Adjust the volume | |
| (e) Switch the TV on and off | |

-
- ◆ You can use the \wedge CH \vee buttons to switch on the TV when it is in standby mode depending on the model.
 - ◆ The - VOL + and \wedge CH \vee buttons have the same function as the \blacktriangle / \blacktriangledown / \blacktriangleleft / \blacktriangleright buttons on the remote control.
 - ◆ If the remote control no longer works or you have lost it, you can use controls on the panel of the TV.

Control Panel (depending on the model) (continued)

➤ The actual configuration on your TV may be different, depending on your model.

SP43Q1

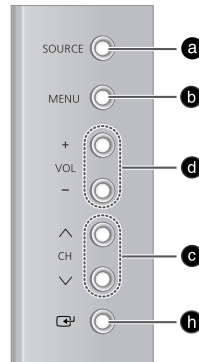
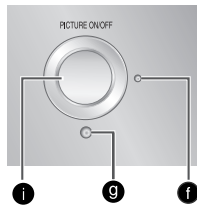

SP43T9
SP54T9

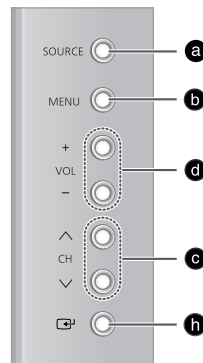
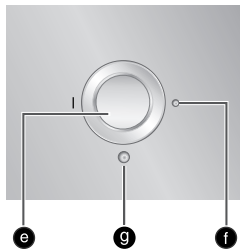

- | | |
|------------------------------------|--|
| (a) Switch among video input modes | (f) Standby & Timer Indicator |
| (b) Display the on-screen menu | (g) Remote control sensor |
| (c) Select the channels | (h) Access to the selected option on the menu system |
| (d) Adjust the volume | (i) Place the TV in standby mode |
| (e) Switch the TV on and off | |

Connection Panel

➤ The actual configuration on your TV may be different, depending on your model.

Side of the TV

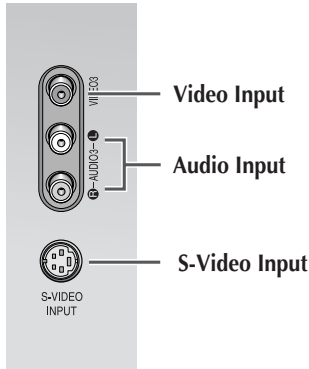

Front of the TV

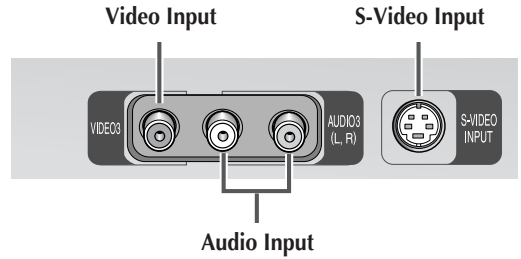

Rear of the TV

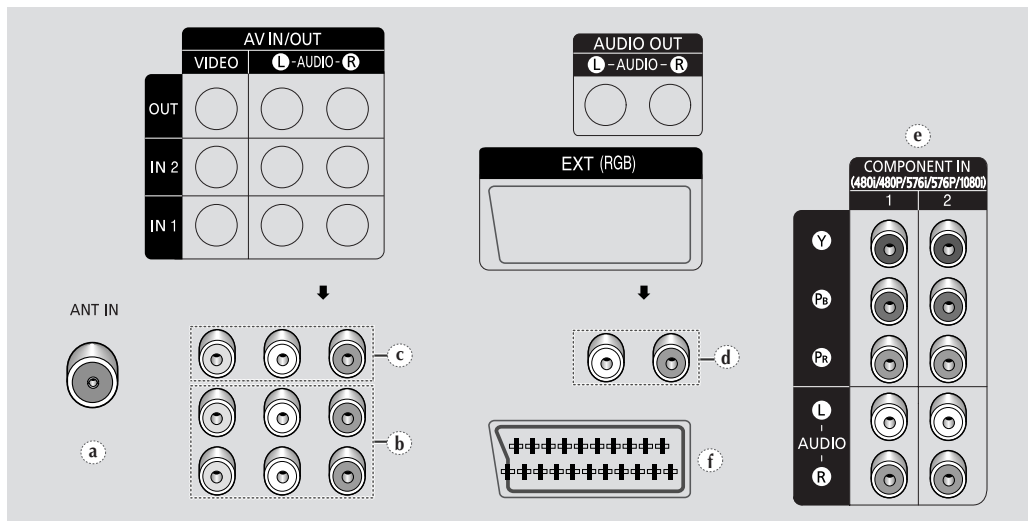

- | | |
|-------------------------------------|--------------------------------------|
| (a) ANT IN VHF/UHF (75Ω) | (d) AUDIO OUTPUT |
| (b) AV INPUT (VIDEO/L-AUDIO-R)-1, 2 | (e) COMPONENT VIDEO/AUDIO INPUT-1, 2 |
| (c) AV OUTPUT (VIDEO / L-AUDIO-R) | (f) AV INPUT OR OUTPUT |

➤ For further details about connection, refer to pages 57~59.

👉 Whenever you connect an audio or video system to your television, ensure that all elements are switched off. Refer to the documentation supplied with your equipment for detailed connection instructions and associated safety precautions.

Using a Display Deck (depending on the model)

You can display a VCR or DVD Player, etc. by using the display deck.

SP54T8/62T8

- 1 Hold the center of the door and lift it up in the direction of arrow.
- 2 After placing a component you have in the display deck, hold the center of the door and pull it down.

➤ You should display only the component that is within 126mm high. When displaying a component in the display deck, please space it out 30mm from the front, 20mm from either end.

SP54T8/62T8

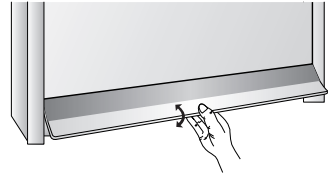

SP43Q1



SP43T9/54T9

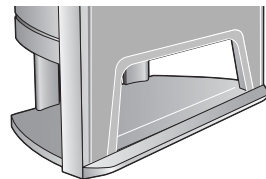

Infrared Remote Control

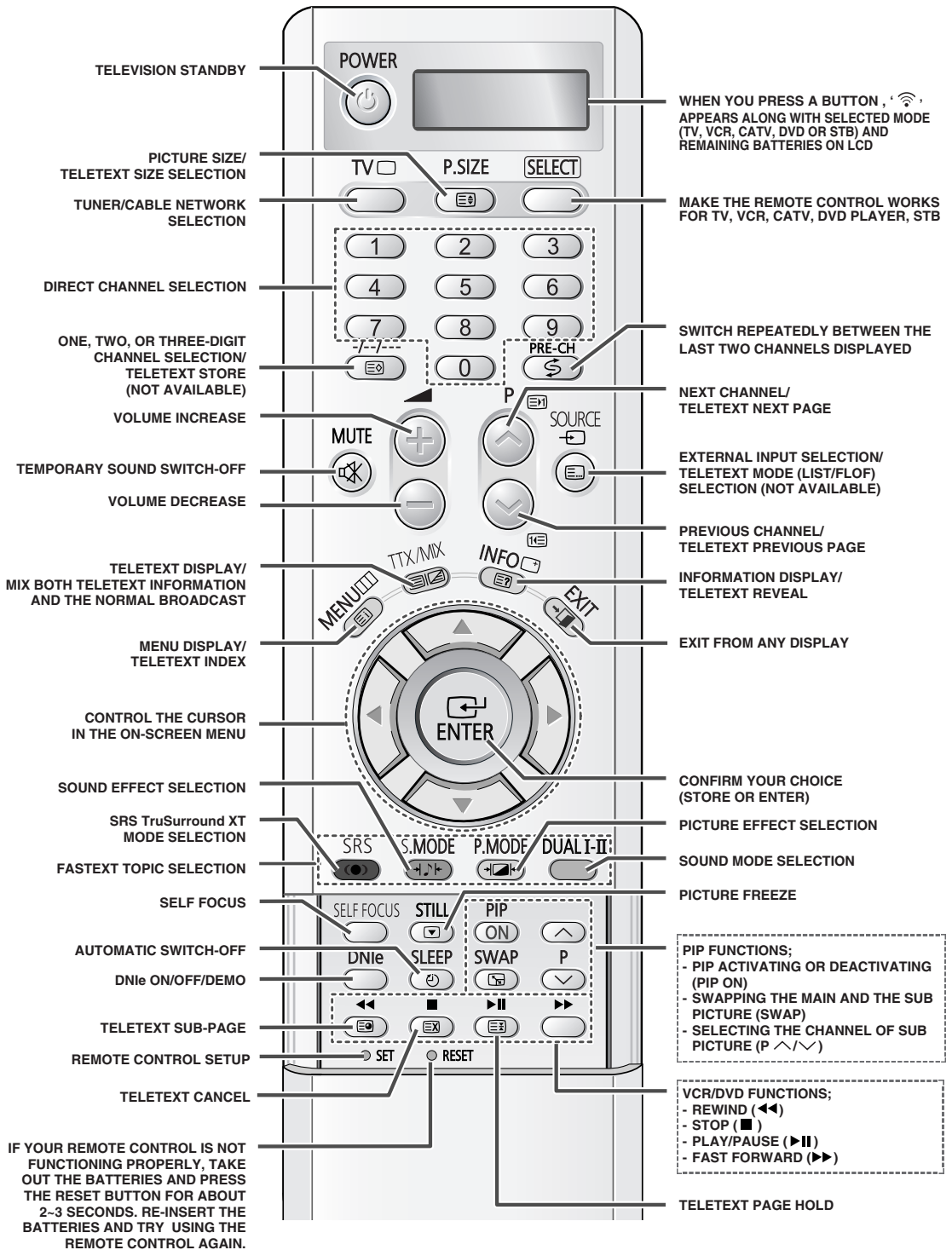

➤ The performance of the remote control may be affected by bright light.

Inserting the Batteries in the Remote Control

You must insert or replace the batteries in the remote control when you:

- ◆ *Purchase the television*
- ◆ *Find that the remote control is no longer operating correctly*

- 1 Remove the cover on the rear of the remote control by pressing the symbol (▼) downwards and then pulling firmly to remove it.
- 2 Insert two R03, UM4, "AAA" 1.5V or equivalent batteries taking care to respect the polarities:
 - ◆ - on the battery against - on the remote control
 - ◆ + on the battery against + on the remote control
- 3 Replace the cover by aligning it with the base of the remote control and pressing it back into place.

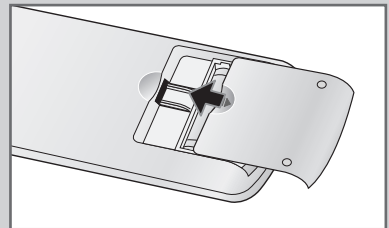
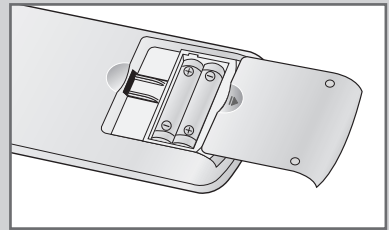
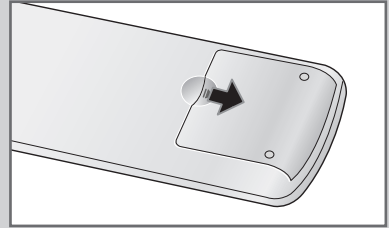

Connecting to an Aerial or Cable Television Network

To view television channels correctly, a signal must be received by the set from one of the following sources:

- ◆ *An outdoor aerial*
- ◆ *A cable television network*
- ◆ *A satellite network*

- 1 In the first three cases, connect the aerial or network input cable to the 75Ω coaxial socket on the rear of the television.
- 2 If you are using an indoor aerial, you may need to turn it when tuning your television until you obtain a picture that is both sharp and clear.
For further details, refer to:
 - ◆ "Storing Channels Automatically" on page 22.
 - ◆ "Storing Channels Manually" on page 24.

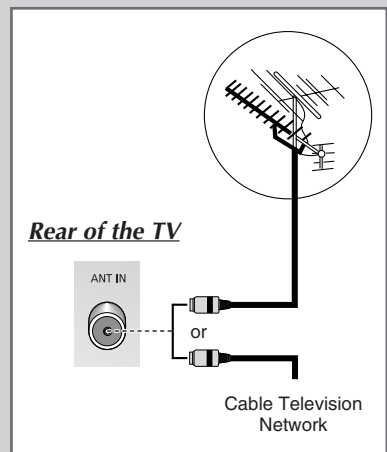

Connecting a Satellite Receiver or Decoder

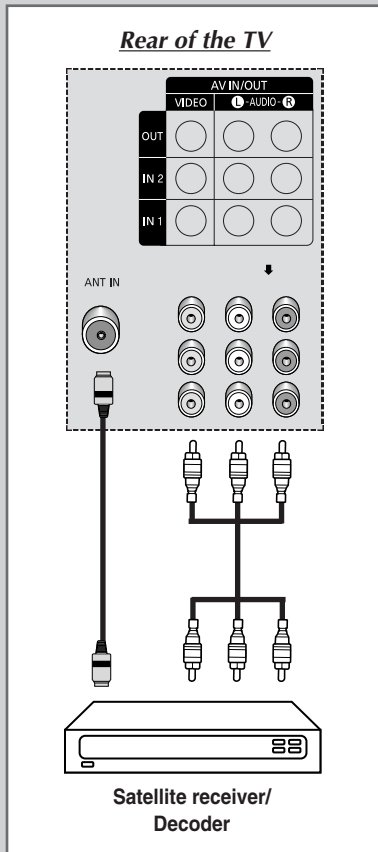

In order to watch television programmes broadcast via a satellite network, you must connect a satellite receiver to the rear of TV. Also, in order to descramble a coded transmission signal, you must connect a decoder to the rear of TV.

Using a Coaxial cable

Connect a coaxial cable to the:

- ◆ Receiver (or Decoder) output socket.
- ◆ Television aerial input socket.

➤ If you wish to connect both a satellite receiver (or decoder) and a VCR, you should connect the:

- ◆ Receiver (or Decoder) to the VCR
- ◆ VCR to the television

Otherwise, connect the receiver (or decoder) directly to the television.

Switching Your Television On and Off

The mains lead is attached to the rear of your television.

- 1 Plug the mains lead into an appropriate socket.
 - The main voltage is indicated on the rear of the television and the frequency is 50 or 60Hz.
- 2 Press the “I” button (On/Off) on the front of the television.

Result: The Standby indicator on the front of the television lights up.
- 3 Press the **POWER** (⏻) button on the remote control to switch the television on.

Result: The programme that you were watching last is re-selected automatically.

 - ◆ If your television isn't turned on when the **POWER** (⏻) button is pressed, press the **SELECT** button to check if the “TV” mode has been chosen.
 - ◆ If you have not yet stored any channels, No clear picture appears. Refer to “Storing Channels Automatically” on page 22 or “Storing Channels Manually” on page 24.
- 4 To switch your television off, press the “I” button (On/Off) again.

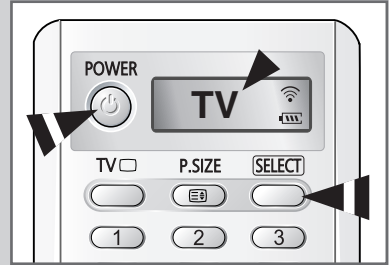

Placing Your Television in Standby Mode

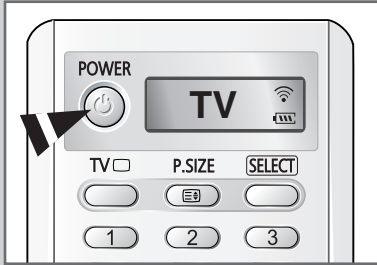

Your television can be placed in Standby mode, in order to reduce the power consumption.

The Standby mode can be useful when you wish to interrupt viewing temporarily (during a meal, for example).

- 1 Press the **POWER** (⏻) button on the remote control.

Result: The screen is turned off and the Standby indicator on the front of the television lights up.

- 2 To switch the television back on, simply press the **POWER** (⏻) button again or a numeric button.

➤ You can also switch on by pressing the **TV** (□) or **P** (⏻/⏻) button.













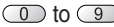



- ☞ Do not leave your television in Standby mode for long periods of time (when you are away on holiday, for example). Turn your television off by pressing the "I" button (On/Off) on the front of the television. It is best to unplug the set from the mains and aerial.

Becoming Familiar with the Remote Control

The remote control is used mainly to:

- ◆ Change channels and adjust the volume
- ◆ Set up the television using the on-screen menu system

The following table presents the most frequently used buttons and their functions.

Button	Viewing Function	Menu Function
	Used to display the next stored channel.	-
	Used to display the previous stored channel.	-
 to 	Used to display the corresponding channels. ➤ For double digit channels, the second digit must be pushed immediately after the first. Failure to do this will result in a single digit channel being displayed.	-
	Used to select a channel numbered ten or over. Press this button, and the "--" or "---" symbol is displayed. Enter the two or three-digit channel number.	-
PRE-CH ()	Press the PRE-CH button. The TV will switch to the last channel viewed. To quickly switch between two channels that are far apart, tune to one channel, then use the numeric buttons to select second channel. Then, use the PRE-CH button to quickly alternate between them.	-
	Used to increase the volume.	-
	Used to decrease the volume.	-
MUTE ()	Used to switch the sound off temporarily. ➤ To turn the sound back on, press this button again, or press the  or  button.	-
MENU ()	Used to display the on-screen menu system.	Used to return to the previous menu or normal viewing.
	-	Used to: ◆ Display a submenu containing selections for the current menu option. ◆ Increase/decrease a menu option value.
	-	Used to confirm your choice.
TV ()	Used to switch the television on when it is in Standby mode.	Used to exit from the menu system and return to normal viewing directly.
EXIT ()	-	Used to exit from the any display.

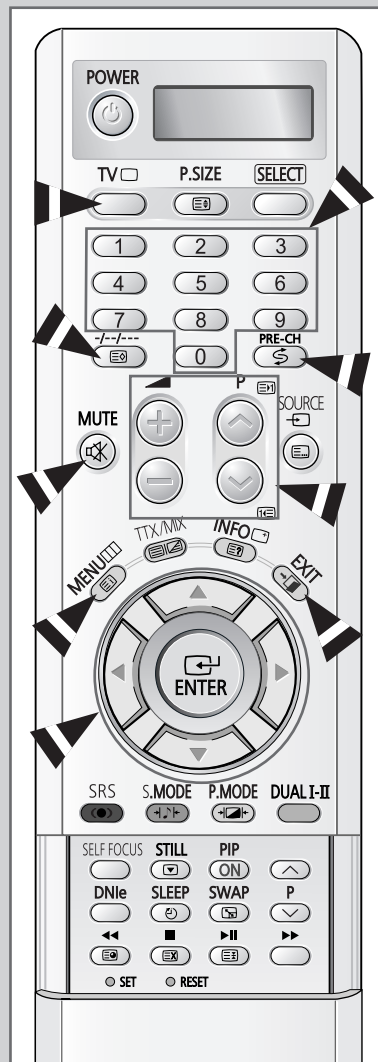

Plug & Play Feature

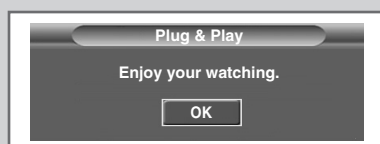
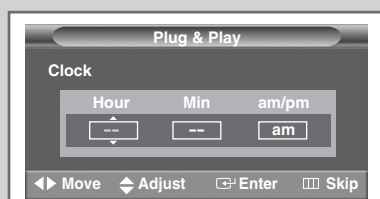

When the television is initially powered ON, several basic customer settings proceed automatically and subsequently. The following settings are available.

- 1 If the television is in Standby mode, press the **POWER** (⏻) button on the remote control.

Result: The message **Start Plug & Play** is displayed.

- 2 To start the Plug & Play, press the **ENTER** (↵) button.

Result: The **Language** menu is displayed.

- 3 Select the appropriate language by pressing the **▲** or **▼** button. Press the **ENTER** (↵) button to confirm your choice.

Result: The message **Check antenna input** is displayed.

- 4 Make sure that the antenna is connected to the TV, and then press the **ENTER** (↵) button.

Result: The **Area** menu is displayed.

- 5 Select your area by pressing the **▲** or **▼** button. Press the **ENTER** (↵) button to confirm your choice.

Result: The **Auto Store** menu is displayed.

- 6 To start the channel store, press the **ENTER** (↵) button.

Result: The search will end automatically. Channels are sorted and stored in an order which reflects their position in the frequency range (with lowest first and highest last). When it has finished, the **CLock** menu is displayed.

➤ To stop the search before it has finished or return to normal viewing, press the **MENU** (⏻) button.

- 7 Press the **◀** or **▶** button to move to the **Hour**, **Min** or **am/pm**. Set these by pressing the **▲** or **▼** button.



➤ You can also set the **Hour** and **Min** by pressing the numeric buttons directly.

- 8 Press the **ENTER** (↵) button.

- 9 When the setting has finished all, the message **Enjoy your watching.** is displayed, and then the channel which has been stored will be activated.

Plug & Play Feature (continued)

If you want to reset this feature...

- 1 Press the **MENU** () button.
Result: The main menu is displayed.
- 2 Press the **▲** or **▼** button until the **Setup** is selected.
Result: The options available in the **Setup** group are displayed.
- 3 Press the **ENTER** () button.
- 4 Press the **▲** or **▼** button until the **Plug & Play** option is selected.
Press the **ENTER** () button.
Result: The message **Start Plug & Play** is displayed.
- 5 For further details on how to set, refer to the opposite page.



Displaying Information



You can view the channel information and setting status you select by pressing the “INFO (□)” button on the remote control.

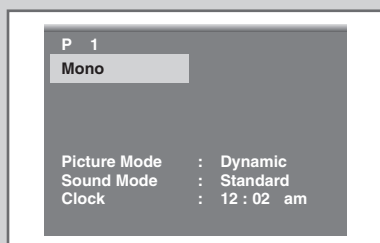

Choosing Your Language



When you start using your television for the first time, you must select the language which will be used for displaying menus and indications.

- 1 Press the **MENU** (□) button.
Result: The main menu is displayed.
- 2 Press the **▲** or **▼** button until the **Setup** is selected.
Result: The options available in the **Setup** group are displayed.
- 3 Press the **ENTER** (↵) button.
- 4 Press the **▲** or **▼** button until the **Language** is selected. Press the **ENTER** (↵) button.
Result: The languages available are listed.
- 5 Select the appropriate language by pressing the **▲** or **▼** button. Press the **ENTER** (↵) button to confirm your choice.



Adjusting the Screen Automatically (Self Focus)

The "Self Focus" feature automatically finds the optimum picture quality when blurring, overlapping colors or incorrect focus occurs. These conditions may be caused by moving your TV.

- 1 Press the **MENU** () button.

Result: The main menu is displayed.

- 2 Press the **▲** or **▼** button until the **Setup** is selected.

Result: The options available in the **Setup** group are displayed.

- 3 Press the **ENTER** () button.

- 4 Press the **▲** or **▼** button until the **Self Focus** is selected. Press the **ENTER** () button.

Result: The **Self Focus** is selected.

- 5 Press the **ENTER** () button again

Result: The self focus process begins with the message **Self Focus** and horizontal bar is displayed. During the process, minor distortions of the picture may occur. At this time, the colors may diffuse and a searching action will appear on the edges of the screen. This is a normal part of the adjustment. When it is finished, all of things will disappear and the optimum picture quality can be enjoyed.

➤ You can also set these options simply by pressing the **SELF FOCUS** button.



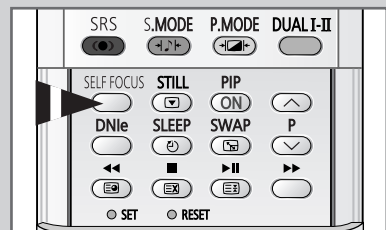
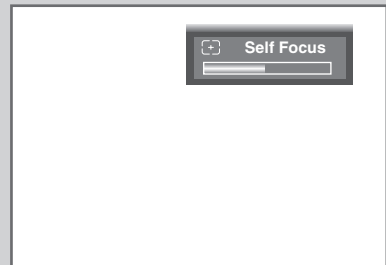

- ◆ Changing channels and any other signal changes will pause the self focus until a stable signal has returned. It resumes after the signal has been stabilised. This feature will not work without a signal.
- ◆ Ambient light that is too bright may affect the self focus. If this occurs, darken the environment and try again.







Deactivating the Automatic Execution of the Self Focus



The “Self Focus” feature starts on default. It will automatically begin 10 minutes after switching on the power and the appearance of the screen image. To set the optimum picture quality, the “Self Focus” will automatically begin again after another 30 minutes, as the screen image is then fully stabilised.

- 1 Press the **MENU** () button.
Result: The main menu is displayed.
- 2 Press the **▲** or **▼** button until the **Setup** is selected.
Result: The options available in the **Setup** group are displayed.
- 3 Press the **ENTER** () button.
- 4 Press the **▲** or **▼** button until the **Self Focus** is selected.
Press the **ENTER** () button.
Result: The options available in the **Self Focus** group are displayed.
- 5 Press the **▲** or **▼** button until the **Auto** is selected.
Press the **ENTER** () button.
- 6 To turn off the automatic execution of the self focus feature, select **off** by pressing the **▲** or **▼** button. Press the **ENTER** () button to confirm.

Removing the "Self Focus" from the Display



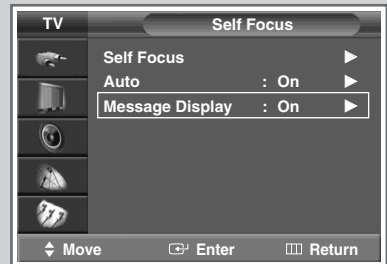





- 1 Press the **MENU** () button.
Result: The main menu is displayed.
- 2 Press the **▲** or **▼** button until the **Setup** is selected.
Result: The options available in the **Setup** group are displayed.
- 3 Press the **ENTER** () button.
- 4 Press the **▲** or **▼** button until the **Self Focus** is selected.
Press the **ENTER** () button.
Result: The options available in the **Self Focus** group are displayed.
- 5 Press the **▲** or **▼** button until the **Message Display** is selected.
Press the **ENTER** () button.
- 6 To remove the message **Self Focus** and horizontal bar on the screen during the self focus process, select **Off** by pressing the **▲** or **▼** button. Press the **ENTER** () button to confirm.



Storing Channels Automatically







You can scan for the frequency ranges available to you, (availability depends on your country). Automatically allocated programme numbers may not correspond to actual or desired programme numbers. However you can sort numbers manually and clear any channels you do not wish to watch.

- 1 Press the **MENU** () button.
Result: The main menu is displayed.
- 2 Press the **▲** or **▼** button until the **Channel1** is selected.
Result: The options available in the **Channel1** group are displayed.
- 3 Press the **ENTER** () button.
Result: The **Auto Store** is selected.
- 4 Press the **ENTER** () button again.
Result: The **Auto Store** menu is displayed with **Area** option selected.
- 5 Press the **ENTER** () button once again. Select your area by pressing the **▲** or **▼** button.
Result: The areas available are listed.
- 6 Press the **ENTER** () button to confirm your choice
- 7 Press the **▲** or **▼** button until the **Search** is selected. Press the **ENTER** () button.
- 8 Press the **ENTER** () button to start the search.
Result: The search will end automatically. Channels are sorted and stored in an order which reflects their position in the frequency range, (with lowest first and highest last). The programme originally selected is then displayed.
➤ To stop the search before it has finished or return to normal viewing, press the **MENU** () button.
- 9 When the channels have been stored, you can:
 - ◆ Sort them in the order required (see page 23)
 - ◆ Clear a channel (see page 26)
 - ◆ Fine-tune channel reception if necessary (see page 28)
 - ◆ Activate/deactivate the **LNA** (Low Noise Amplifier) feature (see page 29)
 - ◆ Activate/deactivate the **Digital NR** (Digital Noise Reduction) feature (see page 37)

Sorting the Stored Channels

This operation allows you to change the programme numbers of stored channels. This operation may be necessary after using the auto store. You can delete those channels you do not want to keep.

- 1 Press the **MENU** () button.
Result: The main menu is displayed.
- 2 Press the **▲** or **▼** button until the **Channel1** is selected.
Result: The options available in the **Channel1** group are displayed.
- 3 Press the **ENTER** () button.
- 4 Press the **▲** or **▼** button until the **Sort** is selected. Press the **ENTER** () button.
Result: The **Sort** menu is displayed.
- 5 Select the channel that you wish to move by pressing the **▲** or **▼** button. Press the **ENTER** () button.
- 6 Select the number of the programme to which the channel is to be moved by pressing the **▲** or **▼** button. Press the **ENTER** () button.
Result: The channel is moved to its new position and all other channels are shifted accordingly.
- 7 Repeat Steps 5 to 6 until you have moved all the channels to the required programme numbers.

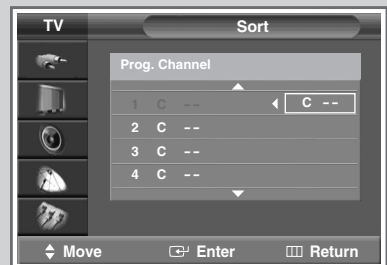
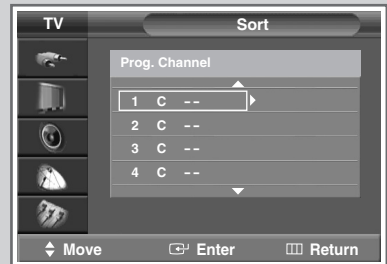

Storing Channels Manually

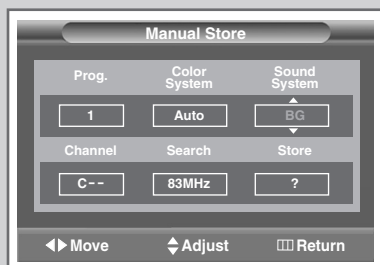
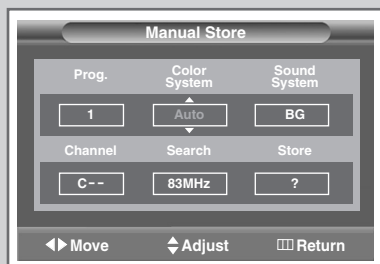
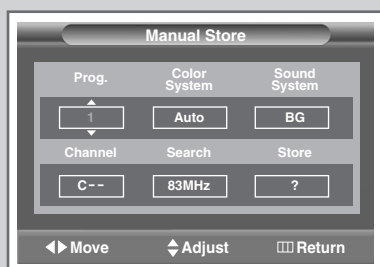

You can store the television channels, including those received via cable networks.

When storing channels manually, you can choose:

- ◆ Whether or not to store each of the channels found
- ◆ The programme number of each stored channel which you wish to identify

- 1 Press the **MENU** () button.
Result: The main menu is displayed.

- 2 Press the **▲** or **▼** button until the **Channel1** is selected.
Result: The options available in the **Channel1** group are displayed.

- 3 Press the **ENTER** () button.

- 4 Press the **▲** or **▼** button until the **Manual Store** is selected. Press the **ENTER** () button.
Result: The current channels are displayed.

- 5 Select the channel that you wish to move by pressing the **▲** or **▼** button. Press the **ENTER** () button.
Result: The **Prog.** is selected.

- 6 To assign a programme number to a channel, find the correct number by pressing the **▲** or **▼** button.

- 7 If necessary, select the broadcasting standard required. Press the **◀** or **▶** button until the **Color System** is selected and press the **▲** or **▼** button. The color standards are displayed in the following order.

Auto — PAL — SECAM — NT4.43 — NT3.58

- 8 Press the **◀** or **▶** button until the **Sound System** is selected and press the **▲** or **▼** button. The sound standards are displayed in the following order.

BG — DK — I — M

Storing Channels Manually (continued)

- 9 If you know the number of the channel to be stored, see the following steps.
- ◆ Press the ◀ or ▶ button until the **Channel1** is selected.
 - ◆ Press the ▲ or ▼ button to select **C** (Air channel) or **S** (Cable channel).
 - ◆ Press the ▶ button
 - ◆ Press the ▲ or ▼ button to select the required number.
- If no sound or abnormal sound can be heard, re-select the sound standard required.

- 10 If you do not know the channel numbers, select the **Search** by pressing the ◀ or ▶ button. To start the search, press the ▲ or ▼ button.

Result: The tuner scans the frequency range until the first channel or the channel that you selected is received on your screen.

- 11 To store the channel and associated programme number, select **Store** by pressing the ◀ or ▶ button. Set to **OK** by pressing the **ENTER** (⏏) button.

- 12 Repeat Steps 9 to 11 for each channel to be stored.

Channel mode



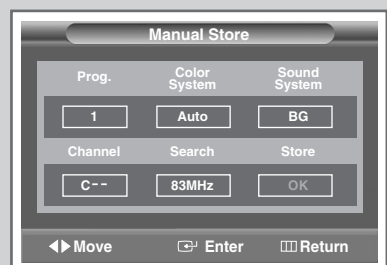
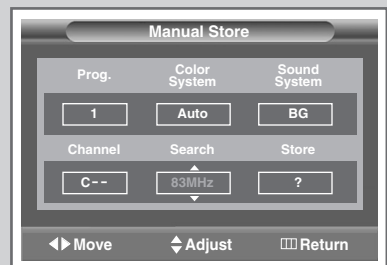
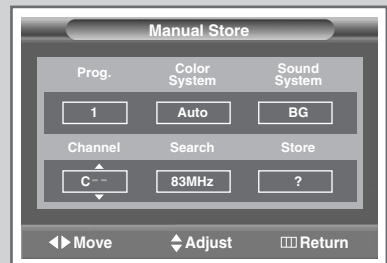
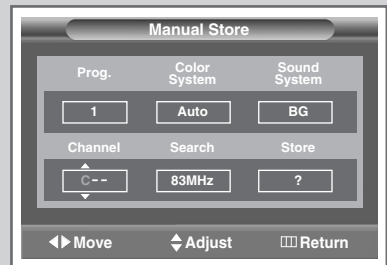

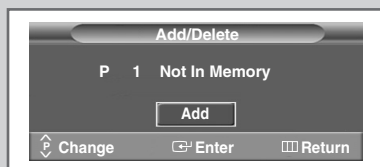
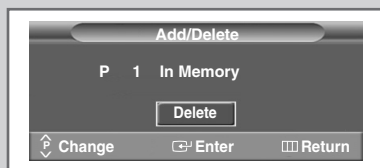

- ◆ **P** (Programme mode): When completing tuning, the broadcasting stations in your area have been assigned to position numbers from P00 to max P99. You can select a channel by entering the position number in this mode.
- ◆ **C** (Real channel mode): You can select a channel by entering the assigned number to each air broadcasting station in this mode.
- ◆ **S** (Cable channel mode): You can select a channel by entering the assigned number for each cable channel in this mode.



Skipping Unwanted Channels



You can exclude the channels of your choice from the channel scan operation. When you scan through the stored channels, those that you have chosen to skip are thus not displayed. All channels that you do not specifically choose to skip are displayed during scanning.

- 1 Press the **MENU** () button.
Result: The main menu is displayed.
- 2 Press the **▲** or **▼** button until the **Channel1** is selected.
Result: The options available in the **Channel1** group are displayed.
- 3 Press the **ENTER** () button.
- 4 Press the **▲** or **▼** button until the **Add/Delete** is selected. Press the **ENTER** () button.
Result: The **Add/Delete** menu is displayed with the current channel selected.
- 5 Press the **P**  or  button to delete or add the required channel. Press the **ENTER** () button.
- 6 Repeat Step 5 for each channel to be erased or added.

Locking the Channel

This feature allows you to lock the television so that it cannot be switched on via the front panel. It can, however, still be switched on via the remote control. Thus, by keeping the remote control away from unauthorized users, such as children, you can prevent them from watching unsuitable programme.

- 1 Press the **MENU** () button.

Result: The main menu is displayed.

- 2 Press the **▲** or **▼** button until the **Channel** is selected.



Result: The options available in the **Channel** group are displayed.

- 3 Press the **ENTER** () button.

- 4 Press the **▲** or **▼** button until the **Child Lock** is selected. Press the **ENTER** () button.

Result: The **Child Lock** menu is displayed and the current channel is shown as selected.

- 5 Press the **▲** or **▼** button to select the channel to be locked.





- 6 Press the **ENTER** () button. To lock the channel, select **Locked** by pressing the **▲** or **▼** button (to unlock the channel, select **Unlocked**). Press the **ENTER** () button to confirm.

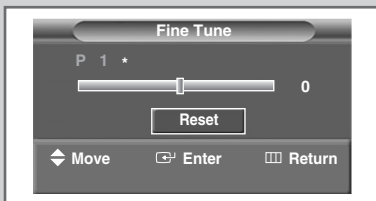
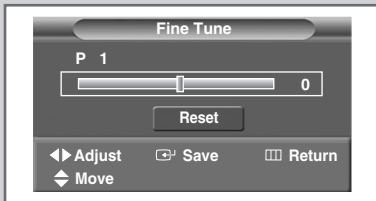

Fine Tuning Channel Reception







If the reception is clear, you do not have to fine tune the channel, as this is done automatically during the search and store operation. If the signal is weak or distorted, you may have to fine tune the channel manually.

- 1 Press the **MENU** () button.
Result: The main menu is displayed.
- 2 Press the **▲** or **▼** button until the **Channel1** is selected.
Result: The options available in the **Channel1** group are displayed.
- 3 Press the **ENTER** () button.
- 4 Press the **▲** or **▼** button until the **Fine Tune** is selected. Press the **ENTER** () button.
Result: The horizontal bar is displayed.
- 5 To obtain a sharp and clear picture and good sound quality, press the **◀** or **▶** button until you reach the setting.
- 6 To store the fine tuning setting in the TV's memory, press the **ENTER** () button.
- 7 To reset the fine tuning to **0**, select **Reset** by pressing the **▲** or **▼** button then press the **ENTER** () button.

Using the LNA (Low Noise Amplifier) Feature

This feature is very useful in the situation that the TV is used in a weak signal, and amplifies the TV signal in the weak signal area, but not noise.



This feature is working only in a weak signal condition, and that is memorized on relevant channel's additional information.

- 1 Press the **MENU** () button.
Result: The main menu is displayed.
- 2 Press the **▲** or **▼** button until the **Channel1** is selected.
Result: The options available in the **Channel1** group are displayed.
- 3 Press the **ENTER** () button.
- 4 Press the **▲** or **▼** button until the **LNA** is selected. Press the **ENTER** () button.
- 5 Select **Off** or **On** by pressing the **▲** or **▼** button. Press the **ENTER** () button to confirm.



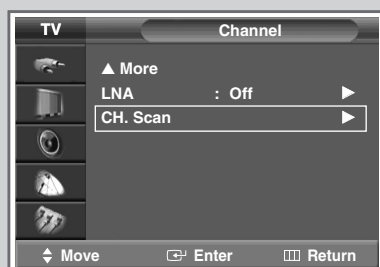



Viewing the Channel Scan Picture



- 1 Press the **MENU** () button.
Result: The main menu is displayed.
- 2 Press the **▲** or **▼** button until the **Channel1** is selected.
Result: The options available in the **Channel1** group are displayed.
- 3 Press the **ENTER** () button.
- 4 Press the **▲** or **▼** button until the **CH. Scan** is selected. Press the **ENTER** () button.
Result: You can view every memorized channel in order.

Changing the Picture Standard

You can select the picture mode which best corresponds to your viewing requirements.

- 1 Press the **MENU** () button.
Result: The main menu is displayed.
- 2 Press the **▲** or **▼** button until the **Picture** is selected.
Result: The options available in the **Picture** group are displayed.
- 3 Press the **ENTER** () button.
Result: The **Mode** is selected.
- 4 Press the **ENTER** () button again.
Result: The options available are listed.
- 5 Select the required option by pressing the **▲** or **▼** button.
Result: The following modes are available:
Dynamic – Standard – Movie – Custom
- 6 Press the **ENTER** () button to confirm.

➤ You can select these options by simply pressing the **P.MODE** ( : Picture Mode) button on the remote control.

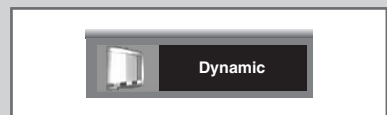
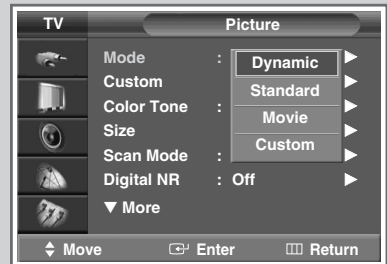
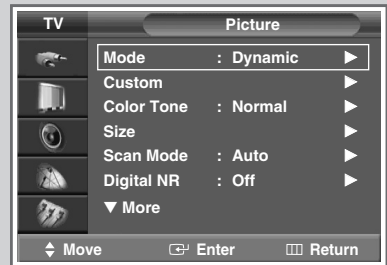

Customizing the Picture Settings

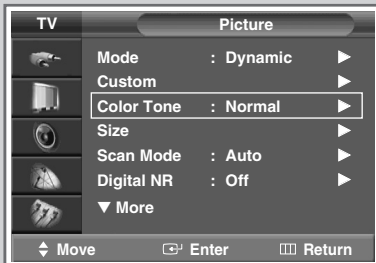
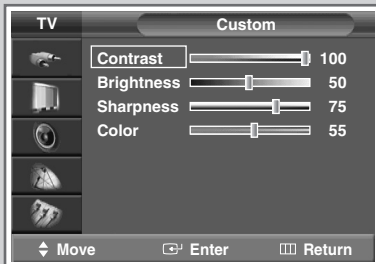
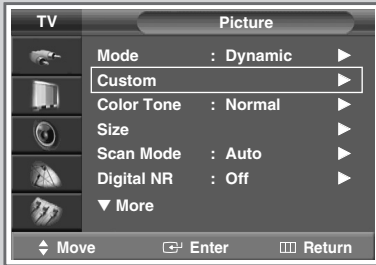



Your television has several settings options that allow you to control picture quality.

- 1 Press the **MENU** () button.
Result: The main menu is displayed.



- 2 Press the **▲** or **▼** button until the **Picture** is selected.
Result: The options available in the **Picture** group are displayed.

- 3 Press the **ENTER** () button.

- 4 Press the **▲** or **▼** button until the **Custom** is selected. Press the **ENTER** () button.
Result: The **Custom** menu is displayed.

- 5 Select the option (**Contrast**, **Brightness**, **Sharpness**, **Color** or **Tint**-NTSC only) to be adjusted by pressing the **▲** or **▼** button. Press the **ENTER** () button.
Result: The horizontal bar is displayed. Press the **◀** or **▶** button until you reach the setting.





➤ If you make any changes to the custom settings, the picture standard is automatically switched to the **Custom**.

- 6 Press the **MENU** () button to return to the **Picture** menu. Press the **▲** or **▼** button until the **Color Tone** is selected. Press the **ENTER** () button.

- 7 Select the required color tone (**Warm 1 ~ Warm 10**, **Normal**, **Cool 1 ~ Cool 10**) by pressing the **◀** or **▶** button.

Selecting the Picture Size (4:3 Model)

You can select the picture size which best corresponds to your viewing requirements.

- 1 Press the **MENU** () button.
Result: The main menu is displayed.
- 2 Press the **▲** or **▼** button until the **Picture** is selected.
Result: The options available in the **Picture** group are displayed.
- 3 Press the **ENTER** () button.
- 4 Press the **▲** or **▼** button until the **Size** is selected. Press the **ENTER** () button.
Result: The **Size** menu is displayed.
- 5 Select the required mode by pressing the **▲** or **▼** button. Press the **ENTER** () button.
Result: The following modes are available:

- Normal** Adjusts the picture to fit into a 4:3 normal aspect ratio. (Prolonged use in 4:3 mode may cause the lifespan of the CRT to be reduced.)
- Zoom 1** Vertically enlarges the picture approximately 130%.
- Zoom 2** Vertically enlarges the picture about approximately 150%.
- Cinema** When the top and bottom of the screen margin are black (blank), they will change to gray.

➤ Lifting is available in the **Zoom 1** or **Zoom 2** mode by pressing the **▲** or **▼** button

- ◆ You can select these options by simply pressing the **P.SIZE** button on the remote control.
◆ The picture size can not be changed in the PIP mode.

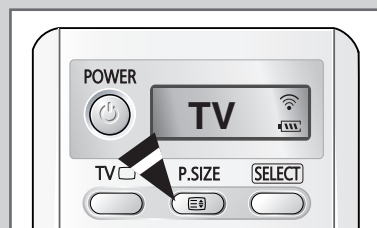
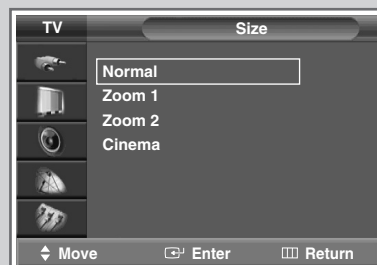
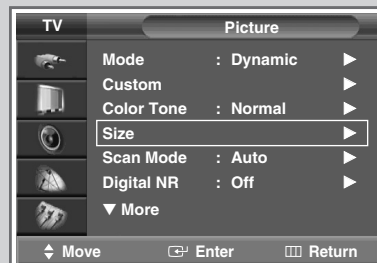

4:3 Signal

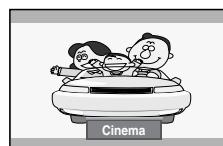
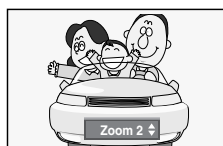
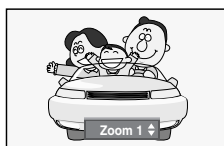
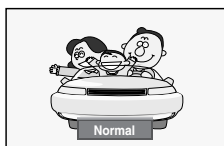



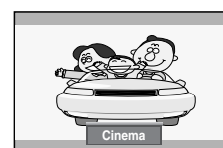
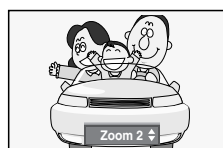
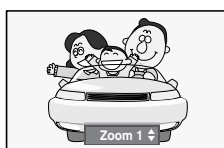
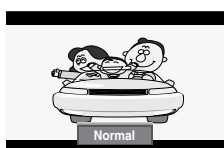

16:9 Signal

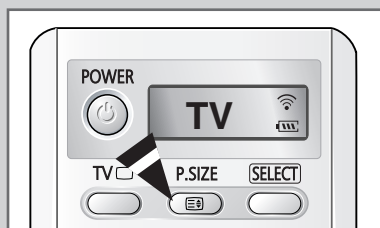
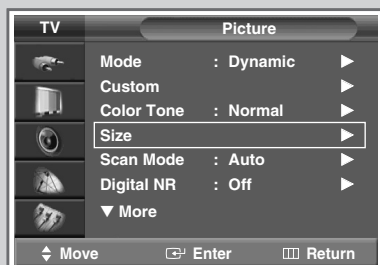

Selecting the Picture Size (Wide Model)



You can select the picture size which best corresponds to your viewing requirements.

- 1 Press the **MENU** () button.
Result: The main menu is displayed.
- 2 Press the **▲** or **▼** button until the **Picture** is selected.
Result: The options available in the **Picture** group are displayed.
- 3 Press the **ENTER** () button.
- 4 Press the **▲** or **▼** button until the **Size** is selected. Press the **ENTER** () button.
Result: The **Size** menu is displayed.
- 5 Select the required mode by pressing the **▲** or **▼** button. Press the **ENTER** () button.

Result: The following modes are available:

- | | |
|-----------------|---|
| 16:9 | Adjusts the picture to fit into the 16:9 wide aspect ratio. |
| Panorama | Adjusts a Wide picture to appear natural. |
| Zoom 1 | Vertically enlarges the picture approximately 130%. |
| Zoom 2 | Vertically enlarges the picture about approximately 150%. |
| 4:3 | Adjusts the picture to fit into a 4:3 normal aspect ratio. (Prolonged use in 4:3 mode may cause the lifespan of the CRT to be reduced.) |
| Cinema 1 | To maintain optimum screen display, the picture is vertically enlarged and the letterboxed (black margin) area is filled with gray instead. |
| Cinema 2 | When the top and bottom of the screen margin are black (blank), they will change to gray. |

- ◆ Lifting is available in the **Zoom 1** or **Zoom 2** mode by pressing the **▲** or **▼** button.
- ◆ Subtitles may be cut-off or hidden below the screen area in **Zoom 1**, **Zoom 2**, **Cinema1** and **Cinema2** modes.

- ◆ You can select these options by simply pressing the **P.SIZE** button on the remote control.
- ◆ The picture size can not be changed in the PIP mode.

Selecting the Picture Size (Wide Model) (continued)

4:3 Signal



16:9

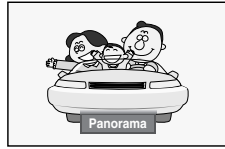

Panorama

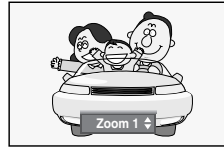

Zoom 1

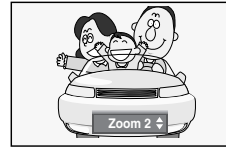

Zoom 2

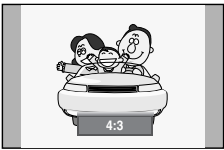

4:3

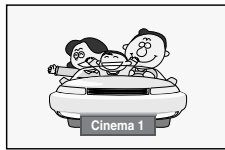

Cinema 1

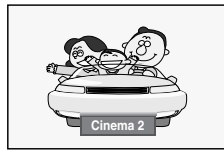

Cinema 2

16:9 Signal



16:9



Panorama

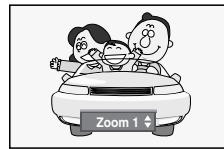

Zoom 1

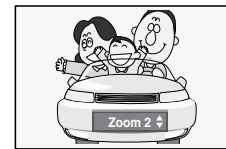

Zoom 2



4:3



Cinema 1





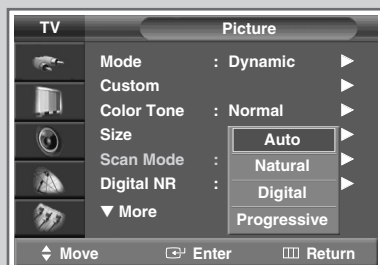
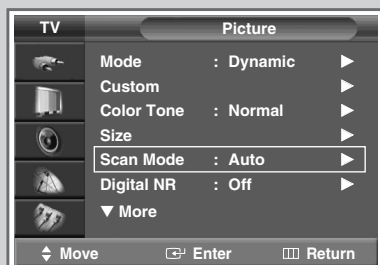

Cinema 2

Selecting the Scan Mode







*You will normally find that scan mode is best set to **Natural** to reduce any slight picture flicker. However, it is possible that some occasional broadcasts (NTSC-M) may benefit by changing the scan mode.*

- 1 Press the **MENU** () button.
Result: The main menu is displayed.
- 2 Press the **▲** or **▼** button until the **Picture** is selected.
Result: The options available in the **Picture** group are displayed.
- 3 Press the **ENTER** () button.
- 4 Press the **▲** or **▼** button until the **Scan Mode** is selected. Press the **ENTER** () button.
- 5 Select the required option by pressing the **▲** or **▼** button.
Result: The following modes are available:
Auto – Natural – Digital – Progressive
- 6 Press the **ENTER** () button to confirm.

Using the Digital NR (Digital Noise Reduction) Feature

If the signal received by your television is weak, you can activate this feature to help reduce any static and ghosting that may appear on the screen.

- 1 Press the **MENU** () button.
Result: The main menu is displayed.
- 2 Press the **▲** or **▼** button until the **Picture** is selected.
Result: The options available in the **Picture** group are displayed.
- 3 Press the **ENTER** () button.
- 4 Press the **▲** or **▼** button until the **Digital NR** is selected. Press the **ENTER** () button.
- 5 Select **Off** or **On** by pressing the **▲** or **▼** button. Press the **ENTER** () button to confirm.

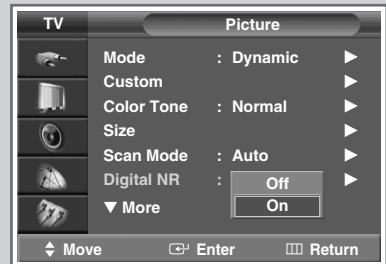
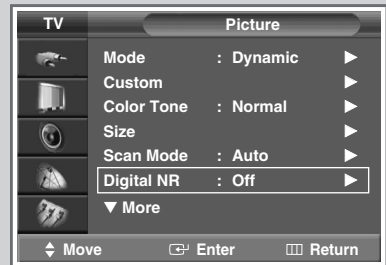

Freezing the Current Picture



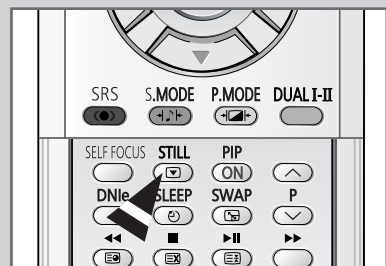

You can freeze the picture when watching a television programme simply by pressing the "STILL ()" button. To return to normal viewing, press it again.

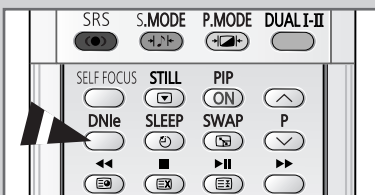
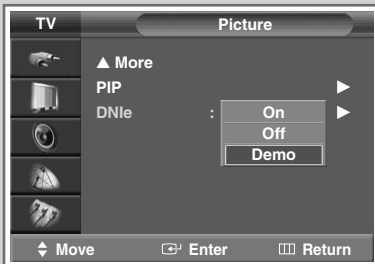
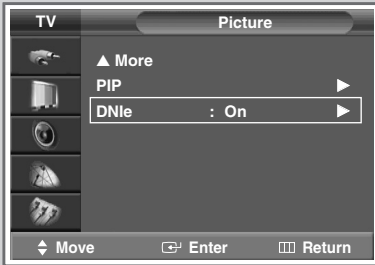

DNle™ (Digital Natural Image engine) DNle™







This feature brings you more detailed image with 3D noise reduction, detail enhancement, contrast enhancement and white enhancement. New image compensation Algorithm presents brighter, clearer, much detailed image. DNle™ technology will fit every signals into your eyes.

- 1 Press the **MENU** () button.
Result: The main menu is displayed.
- 2 Press the **▲** or **▼** button until the **Picture** is selected.
Result: The options available in the **Picture** group are displayed.
- 3 Press the **ENTER** () button.
- 4 Press the **▲** or **▼** button until the **DNle** is selected. Press the **ENTER** () button.
- 5 Press the **▲** or **▼** button to change the setting. Press the **ENTER** () button to confirm.
 - ◆ **On:** Switches on the DNle mode.
 - ◆ **Off:** Switches off the DNle mode.
 - ◆ **Demo (Option) :** The screen before applying DNle appears on the right and the screen after applying DNle appears on the left.

➤ You can select these options simply by pressing the **DNle** button.

Setting the Blue Screen Mode

*If no signal is being received or the signal is very weak, a blue screen automatically replaces the noisy picture background. If you wish to continue viewing the poor picture, you must set the **Blue Screen mode to Off**.*

- 1 Press the **MENU** () button.
Result: The main menu is displayed.
- 2 Press the **▲** or **▼** button until the **Setup** is selected.
Result: The options available in the **Setup** group are displayed.
- 3 Press the **ENTER** () button.
- 4 Press the **▲** or **▼** button until the **Blue Screen** is selected. Press the **ENTER** () button.
- 5 Select **Off** or **On** by pressing the **▲** or **▼** button. Press the **ENTER** () button to confirm.



Viewing the Picture In Picture (PIP)

You can display a sub picture within the main picture of TV program or external A/V devices. In this way you can watch TV program or monitor the video input from any connected devices while watching TV or other video input.

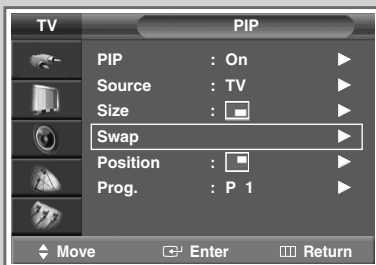
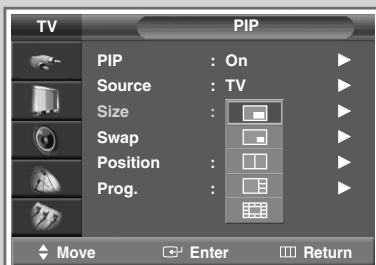
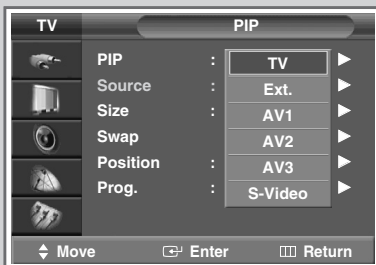
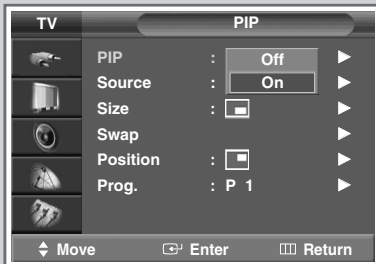
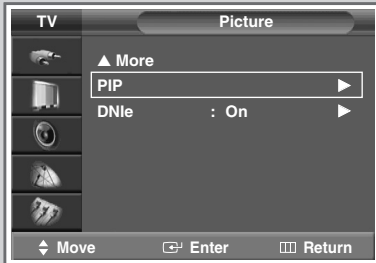



- 1 Press the **MENU** () button.
Result: The main menu is displayed.

- 2 Press the **▲** or **▼** button until the **Picture** is selected.
Result: The options available in the **Picture** group are displayed.



- 3 Press the **ENTER** () button.

- 4 Press the **▲** or **▼** button until the **PIP** is selected. Press the **ENTER** () button.
Result: The **PIP** menu is displayed with **PIP** option selected.

- 5 Press the **ENTER** () button again. To activate, set the **PIP** to **on** by pressing the **▲** or **▼** button. Press the **ENTER** () button.

- 6 Press the **▲** or **▼** button until the **Source** is selected. Press the **ENTER** () button.
Result: The sources available are displayed.
TV — Ext. — AV1 — AV2 — AV3 — S-Video

- 7 Select a source of the sub picture by pressing the **▲** or **▼** button. Press the **ENTER** () button

- 8 Press the **▲** or **▼** button until the **Size** is selected. Press the **ENTER** () button.
Result: The sizes available are displayed.

(Large) (Small) (Double) (3-PIP) (12-PIP)
➤ ◆ 12-PIP : You can view up to 12 memorized channels on the sub picture spontaneously.
◆ On the 12 -PIP or 3-PIP mode, it is impossible to execute swap and position.

- 9 Select a size of the sub picture by pressing the **▲** or **▼** button. Press the **ENTER** () button.

- 10 Press the **▲** or **▼** button until the **Swap** is selected. Press the **ENTER** () button.
Result: The main picture and the sub picture are interchanged.
➤ Not available in 12-PIP or 3-PIP modes.

Viewing the Picture In Picture (PIP) (continued)

- 11 Press the ▲ or ▼ button until the **Position** is selected. Press the **ENTER** () button.

Result: The positions available are displayed.



- The **Position** menu is available when the **Size** is Large or Small.

- 12 Select a position of the sub picture by pressing the ▲ or ▼ button. Press the **ENTER** () button.

- 13 Press the ▲ or ▼ button until the **Prog.** is selected. Press the **ENTER** () button. You can select the channel that you want to view through sub picture by pressing the ▲ or ▼ button.

- When the **Source** is set to **TV**, you can select the channel of sub picture.

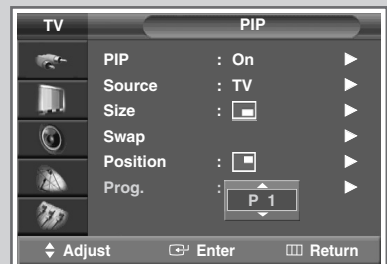
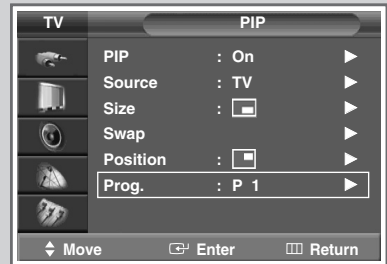
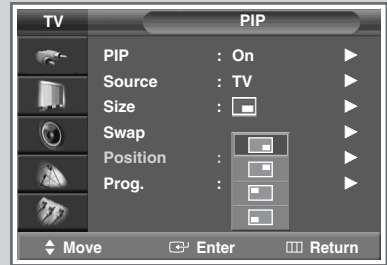

Easy functions of remote control.

Buttons	Feature
PIP	Used to activate or deactivate the PIP function directly.
SWAP	Used to interchange the main picture and the sub picture. ➤ When the main picture is in the Video mode and the sub picture is in the TV mode, you might not hear the sound of main picture when pressing the SWAP () button after changing the sub picture channel. At this time, reselect the channel of main picture.



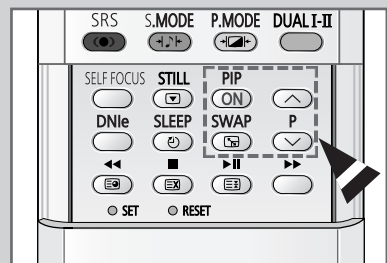

P ^ / \ ▼ Used to select the channel of sub picture.

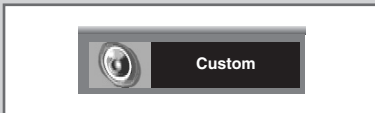
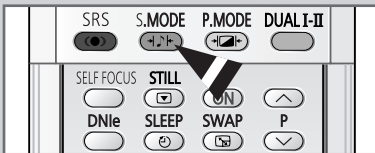
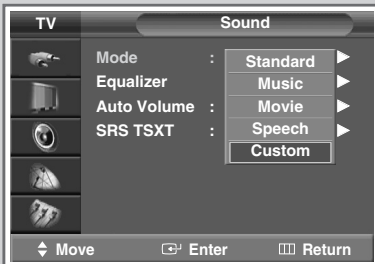
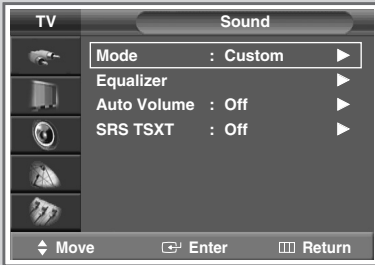

Changing the Sound Standard





You can select the type of special sound effect to be used when watching a given broadcast.

- 1 Press the **MENU** () button.
Result: The main menu is displayed.
- 2 Press the **▲** or **▼** button until the **Sound** is selected.
Result: The options available in the **Sound** group are displayed.
- 3 Press the **ENTER** () button.
Result: The **Mode** is selected.
- 4 Press the **ENTER** () button again.
- 5 Select the required option by pressing the **▲** or **▼** button.
Result: The following modes are available:
Standard - Music - Movie - Speech - Custom.
- 6 Press the **ENTER** () button to confirm.

➤ You can select these options simply by pressing the **S.MODE** () : Sound Mode) button.

Adjusting the Sound Settings

The sound settings can be adjusted to suit your personal preferences.

- 1 Press the **MENU** () button.
Result: The main menu is displayed.
- 2 Press the **▲** or **▼** button until the **Sound** is selected.
Result: The options available in the **Sound** group are displayed.
- 3 Press the **ENTER** () button.
- 4 Press the **▲** or **▼** button until the **Equalizer** is selected. Press the **ENTER** () button.
Result: The **Equalizer** menu is displayed with the current option.
- 5 Select the option to be adjusted by pressing the **◀** or **▶** button. Press the **▲** or **▼** button until you reach the setting.



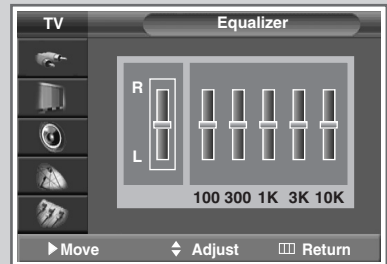
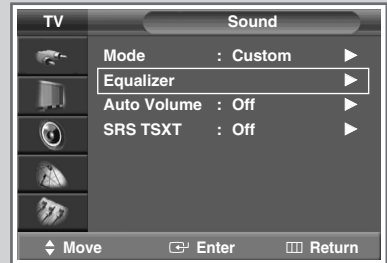

➤ If you make any changes to the equalizer settings, the sound standard is automatically switched to the **Custom**.

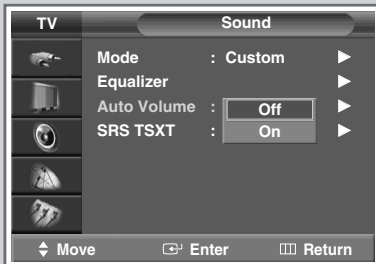
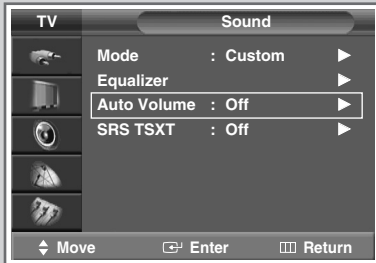

Adjusting the Volume Automatically



Each broadcasting station has its own signal conditions, and so it is not easy for you to adjust the volume every time the channel is changed. This feature lets you automatically adjust the volume of the desired channel by lowering the sound output when the modulation signal is high or by raising the sound output when the modulation signal is low.

- 1 Press the **MENU** () button.
Result: The main menu is displayed.
- 2 Press the **▲** or **▼** button until the **Sound** is selected.
Result: The options available in the **Sound** group are displayed.
- 3 Press the **ENTER** () button.
- 4 Press the **▲** or **▼** button until the **Auto Volume** is selected. Press the **ENTER** () button.
- 5 Select **Off** or **On** by pressing the **▲** or **▼** button. Press the **ENTER** () button to confirm.

Setting the TruSurround XT

TruSurround XT is a patented SRS technology that solves the problem of playing 5.1 multichannel content over two speakers. TruSurround delivers a compelling, virtual surround sound experience through any two-speaker playback system, including internal television speakers. It is fully compatible with all multichannel formats.

- 1 Press the **MENU** () button.
Result: The main menu is displayed.

- 2 Press the **▲** or **▼** button until the **Sound** is selected.
Result: The options available in the **Sound** group are displayed.

- 3 Press the **ENTER** () button.

- 4 Press the **▲** or **▼** button until the **SRS TSXT** is selected. Press the **ENTER** () button.

- 5 Select the required option (**Off**, **3D Mono** or **Stereo**) by pressing the **▲** or **▼** button.

- 6 Press the **ENTER** () button to confirm.

- ◆ TruSurround XT, SRS and Symbol () are trademarks of SRS Labs, Inc. TruSurround XT technology is incorporated under license from SRS Labs, Inc.





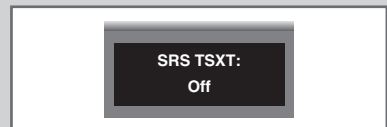
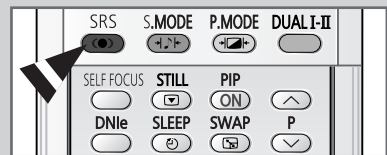
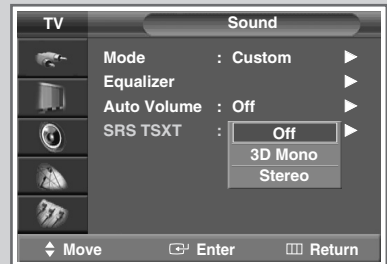
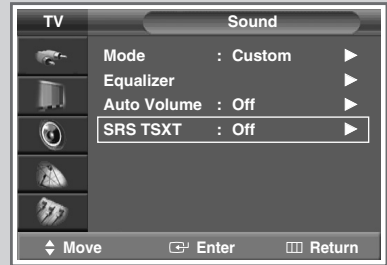

- ◆ You can select these options simply by pressing the **SRS** () button.



Setting the Melody Sound



You can hear clear melody sound when the television is powered on or off.

- 1 Press the **MENU** () button.
Result: The main menu is displayed.
- 2 Press the **▲** or **▼** button until the **Setup** is selected.
Result: The options available in the **Setup** group are displayed.
- 3 Press the **ENTER** () button.
- 4 Press the **▲** or **▼** button until the **Melody** is selected. Press the **ENTER** () button.
- 5 Select the required option (**Off** or **On**) by pressing the **▲** or **▼** button.
- 6 Press the **ENTER** () button to confirm.

Selecting the Sound Mode (depending on the model)

The “DUAL I-II” button displays/controls the processing and output of the audio signal. When power is switched on, the mode is automatically preset to either “Dual I” or “Stereo”, depending on the current transmission.

	Type of broadcast	On-screen indication
NICAM Stereo	Regular broadcast (Standard audio)	Mono (Normal use)
	Regular + NICAM Mono	NICAM Mono ↔ Mono (Normal)
	NICAM Stereo	NICAM Stereo ↔ Mono (Normal)
	NICAM Dual I/II	NICAM Dual I → NICAM Dual II → Mono (Normal) ↑—————↓
A2 Stereo	Regular broadcast (Standard audio)	Mono (Normal use)
	Bilingual or Dual I/II	Dual I ↔ Dual II
	Stereo	Stereo ↔ Mono (Forced mono)

- ◆ If the receiving conditions deteriorate, listening will be easier if the mode is set to the **Mono**.
- ◆ If the stereo signal is weak and an automatic switching occurs, then switch to the **Mono**.
- ◆ When receiving a mono sound in the AV mode, connect to the “AUDIO-L” input connector on the panel (front or side). If the mono sound comes out only from left speaker, press the **DUAL I-II** button.

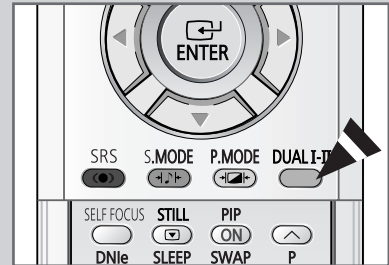

Setting and Displaying the Current Time

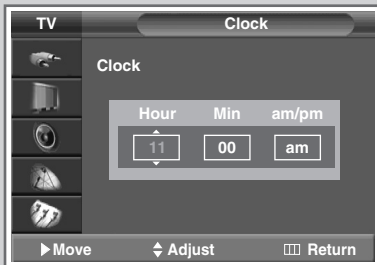

You can set the television's clock so that the current time is displayed by pressing the "INFO ()" button. You must also set the time if you wish to use the automatic on or off timers.

➤ When pressing the "I" button (On/Off) on the panel of the television, the clock setting will be reset.

1 Press the **MENU** () button.

Result: The main menu is displayed.

2 Press the **▲** or **▼** button until the **Setup** is selected.

Result: The options available in the **Setup** group are displayed.

3 Press the **ENTER** () button.

4 Press the **▲** or **▼** button until the **Time** is selected. Press the **ENTER** () button.

Result: The options available in the **Time** group are displayed with **Clock** is selected.

5 Press the **ENTER** () button.

6 Press the **◀** or **▶** button to move to the **Hour**, **Min** or **am/pm**. Set these by pressing the **▲** or **▼** button.

➤ You can also set the **Hour** and **Min** by pressing the numeric buttons directly

Setting the Sleep Timer

You can select a time period of between 30 and 180 minutes after which the television automatically switches to Standby mode.

- 1 Press the **MENU** () button.
Result: The main menu is displayed.

- 2 Press the **▲** or **▼** button until the **Setup** is selected.
Result: The options available in the **Setup** group are displayed.

- 3 Press the **ENTER** () button.

- 4 Press the **▲** or **▼** button until the **Time** is selected. Press the **ENTER** () button.
Result: The options available in the **Time** group are displayed.

- 5 Press the **▲** or **▼** button until the **Sleep Timer** is selected. Press the **ENTER** () button.

- 6 Select the preset time interval (**Off**, **30**, **60**, **90**, **120**, **150**, **180**) for staying on by pressing the **▲** or **▼** button. Press the **ENTER** () button to confirm.

- ◆ You can also set these options simply by pressing the **SLEEP** () button.
- ◆ If the sleep timer is not yet set, **off** is displayed. If the sleep timer is already set, the remaining time before which the television switches to Standby mode is displayed.

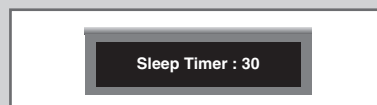
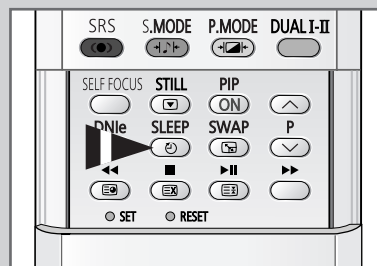
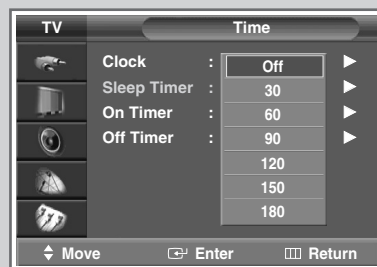



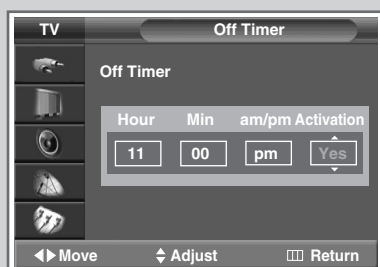
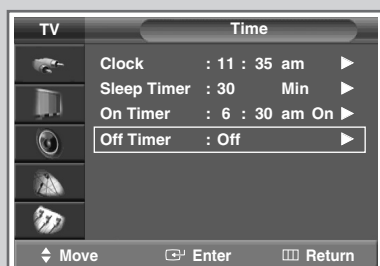
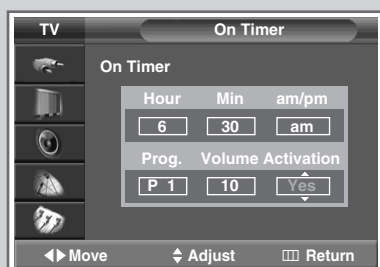
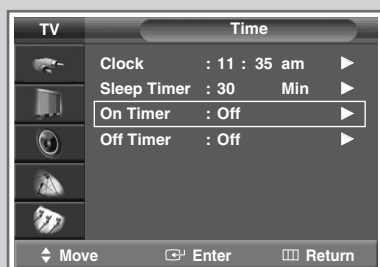



Switching the Television On and Off Automatically



You can set the On or Off timers so that the television will:

- ◆ Switch on automatically and tune to the channel of your choice at the time you select
- ◆ Switch off automatically at the time you select

➤ The first step is to set the television's clock (refer to "Setting the Current Time" on page 48). If you have not yet set the clock, the message **Set the clock first.** is displayed.

- 1 Press the **MENU** () button.
Result: The main menu is displayed.
- 2 Press the **▲** or **▼** button until the **Setup** is selected.
Result: The options available in the **Setup** group are displayed.
- 3 Press the **ENTER** () button.
- 4 Press the **▲** or **▼** button until the **Time** is selected. Press the **ENTER** () button.
Result: The options available in the **Time** group are displayed.
- 5 Press the **▲** or **▼** button until the **On Timer** is selected. Press the **ENTER** () button.
Result: The options available in the **On Timer** group are displayed.
- 6 Select the **Hour**, **Min**, **am/pm**, **Prog.** (programme number), or **Volume**. Press the **◀** or **▶** button to set these by pressing the **▲** or **▼** button.
- 7 To activate **On Timer** with the settings satisfied, select **Activation** to by pressing the **◀** or **▶** button, then select **Yes** by pressing the **▲** or **▼** button.
- 8 Press the **MENU** () button.
Result: The options available in the **Time** group are displayed again.
- 9 Press the **▲** or **▼** button until the **Off Timer** is selected. Press the **ENTER** () button.
Result: The **Off Timer** menu is displayed.
- 10 Set the **Off Timer** as methods for **On Timer** setting.

➤ Absent Power Off

When you set the timer "On", your television will eventually be turned off, if you do not operate any controls during the 3 hours after the TV is turned on by timer. This function is available in only the timer "On" mode and will prevent a leakage accident or overheating, caused by your TV left on for a long time due to the timer "On" (when you are away on holiday, for example).

Viewing an External Signal Source

Use the remote control to switch between viewing signals from connected equipment, such as VCR, DVD, Set-Top Box and the TV source (broadcast or cable)

- 1 Press the **MENU** () button.

Result: The options available in the **Input** group are displayed.

- 2 Press the **ENTER** () button.

Result: The **Source List** is selected.

- 3 Press the **ENTER** () button again.

- 4 Press the **▲** or **▼** button to select signal source, then press the **ENTER** () button.

➤ ◆ When you connect equipment to the TV, you can choose between the following sets of jacks : **Ext.**, **AV1**, **AV2**, **Component1** or **Component2** on the TV's rear panel, and **AV3** or **S-Video** on the TV's side panel.

- ◆ You can select these options simply by pressing the **SOURCE** () button.

- 5 Press the **MENU** () button.

Result: The options available in the **Input** group are displayed again.

- 6 Press the **▲** or **▼** button until the **Edit Name** is selected. Press the **ENTER** () button.

- 7 Press the **▲** or **▼** button to select the external source to be edited. Press the **ENTER** () button.

Result: The device names available are listed.

**VCR - DVD - Cable STB - HD STB -
Satellite STB - AV Receiver - DVD Receiver -
Game - Camcorder - DVD Combo -
DHR (DVD HDD Recorder) - PC.**

- 8 Select the required device by pressing the **▲** or **▼** button. Press the **ENTER** () button to confirm.

➤ If you change the external source while viewing, pictures might take a short period of time to be switched.

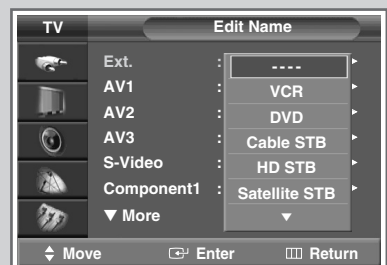
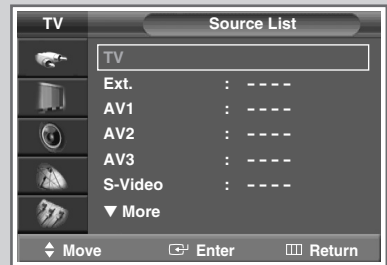

Teletext Feature

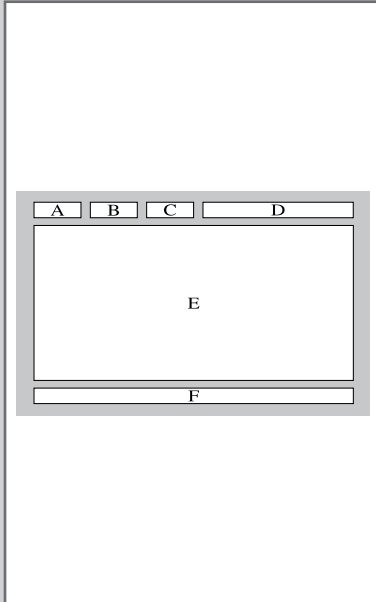

Most television channels provide written information services via teletext. Information provided includes:

- ◆ *Television programme times*
- ◆ *News bulletins and weather forecasts*
- ◆ *Sports results*
- ◆ *Travel information*

This information is divided into numbered pages (see diagram).

Part	Contents
A	Selected page number.
B	Broadcasting channel identity.
C	Current page number or search indications.
D	Date and time.
E	Text.
F	Status information. FASTEXT information.





- Teletext information is often divided between several pages displayed in sequence, which can be accessed by:
- ◆ Entering the page number
 - ◆ Selecting a title in a list
 - ◆ Selecting a colored heading (FASTEXT system)

Displaying the Teletext Information

You can display Teletext information at any time on your television.

For Teletext information to be displayed correctly, channel reception must be stable; otherwise:

- ◆ Information may be missing
- ◆ Some pages may not be displayed

- 1 Select the channel providing the Teletext service using the **P** or **CH** button.
- 2 Press the **TTX/MIX** () button to activate the teletext mode.
Result: The contents page is displayed. It can be redisplayed at any time by pressing the **INDEX** () button.
- 3 Press the **TTX/MIX** () button again.
Result: The screen will be split into two. This Double Teletext feature lets you view the actual broadcast and teletext information separately on the screen.
- 4 If you wish to display the actual broadcast at the same time as the teletext page, press the **TTX/MIX** () button again.
- 5 Press the **TV** () button again to exit from the teletext display.

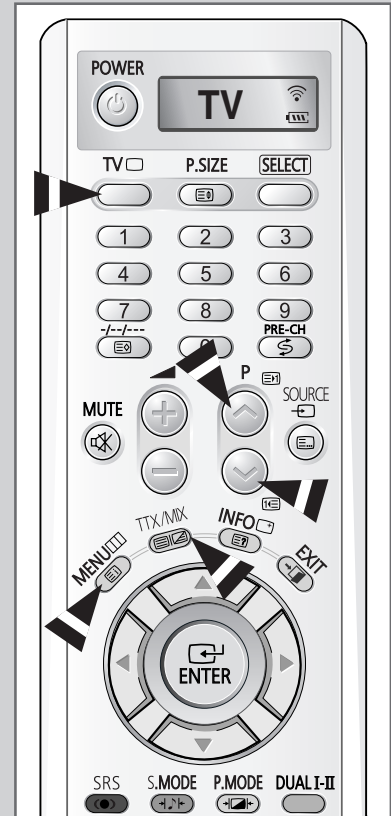

Selecting Display Options

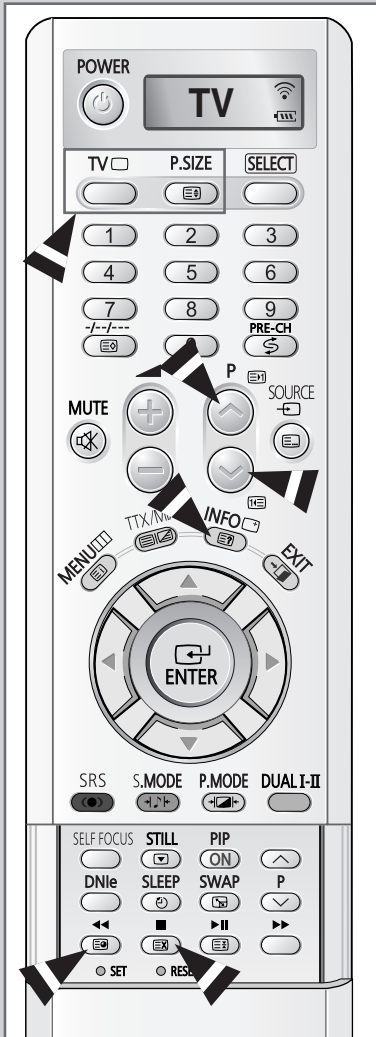





When you have displayed a Teletext page, you can select various options to suit your requirements.

To display...	Press the...
◆ Hidden text (answers to quiz games, for example)	[?] (reveal)
◆ The normal screen	[?] (reveal) again
◆ A secondary page	[◂] (sub-page)
◆ The broadcast when searching for a page	[X] (cancel)
◆ The next page	[▶] (page up)
◆ The previous page	[◂] (page down)
◆ Double-size letters in the: <ul style="list-style-type: none"> • Upper half of the screen • Lower half of the screen 	[S] (size) <ul style="list-style-type: none"> • Once • Twice
◆ Normal screen	• Three times

➤ To return to the normal display after using the reveal or size feature, press the **TV** (□) button.

Selecting a Teletext Page

You can enter the page number directly by pressing the numeric buttons on the remote control.

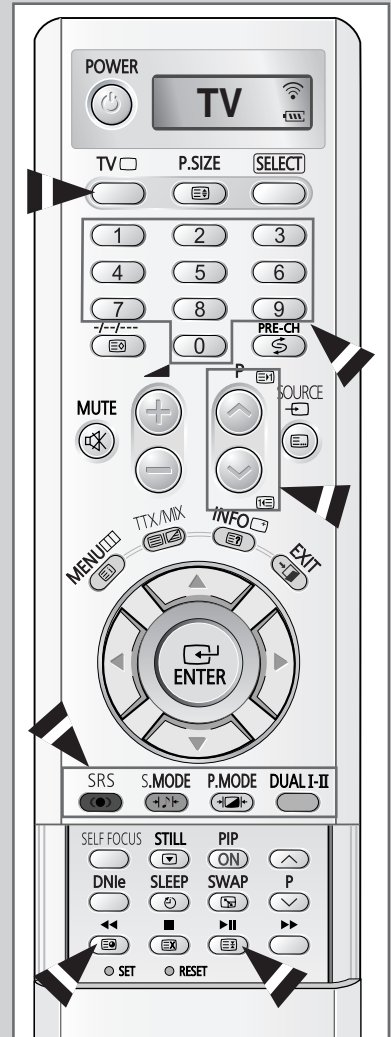

- 1 Enter the three-digit page number given in the content by pressing the corresponding numeric buttons.
Result: The current page counter is incremented and the page is then displayed. If the selected page is linked with several secondary pages, the secondary pages are displayed in sequence. To freeze the display on a given page, press the  (hold). Press it again to resume.
- 2 If the FASTEXT system is used by the broadcasting company, the different topics covered on a Teletext page are color-coded and can be selected by pressing the colored buttons on the remote control. Press the colored button corresponding to the topic that you wish to select; the available topics are given on the status line.
Result: The page is displayed with other colored information that can be selected in the same way.
- 3 To display the previous or next page, press the corresponding colored button.
- 4 To display the subpage, see the following steps.
 - ◆ Press the  (sub-page) button.
Result: The available subpages appear.
 - ◆ Select the required sub-page. Sub-pages can be scrolled by pressing the  or  button.
- 5 When you have finished, press the TV () button to return to your normal broadcast.

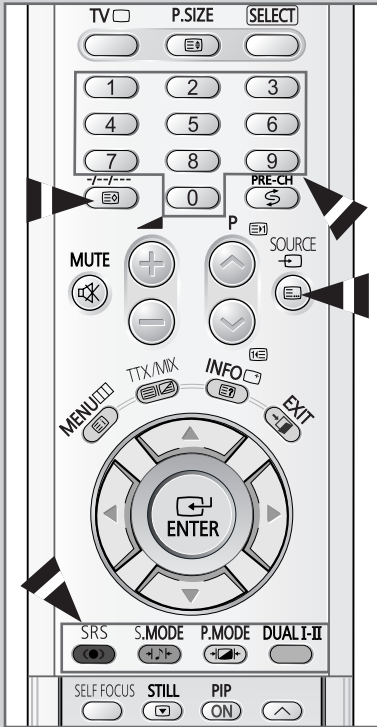

Storing Teletext Pages (depending on the model)



You can store up to four teletext pages to display them later at leisure.

- 1 Select the LIST mode using the  button.
Result: Four 3-digit numbers are displayed in different colors.
➤ The  button is used to switch between the LIST and FLOF modes.
- 2 Press the colored button corresponding to the page that will be replaced.
- 3 Enter the new page number using the numeric buttons.
- 4 Repeat steps **2** and **3** for each page to be stored, using a different colored button each time.
- 5 Press the  (store) button until the corresponding blocks blink.

Connecting to the External Devices

Rear of the TV

(Input/Output)

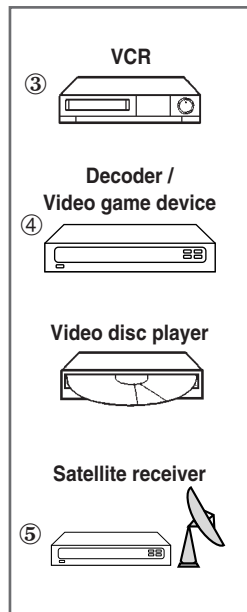
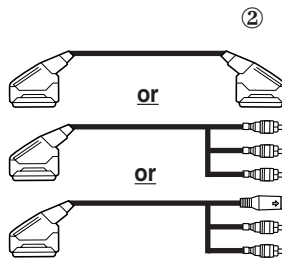
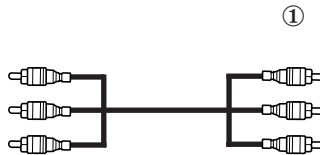
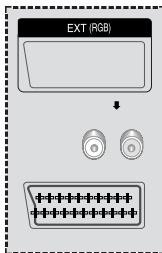
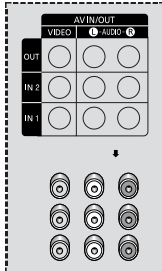

- ① This end can be fitted with:
 - ◆ Three RCA connectors (**VIDEO + AUDIO-L and R**)
- ② This end can be fitted with:
 - ◆ A SCART connector
 - ◆ Three RCA connectors (**VIDEO + AUDIO-L and R**)
 - ◆ An S-Video connector and two audio RCA connectors (L+R)
- ③ If you have a second VCR and wish to copy cassettes tape, connect the source VCR to **IN 1** (or **IN 2**) and the target VCR to **OUT** so that you can redirect the signal from source VCR to target VCR.
- ④ If you have a decoder, connect the decoder to the VCR and the VCR to the television.
- ⑤ When you wish to record a programme, connect the receiver to **IN 1** (or **IN 2**) and the VCR to **OUT** so that you can redirect the signal from **IN 1** (or **IN 2**) to **OUT**.
- ⑥ **OUT** is used for displaying the current picture to an external device. When you wish to record the current picture, connect the VCR to **OUT**.

Side of the TV

(depending on the model)

(Input)

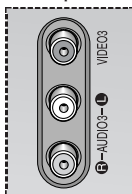

Front of the TV

(Input)

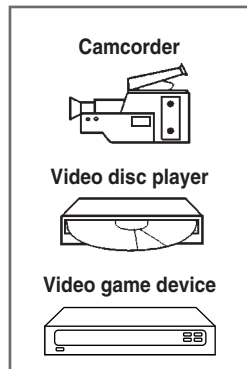
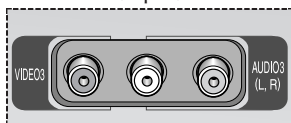

Connecting to the Audio Output

- The **AUDIO OUT** RCA connectors are used for equipment, such as an audio system (to take full advantage of the Surround sound effect).

Rear of the TV

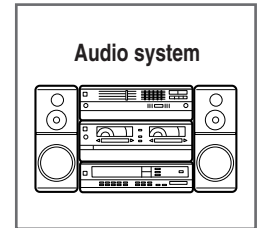
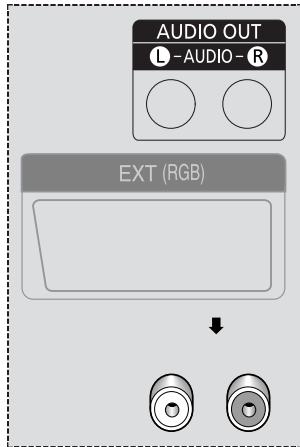

Connecting to the S-Video Input

- The **S-VIDEO INPUT** and RCA (**AUDIO3-L** and **R**) connectors are used for equipment with an S-Video output, such as a camcorder or VCR.

Side of the TV

(depending on the model)

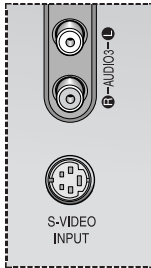

Front of the TV

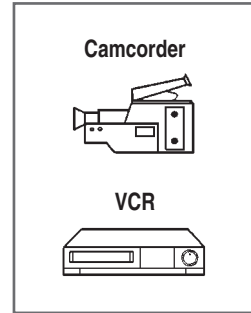
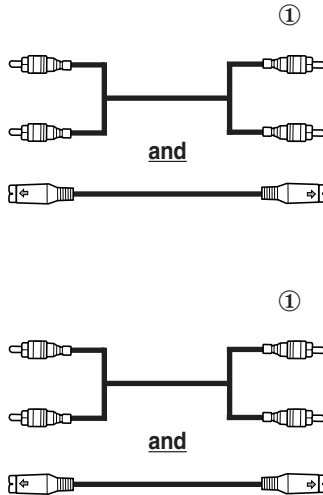

- ① To play pictures and sound, both the **S-VIDEO INPUT** and RCA connectors must be used.

Connecting to the Component Input

Rear of the TV

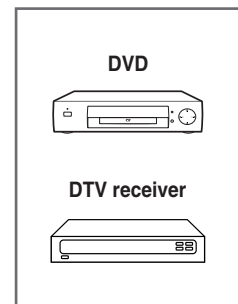
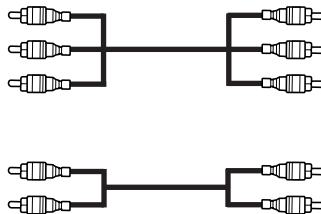
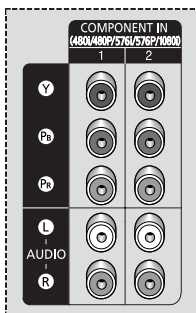

- The **COMPONENT IN** connectors are used for equipment with a DVD or DTV receiver output. (480i, 480p, 576i, 576p, 1080i)

Programming the Remote Control for Other Components

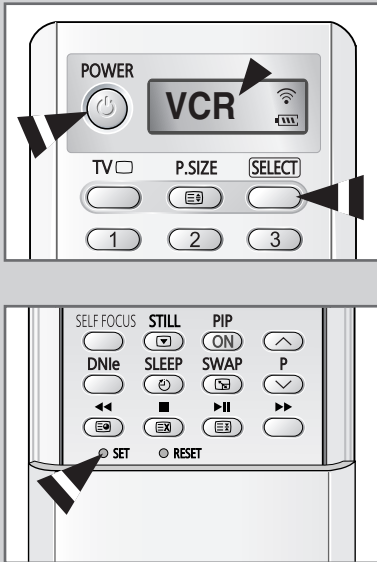

Your TV comes equipped with a universal remote control. In addition to controlling the TV, the universal remote control can also operate a VCR, Cable box, DVD and Set-Top Box made by Samsung (even if your VCR, Cable box and DVD are made by manufacturers other than Samsung).

➤ *The remote control might not be compatible with all VCRs, DVD players and Cable boxes.*

- 1 Turn off your VCR (Cable box or DVD).
- 2 Press the **SELECT** button to switch the remote control to the **VCR (CATV or DVD)** mode.
 - The remote control has five modes : **TV, VCR, CATV, DVD** and **STB**)
- 3 Press the **SET** button.
- 4 Enter 3 digits of the VCR (Cable box or DVD) code listed on next page for your VCR (Cable box or DVD).

Example: To enter the code "6", press 0, 0, and 6.
To enter the code "76", press 0, 7, and 6.
- 5 Press the **POWER** (⏻) button. Your VCR (Cable box or DVD) should turn on. If it turns on, your remote control is now set correctly.
 - If it does not turn on, repeat steps above, but try one of the other codes listed for the brand of particular yours.
- 6 Once your remote control is set up, press the **SELECT** button any time you want to use the remote control to operate VCR (Cable box or DVD).
 - ◆ When your remote control is in the **VCR, CATV, DVD** or **STB** mode, the volume buttons still control your television's volume.
 - ◆ When your remote control is in the **TV** mode, the VCR or DVD control buttons (rewind, stop, play/pause and fast forward) still operate your VCR or DVD.

Programming the Remote Control for Other Components

VCR Remote Control Codes

Admiral	020	Marantz	007, 008, 018, 021, 026, 036, 037, 062
Aiwa	025	Marta	006
Akai	004, 027, 032	MEI	021
Audio Dynamics	007, 026	Memorex	006, 021, 024, 025
Bell&Howell	018	MGA	034
Broksonic	022	Midland	005
Candle	002, 003, 006, 008, 015, 055	Minolta	019, 041
Canon	021, 056	Mitsubishi	019, 034, 041, 046
Citizen	002, 003, 006, 008, 015, 055	Montgomery Ward	020
Colortyme	007	MTC	002, 025
Craig	002, 024	Multitech	002, 005, 025, 038
Curtis Mathes	002, 007, 008, 017, 021, 025, 056, 064, 066	NEC	007, 008, 018, 026, 037, 062, 064
		Optimus	020
Daewoo	003, 010, 011, 012, 013, 014, 015, 016	Panasonic	021, 056, 071, 072
DBX	007, 026	Pentax	019, 041
Dimensia	017	Pentex Research	008
Dynatech	034	Philco	021, 036, 056, 059
Emerson	001, 003, 006, 021, 022, 025, 030, 032, 034, 040, 047, 050, 052, 060, 063, 065, 066, 067, 069	Philips	021, 036
		Pioneer	019, 026, 039, 053
		Portland	015, 049, 055
Fisher	018, 024, 028, 029, 048, 051, 061	PROSCAN	017
Funai	025	Quartz	018
General Electric	002, 005, 017, 021, 056	Quasar	021, 056
Go Video	002	Radio Shack/Realistic	006, 018, 020, 021, 024, 025, 029, 034, 048, 056
LG (Goldstar)	006, 007, 008, 009, 010	RCA	002, 017, 019, 021, 035, 041, 043, 057, 068
Harman Kardon	007	Samsung	000, 001, 002, 003, 004, 005
Hitachi	019, 025, 041, 042	Sansui	026
Instant Replay	021	Sanyo	018, 024
JC Penny	002, 007, 018, 019, 021, 026, 037, 041, 054, 056	Scott	003, 047, 052, 067
JVC	007, 008, 018, 021, 026, 037	Sears	006, 018, 019, 024, 028, 029, 041, 048, 051
Kenwood	007, 008, 018, 026, 037	Sharp	020, 034, 045, 015
KLH	070	Shimom	027, 033, 038, 058
Liloyd	025	Signature	025
Logik	038	Sony	027, 033, 044
LXI	025		
Magnavox	021, 036, 056, 059		

Programming the Remote Control for Other Components

VCR Remote Control Codes (continued)

Sylvania	021, 025, 036, 056, 059	Totevision	002, 006
Symphonic	025	Unitech	002
Tandy	018, 025	Vector Research	007, 026
Tashika	006	Victor	026
Tatung	037	Video Concepts	007, 026
Teac	025, 037, 068	Videosonic	002
Technics	021	Wards	002, 003, 006, 019, 020, 021, 024, 025, 034, 038, 041
Teknika	006, 021, 025, 031	Yamaha	007, 008, 018, 026, 037
TMK	066	Zenith	023, 027, 033, 073
Toshiba	003, 019, 029, 051, 052		

Cable Box (CATV) Remote Control Codes

Anvision	017, 018	Regency	015, 023
GI	041	SA	042, 043
Hamlin	003, 024, 031	Samsung	000, 001, 002, 003, 004, 005, 006, 007
Hitachi	025, 030	Scientific Atlanta	042, 043
Jerrold	038, 039	Sprucer	022
Macom	025, 030	Stargate 2000	036
Magnavox	019, 023, 028	Sylvania	016
Oak	026	Texscan	016
Panasonic	003, 022, 027, 037, 044	Tocom	032
Philips	019, 021, 023, 028	Universal	033, 034
Pioneer	004, 018, 020, 044	Viewstar	019, 021, 023, 028
RCA	014, 022, 040	Wamer amex	046
Regal	003	Zenith	017, 029, 035, 037, 045

DVD Remote Control Codes

Samsung	000, 001	LG (Goldstar)	006
JVC	002	Sony	007
PROSCAN/RCA	003	Denon	008
Panasonic	005	Curtis Mathes	009

Troubleshooting: Before Contacting Service Personnel

Before contacting Samsung after-sales service, perform the following simple checks.

If you cannot solve the problem using the instructions below, note the model and serial number of the television and contact your local dealer.

No sound or picture	<ul style="list-style-type: none">◆ Check that the mains lead has been connected to a wall socket.◆ Check that you have pressed the "I" button (On/Off) and the POWER (⏻) button.◆ Check the picture contrast and brightness settings.◆ Check the volume.
Normal picture but no sound	<ul style="list-style-type: none">◆ Check the volume.◆ Check whether the volume MUTE (🔇) button on the remote control has been pressed.
No picture or black and white picture	<ul style="list-style-type: none">◆ Adjust the color settings.◆ Check that the broadcast system selected is correct.
Sound and picture interference	<ul style="list-style-type: none">◆ Try to identify the electrical appliance that is affecting the television, then move it further away.◆ Plug your television into a different mains socket.
Blurred or snowy picture, distorted sound	<ul style="list-style-type: none">◆ Check the direction, location and connections of your aerial. This interference often occurs due to the use of an indoor aerial.
Remote control malfunctions	<ul style="list-style-type: none">◆ Replace the remote control batteries.◆ Clean the upper edge of the remote control (transmission window).◆ Check the battery terminals.

– AFTER SALES SERVICE

- Do not hesitate to contact your retailer or service agent if a change in the performance of your product indicates that a faulty condition may be present.

