

SAMSUNG

Operating Instructions

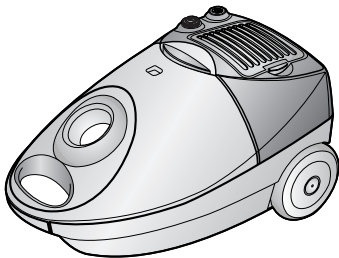

VACUUM CLEANER



- * Before operating this unit, please read the instructions carefully.
- * For indoor use only.

Register your product at www.samsung.com/register

IMPORTANT SAFEGUARDS

1. Read all instructions carefully. Before switching on, make sure that the voltage of your electricity supply is the same as that indicated on the rating plate on the bottom of the cleaner.
2. **WARNING** : Do not use the vacuum cleaner when rug or floor is wet.
Do not use to suck up water.
3. This appliance is not intended for use by persons (including children) with reduced physical, sensory or mental capabilities, or lack of experience and knowledge, unless they have been given supervision or instruction concerning use of the appliance by a person responsible for their safety. Children should be supervised to ensure that they do not play with the appliance.
4. Do not use the vacuum cleaner without a dust bag. Replace the dust bag before it is full in order to maintain the best efficiency.
5. Do not use the vacuum cleaner to pick up matches, live ashes or cigarette butts. Keep the vacuum cleaner away from stoves and other heat sources. Heat can deform and discolour the plastic parts of the unit.
6. Avoid picking up hard, sharp objects with the vacuum cleaner as they may damage the cleaner parts. Do not stand on the hose assembly. Do not put a weight on the hose. Do not block the suction or the exhaustion part.
7. Switch the vacuum cleaner off at the machine before unplugging from the electrical outlet. Do not pull on the cord to disconnect the plug from the electrical outlet. Ensure that it is disconnected before attending to the filter.
8. The plug must be removed from the socket out-let before cleaning or maintaining the appliance.
9. The use of an extension cord is not recommended.
10. If your vacuum cleaner is not operating correctly, switch off the power supply and consult an authorized service agent.
11. If the supply cord is damaged, it must be replaced by the manufacturer or its service agent or a similarly qualified person in order to avoid a hazard.
12. The vacuum cleaner is provided with a self-resetting thermal cut-out which automatically shuts off on over-heating. Overheating can be caused by blockage in the filter, nozzle, tube or hose. After removing the cause and allowing the motor to cool, the vacuum cleaner will automatically restart.

1 ASSEMBLING THE CLEANER

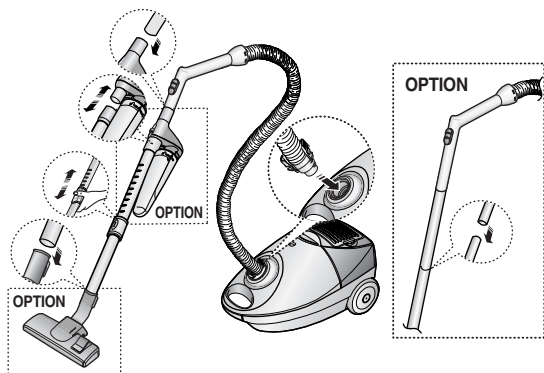

► Features may vary according to model.

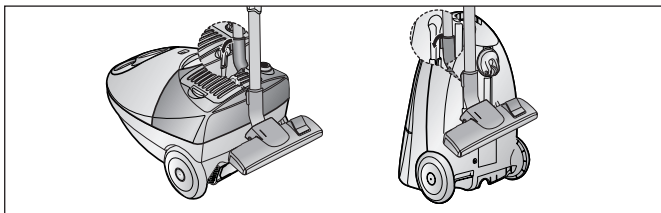

► For storage, park the floor nozzle.

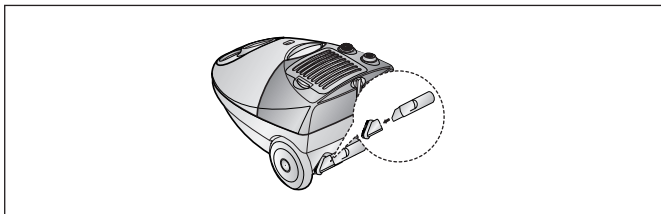

► Tool storage

2 OPERATING YOUR CLEANER

2-1 POWER CORD

- VOLUME TYPE



- ON/OFF TYPE

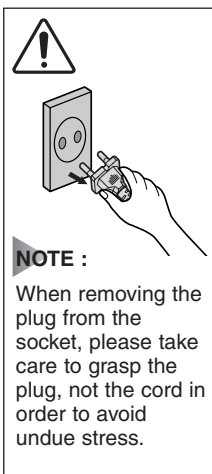
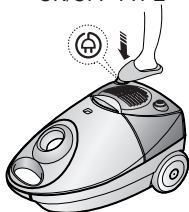

2-2 ON/OFF SWITCH

- VOLUME TYPE

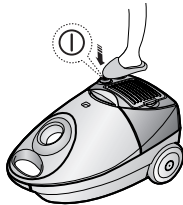

- ON/OFF TYPE

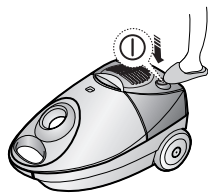

2-3 POWER CONTROL (VOLUME TYPE ONLY)

MIN = For delicate fabrics, e.g.
net curtains.

MAX = For hard floors and heavily
soiled carpets.



2-4 SUCTION CONTROL

To reduce suction for cleaning draperies,
small rugs and other
light fabrics, slide the air vent
until the hole is open.

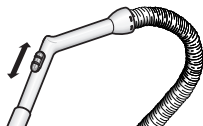

2-5 USING FLOOR TOOLS

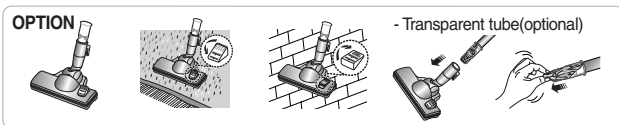
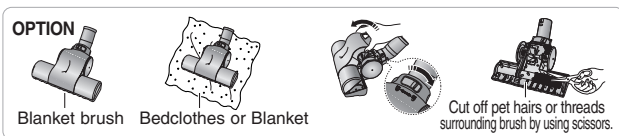
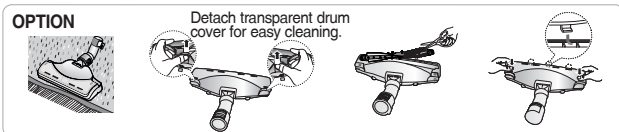
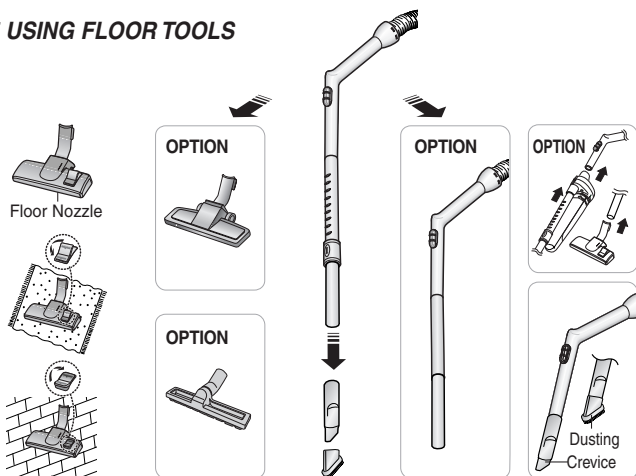

► Features may vary according to model.

DUSTING BRUSH

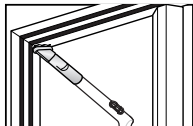

- Dusting brush for furniture, shelves, books, etc.

CREVICE TOOL

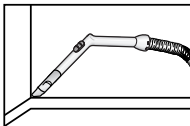

- Crevice tool for radiators, crevices, corners, between cushions.

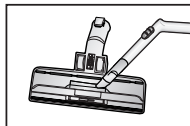

- For efficiency, clean Floor Nozzle with Crevice Tool.

3 INDICATOR LIGHTS

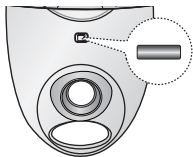

When the indicator color has changed
Please replace the dust bag.

3-1 CHANGING THE DUST BAG



3-2 FOR CLOTH BAG (OPTION)

After using, if the cloth bag is full of dust, clean the cloth bag and use it again.

WARNING : Please do not attempt to operate the cleaner without a dust bag fitted.

4 CYCLONIC FILTER(ONLY CYCLONIC FILTER TYPES)

You can use a dust bag in your cleaner for a long time thanks to the Cyclonic Filter system and it maintain the maximum cleaning efficiency.

The larger particle of dust filtered from Cyclonic Filter remain in Dust Barrel when suctioned air and dust revolves in the Cyclonic Filter. So the dust bag contains only smaller ones.

When the Dust Barrel is filled with dust up to the indicating line, it needs disposing and cleaning. Dust Barrel can be cleaned in water.

1. Turn the Dust Barrel to the left and pull it.
2. Disconnect the Cyclonic Filter from extension wand and handle.
3. Remove thread and hair tangled around the net.
4. After cleaning the Dust Barrel and Cyclonic Filter, connect the Cyclonic Filter with extension wand and handle(washed part should be dried in the shade thoroughly before assembling).
5. Push and turn the Dust Barrel to the right.

Adjust indicating marks each other carved on Dust Barrel and Cyclonic Filter.

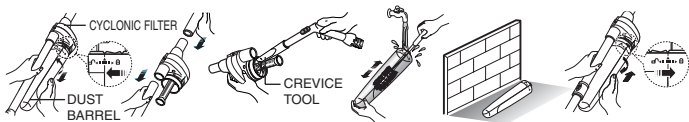

5 CLEANING THE INLET FILTER

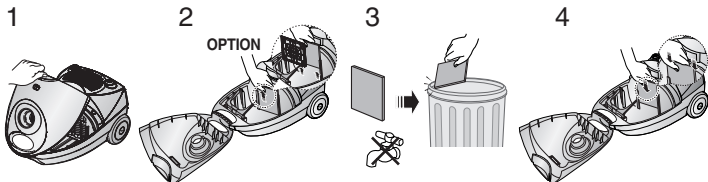

NOTE : Do not allow the filter to become clogged as this may cause power reduction or may damage the motor.

6 OUTLET FILTER (VOLUME TYPE ONLY)

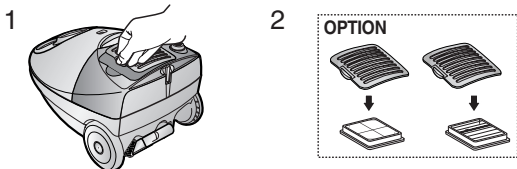

- IF YOU HAVE A PROBLEM

PROBLEM	CAUSE	REMEDY
Motor does not start.	No power supply. Thermal cut-out.	Check cable, plug and socket. Leave to cool.
Suction force is gradually decreasing.	Nozzle, suction hose or tube is blocked.	Remove the object.
Cord does not rewind fully.	Check that the cord is not twisted or wound unevenly.	Pull the cord out 2-3m and push down the cord rewind button.
Vacuum cleaner does not pick up dirt.	Crack or hole in hose.	Check hose and replace if required.

This Vacuum cleaner is approved the following.

EMC Directive : 2004/108/EEC

Low Voltage Safety Directive : 2006/95/EC

If you have any questions or comments relating to Samsung products, please contact the SAMSUNG customer care center.

Country	Customer Care Center ☎	Web Site
U.K	0845 SAMSUNG(7267864)	www.samsung.com/uk
SOUTH AFRICA	0860 7267864(SAMSUNG)	www.samsung.com/za